



The Global Language of Business

# GS1 Package Measurement Rules Standard

the global rules for nominal measurement attributes of product packaging to facilitate communication of the same for retail & non-retail products covering consumer unit to the case level & all intermediary levels

---

*Release 2.7, Ratified, Jan 2021*



## Document Summary

Document Item	Current Value
Document Name	GS1 Package Measurement Rules Standard
Document Date	Jan 2021
Document Version	2.7
Document Issue	
Document Status	Ratified
Document Description	the global rules for nominal measurement attributes of product packaging to facilitate communication of the same for retail & non-retail products covering consumer unit to the case level & all intermediary levels

## Log of Changes

Release	Date of Change	Changed By	Summary of Change
	Aug-2006	Zexia Huang	Initial Version
	Sep-2006	Justin Childs	Added Package Measurement Tolerances
	15- Sep-2006	Maria Victoria Caro	Added the Change Request approved by Barcodes & Identification BRG that affected the section 6.8 within General Specifications: CR 05-000212: Definition of consumer trade item versus non- consumer trade item. CR 05-000375: Clarify Unit Of Measure. CR 06-000083: Clarify Non-consumer Trade item/determining the Base
	30-Nov-2006	Ray Delnicki	CR 06-225 Approved 28-0, 06-226 Approved 25-3 and 06-228 Approved 28-0 by the GDSN Data Accuracy Work Group by eBallot on November 14 2006 pending Board Ratified During the January 2007 Quarterly BCS meeting
	25-Apr-2007	Ray Delnicki	CR 06-281 section 4.9 Package measurement rules added by Ray Delnicki of GS1 US for many different Soft products:
	25-Apr-2007	Rich Richardson	CR 06-296 section 4.10 Package measurement rules added by Rich Richardson of GS1 US for many different Hardlines products:
	22-May-2007	Ray Delnicki	CR 06-281 Pictures added to Softlines Products section 4.9



Release	Date of Change	Changed By	Summary of Change
	22-May-2007	Justin Childs	CR 06-246 Change to Figure 5-7 Dimensions of a Non-consumer Trade Items to add a Note <i>Figure 5-7 Figure 5-7</i>  <i>NOTE: The Natural Base rule is used to measure Unit Loads on Shipping Platforms. The height, width, depth, and gross weight of the shipping platform is not always included in the dimension information. To designate exclusion of shipping platform level measurements the PalletTypeCodeList code value must be set accordingly.</i>
	29-Jun-2007	Justin Childs	CR 06-253 Package Measurement Rules for Soft Paper products section
	30-Jul-2007	Justin Childs	CR 07-200 Soft Paper Tolerances were added to section 6 Table 6-1 & 6-2
	8-Aug-2007	Rich Richardson	CR 07-262 Hardlines Rules additions for Floor Board Moulding, Crown Moulding Product and Stair Way Products section 4.9.3
	5-Nov-2007	Mary Wilson	CR 07-425 Added Flexible Package Measurement Tolerances to section 6
	5-Nov-2007	Mary Wilson	CR 07-423 Added Flexible Package Rules To sections 4.5
	25-Jan-2008	Justin Childs	CRs 07-262, 07-425 and 07-423 Data Accuracy BRG Approved Jan-17-2008 and BCS Process Group Ratified on Feb-4-2008 with eBallot threshold for minimum voting members exceeded on all 3 Change Requests. Document Status changed to "Final" and date changed to "Feb-4-2008"
	14-Jul-2008	Rich Richardson	Added clarifications and corrections within section 4 (Consumer Trade Items) determining default front (4.2), hanging items (4.4), Flexible packaging (4.5), and Multi-packs (4.7) and added new section 4.11 for Large Flexible Packages. Modified table 6.3 (Standard Tolerances for Consumer Trade Items) to add product specific tolerances for Large Flexible Packages, and modified existing notes to same
	16-Sep-2008	Rich Richardson	Added "Exceptions to this rule have been made for trade items in flexible packaging". The exception is based on the conclusion by the pilot team that flexible packages (form filled and sealed without gussets) are to be measured laying down, edge to edge, regardless of whether they will be displayed standing up, hanging or laying down. Included updated graphic.
	19-Jan-2009	Justin Childs	Section 4.1 – Removed the specific section number from the General Specification reference.
	18-Jun-2009	Rich Richardson	Section 4.2 – Determination of Default Front: Added graphics and text to clarify determination exclusive of shelf orientation  Section 4.4 – Hanging items: Added clarification for measuring hanging items.  Section 5.3 – Non-Consumer trade items: Added clarification for measurement of Display Boxes, Shrink Packs, and Tray Packs  Sections 6.2 and 6.3 – Measurement tolerances: Rearranged existing information to provide additional clarity



Release	Date of Change	Changed By	Summary of Change
	31-Jul-2009	Justin Childs	Added tolerances for small packages to tables in section 6-3 and added clarification notes for same.
	29-Mar-2010	Steve Vazzano	Section 5 - Determining Natural Base for Buckets and Pails (CR 10-008) – Added second Paragraph to section 5.1 Overview on Non-consumer Trade Items and Added a new section 5.6 Bulk Loads on Shipping Platforms, Added a new section 5.7 Buckets and Pails Section 5.7.1 Determining Natural Base Buckets and Pails Section 5.7.2 Measuring Buckets and Pails
	29-Mar-2010	Rose Deluca	Section 4-2 Add a Drawing figure 4-5 to Update GDSN Package Measurement Rules in order to clarify the determination of Default Front for Consumer Trade Items that contain die cuts (CR10-14).
	2-June-2010	Gabriel Sobrino	Section 4.5.4 - Expand GDSN Package Measurement Rules to include other products that have a structural „base“ and a pyramidal or conical shape and should be measured according to the same principle applied to stand-up pouches (CR 10-099).
	15-Oct-2010	Nadine Radomski – Dean Foods	Section 6 - Add Case Level Tolerances for Frozen Packages based on the results from the Frozen Package Pilot to section 6.2 table 6-1 (CR 10-120).
	10-Jun-2011	Richard Richardson – GS1 US	Section 6 – Changed final footnote below the last table in section 6 on Frozen Flexible Cases to (and also the note in the Frozen Package consumer unit tolerance table figure 6-1 to) : <i>Consumer trade items that are shrink wrapped together to create a non- consumer trade item (e.g., cases) will utilise the larger of the applicable tolerances for the packaging type of the consumer trade item or the non-consumer trade item that is created.</i>
	2-Jan-2013	Errata – Justin Childs	Section 4.4.3 Replace All references to “Clip Strip” with “Merchandising Strip” because Clip Strip is a brand name.
	2-Jan-2013	Ray Delnicki – GS1 US	Add new section for Clamps, Loose Tools, Turn Saw & Accessories section 4.9.4
	2-Jan-2013	Peter Zaepfel – Kraft Foods Inc.	Section 6.2 Table add Case Level Tolerances for Very Small / Very Light Weight Products
	28-Oct-2013	Ray Delnicki GS1 US	Work Order #13-000028. These are unpackaged plumbing parts rules (section 4.9.5).
	Dec 2013	Ray Delnicki, GS1 US	Work Order #13-000076. Cheese wedge and wheel measurements (section 4.12)
2.0	Jul 2015	Valerie Hoste, GS1	Work Orders #14-000126 & 14-000190 and applied new GS1 branding prior to publication
2.0.1	Oct 2015	David Buckley, GS1	Errata fix, Figure 4-97
2.1	Oct 2015	Ray Delnicki, GS1 US	Work Order #15-0109 Improvement to measurement tolerance for variable measure (section 6.1)
2.2	Dec 2015	David Buckley, GS1	Work Order #15-185 update for small consumer items tolerance in section 6.3



Release	Date of Change	Changed By	Summary of Change
2.3	Feb 2016	David Buckley, GS1	Work Order #15-340 and 15-341 update for conversion best practice in section 3.1 and hanging items flexible packaging in section 4.5. Errata fix, section 6.2 and 6.3.
2.4	May 2016	David Buckley, GS1	Work Order #16-011 and 16-147 update for tolerance in section 6.2 & 6.3 and improvements in sections 4.2, 4.5 and 4.10.
2.5	Sep 2016	David Buckley, GS1	Work Order #16-267 and 16-316 update for calculation of surface for cylindrical items in section 4.2 and clarification for items intended for consumer items in section 4.1.
2.5.1	Jan 2017	David Buckley, GS1	Errata fix (WR16-514) section 5.7 & section 6.3.1
2.5.2	Feb 2017	David Buckley, GS1	Errata fix (WR17-010) table 6-1 & 6-2
2.5.3	Jan 2018	David Buckley, GS1	Errata fix (WR18-012) section 6.3.1 clarified to apply to rigid items only.
2.6	Feb 2019	David Buckley, GS1; Jorge Nava, GS1 Mexico; Ray Delnicki, GS1 US	WR 18-343 & 361 (update section 6.2) tolerance clarification and 18-217 (new section 4.13) usable measures. Name change from GDSN → GS1 Package Measurement Rules.
2.6.1	May 2019	Ray Delnicki, GS1 US	WR 19-176 errata fix in section 6.2 to add missing tolerance
2.7	Jan 2021	Dan Clark	WR 20-353 clarification in section 5.2 (determining natural base of non-consumer trade item) and editorial fixes.

# Table of Contents

<b>1</b>	<b>Preface .....</b>	<b>8</b>
<b>2</b>	<b>Introduction .....</b>	<b>8</b>
<b>3</b>	<b>Metric and imperial dimensions .....</b>	<b>8</b>
3.1	Linear measurements .....	8
3.2	Weight measurement .....	9
<b>4</b>	<b>Consumer (End-user) trade items .....</b>	<b>9</b>
4.1	Overview .....	9
4.2	Determining the Default Front of an item .....	9
4.3	Determining the height, width and depth.....	11
4.4	Hanging-item .....	12
4.4.1	Hanging items in rigid packaging .....	12
4.4.2	Hanging items in flexible packaging .....	13
4.4.3	Merchandising strips .....	13
4.5	Flexible packaging.....	14
4.5.1	Trade items in flexible packaging with no markings .....	14
4.5.2	Flexible packaging – Formed, filled, and sealed without gussets.....	15
4.5.3	Stand up pouches .....	15
4.5.4	Stand up packaging with leaning or irregular verticals.....	16
4.5.5	Flexible packaging – Size or shape defined by contents .....	16
4.5.6	Gusseted bags.....	17
4.5.7	Block bottom (Flat bottom) bags.....	18
4.6	Cylindrical items.....	18
4.7	Multi-packs .....	19
4.8	Product specific (Personal, decorative and sporting good) measurements .....	20
4.8.1	Overview .....	20
4.8.2	Apparel items.....	21
4.8.3	Footwear items.....	24
4.8.4	Bed & bath items .....	25
4.8.5	Window treatment items.....	27
4.8.6	Jewellery items .....	27
4.8.7	Accessory items.....	30
4.8.8	Kitchen items .....	32
4.8.9	Sporting good items.....	36
4.9	<b>Product specific (nursery stock and building materials) measurements .....</b>	<b>45</b>
4.9.1	Overview .....	45
4.9.2	Nursery stock, and their containers.....	45
4.9.3	Building products.....	48
4.9.4	Professional/Commercial tools and accessories .....	52
4.9.5	Unpackaged plumbing parts .....	53
4.10	Soft paper products with a vertical core – Paper towels & toilet paper .....	58
4.10.1	Overview .....	58
4.10.2	Determining the Default Front of soft paper products .....	58
4.11	Large flexible packages.....	59
4.11.1	Overview .....	59

4.11.2	Determining the Default Front of large flexible packages.....	59
4.12	Cheese wheel and wedge.....	59
4.12.1	Measurement of a wedge of cheese (wheel) .....	59
4.13	Determining the marketing/usable sizes .....	60
4.13.1	Usable diameter .....	61
4.13.2	Base measurement diameter.....	61
4.13.3	Usable height .....	62
4.13.4	Usable width .....	62
4.13.5	Usable depth.....	63
4.13.6	Usable length .....	63
<b>5</b>	<b>Non-consumer trade item .....</b>	<b>64</b>
5.1	Overview .....	64
5.2	Determining the natural base.....	64
5.3	Display boxes .....	66
5.4	Shrink packs.....	67
5.4.1	Tray packs .....	67
5.4.2	Floor ready displays .....	68
5.4.3	Unit loads on shipping platforms .....	68
5.5	Bulk loads on shipping platforms.....	68
5.6	Buckets and pails .....	69
5.6.1	Determining natural base for buckets and pails.....	69
5.6.2	Measuring buckets and pails.....	69
<b>6</b>	<b>Standards tolerances for data accuracy .....</b>	<b>70</b>
6.1	Overview .....	70
6.2	Standard tolerances for non-consumer trade items .....	70
6.2.1	Standard tolerance for very small non-consumer trade items .....	71
6.3	Standard tolerances for consumer trade items.....	72
6.3.1	Standard tolerances for very small rigid consumer trade items.....	73
6.4	General notes on standards tolerances.....	74
<b>A</b>	<b>Appendix: Stair parts and definitions.....</b>	<b>75</b>

## 1 Preface

This document sets the standard for the global, unambiguous definition of nominal measurement attributes of product packaging to facilitate communication of the same for retail and non-retail products from the consumer unit to the case level and all intermediate packaging levels in between. This standard is intended to provide a consistent, repeatable process to determine measurements for a given product package; and may not represent the “as merchandised” or shelf orientation of the product. Any, more restrictive, local regulations governing the measurement of either weight or dimensions take precedence over these specifications.



**Attention:** This standard is intended to provide a consistent and repeatable process for determining the dimensions of any given product packaging; however, they do not necessarily correspond to how the product is presented on the shelves or in promotional material.

When a new Global Trade Item Number<sup>®</sup> (GTIN<sup>®</sup>) is assigned to a trade item, it is essential that the party allocating the number, normally the manufacturer, provide detailed information to trading partners about the characteristics of the new trade item. This information should be provided as soon as possible before the product is actually traded and should include details such as brand name, net weight, packaging materials, package measurements, etc.

## 2 Introduction

The accurate and consistent dimensional measurement of trade item packaging is key to the successful implementation of Data Synchronisation between trading partners. This standard is provided for use for all trading partners wishing to exchange data about product package measurements. This common methodology for determining product package measurements is intended to ensure global compatibility. Suppliers may use any valid unit of measure (UOM) and it is up to their trading partners to convert the UOM between increments within a measurement system (e.g., millimetres versus centimetres, pounds versus ounces, or inches versus feet). For imperial and metric, suppliers should provide the measurement system that is required in a specific target market.

## 3 Metric and imperial dimensions

Suppliers may use any valid unit of measure (UOM) and it is up to their trading partners to convert the UOM between increments within a measurement system (e.g., millimetres versus centimetres, pounds versus ounces, or inches versus feet). For imperial and metric, suppliers should provide the measurement system that is required in a specific target market. The level of precision is left to the discretion of the user.

The following rounding guidelines have been established as the minimal level of precision required.

### 3.1 Linear measurements

For linear dimensions, the following measurements are rounded up, decimal placement is specified below:

- Millimetres are always rounded up to a whole millimetre. For example 99.3 mm would become 100 mm.
- Inches are always rounded up to the nearest 0.05 of an inch. For example, 2.932 inches would become 2.95 inches.

When exchanging data between trading partners using different systems (i.e., metric vs. imperial), the following conversion ratios must be used:

- 1 inch = 25.4 mm
- 1 mm = 0.03937 inches

- !** **Important:** When conversion between systems of measurement is necessary, the best practice is to first perform the conversion and then secondly apply the rounding rules above. This ensures the greatest level of accuracy and consistency for linear dimensions values.

The three linear dimensions shall be measured using the same measuring system and the same unit of measure (i.e., all millimetres /centimetres or all inches/feet). It is the manufacturer of the product who decides which system of measurement and unit of measure is used when providing linear dimensions

## 3.2 Weight measurement

For weights, the level of precision is left to the discretion of the user and to applicable local laws. If rounding is required, all weight measurements are to be rounded up to match that level of determined precision.

Conversions are made using the following conversion ratios:

- 1.000 Pound (avoirdupois) = 0.454 Kilograms
- 1.000 Kilogram = 2.205 Pounds (avoirdupois)

# 4 Consumer (End-user) trade items

## 4.1 Overview

Consumer trade items are identified with a GTIN. For the retail channel, these items to be measured as consumer trade items will fulfil these three criteria:

- They are meant to pass through Point of Sale
- They have a Default front
- If the item is barcoded, it will be marked according to the Symbol Specification Tables for Retail Items (per the GS1 General Specifications)

- !** **Important:** If the information provider has determined that the trade item is a consumer unit, then measure per section [4](#).

For Example: Whether a trade item is considered a consumer unit by the supplier is indicated in GDSN by populating the attribute *isTradeItemAConsumerUnit* with the value "True". Consumer units must have a barcode symbol suitable for the point-of-sale.

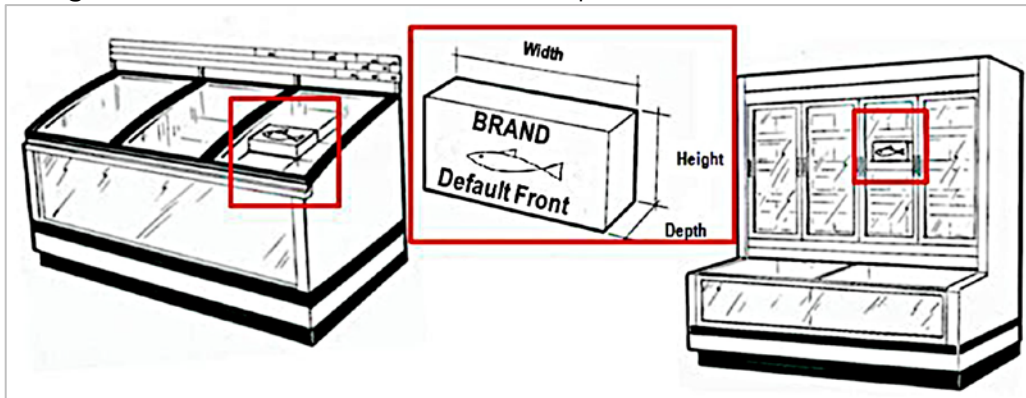
If a consumer trade item is also traded as a Logistics trade item, it still needs to be viewed as a consumer trade item and measured accordingly.

## 4.2 Determining the Default Front of an item

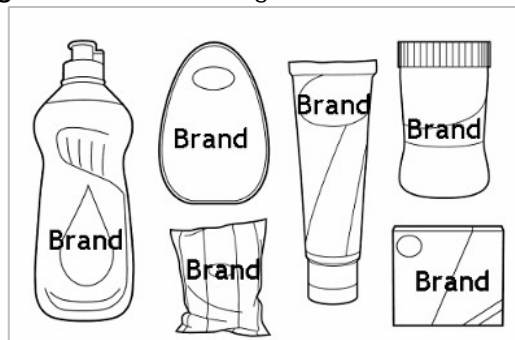
Prior to any measurement capture, the Default Front of the trade item must be determined. For the purposes of this standard, the Default Front is the surface with the largest area that is used by the manufacturer to "sell" the product to the consumer, in other words, the surface with markings such as the product name and standard text elements such as Consumer Declaration (e.g., Net Content).

- !** **Important:** The determination of Default Front is intended to provide a consistent, repeatable process to determine measurements for a given product package and may not always represent the "as merchandised" or shelf orientation of the product as illustrated below:

**Figure 4-1** Default front is determined independent of shelf orientation

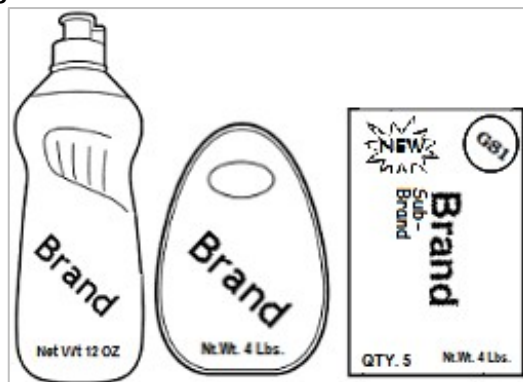


**Figure 4-2** Determining the default front of an item



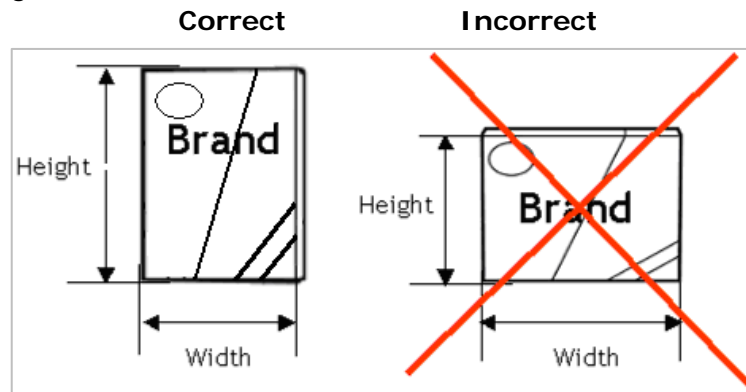
When Determining the Default Front, standard text elements such as Consumer Declarations should be viewed horizontally as product branding and/or graphics may not be consistent with a horizontal or vertical orientation. If there are two like surfaces that could be Default Front, one containing standard text elements such as Consumer Declaration (e.g., Net Content) and the other without, Default Front will be the surface containing the standard text element such as Consumer Declaration (e.g., Net Content).

**Figure 4-3** View standard text elements horizontally



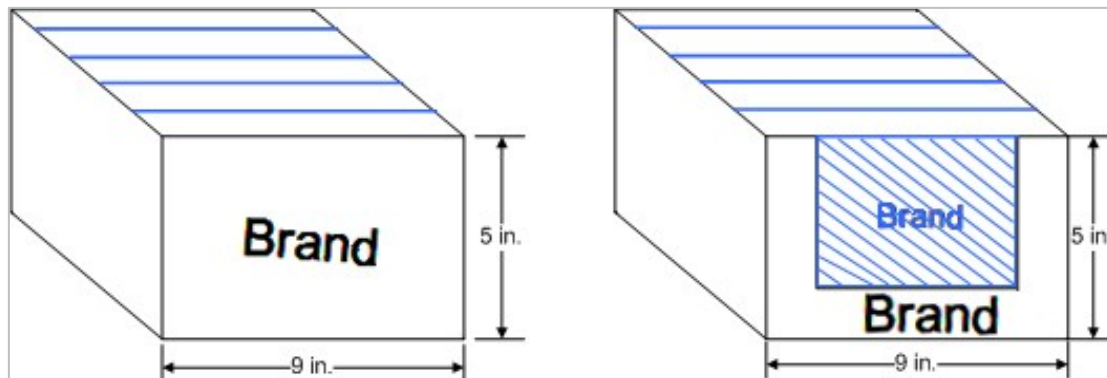
Some product packages have more than one possible front with the same surface area. These products can be presented both vertically and horizontally on the shelves. If a product package has more than one possible front, the highest side is considered to be the Default Front.

**Figure 4-4** Determining default front of an item with more than one front with the same surface areas  
 Highest side as Default Front      Widest side as Default Front



**!** **Important:** See additional specifics on Default Front for Multipacks in section [4.7](#).

**Figure 4-5** Determining Default Front of an Item where die cuts impact total surface area outside measurements are used to determine default front



Die cuts in product packaging **DO NOT** impact the determination of Default Front as the exposed product is considered to be a part of the surface area that is used by the manufacturer to „sell“ the product to the consumer.

**✓** **Note:** Once the Default Front has been determined, calculating the surface for rectangular products is simple. However, for non-rectangular trade items (for example, products with a cylindrical or irregular form) the method to calculate the surface is:

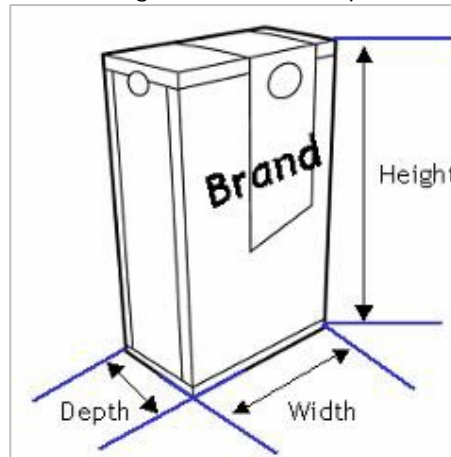
- i. in case of a round lid the surface is not equal to the circle area ( $=\pi*r^2$ ), but is equal to the “two dimensional” rectangle drawn around the circle.
- ii. in case of a round cup the surface is not equal to height x half the circumference ( $=\pi*r$ ), but is height x width.

### 4.3 Determining the height, width and depth

After the Default Front has been determined, it is possible to determine the height, width and depth of an item. While facing the Default Front:

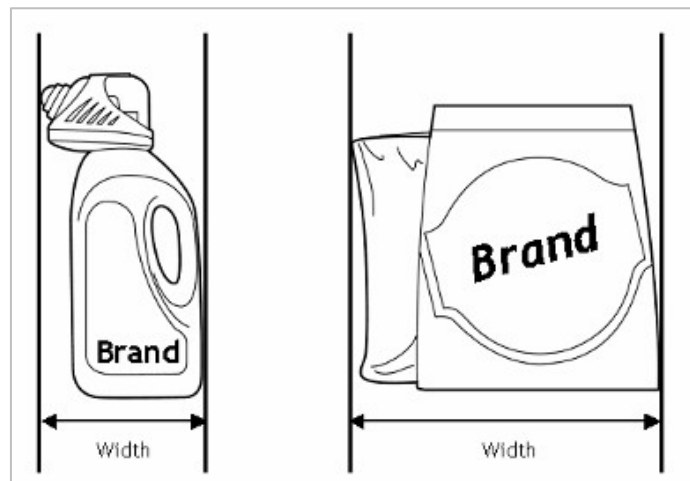
- Height: from the base to the top
- Width: from the left to the right
- Depth: from the front to the back

**Figure 4-6** Height, width and depth of an item



After the height, width and depth have been determined, the dimensions can be measured. Always measure the maximum distance, i.e. include things such as projections, caps, lids and complimentary products (e.g., on-packs, collectables, or samples) in the measurement.

**Figure 4-7** Always measure the maximum distance



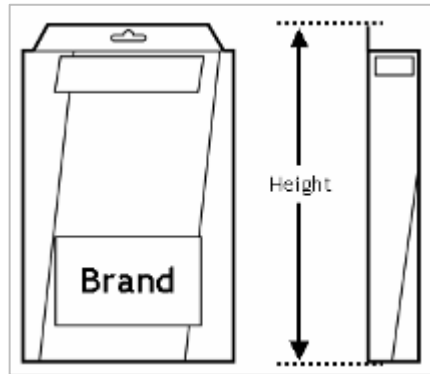
## 4.4 Hanging-item

A Hanging-Item is a trade item that is presented on a hanger or contains a hole for hanging purposes. Three measurement methods exist for hanging items based on the packaging type:

### 4.4.1 Hanging items in rigid packaging

Measure the trade item while facing the Default Front as if it were hanging. Measure the maximum distance including the hanger tab.

**Figure 4-8** Always measure rigid hanging items as if hanging



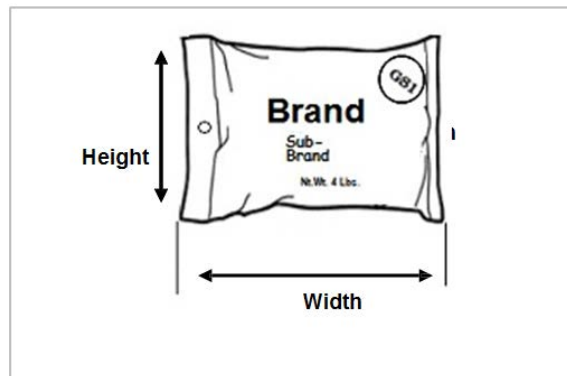
#### 4.4.2 Hanging items in flexible packaging

This rule regarding hanger holes does not apply to flexible packaging. For specific guidance regarding flexible packaging, please see section [4.5](#).



**Important:** The hole or hanging orientation is not used to determine the Default Front.

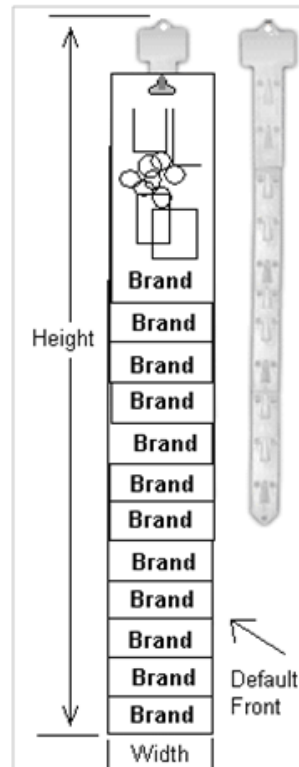
**Figure 4-9** Hanging trade item in flexible packaging



#### 4.4.3. Merchandising strips

Merchandising strips are hanging, display items that carry multiples of consumer trade items, and are identified with a GTIN. Clip strips are measured as if hanging using the rules for consumer trade items even if the clip strip is not marked for crossing point of sale. The Default Front is considered that surface seen while the clip strip is hung with product for display (see the figure below). Measure the maximum distance including the hanger tab.

**Figure 4-10** Merchandising strip (hanging display) flexible packaging



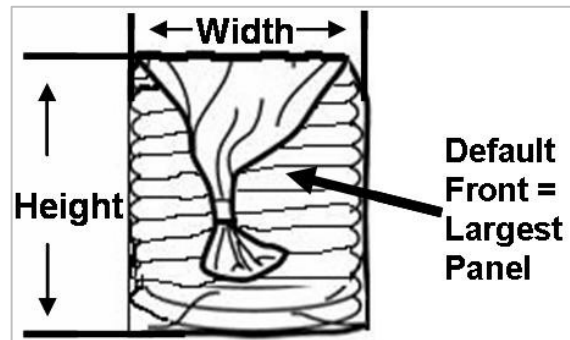
## 4.5 Flexible packaging

Flexible packaging is defined as any package or part of a package the shape of which can be readily changed. Flexible packaging includes but is not limited to bags, pouches, and wraps utilising paper, plastic, film, metallised or coated paper or film, or combinations of these materials. Consumer trade items in flexible packaging should be measured lying flat with the contents settled unless a specific exception is noted in the sections following.

This standard is intended to provide a consistent, repeatable process to determine measurements for a given product package and may not represent the “as merchandised” or shelf orientation of the product.

### 4.5.1 Trade items in flexible packaging with no markings

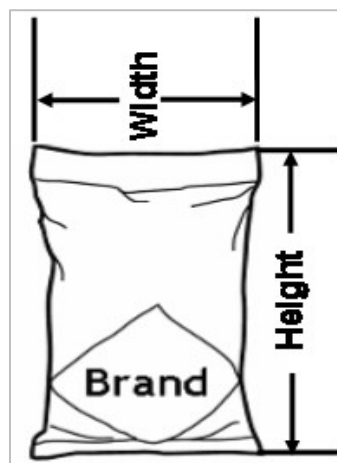
Trade items in flexible packaging with no markings may be in various package types, and hence should adhere to the measurement rules defined in the appropriate section of [4.5](#).

**Figure 4-11** Flexible packages with no markings


#### 4.5.2 Flexible packaging – Formed, filled, and sealed without gussets

Consumer trade items which are formed, filled and sealed without gussets (triangular seams or sealing pattern for bags or pouches used to create corners) will be measured edge to edge including the sealed seams with the item lying flat after evenly settling the contents. The measurements are taken while facing the trade item's Default Front, and after having pulled out and then released the seams. This rule applies to packaging whose contents are loose and granular, such as bagged loose candies, screws, nuts, bolts, dry pet food, rice, etc.

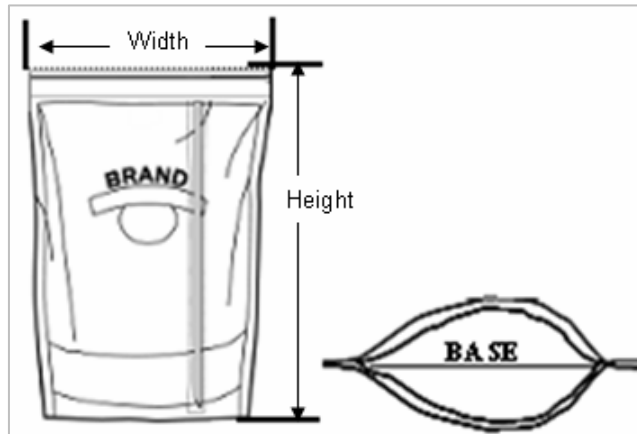
Height is the measurement from the bottom most point to the top most point, Width is measured from the left most point to the right most point and Depth is measured from the Default Front to the flat surface the trade item is lying on. Examples of this type of trade item include bags of chips, snacks and candy.

**Figure 4-12** Formed, filled, and sealed without gussets


#### 4.5.3 Stand up pouches

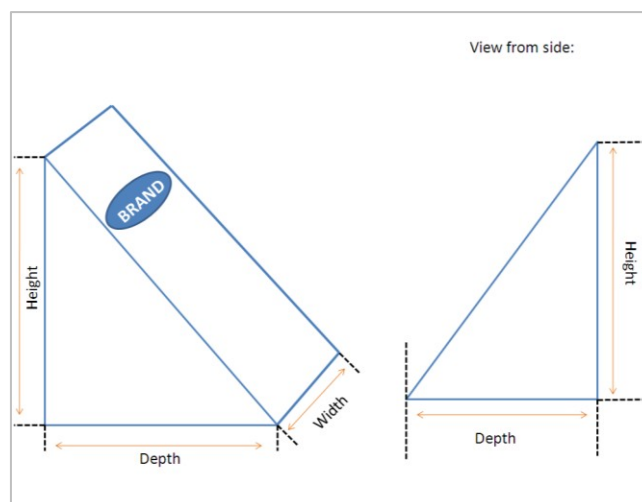
This section describes stand up pouches where the seal or seam is intended to serve as a base, which allows the item to stand up on its end. These trade items will be measured while standing upright on a flat surface facing the default front from edge to edge including seal seams.

Height is from the flat surface to the top most point, Width is from the left most point to the right most point and Depth is from the Default Front to the farthest opposite surface. Examples of this type of trade item include pouches of nuts, beverages and snacks (see figure below).

**Figure 4-13** Stand up pouches


#### 4.5.4 Stand up packaging with leaning or irregular verticals

This section applies to items which have a rigid or semi-rigid packaging that drive a specific shape for the product that includes a base on which the product can stand and be displayed in a natural position. The edges that rise vertically from the base, however, are not vertical and may lean inwards to form a pyramidal or conical shape for the product. These trade items will be measured while standing naturally on their base (upright on a flat surface facing the default front). Note: the default front may not be perfectly vertical as it may be located on the leaning face of the product. Height will then be the measurement from the flat surface to the top most point (parallel to the vertex), Width is from the left most point to the right most point and Depth is from the Default Front to the farthest opposite surface. Examples of this type of trade item include ready to eat sandwiches and confectionary items.

**Figure 4-14** Stand up packaging with leaning or irregular vertical


#### 4.5.5 Flexible packaging – Size or shape defined by contents

Consumer trade items in flexible packaging where the size or shape of the trade item is defined by its contents will be measured by folding the excess flexible material (if any) to the product and then measuring the trade item per section 4. See sections below for additional clarification and specific packaging examples.

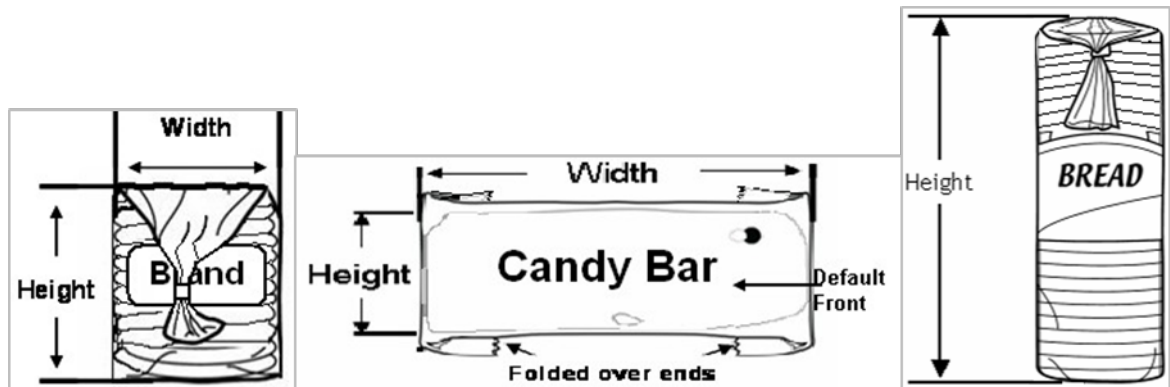
#### 4.5.5.1 Product or internal packaging that defines the size and or shape of the package

This section describes trade items where the contents of the trade item's flexible package contain product or internal packaging that uniformly defines the size and/or shape of the package. This can occur, for example, when the packaging material is less stiff than its contents. The trade item will be measured by folding the excess flexible material (if any) to the product and then measuring the trade item. These trade items may or may not be further contained by a tray or box intended for shelf display.

Measurements are made facing the Default Front while the trade item is on a flat surface such as a table oriented in such a way as the product or internal packaging allows for the product to set naturally. Height is from the bottom most point to the top most point; Width is from the left most point to the right most point and Depth is from the Default Front to the farthest opposite surface.

Examples of this type of trade item include, but are not limited to, candy bars, snack bars, cookies in trays, disposable cups, bread, rice cakes and vacuum packed items such as cheese or coffee (see figure below).

**Figure 4-15** Product or internal packaging that defines the size and or shape of the package



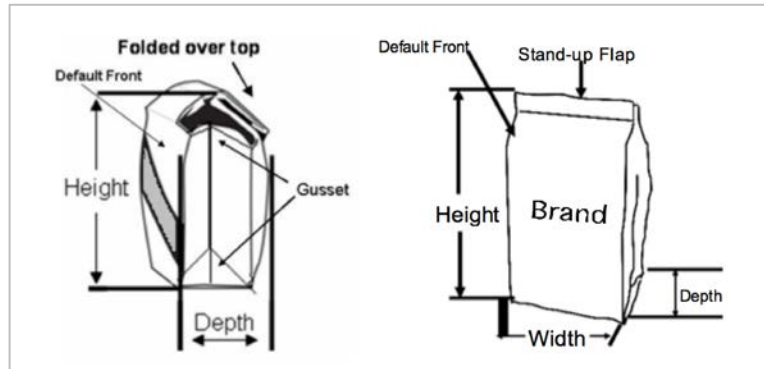
#### 4.5.6 Gusseted bags

This section describes trade items, which are gusseted bags with a declared net content of fifteen pounds (6.8 kilograms) or less. The gussets (triangular seams or sealing pattern for bags or pouches used to create corners) may be on one or both ends of the trade item, bottom gussets are designed to provide a base. These trade items are measured standing with the intended base on a flat surface such as a table, while facing the Default Front.

**!** **Important:** The height of the trade item will be measured with package head-space extended, with the exception that if the material is not rigid enough to stand by itself on the package head/flap is folded over. This rule applies only to gusseted bags.

Height is from the flat surface to the top most point, Width is from the left most point to the right most point and Depth is from the Default Front to the farthest opposite surface. Examples of this type of trade item include pet food, cat litter, and charcoal, coffee, pasta and snack foods.

**Figure 4-16** Gusseted bags Default Front



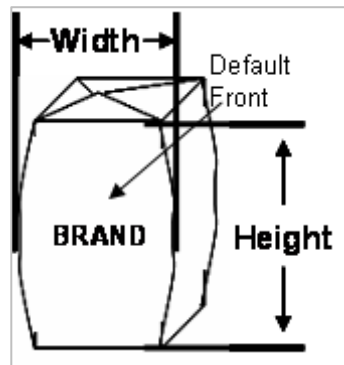
#### 4.5.7 Block bottom (Flat bottom) bags

This section describes trade items with a block or flat bottom (a tucked and sealed base, which allows the filled and sealed package to stand on its base). These trade items are measured standing with the intended base on a flat surface such as a table, facing the Default Front.

Height is from the flat surface to the top most point, Width is from the left most point to the right most point and Depth is from the Default Front to the farthest opposite surface.

Examples of this type of trade include flour, sugar, and salt.

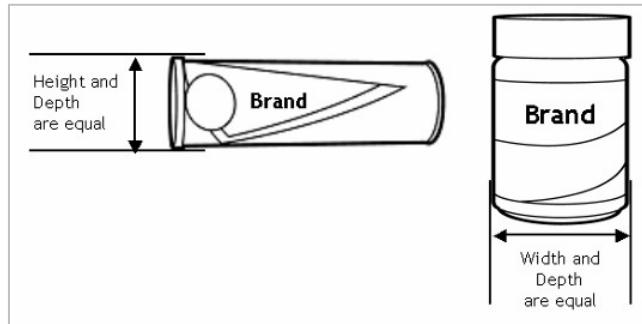
**Figure 4-17** Block bottom (flat bottom) bags



#### 4.6 Cylindrical items

For cylindrical items two dimensions will be nominally equal. Which dimensions are equal is determined by the result of determination of the Default Front for the consumer trade item.

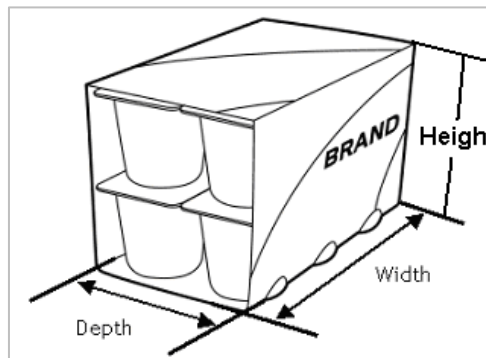
**Figure 4-18** Cylindrical item measurements



#### 4.7 Multi-packs

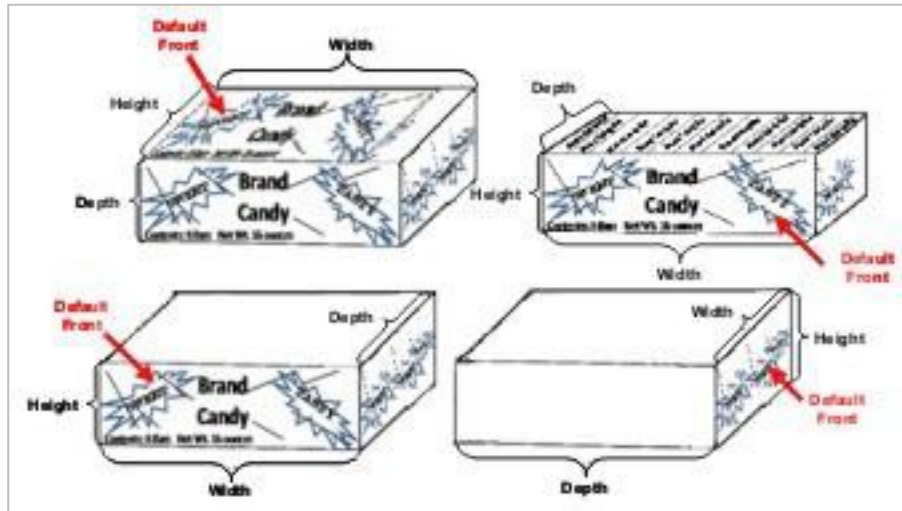
Multi-packs (known in GDS terms as inner packs if the component is carrying a GTIN) are consumer trade items themselves but contain a multiple of single items that may or may not be sold individually to the consumer. When a trade item meets the definition of a multi-pack it will be measured according to the Default Front rule in section 4 for consumer trade items.

**Figure 4-19** Determine the default front of a multi-pack



The Default Front of a Multi-pack must be determined based on the side with the largest surface area that is used by the manufacturer to „sell“ the product to the consumer, in other words, the side with markings such as the product name. As shown below, product graphics may significantly impact the determination of the Default Front and the resulting measurements.

**Figure 4-20** Graphics impact on determination of default front



## 4.8 Product specific (Personal, decorative and sporting good) measurements

### 4.8.1 Overview

This section covers the measurement of items in the following categories: Apparel, Footwear, Bed and Bath, Window Treatments, Jewellery, Personal Accessories (wallets, belts, handbags etc.), Kitchen and Sporting Goods. This section covers only consumer trade items.

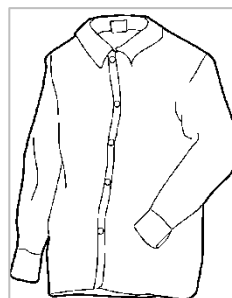
#### 4.8.1.1 Natural state and defined state

There is a need to further define these items beyond the terms consumer trade item and non-consumer trade item. These items exist in two states for Consumer Trade items- "Natural State" and "Defined State".

#### 4.8.1.2 Natural state

Natural State is the condition an item appears in as it comes off a production line. It is lacking any format or material to organise it or hold it in any particular shape. It is an unpackaged item.

**Figure 4-21** Natural state

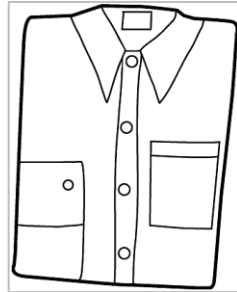


#### 4.8.1.3 Defined state

Defined State is the condition that a consumer trade item is in after it has been given shape or is held to a particular format. The methods to accomplish this are, but not limited to packaging the item either in part or whole, by folding or banding, by putting the item on a hanger or attaching to a hang card.

When a Defined State is the packaging encompassing the product, measurement is done according to the existing Package Measurement Rules with exception of flexible packaging. Items in this section, packaged in flexible packaging, are measured in their entirety.

**Figure 4-22** Defined state



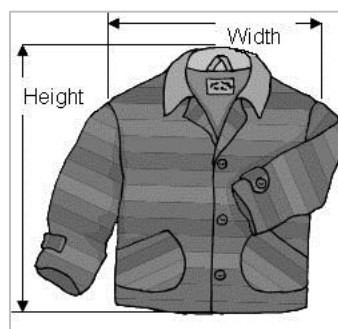
#### 4.8.1.4 Additional attributes

Because of the variety of states an item may be shipped in, the need for an additional attribute/package state has been identified. This attribute is an enumerated list to include: Loose, Folded, on a hanger, Banded and Packaged.

#### 4.8.2 Apparel items

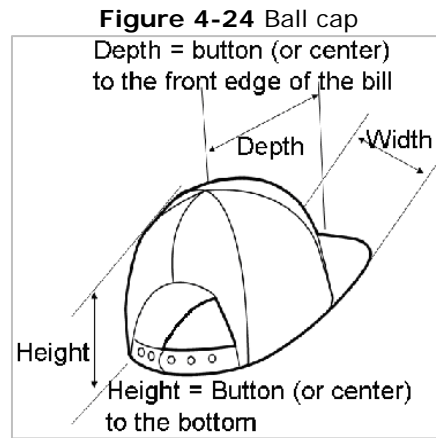
These items will be measured in their Natural State as if they have been laid on a table having come directly from the manufacturing line. Some apparel items have an obvious front as defined by their use and are measured while facing that front. Examples of items that would have an obvious front would be a button up shirt, a coat, a pair of trousers etc. The front being that surface that corresponds to the human front. In general terms, the Height of an apparel item that has an obvious front would be from the bottom most point to the top most point, the Width would be the left to right measurement, and the Depth would be the thickness.

**Figure 4-23** Apparel Item



##### 4.8.2.1 Ball caps

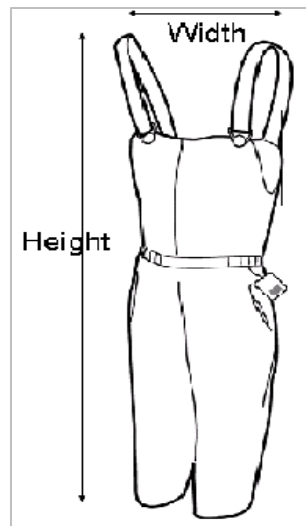
Ball caps are measured sitting on a flat surface, bill down. The Height is from the bottom to the button or the highest point on the cap. The Width is the widest left to right measurement while facing the bill. The Depth is from the button or centre of the cap to the front edge of the bill.



#### 4.8.2.2 Apparel with straps

Measurements are taken with the straps hooked and adjusted to the shortest length.

**Figure 4-25 Apparel with straps**



#### 4.8.2.3 Shirts, jackets, etc.

Width measurement is taken from shoulder to shoulder- either seam to seam or natural shoulder.

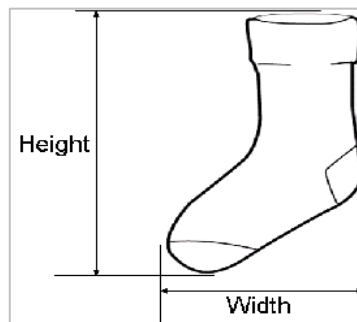
**Figure 4-26** Shirts, jackets, etc.



**4.8.2.4 Socks**

Measured with the sock opening, where the foot enters, in a horizontal orientation.

**Figure 4-27** Sock



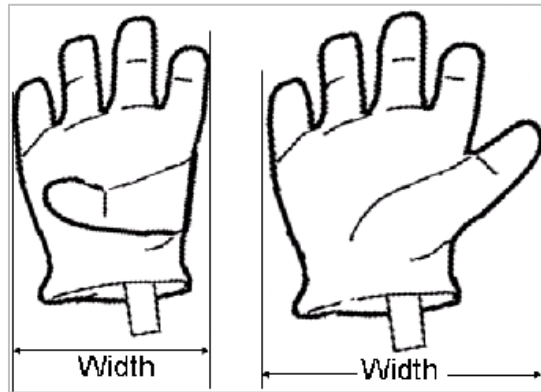
**4.8.2.5 Multi-piece sets**

Multi-piece sets (such as a two piece bathing suit) do not have a relevant Natural State, and are measured in a Defined State.

**4.8.2.6 Gloves**

Some gloves (such as utility gloves) are made with the thumb sticking out and others (such as dress gloves) are made with the thumb folded back into the palm. Measure as the thumb is made to fall, thumb in or out.

**Figure 4-28** Gloves

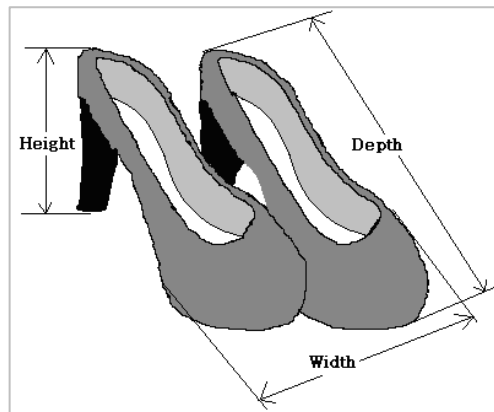


**4.8.3 Footwear items**

Shoes and boots etc. will be measured in pairs. The Default Front of Footwear in the Natural State will be facing the toes of the shoes, with the shoes side by side touching each other, sitting on a flat surface such as a table. Height is from the flat surface to the highest point of the shoe, Width is the from the left most point to the right most point facing the toes while the shoes are side by side in a pair, touching each other and the depth is from the front of the toe to the farthest rear-ward point of the heel.

Tall, soft footwear such as boots may tend to have the leg area “fold over”. This would represent a Natural State and would be measured as folded over. Boots that have card inserts to stand the leg area up would be in a Defined State and measurements traded as Defined State. The Package Measurement Rules will prevail for other methods of packaging.

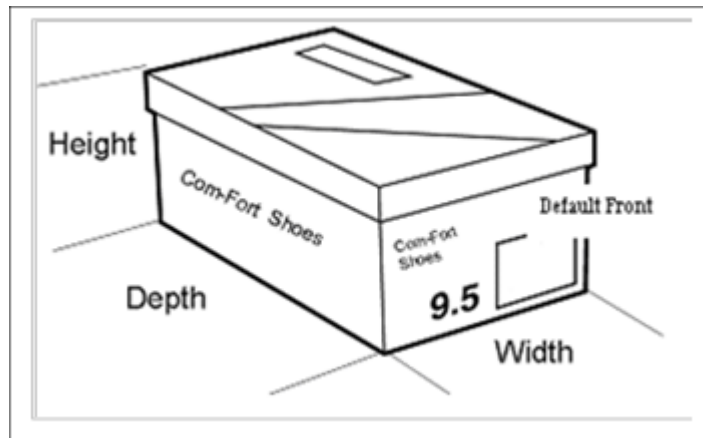
**Figure 4-29** Footwear



The Default Front of Footwear packaged in a shoebox will be the end of the box, since this surface contains brand, model, size, colour and the POS barcode.

### 4.8.3.1 Shoebox measurement

Figure 4-30 Shoebox measurement



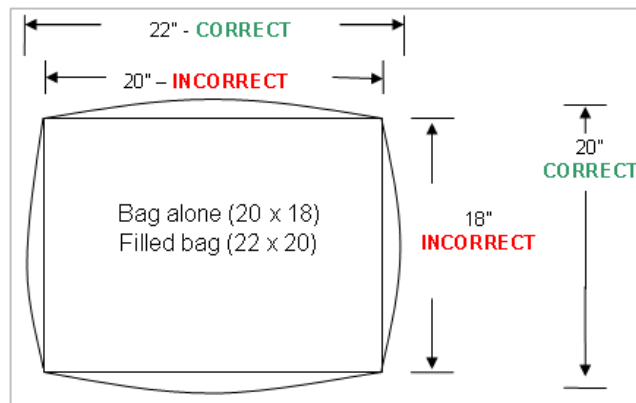
### 4.8.4 Bed & bath items

#### 4.8.4.1 Bed linen sets

Bed linens in their Natural State are measured viewed on a bed as from the foot of the bed. Measurements of components of sets will be detailed in the extended description field. A comforter is measured as height from the foot to the head of the bed.

When packaged, note that the contents tend to expand the packaging. Dimensions need to be of the expanded packaging and not the dimensions of the packaging itself.

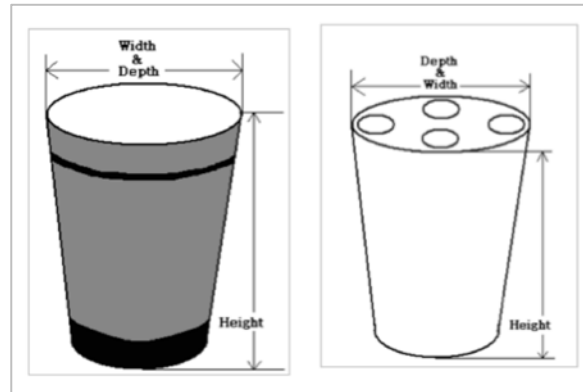
Figure 4-31 Bed linens



#### 4.8.4.2 Bath accessories

This category includes soap dishes, waste baskets, toothbrush holders, lotion/soap dispensers, tissue covers, tumblers, bowl brushes, paper cup dispensers, trays, boxes, jars, guest towel holders etc. When these items are unpackaged they are in the Natural State and are to be viewed for measuring as they would sit for use (e.g., a tumbler sitting on its base, a stand-up towel holder standing on its base). With the item sitting for use on a flat surface such as a table, if there is no apparent Default Front, face the largest left to right dimension as the Default Front and measure as the Width, the Base to the top-most point to be the Height, the front to back measurement to be the Depth.

**Figure 4-32 Bath accessories**



#### 4.8.4.3 Towels

In their Natural State, towels are laid out on a flat surface such as a table for measuring. The longest measurement is the Height, the next longest measurement is the Width and the thickness is the Depth.

When towels are in a Defined State they will be identified by the attribute as Loose, Folded, Hangered, Banded or Packaged. If there is no apparent Default Front in the Defined State, the longest measurement is to be the Height, the next longest is to be the Width and the third dimension is to be the Depth. The measurements for towels are taken "hem to hem". Fringe or decorative ornamentation is not measured.

#### 4.8.4.4 Rugs

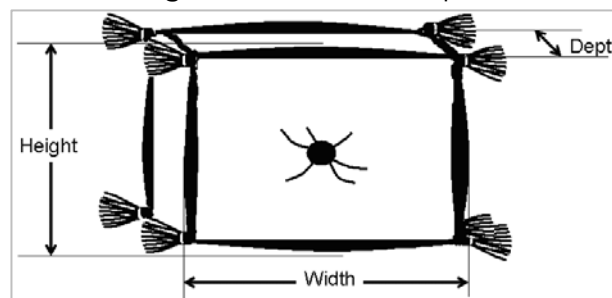
In their Natural State, rugs will be laid out on a flat surface such as a table for measuring. The longest measurement is the Height, the next longest measurement is the Width and the thickness is the Depth.

When Rugs are in a Defined State they will be identified by the attribute as Loose, Folded, Hangered, Banded or Packaged. If there is no apparent Default Front the longest measurement is the Height, the next longest is the Width and the third dimension is the Depth. Rugs that are rolled and taped would have the attribute "Banded". The measurements for rugs will be taken "hem to hem". Fringe or decorative ornamentation is not measured.

#### 4.8.4.5 Decorative pillows

Natural State measurements are to be taken while the pillow is sitting on its longest axis, facing the largest surface as the Default Front. The longest measurement is to be the Width, the top to bottom measurement is to be the Height, and the front to back measurement is to be the Depth. Decorative fringe or tassels are not to be measured.

**Figure 4-33 Decorative pillows**



## 4.8.5 Window treatment items

### 4.8.5.1 Valances, draperies

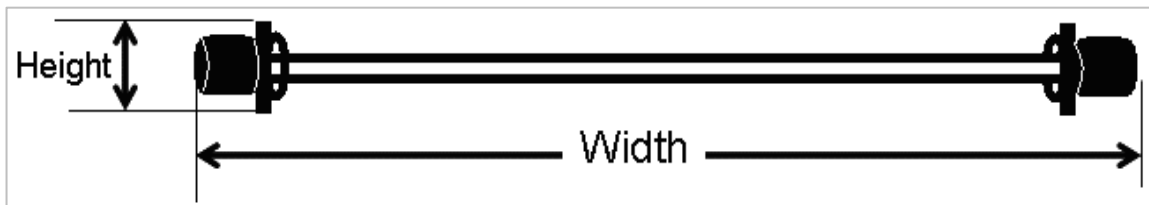
In their Natural State valances are laid out on a flat surface such as a table. Multiple valances are laid side by side. Height is measured from the top seam of the rod pocket to the bottom. The left-most point to the right-most point is the Width, the thickness is the Depth. Measurements do not include tassels or other ornamental trim.

### 4.8.5.2 Decorative drapery rods

Natural State measurements are taken while viewing the rod oriented horizontally. Width is the left to right (the longest) measurement. Height is the top-most point to the bottom-most point. Any finials are part of the measurement. Defined State measurements are taken while viewing the rod vertically. The Height is the top-most point to the bottom-most point. Width is the left-most point to the right-most point. Depth is the front to back measurement. Variable length rods are measured in their compressed state. Spring rods are not to have their springs compressed.

Other packaged drapery hardware is measured per the Package Measurement Rules.

Figure 4-34 Drapery Rod



## 4.8.6 Jewellery items

Jewellery is generally divided into the categories, Fine and Fashion. Fine jewellery is shipped packaged in a Defined State and displayed in a Natural State under glass. Fashion jewellery is shipped and displayed in a Defined State.

### 4.8.6.1 Jewellery defined state measurements

#### 4.8.6.1.1 Jewellery in a two piece box

The Default Front is the smallest surface (while sitting on its base- the surface opposite the opening side) following the model of the shoebox measurements. The Height is the bottom- most to top-most measurement. Width is the left to right measurement; Depth is the front to back measurement.

#### 4.8.6.1.2 Jewellery in a hinged box

The Default Front is the surface opposite the hinge. Hinged boxes are measured closed, Height is the bottom to top measurement, Width is the left to right measurement and Depth is the front to back measurement.

#### 4.8.6.1.3 Jewellery in a poly bag

The Default Front is the largest, highest panel. Height is the overall top to bottom measurement, Width is the overall left to right measurement and Depth is the front to back measurement.

#### 4.8.6.1.4 Items that are carded or using a header card

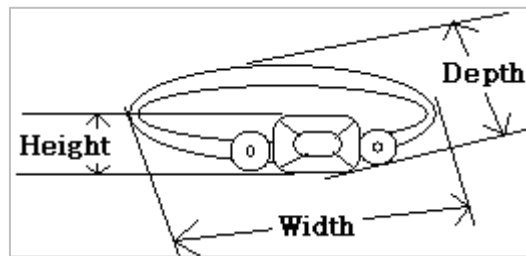
These items are measured according to the Package Measurement Rules.

#### 4.8.6.2 Jewellery natural states

##### 4.8.6.2.1 Rings

The Default Front is the front of the ring if viewed on the hand. Measure the ring resting on a flat surface such as a table, facing the Default Front. Height is the top to bottom measurement, Width is the left to right measurement and Depth is the front to back measurement.

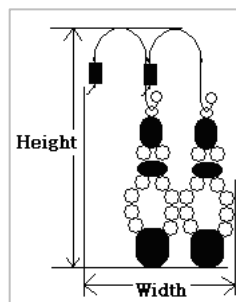
Figure 4-35 Ring



##### 4.8.6.2.2 Earrings

The Default Front is as viewed in the ear. Earrings, if in a pair, are measured as a pair, side by side sitting on a flat surface such as a table. Height is the top to bottom measurement, Width is the left to right measurement and Depth is the front to back measurement.

Figure 4-36 Earrings

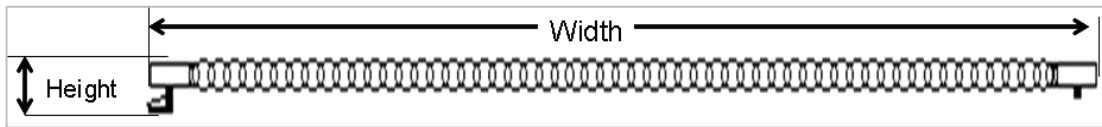


##### 4.8.6.2.3 Bangle bracelets

The Default Front is the front of the bracelet as it appears on the wrist. Measure the bracelet resting on a flat surface such as a table. Height is the top to bottom measurement, Width is the left to right measurement and Depth is the front to back measurement.

##### 4.8.6.2.4 Straight line chain

This category includes strands of pearls and other straight line jewellery. The Width is the effective length of the chain, clasp to clasp. A 14" chain would snugly fit a 14" neck. The Height is the top to bottom measurement when laid out on a flat surface such as a table, Depth is the measurement perpendicular to the Height, and is sometimes known as the width of a chain.

**Figure 4-37 Chain**


#### 4.8.6.2.5 Necklaces

The Default Front is as unclasped and laid out on a flat surface such as a table. The Width is the effective length of the chain, clasp to clasp. The Height is the top to bottom measurement when laid out on a flat surface; Depth is the measurement perpendicular to the Height.

#### 4.8.6.2.6 Pendants

Default Front is the front of the pendant as it would be worn. Height is from the bottom of the pendant to the top of the bale (that "circle" the chain threads through). Width is the effective length of the chain; Depth is from the front to the back of the pendant.

#### 4.8.6.2.7 Pins

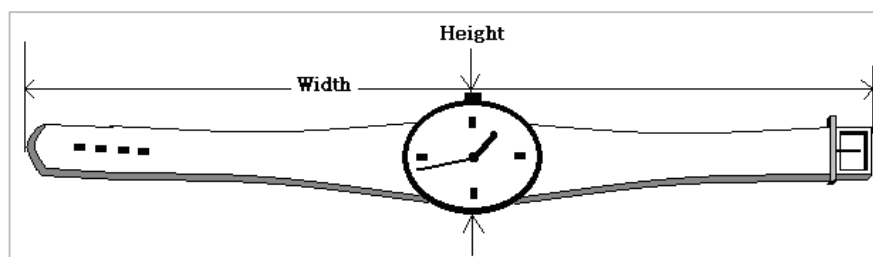
The Default Front is the opposite surface from the fastener pin while the fastener pin is in the horizontal orientation. Height is the top to bottom measurement, Width is the left to right measurement and Depth is the front to back measurement.

#### 4.8.6.2.8 Charms/slides without chain

Default Front is the front of the charm as it would be worn. Height is from the bottom of the charm to the top of the bale. Width is the left to right measurement; Depth is from the front to the back of the charm.

#### 4.8.6.2.9 Strap style watches with 2 piece strap that needs to be buckled to wear

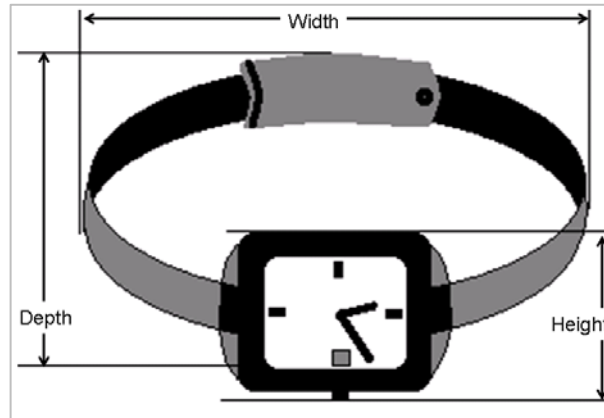
Default front is the face of the watch. Width is the full length from the end of the buckle/clasp to the end of the other strap. Height is from the bottom to the top (possibly from the crown to the other side), and Depth is from the front to the back.

**Figure 4-38 Strap style watch**


#### 4.8.6.2.10 Bracelet style watches with one piece bracelets, measured clasped

Default front is the face of the watch. Height is from the bottom of the watch to the top, Width is the outer diameter of the bracelet while facing the Default Front. Depth is from the front-most point of the Default Front to the rear-most point of the watch.

**Figure 4-39** Bracelet style watch



**4.8.6.2.11 Pocket style watches**

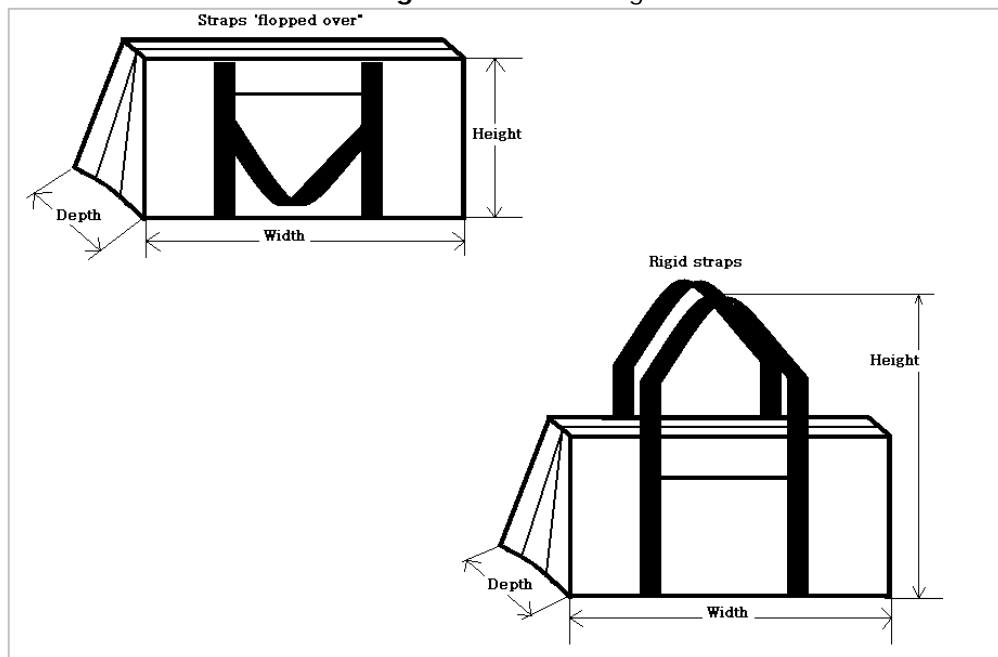
The Default Front is the face of the watch oriented with the 12 o'clock position "up". Measurements will include any fob or chain. Height is from the bottom most point to the top most point while facing the Default Front, Width is the left to right measurement and Depth is from the front most point to the rear most point.

**4.8.7 Accessory items**

**4.8.7.1 Handbags**

Handbags are measured in their Natural State and includes being stuffed. All straps/handles should be allowed to fall naturally, and any detachable strap will be assumed to be inside the bag. The Default Front is the largest surface oriented to be facing it as if for use, that is, on a flat surface such as a table sitting on its base- that surface opposite from the opening.. Height is from the bottom to the top, Width is the left to right measurement and the Depth is from the front to the back.

**Figure 4-40** Handbag



#### 4.8.7.2 Wallets

This category includes check book covers, passport cases, cigarette cases, lipstick cases, change purses, glasses cases, business card holders etc. Items in this category are measured closed or folded for use. The attached chain of a trucker/biker wallet is not measured.

This category item is oriented facing the longest surface in the left to right position, which is the Default Front. The Height is the top to bottom measurement, Width is the left to right measurement, and the Depth is the front to back measurement or thickness.

#### 4.8.7.3 Belts

Belts are measured as if hanging from the buckle end. Height is from the top of the buckle or the top of the hang tag to the tip of the other end of the belt, Width is left to right measurement and Depth is the measurement of the thickest point of the belt.

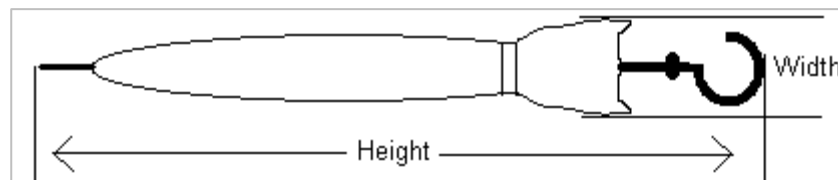
#### 4.8.7.4 Sunglasses/Reading glasses

These items are never shipped loose, but in poly bags, and are therefore in a Defined State. The Default Front is the largest, highest surface; facing the Default Front, Height is from the top to the bottom, Width is the left to right measurement and Depth is the front to back measurement.

#### 4.8.7.5 Umbrellas

Umbrellas are measured closed, compressed and clasped. The largest (widest), tallest surface is the Default Front oriented with the handle end in the 12 o'clock position. Height is from the end of the handle to the tip of the other end, Width is the left to right measurement and Depth is the front to back measurement.

Figure 4-41 Umbrella



#### 4.8.7.6 Key chains, small leather

If in a Defined State, the Package Measurement Rules prevail. If in a Natural State then measure as if hanging. While facing the Default Front, Height is from the top of the large ring to the bottom most point, Width is the left to right measurement and Depth is the front to back measurement.

#### 4.8.7.7 Pill boxes

If in a Natural State, the largest surface and the tallest orientation is the Default Front. While facing the Default Front, Height is from the bottom to the top, Width is the left to right measurement and Depth is the front to back measurement.

#### 4.8.7.8 Music player cases/Cell phone cases

In the Natural State, the Default Front is facing the surface meant to show the display screen. The top is the opening side. Height is from the top to the bottom, Width is the left to right measurement and Depth is the front to back measurement.

#### 4.8.7.9 Hair accessories

Any hanger tabs or packaging will designate a Defined State, and the item is to be measured according to the Package Measurement Rules. Open ended headbands are oriented with the open end down. In the Natural State, the largest, tallest panel will be the Default Front. Height is from the bottom most point to the topmost point, Width is the largest left to right measurement, Depth is from front to the back.

#### 4.8.8 Kitchen items

##### 4.8.8.1 Measuring cups/Spoons

Place on a flat surface such as a table, oriented as for use, facing the widest panel as the Default Front. Height is from the bottom to the top, Width is from the left-most point to the right most point. Depth is from the Default Front to the back-most point. Measuring spoons that are designed to hang should be measured as if hanging.

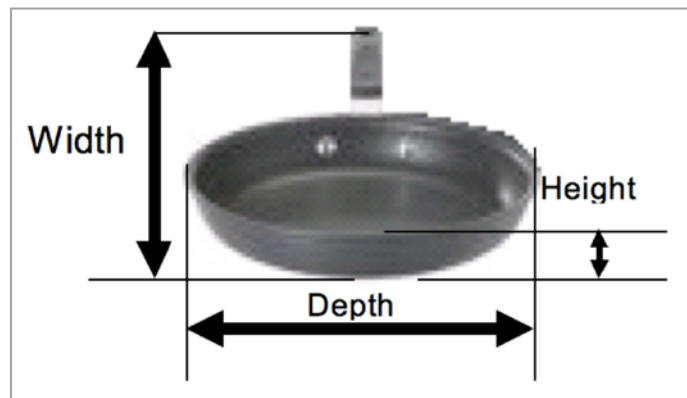
##### 4.8.8.2 Hanging basket/Hanging pot rack

Measure while hanging facing the widest (left to right) panel as the Default Front. Height is from the bottom-most point (on hanging Pot Rack this is possibly from the bottom of the hooks) to the top of the hanger(s). Width is the left to right measurement; Depth is from the Default Front to the back-most point.

##### 4.8.8.3 Pots and pans

Place on a flat surface, such as a table, oriented for use, facing the widest panel as the Default Front. Height is from the base to the top. Width is from the left-most point to the right-most point; Depth is from the Default Front to the back-most point. If the item has a lid, measure with the lid in place.

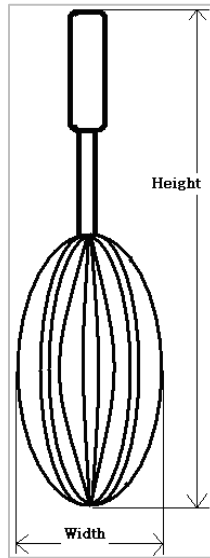
Figure 4-42 Pan



##### 4.8.8.4 Kitchen utensils/Flatware

If the item has a hanger hole, measure as if hanging, facing it as the Default Front. Height is the bottom-most point to the top-most point, Width is the left to right measurement, and Depth is from the front-most point to the back-most point. If the item does not have a hanger hole, place on a flat surface, such as a table, with the handle oriented to 12 o'clock, facing the item as the Default Front.

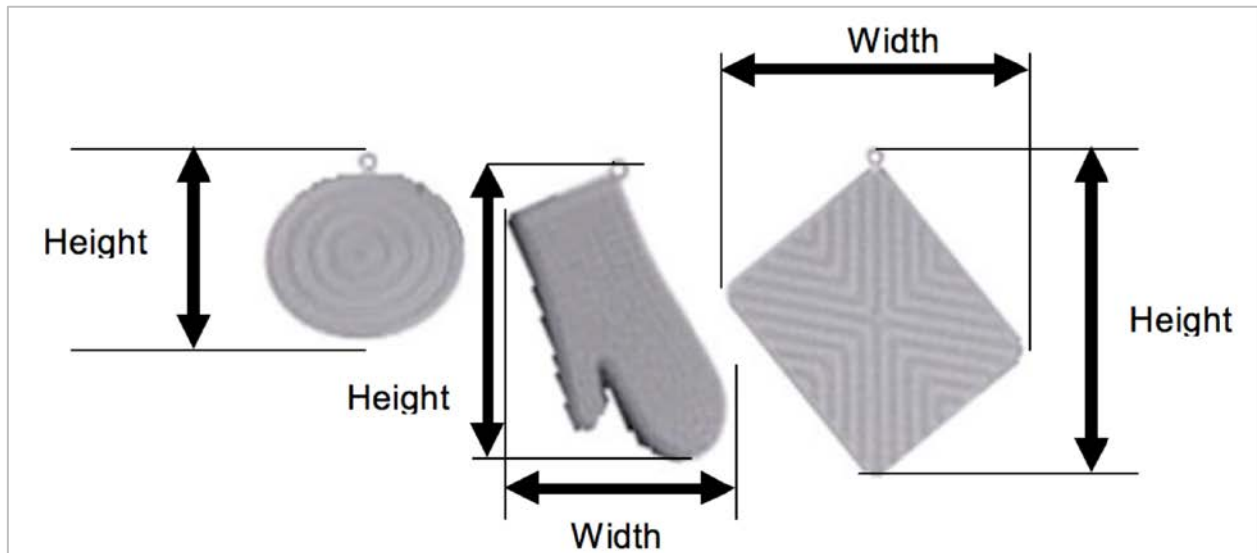
**Figure 4-43** Kitchen utensils/flatware



**4.8.8.5 Pot holders/Gloves**

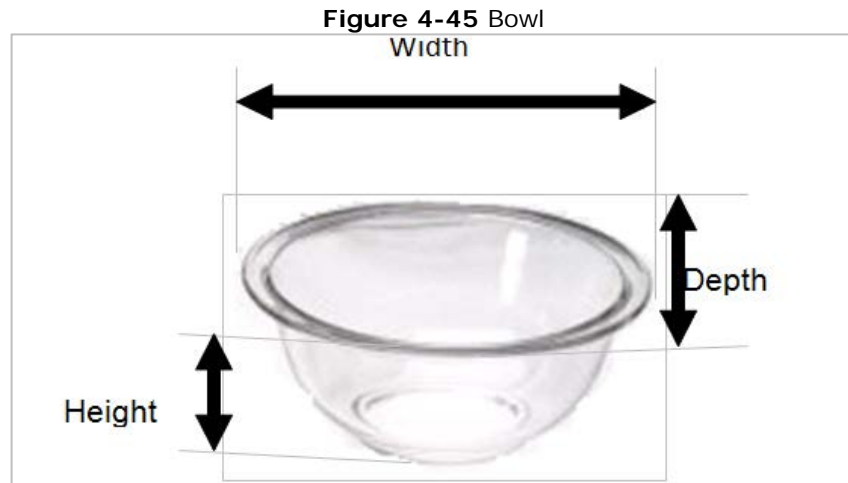
If the item has a hanger hole, measure as if hanging, facing it as the Default Front. Height is from the bottom-most point to the top-most point, Width is the left to right measurement, and Depth is from the front-most point to the back-most point. If it does not have a hanger hole, place on a flat surface, such as a table, with the longest surface in the left to right orientation (as the Width) facing it as the Default Front.

**Figure 4-44** Pot holders/gloves



**4.8.8.6 Dinnerware (bowls, cups, saucers, plates, mugs, stemware), mixing bowls, mortar and pestle**

Place on a flat surface, such as a table, oriented for use, facing the widest panel as the Default Front. Height is from the base to the top-most point, Width is the left-most point to the right-most point, and Depth is from the Default Front to the back-most point.

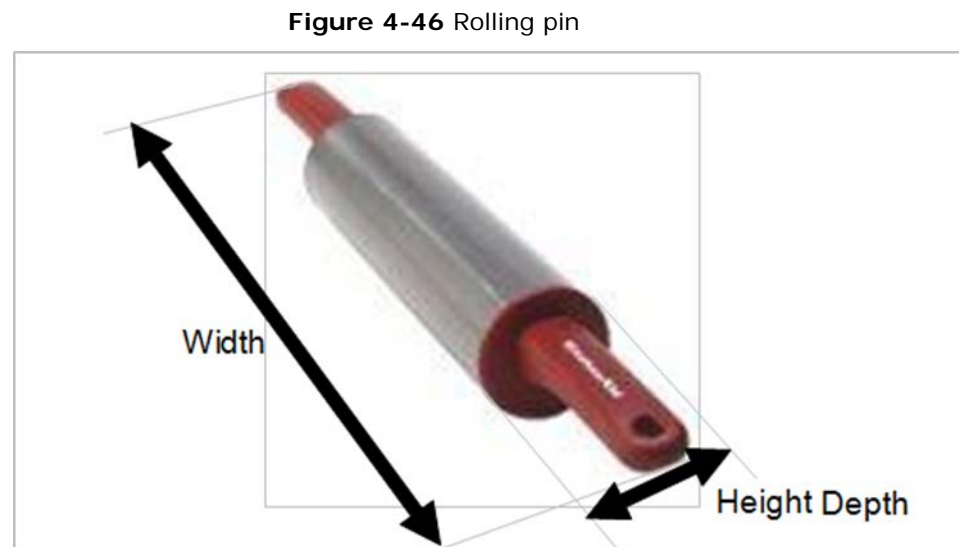


#### 4.8.8.7 Drawer inserts/Cookie sheets/Cutting boards/Racks

Place on a flat surface, such as a table, oriented for use, facing the widest panel as the Default Front. Height is from the bottom to the top, Width is the left-most point to the right-most point, and Depth is from the Default Front to the back.

#### 4.8.8.8 Rolling pin

Place on a flat surface, such as a table, oriented for use, facing the widest panel as the Default Front. Height is from the bottom to the top, Width is the left-most point to the right-most point, and Depth is from the Default Front to the back-most point.



#### 4.8.8.9 Spice rack

Place on a flat surface, such as a table, oriented for use, facing the widest panel as the Default Front. Height is from the bottom to the top, Width is the left-most point to the right-most point, and Depth is from the Default Front to the back-most point.

#### 4.8.8.10 Dish/Cooling rack

Place on a flat surface, such as a table, oriented for use, facing the widest panel as the Default Front. Height is from the bottom to the top, Width is the left-most point to the right-most point, and Depth is from the Default Front to the back-most point.

**4.8.8.11 Trash can/Basket**

Place on a flat surface, such as a table, oriented for use, facing the widest panel as the Default Front. Height is from the bottom to the top, Width is the left-most point to the right-most point, and Depth is from the Default Front to the back-most point.

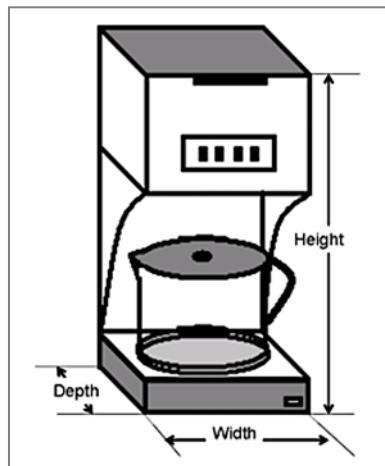
**4.8.8.12 Cake pedestal**

Place on a flat surface, such as a table, oriented for use, facing the widest panel as the Default Front. Height is from the bottom to the top, Width is the left-most point to the right-most point, and Depth is from the Default Front to the back-most point. Measure with lid in place.

**4.8.8.13 Small kitchen appliances**

Place on a flat surface, such as a table, oriented for use, facing the widest panel as the Default Front. Height is from the bottom to the top, Width is the left-most point to the right-most point, and Depth is from the Default Front to the back-most point.

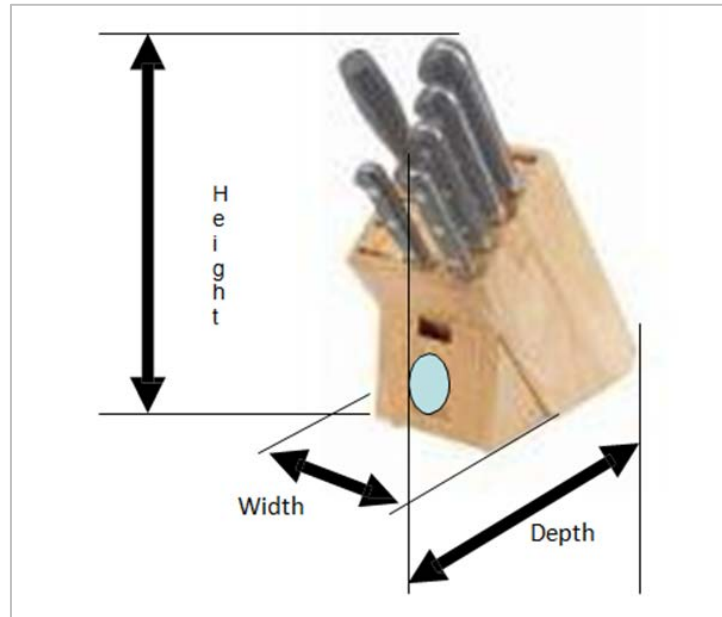
**Figure 4-47** Small kitchen appliance



**4.8.8.14 Knife block**

Place on a flat surface, such as a table, oriented for use, facing the knife handles as the Default Front. Height is from the bottom to the top, Width is the left-most point to the right-most point, and Depth is from the Default Front to the back-most point.

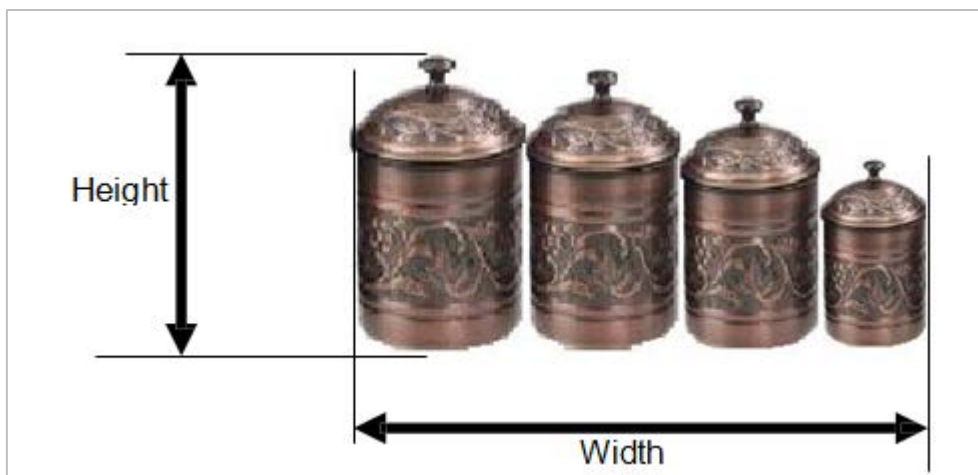
**Figure 4-48 Knives**



**4.8.8.15 Canisters/Cookie jars**

If in a set, place on a flat surface, such as a table, oriented for use, side by side, up against one another, facing them as the Default Front. Height is the top to bottom measurement of the largest canister, Width is the measurement from the left-most point to the right-most point of the canisters side by side, and Depth is the largest front to back measurement. If separate item, place on a flat surface, such as a table, oriented for use, facing the largest left to right dimension as the Default Front, measure Height as top to bottom, Width is left to right and Depth is the front to back measurement.

**Figure 4-49 Canisters/cookie jars**



**4.8.9 Sporting good items**

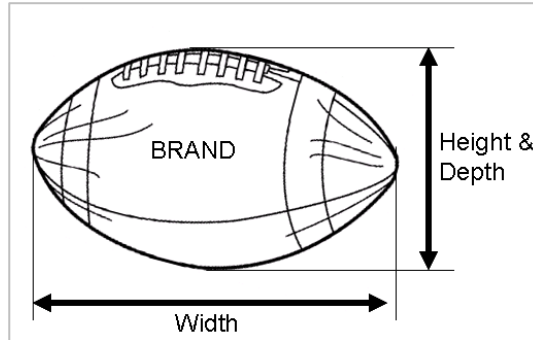
**4.8.9.1 Round balls**

Round balls are equal in Height, Width and Depth when inflated- in a Defined State. When in the Natural State (un-inflated), face the largest panel as the Default Front- the largest dimension is the Width, Height is from the bottom to the top of the Default Front and Depth is from the front-most point to the rear-most point.

#### 4.8.9.2 Elliptical balls

Default Front faces the laces with the longest dimension as the Width, Height and Depth are equal. Balls that are un-inflated are in their Natural State, those that are inflated are in their Defined State.

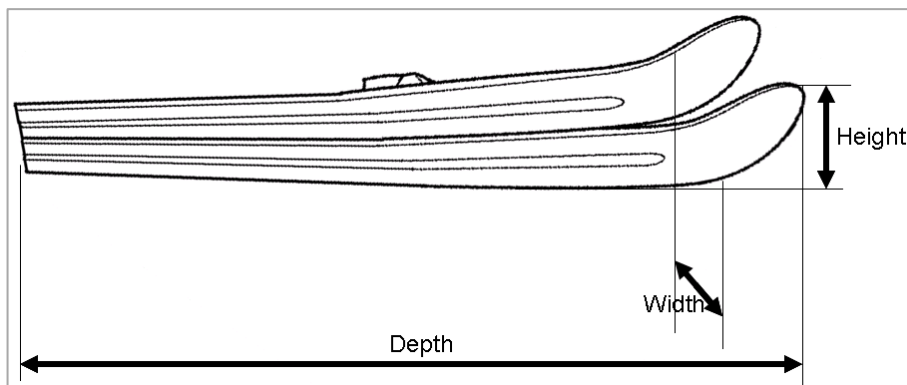
Figure 4-50 Elliptical ball



#### 4.8.9.3 Skis

Are measured similar to shoes on a flat surface, the Default Front is facing the toe with both skis touching side by side. The Height is from the flat surface to the top-most point, Width is the largest left to right measurement, Depth is from the front-most point to the rear most point. Single skis (e.g., water ski) snowboards, sleds, skateboards etc. are measured in a similar way. Skateboard measurement is made in this manner whether the board has wheels or not.

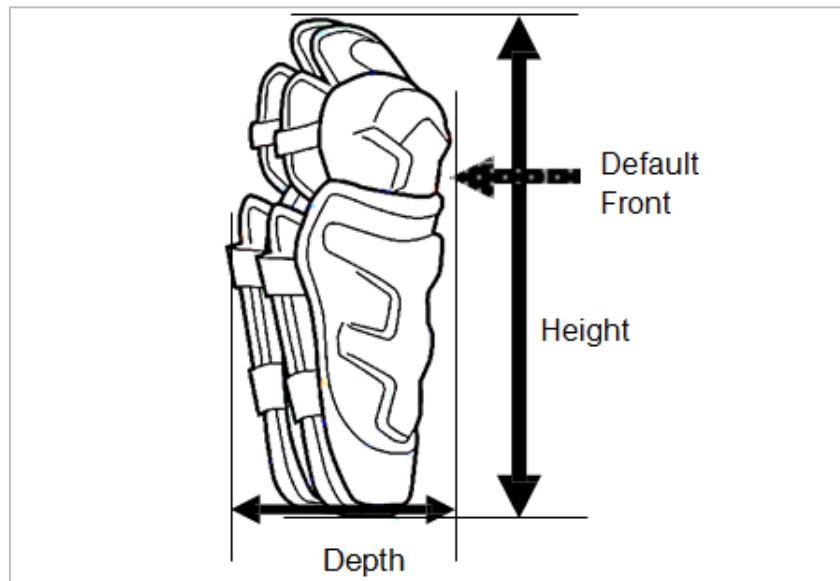
Figure 4-51 Skis



#### 4.8.9.4 Nest-able protective equipment (e.g., pair of shin guards)

Nested and laid on a flat surface, such as a table, the Default Front and orientation corresponds to facing how a person would wear the item. Height is the top to bottom measurement, Width is the left to right measurement; Depth is from the Default Front to the flat surface.

**Figure 4-52** Protective equipment



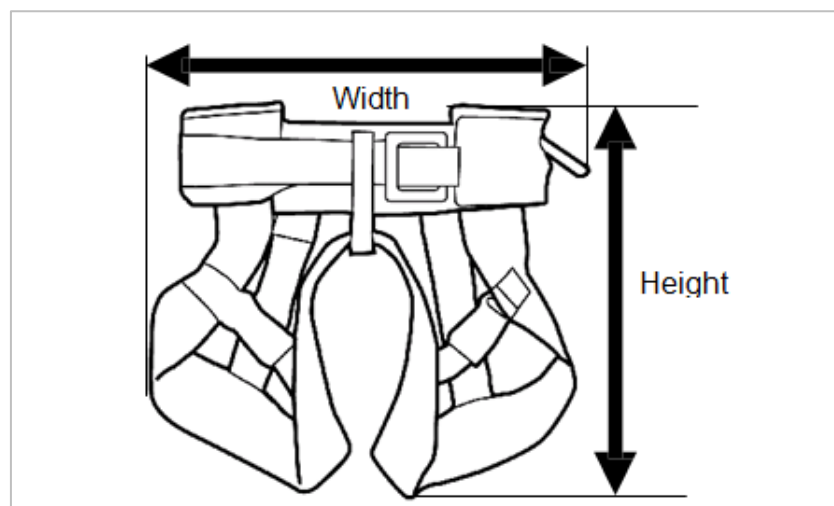
**4.8.9.5 Water bottle/Thermos/Camp stove/gas bottle**

Sitting on its base for use, the Default Front is facing the widest orientation. Height is from the base to the top-most point; Width is the left to right measurement while facing the Default Front, Depth is from the Default Front to the rear-most point.

**4.8.9.6 Gear meant to be worn**

Gear is laid on a flat surface, such as a table, all straps adjusted to their shortest length; Default Front corresponds to the front of a person. Height is the top to bottom measurement, Width is the left to right measurement, Depth is the thickness.

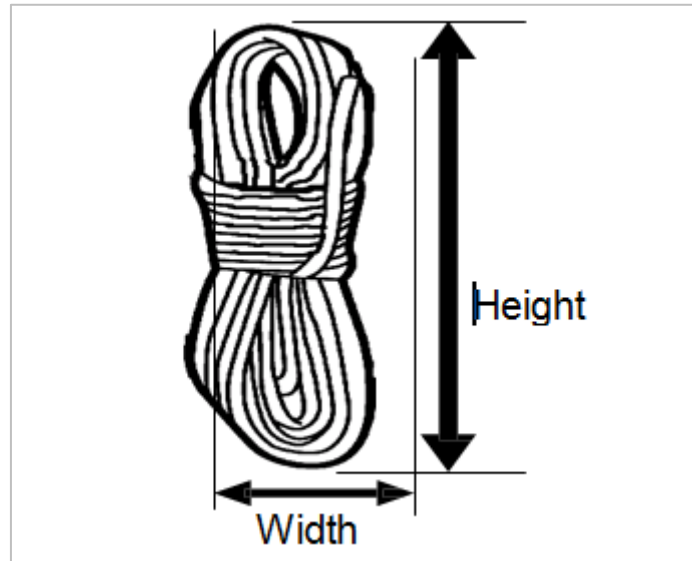
**Figure 4-53** Gear



**4.8.9.7 Self-bundled rope**

Measured as if looped and hanging, Height from the top-most point to the bottom, Width is the left to right measurement; Depth is from the front to the back.

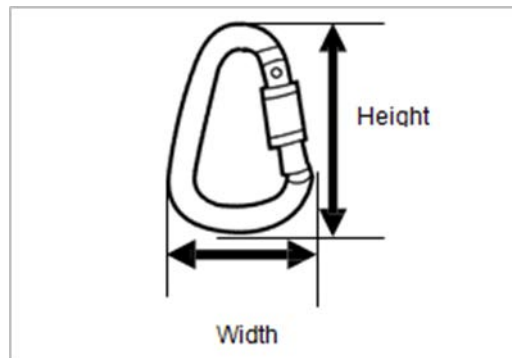
**Figure 4-54** Self-bundled rope



**4.8.9.8 Karabiner**

Measured as if hanging, Height is from the top to the bottom, Width is the left to right measurement, and Depth is the thickness of the item.

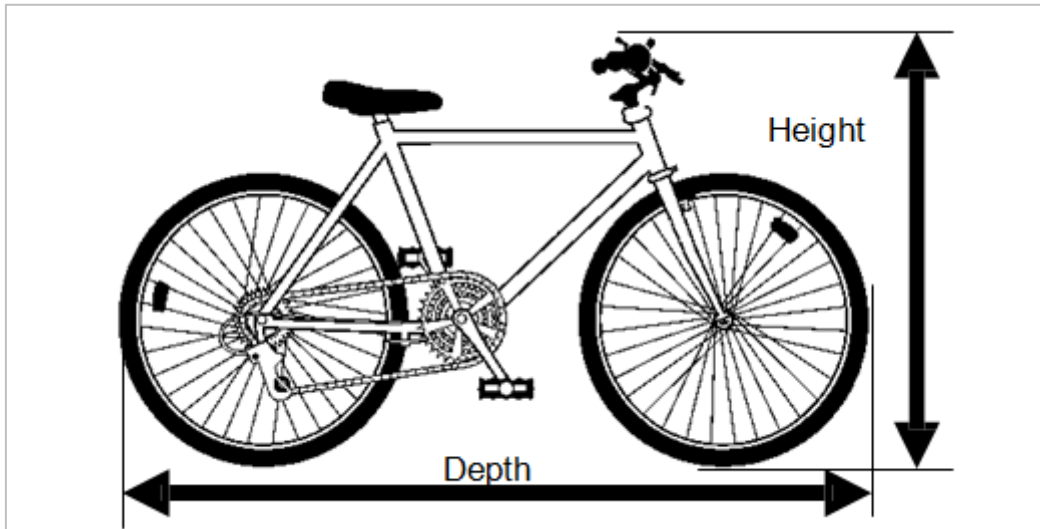
**Figure 4-55** Karabiner



**4.8.9.9 Bicycle**

Measured while facing the front of the bicycle, upright on a flat surface (not leaning on its kickstand), with the seat and handle bars at the lowest adjustment. Height is from the highest point to the flat surface, Width is the left to right measurement at the widest point (e.g., handle bars or pedals), and Depth is from the front-most point to the rear-most point.

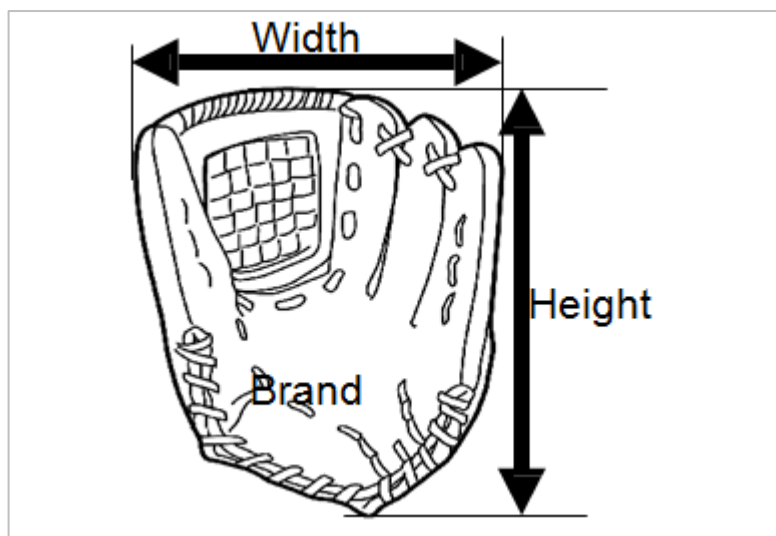
**Figure 4-56** Bicycle



**4.8.9.10 Baseball/Softball glove**

Oriented on a flat surface, such as a table, facing the “pocket” of the glove with the fingers straight up. Height is from the top-most point to the bottom-most point, Width is the largest left to right measurement, and Depth is from the front-most point to the flat surface.

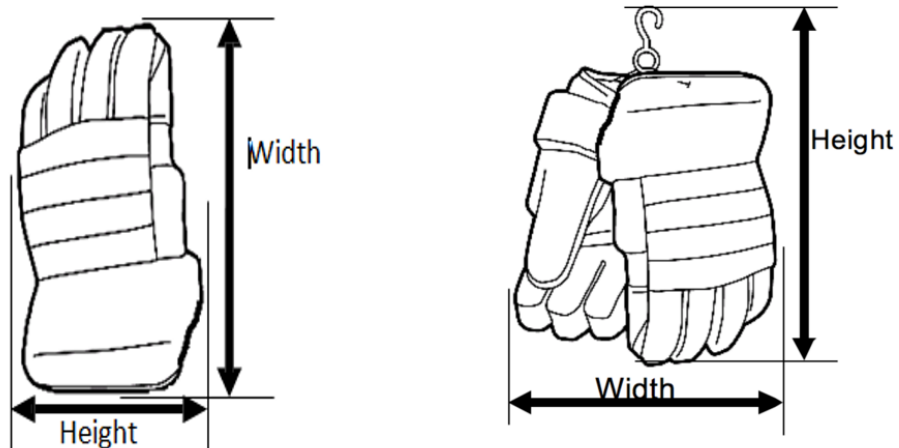
**Figure 4-57** Baseball//softball glove



**4.8.9.11 Hockey/Lacrosse gloves- pair**

If attached with a hanger, measure as if hanging, Height is from the top of the hanger to the bottom most point, Width is the largest left to right measurement, Depth is from the front to the back. If loose, measure similar to the baseball glove, palm to palm stacked, on a flat surface, such as a table, fingers pointing to 12 o'clock. Height from bottom to the top, Width is the left to right measurement; Depth is from the front to the flat surface.

**Figure 4-58** Hockey/lacrosse gloves (pair)

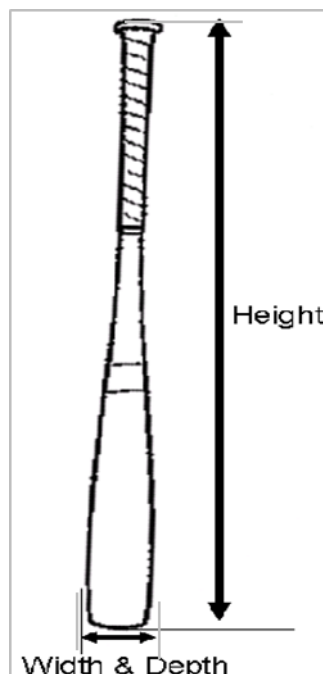


**4.8.9.12 Baseball, cricket etc. bat, canoe paddle, golf club, hockey stick, tennis-**

**Racquetball-squash racket**

Orient handle end to 12 o'clock on a flat surface, such as a table, Height is from the bottom to the top, Width is the largest left to right measurement, and Depth is from the front to the flat surface.

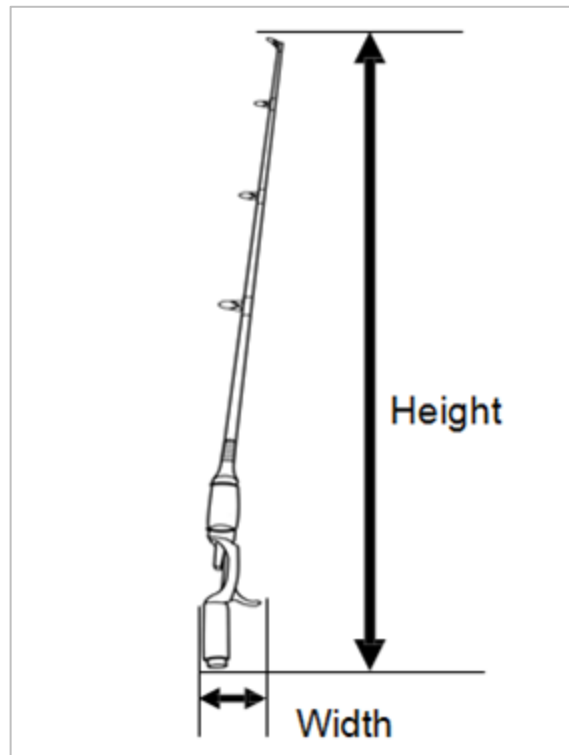
**Figure 4-59** Baseball bat



**4.8.9.13 Fishing rod**

Orient handle end to 6 o'clock on a flat surface, such as a table facing the widest panel. Height is from the bottom to the top, Width is the largest left to right measurement, and Depth is from the front to the flat surface.

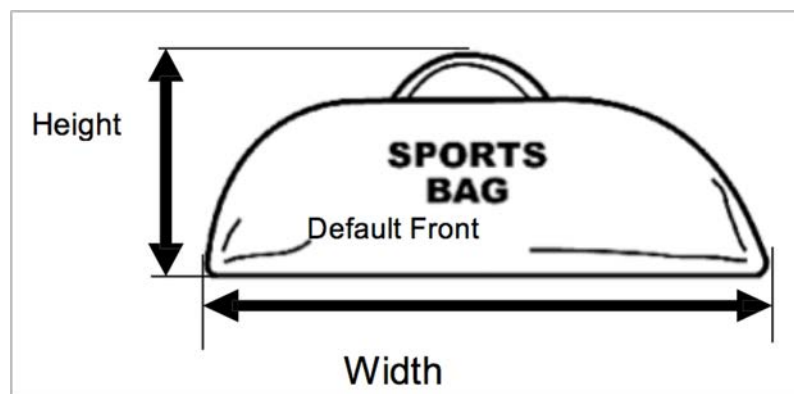
**Figure 4-60** Fishing rod



**4.8.9.14 Sports bag, duffle**

Orient base onto flat surface facing the longest side, the bag is not collapsed, but assumed to be stuffed. Height is from the base to the top-most point, Width is the largest left to right measurement, Depth is the front to back measurement.

**Figure 4-61** Sports bag



**4.8.9.15 Backpacks**

Orient top to 12 o'clock onto flat surface, such as a table, facing the surface opposite the one touching the back as Default Front.

Height is from the base to the top-most point, Width is the largest left to right measurement, and Depth is the front to back measurement. The pack is not collapsed, but assumed to be stuffed.

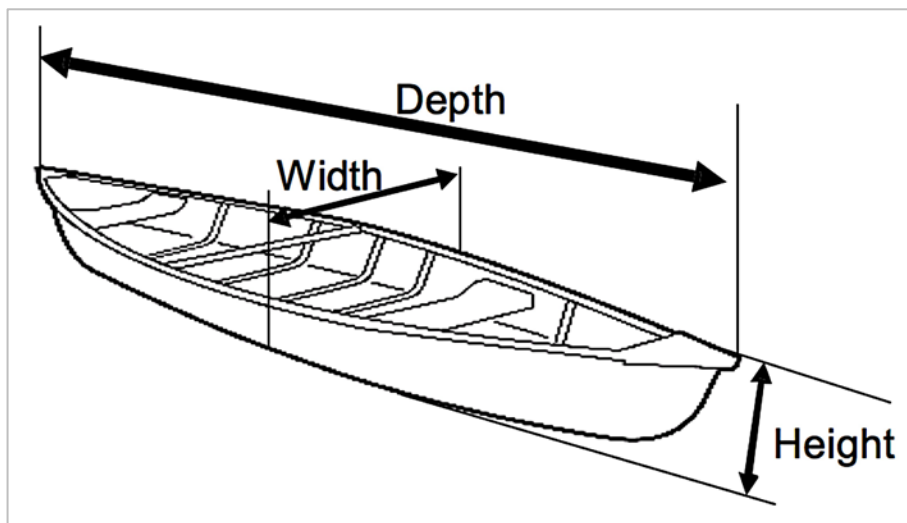
**Figure 4-62 Backpack**



**4.8.9.16 Canoe, boat, other vehicle**

The Default Front is facing the front of the vehicle (upright, not leaning). Height is from the lowest point to the highest point while facing the Default Front, Width is the largest left to right measurement while facing the Default Front; Depth is from the front-most point to the rear-most point while facing the Default Front.

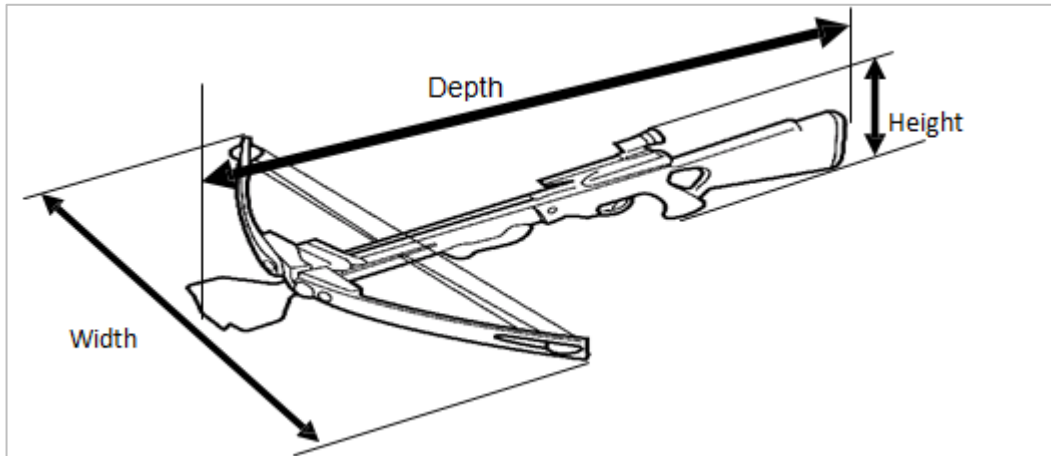
**Figure 4-63 Canoe**



**4.8.9.17 Crossbow**

Default Front is facing the front of the crossbow while sitting upright on a flat surface, such as a table. Height is from the flat surface to the top-most point, Width is the largest left to right measurement, and Depth is from the front-most point to the rear-most point.

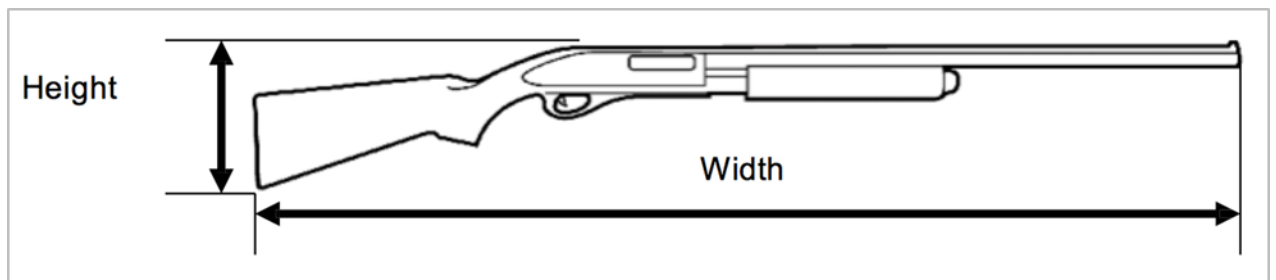
**Figure 4-64** Crossbow



**4.8.9.18 Rifle, long gun ---**

Orient the item on a flat surface, such as a table, with the barrel horizontal. Height is from the top-most point to the bottom-most point, Width is from the left-most point to the right-most point (end of the stock to the end of the barrel) and Depth is from the front-most point to the flat surface.

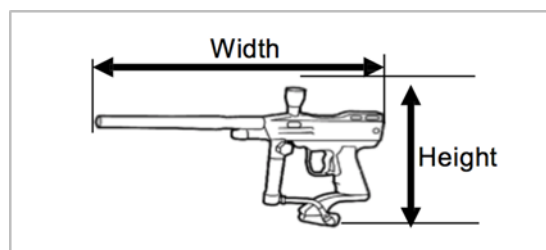
**Figure 4-65** Rifle



**4.8.9.19 Hand gun/Paintball gun**

Orient the item on a flat surface, such as a table, with the barrel horizontal. Height is from the top-most point to the bottom-most point, Width is the largest left to right measurement, and Depth is from the front to the flat surface.

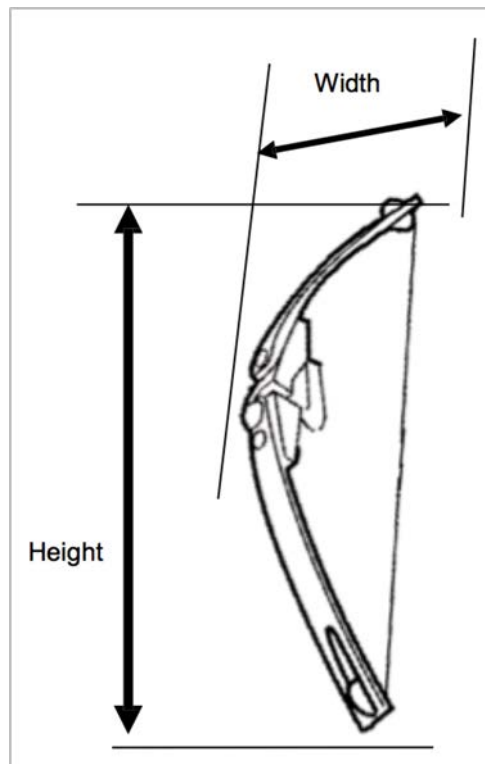
**Figure 4-66** Paintball gun



**4.8.9.20 Long, compound bow**

Orient item onto a flat surface, such as a table, if strung, position the bowstring from 12 o'clock to 6 o'clock, if unstrung position the end of the bow to the 12 o'clock position. Height is from the top-most point to the bottom-most point, Width is the largest left to right measurement and Depth is from the front to the flat surface.

**Figure 4-67** Long, compound bow



## 4.9 Product specific (nursery stock and building materials) measurements

### 4.9.1 Overview

This section covers the measurement of trade items in the following categories: Nursery Stock and their containers, and Building Products.

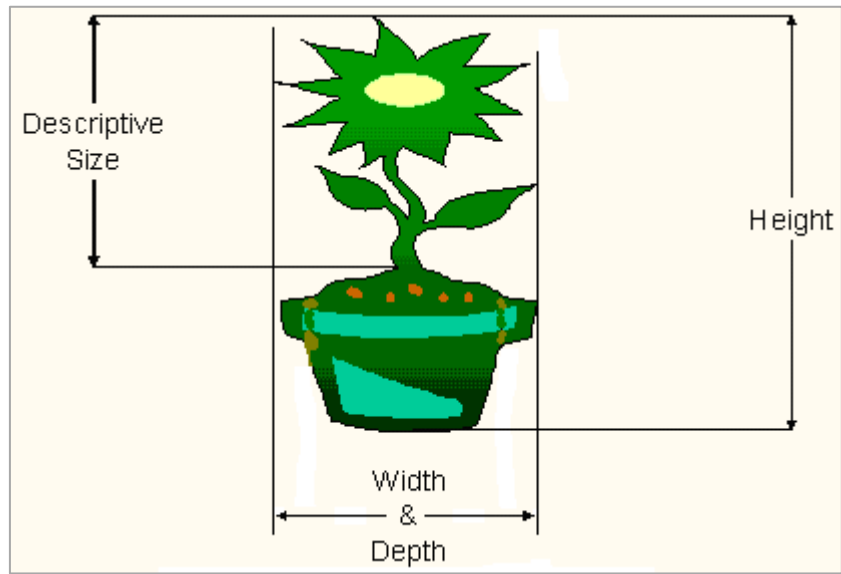
### 4.9.2 Nursery stock, and their containers

A plant in a pot or a tree in a container or balled & wrapped in burlap (B&B) or a cut tree is considered a packaged consumer trade item. The values for the consumer trade item measurements of Height, Width, and Depth are as presented in the figures below. The Default Front is determined by orienting the item for use as seen in [Figure 4-68](#), with the base of the tree, pot, container or plant "ball" on a flat surface such as a table, facing the largest left to right surface and the plant itself up, generally as it is growing, to the 12 o'clock position.

All measurements are taken while facing the Default Front.

- Height is from the flat surface to the top-most point of the plant. Height is nominal height.
- Width is the largest left to right measurement. This could be the diameter of the pot, container or ball if the plant does not spread beyond the pot, container or ball. If the plant does spread beyond, Width is that nominal spread.
- Depth is the measurement from the Default Front to the rear -most point. This could be the diameter of the pot, container or ball if the plant does not spread beyond the pot, container or ball. If the plant does spread beyond, Depth is that nominal spread.

**Figure 4-68** Nursery stock



**Figure 4-69** Nursery stock

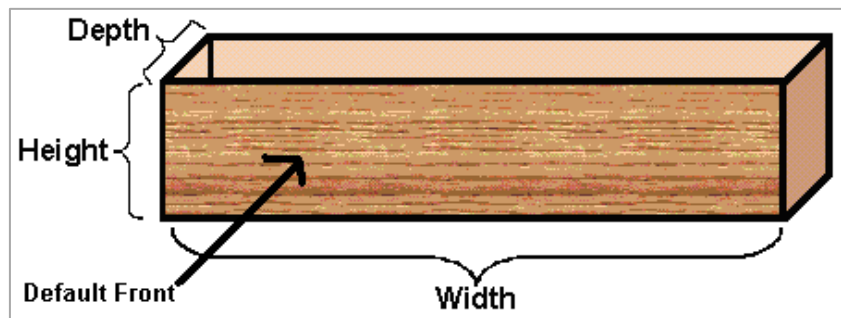


Figure 4-70 Cut trees

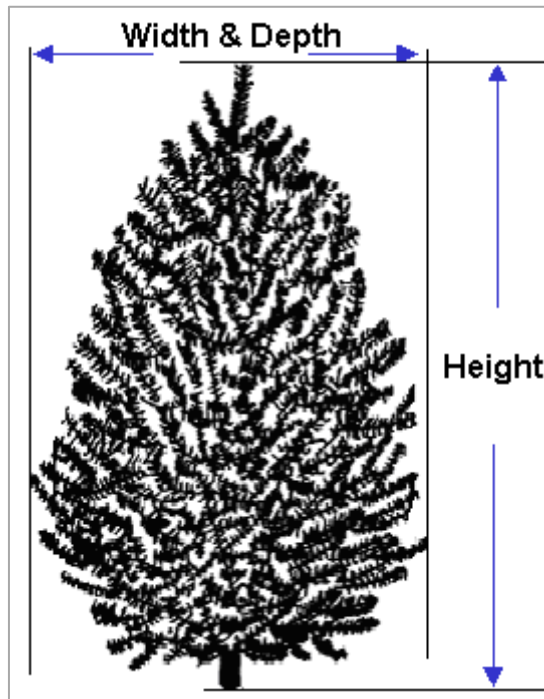
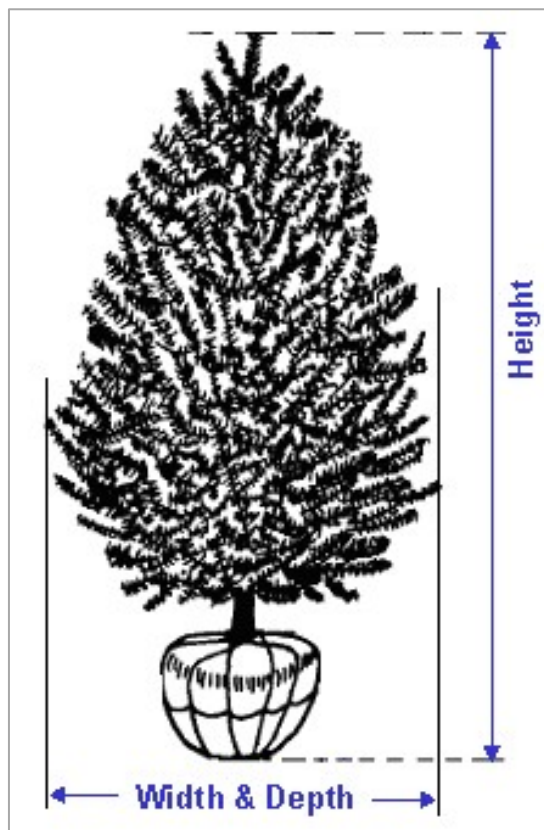


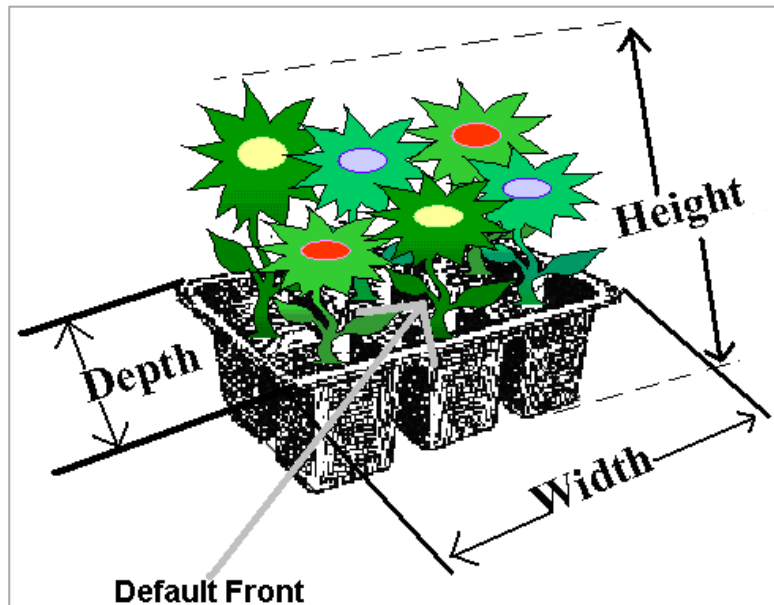
Figure 4-71 Other "live" goods



It is also recognised that live goods may have trade descriptions that are typically used for ordering purposes based on the height from the soil up. However, as implemented in this document, height is defined as the combined measurements of the plant height plus its container.

Smaller plants sold at retail are typically packaged for the consumer in, for example, four, six, or eight pack containers. This is the consumer unit and is marked with a GTIN. In this case there are seldom brands or marketing information markings, therefore, the largest surface is used as the Default Front and measurements are taken from that reference surface.

**Figure 4-72** Small plant in 6-pack container



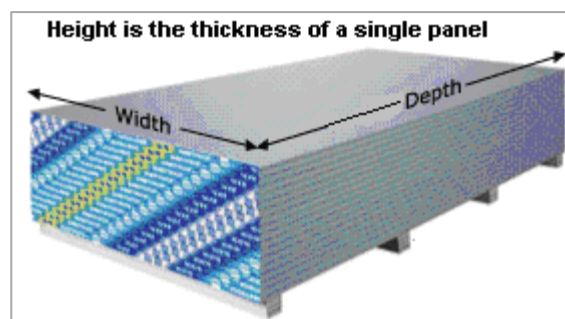
### 4.9.3 Building products

This section covers products, which are typically associated with building construction, and covers only consumer trade items.

#### 4.9.3.1 Panelised products

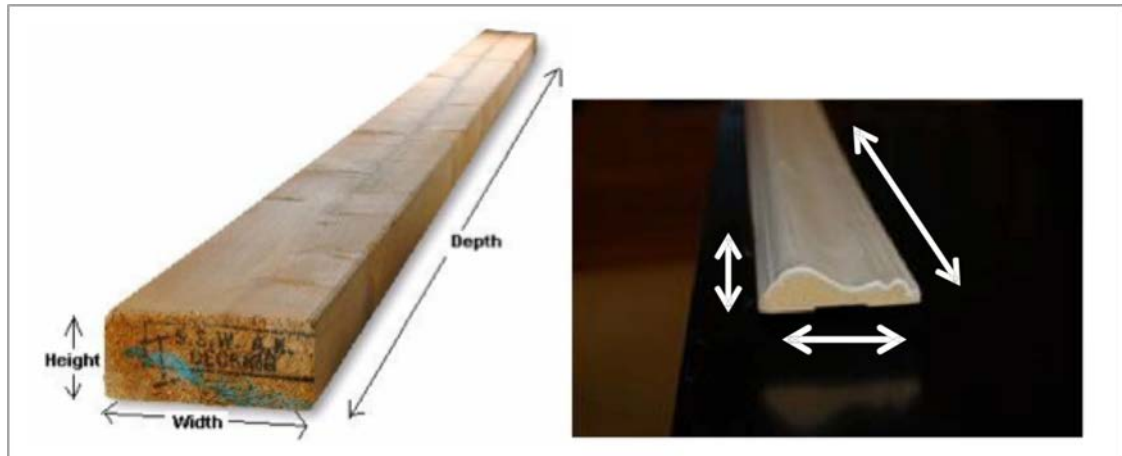
Measurements are determined as described below without respect to markings. Typical products include drywall, plywood, sheathing, and panelling. Height is the shortest dimension, Width is the next longest dimension, and Depth is the longest dimension

**Figure 4-73** Panel product measurements



#### 4.9.3.2 Dimensional lumber products, moulding, posts and columns

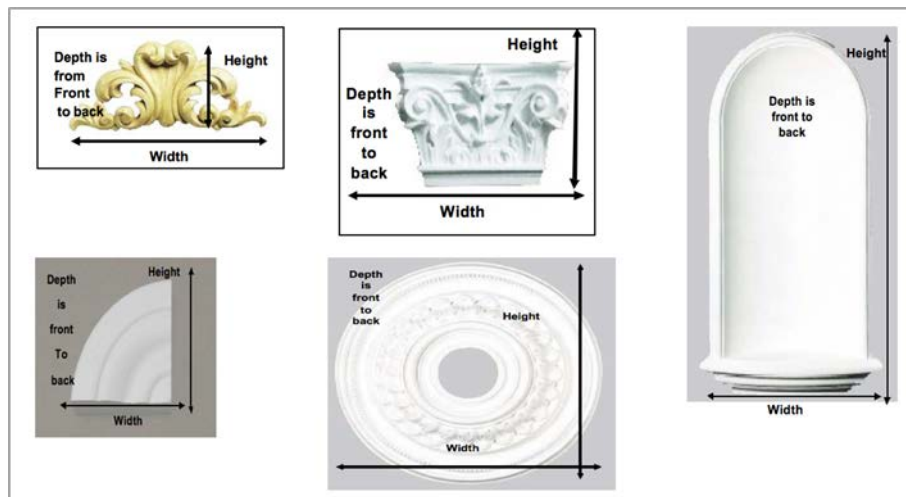
Measurements are determined as described below without respect to marking or packaging. Height is the shortest dimension, Width is the next longest dimension, and Depth is the longest dimension

**Figure 4-74** Dimensional lumber measurements


Frequently dimensional lumber products have commonly used descriptions that are not based on actual measurements, but on historical reference or trade descriptions, and their actual dimensions may be different. For example a 2 X 4 may actually measure 1½ inches by 3½ inches. **Always measure and synchronise actual dimensions rather than nominal dimensions.**

#### 4.9.3.3 Decorative moulding accessories

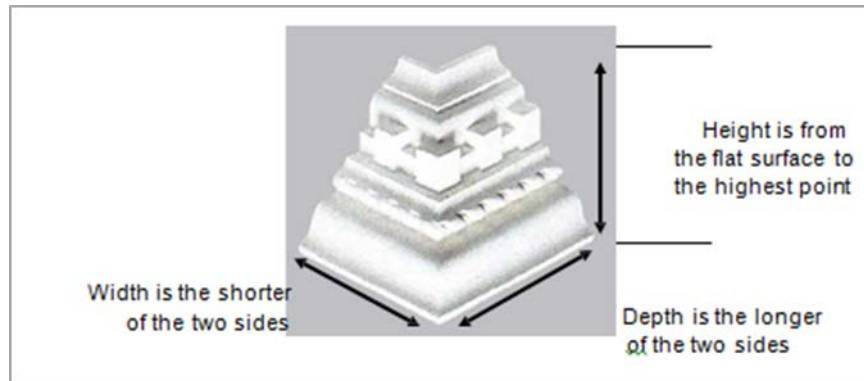
This section covers unpackaged decorative moulding accessories. Typical products include accents, capitols, corbels, medallions, niches, and rosettes. The Default Front is determined by orienting the item based on its use when installed. Width is from left most point to the right most point, Depth is from front the default front to the farthest opposite surface, and Height is from the bottom most point to the top most point.

**Figure 4-75** Decorative moulding accessories


#### 4.9.3.4 Pre-cut moulding miter blocks

This section covers unpackaged pre-cut moulding miter blocks that fit onto or into corners. Corner blocks are measured while sitting on a flat surface with the edges that would fit against the ceiling when installed resting on the flat surface. Width is the shorter of the two dimensions of the base, Depth is the longer of the two dimensions of the base, and Height is from the bottom most point to the topmost point

**Figure 4-76** Pre-cut moulding miter blocks



#### 4.9.3.5 Unpackaged stairway components

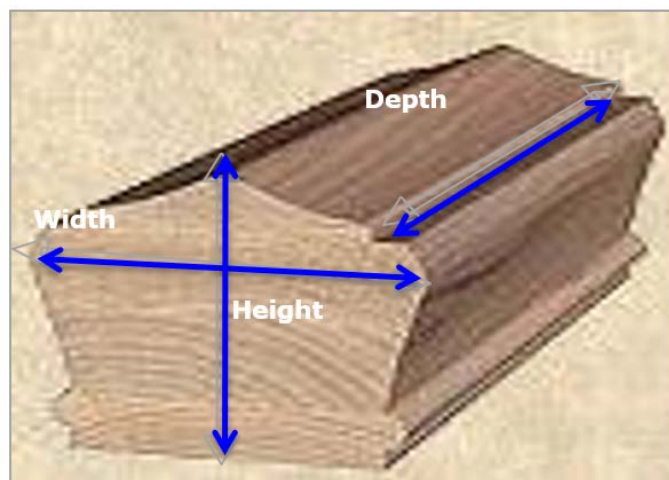
This section covers unpackaged components used in the construction of stairways. Due to the large variety of complex shapes and descriptions of these components, they are graphically illustrated for reference in Appendix A.

##### 4.9.3.5.1 Straight (collinear) stairway components

Components measured by this method include: handrails, wall rails, bending rail, shoe rail, fillets, balusters, newels, nose mouldings, starting steps, treads, risers, and skirt boards.

Measurements are determined as described below without respect to markings. Height is the shortest dimension, Width is the next longest dimension, and Depth is the longest dimension.

**Figure 4-77** Straight (collinear) stairway components



##### 4.9.3.5.2 Curved stairway components

These stairway components require a defined method of measurement based on their complex shapes.

The default front is determined by viewing the item straight on as installed while ascending the stairs. Components measured in this method include: caps, easings, goosenecks, volutes and turnouts.

**Figure 4-78** Curved stairway component measurement

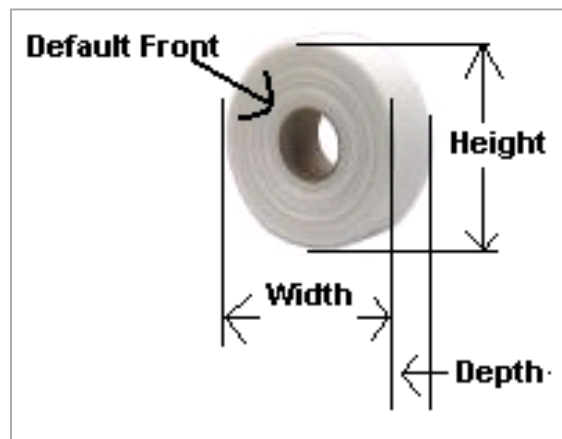


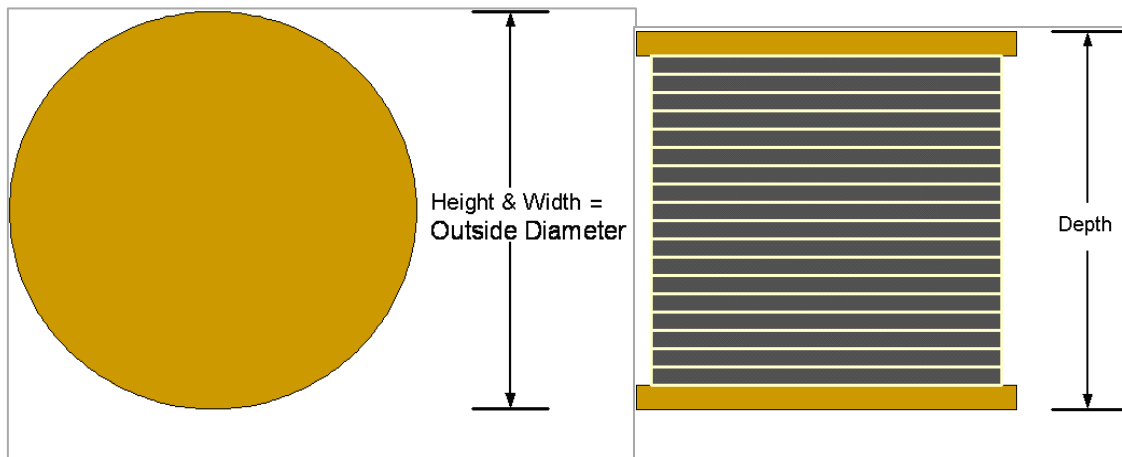
#### 4.9.3.6 Unpackaged roll products

For unpackaged roll products meant to pass POS, the *diameter* is identified as the Default Front. Examples include drywall tape, and spools of rope and wire.

- Height is the diameter of the roll
- Width is the diameter of the roll
- Depth is from the Default Front to the rear-most point

**Figure 4-79** Unpackaged roll product measurements



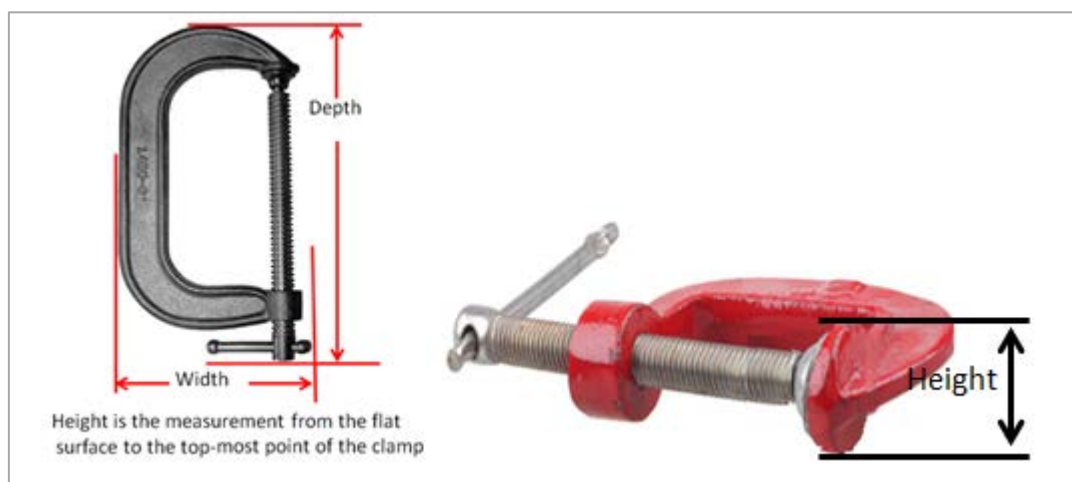
**Figure 4-80** Unpackaged roll product measurements


#### 4.9.4 Professional/Commercial tools and accessories

##### 4.9.4.1 Loose, unpackaged clamps

The Default Front of loose, unpackaged clamps is determined by laying the clamp on a flat surface, such as a table. The opening side will be oriented to the right, with the clamp in its most closed position, and the tension bar slid all the way in toward the clamp to provide for the narrowest width.

Height is measured from the flat surface to the top-most point of the clamp, Width is the measurement from the left-most point to the right-most point and Depth is the farthest point in the 6 o'clock position to the farthest point in the 12 o'clock position.

**Figure 4-81** Unpackaged hand tool measurements


##### 4.9.4.2 Hand tools

The Default Front of loose, unpackaged hand tools is determined by laying the hand tool on a flat surface, such as a table, oriented with the handle either in the six or twelve o'clock position.

Height is measured from the farthest point in the 6 o'clock position to the farthest point in the 12 o'clock position. Width is measured from the left most point to the right most point of the tool. Depth is measured from the flat surface to the furthest point from the flat surface.

Note that hand tools, which may be open (for instance, wire cutters, wrenches, callipers, etc.) are measured in their natural state or starting position, which is with the tool closed before use and before manual interaction.

**Figure 4-82** Hand tool measurements

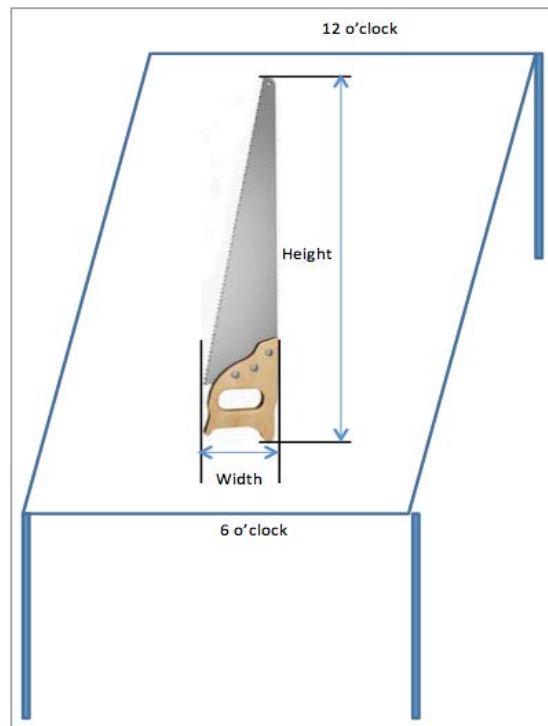


#### 4.9.4.3 Hand saws

The Default Front of loose, unpackaged hand saws is determined by laying the hand saw on a flat surface, such as a table, oriented with the straight edge of the blade parallel to the edge of the flat surface. Measurements are taken while facing the largest left to right surface of the saw.

Height is measured from the farthest point in the 6 o'clock position to the farthest point in the 12 o'clock position. Width is measured from the left most point to the right most point of the tool. Depth is measured from the flat surface to the furthest point from the flat surface.

**Figure 4-83** Hand saw measurements



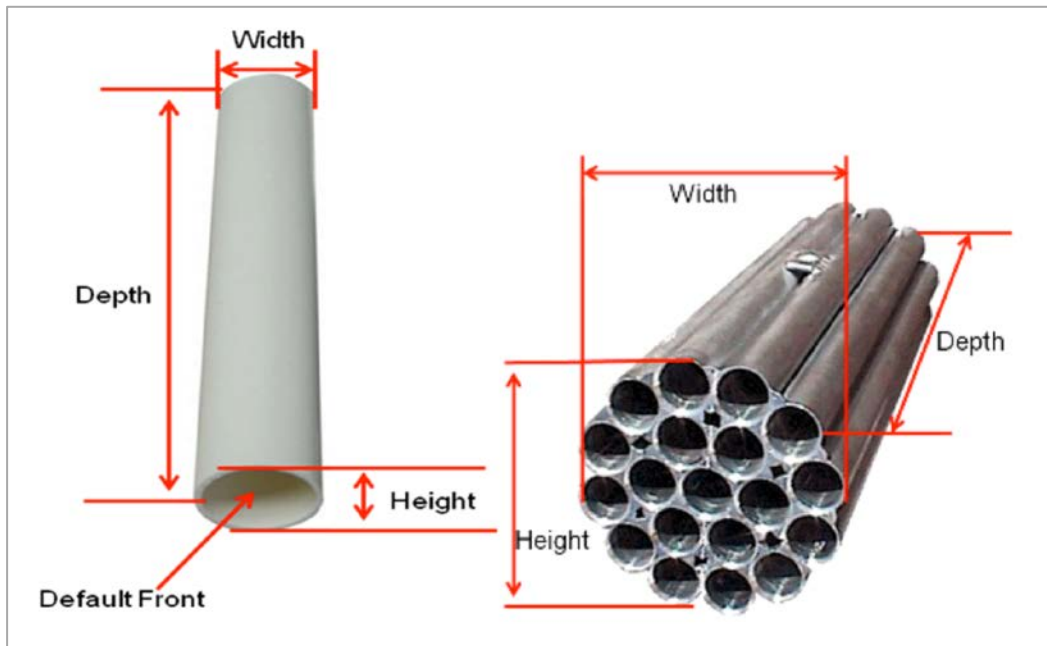
#### 4.9.5 Unpackaged plumbing parts

##### 4.9.5.1 Pipes

Measurements of unpackaged pipe are as described below. The open end is the Height and Width. For round pipe, the Height and Width are equal, for pipe that is not round, width defines the largest left to right dimension while facing the Default Front. The Depth dimension for the pipe is the

dimension most commonly referred to as the length of the pipe. Loose pipe bundled together as a single GTIN will be measured in the manner shown.

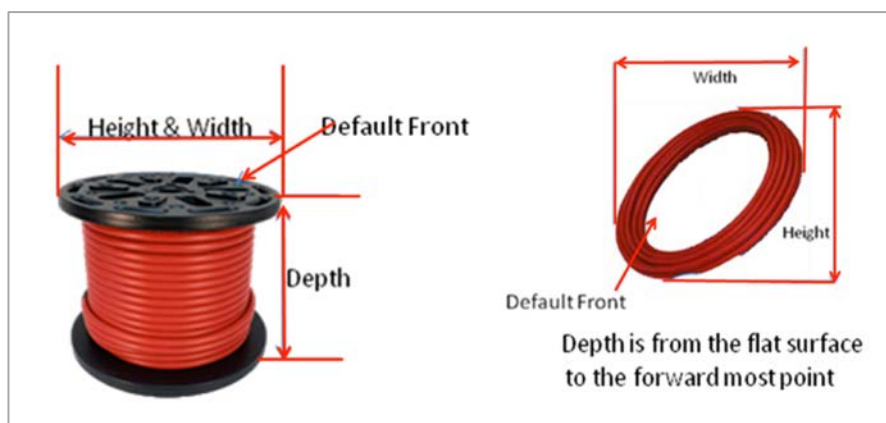
**Figure 4-84** Unpackaged pipe measurements.



#### 4.9.5.2 Coiled tubing

The Default Front of loose, unpackaged coiled tubing is identified as the diameter. Height and Width are the diameter of the coil; Depth is from the Default Front to the rear most point while sitting on a flat surface.

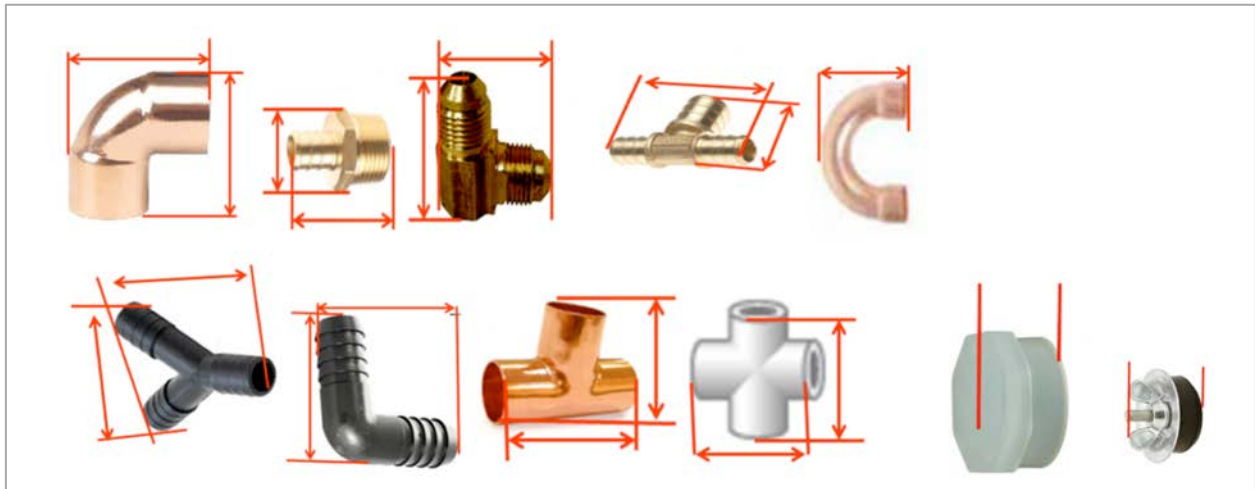
**Figure 4-85** Coiled tubing measurement.



#### 4.9.5.3 Pipe and tube fittings, manifolds miscellaneous parts

While sitting on a flat surface such as a table with at least one opening side facing 3 o'clock. The surface facing you is the Default Front. Measurements are taken left to right, 12 o'clock position to the 6 o'clock position and from the table surface to the outer most point of the Default Front. Measurements are: Longest = Depth, Next longest = Width, Shortest = Height

**Figure 4-86** Pipe/tube fittings, manifolds miscellaneous parts measurements.



#### 4.9.5.4 Drainage- traps, drains, wyes

These are positioned with the inlet, or one of the inlets in the 3 o'clock position. Measurements are taken left to right, 12 o'clock position to the 6 o'clock position and from the table surface to the outer most point of the Default Front. Measurements are: Longest = Depth, Next longest = Width, Shortest = Height

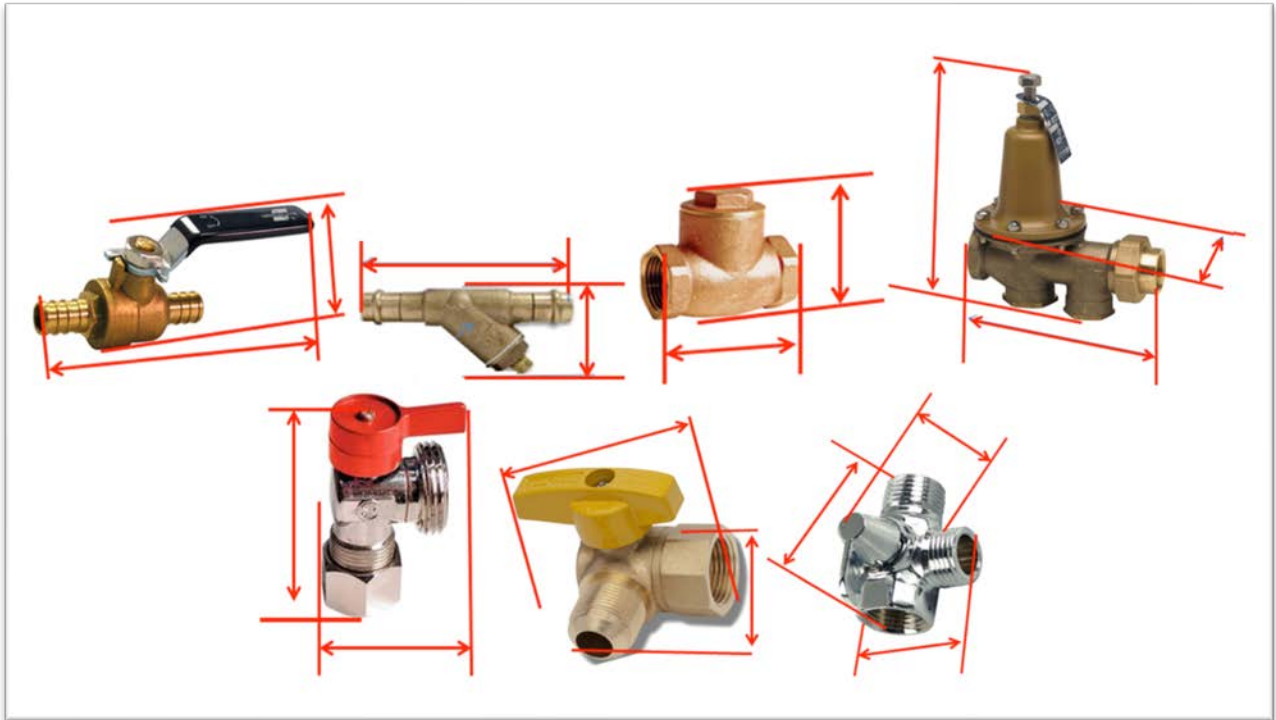
**Figure 4-87** Drainage - traps, drains, and wyes measurements.



#### 4.9.5.5 Unpackaged valves

While sitting on a flat surface such as a table with at least one opening side facing 3 o'clock. The surface facing you is the Default Front Measurements are taken left to right, 12 o'clock position to the 6 o'clock position and from the table surface to the outer most point of the Default Front. Measurements are: Longest = Depth, Next longest = Width, Shortest = Height. If there is a handle it will be in the as shipped orientation

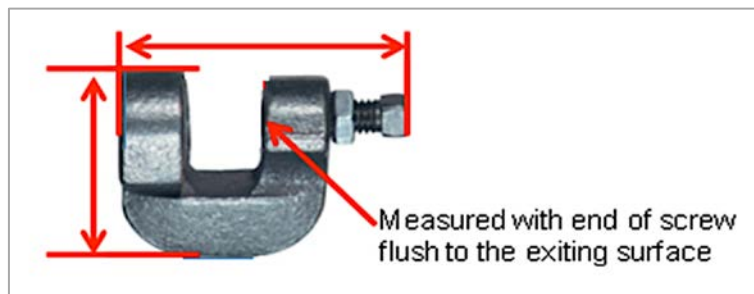
**Figure 4-88** Unpackaged valve measurements.



**4.9.5.6 Loose pipe clamps and hangers**

The Default Front is the surface facing you looking down on the clamp, laying on a flat surface, with the screw oriented to the 3 o'clock position. Measurements are taken left to right, 12 o'clock position to the 6 o'clock position and from the table surface to the outer most point of the Default Front. Measurements are: Longest = Depth, Next longest = Width, Shortest = Height

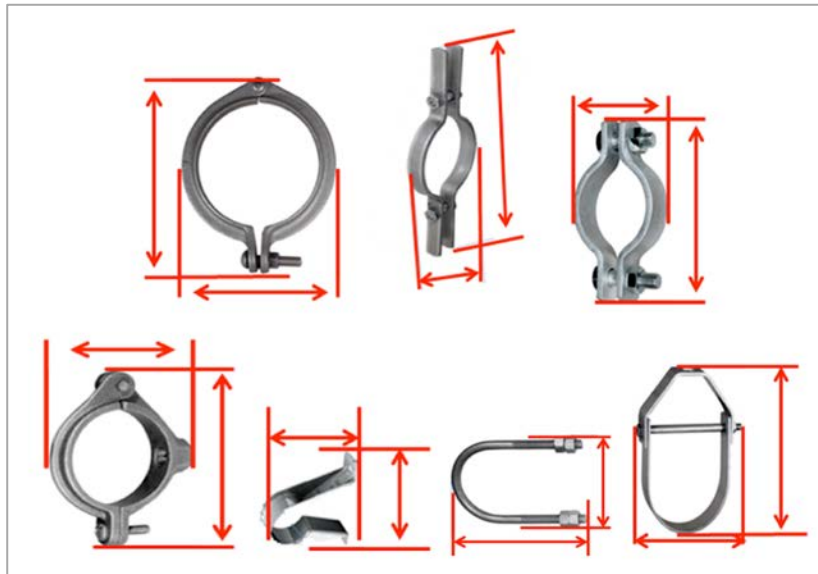
**Figure 4-89** Loose pipe clamp and hanger measurements.



**4.9.5.7 Loose pipe hangers**

Pipe hangers with screws or other fasteners are measured placed on a flat surface such as a table with one of the fasteners pointing to the 3 o'clock position. Hangers with open end (“non-clamping”) are positioned with open end at 3 o'clock position. The Default Front is the surface facing you looking down on it. Measurements are taken left to right, 12 o'clock position to the 6 o'clock position and from the table surface to the outer most point of the Default Front. Measurements are: Longest = Depth, Next longest = Width, Shortest = Height

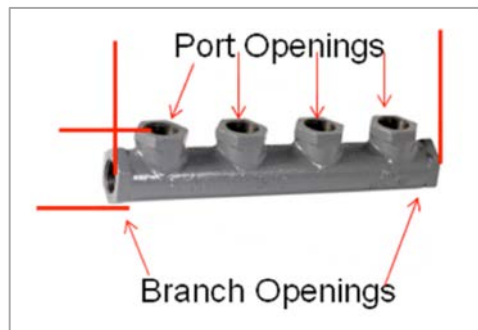
**Figure 4-90** Loose pipe hanger measurements.



**4.9.5.8 Manifolds**

Manifolds are positioned with a branch opening in the 3 o'clock position. Measurements are taken left to right, 12 o'clock position to the 6 o'clock position and from the table surface to the outer most point of the Default Front. Measurements are: Longest = Depth, Next longest = Width, Shortest = Height

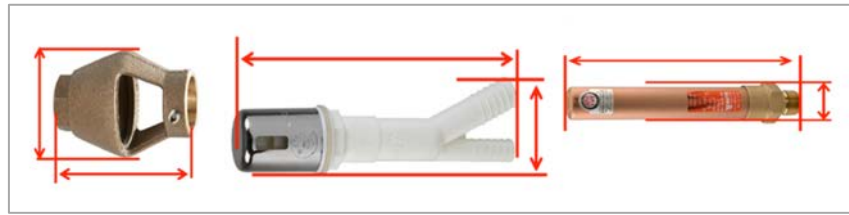
**Figure 4-91** Manifold measurements.



**4.9.5.9 Air gaps, hammer arrestors**

While sitting on a flat surface such as a table with at least one opening side facing 3 o'clock. The surface facing you is the Default Front Measurements are taken left to right, 12 o'clock position to the 6 o'clock position and from the table surface to the outer most point of the Default Front. Measurements are: Longest = Depth, Next longest = Width, Shortest = Height

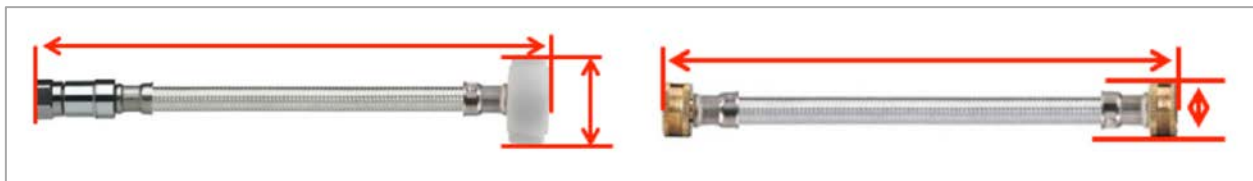
**Figure 4-92** Air gaps and hammer arrestor measurements.



**4.9.5.10 Connectors and supply lines**

Connectors and supply lines are positioned with an opening in the 3 o'clock position. Measurements are taken left to right, 12 o'clock position to the 6 o'clock position and from the table surface to the outer most point of the Default Front. Measurements are: Longest = Depth, Next longest = Width, Shortest = Height

**Figure 4-93** Connector and supply line measurements.



**4.10 Soft paper products with a vertical core – Paper towels & toilet paper**

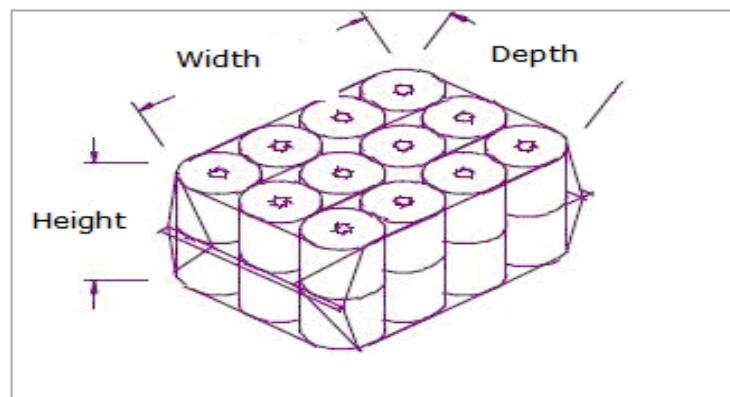
**4.10.1 Overview**

This section covers the measurement of Soft Paper products with a vertical core (Toilet paper, Paper towels) where the placement of promotional art could change the default front under current rules.

**4.10.2 Determining the Default Front of soft paper products**

The Default Front for paper products where the product is either wrapped around a paperboard core or where the product is rolled/spooled around a vertical centre but without the paperboard core, would be determined with the core or the centre of the spooled product in a vertical orientation as shown:

**Figure 4-94** Determining default front



**Step 1-** Position the core(s) vertically

**Step 2-** Establish the Default Front - The default front is the side panel with the largest surface area used by the manufacturer to “sell” the product to the consumer, in other words, the side panel with markings such as the product name.

**Step 3-** While facing the default front, determine the height, width and depth as follows:

- Height: From the base to the top, positioning the core(s) vertically to the store shelf.
- Width: From the left to the right.
- Depth: From the front to the back.

## 4.11 Large flexible packages

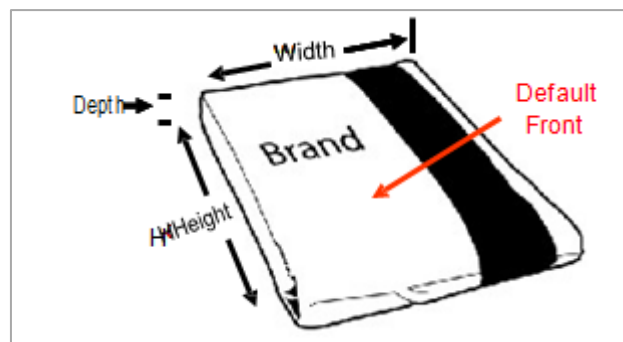
### 4.11.1 Overview

This section covers the measurement of large flexible packages with a declared net content of **greater than fifteen pounds (6.8 kilograms)**.

### 4.11.2 Determining the Default Front of large flexible packages

The Default Front is the side with the largest surface area that is used by the manufacturer to “sell” the product to the consumer, in other words, the side with markings such as the product name.

**Figure 4-95** Large flexible packages



These trade items will be measured edge to edge including any sealed seams with the item lying flat after evenly settling the contents. The measurements are taken while facing the trade item’s Default Front, and after having pulled out and then released the seams.

While facing the trade item’s Default Front:

- Height is the measurement from the bottom most point to the top most point
- Width is measured from the left most point to the right most point
- Depth is measured from the Default Front to the flat surface the trade item is lying on

Examples of this type of trade item include bags of pet food, charcoal, and kitty litter.

## 4.12 Cheese wheel and wedge

The default front of a wheel of cheese is always identified by looking on the largest side of the wheel. The same view is assumed if a slice (sector) of a full wheel of cheese is to be measured. Labels or print marks are not taken into consideration when identifying the default front.

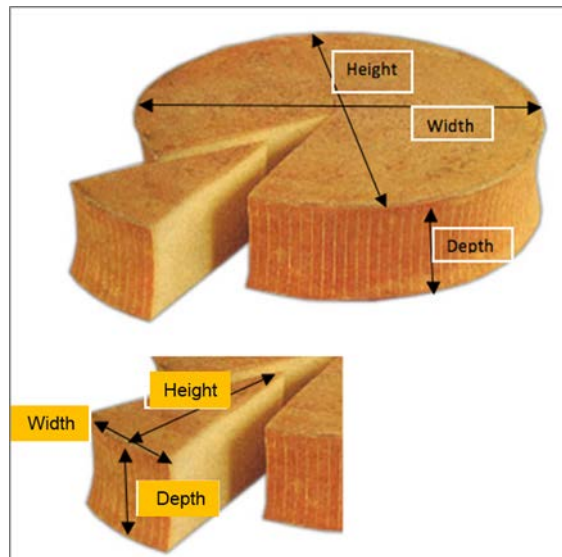
### 4.12.1 Measurement of a wedge of cheese (wheel)

Place the section on a flat surface on its diameter/radius with at least one radius in the 12 o’clock to 6 o’clock position. Measurements are made while facing the diameter/radius = Default Front Height

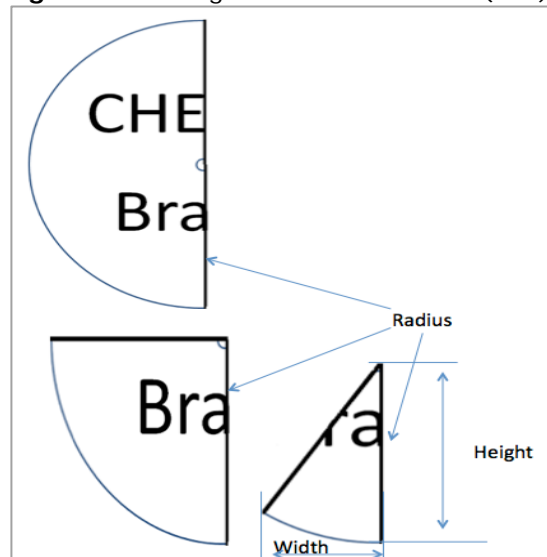
is from farthest point of the 6 o'clock position to the farthest point of the 12 o'clock position. Width is from the rightmost point to the leftmost point. Depth is from the flat surface to the Default Front.

1. place wheel on a flat surface, on its diameter
2. Default Front facing the graphics if any
3. the diameter is the Height and Width
4. the thickness or third dimension is the Depth

**Figure 4-96** Cheese wheel (3D colour)



**Figure 4-97** Diagram of cheese wheel (b/w)



**!** **Important:** For irregular wedge cuts the largest straight edge is always the radius; as shown below in the lower left corner of the graphics above.

#### 4.13 Determining the marketing/usable sizes

Additionally to trade item sizes, there are some products for which marketing sizes are also essential for the end consumer. This section defines these additional sizes.

**!** **Important:** the product is best placed on a flat surface to make these measurements

#### 4.13.1 Usable diameter

- Diameter of the highest circular usable surface of the product when it is placed on a flat surface. The usable part of the product is the part meant for the intended purpose of the product for example an inner section of a bowl or inner diameter of a flower pot:
  - Attribute Name: sizeTypeCode
  - Code Value: USABLE\_DIAMETER

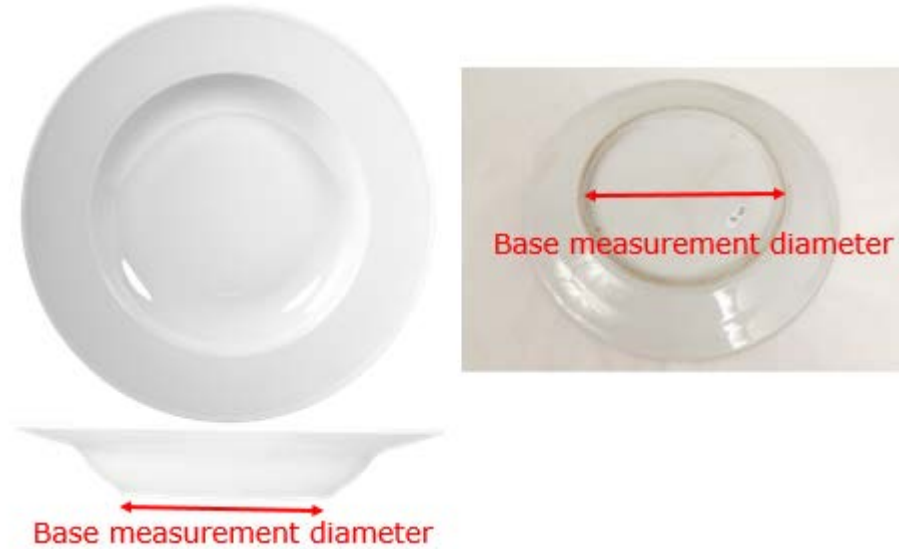
**Figure 4-98** Examples of Usable diameter



#### 4.13.2 Base measurement diameter

- Diameter of the product base in contact with the floor, table or other plane surface:
  - Attribute Name: sizeTypeCode
  - Code Value: BASE\_MEASUREMENT\_DIAMETER

**Figure 4-99** Example of Base measurement diameter



#### 4.13.3 Usable height

- Measurement of the distance from the highest point of the usable part of the product, when it is placed on its principal base on a flat surface, to its internal bottom:
  - Attribute Name: sizeTypeCode
  - Code Value: USABLE\_HEIGHT

**Figure 4-100** Example of Usable height



#### 4.13.4 Usable width

- Measurement of the distance from the left to the right inner rims when the product is placed on its principal base on a flat surface:
  - Attribute Name: sizeTypeCode
  - Code Value: USABLE\_WIDTH

**Figure 4-101** Example of Usable width



#### 4.13.5 Usable depth

- Measurement of the distance from the front to the back inner rims of the product when it is placed on its principal base on a flat surface:
  - Attribute Name: sizeTypeCode
  - Code Value: USABLE\_DEPTH

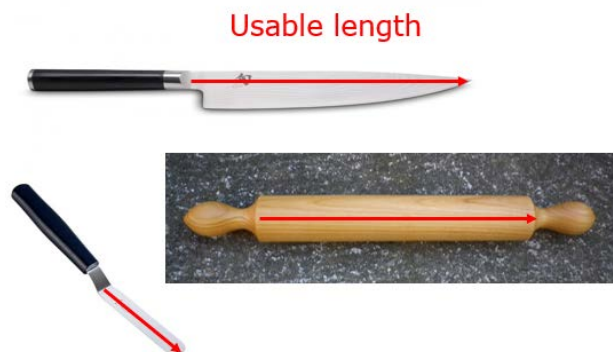
**Figure 4-102** Example of Usable depth



#### 4.13.6 Usable length

- Total length of the product minus the length of additional elements for its usage (Length of a knife blade, length of a nail file rocky surface):
  - Attribute Name: sizeTypeCode
  - Code Value: USABLE\_LENGTH

**Figure 4-103** Example of Usable length



## 5 Non-consumer trade item

### 5.1 Overview

These trade items are identified with a GTIN and are intended for General Distribution scanning. This includes outer cases up to the largest form of bulk packaging for trade items and may include pallets or units such as sea containers if they are explicitly traded. The orientation of a Non-consumer trade item to determine dimensions **will not be dependent on how it is shipped**. Take note that for non-consumer trade items, the terms Depth and Length may be used interchangeably.

Trade items that are otherwise identical to those intended to cross point of sale, but not identified with a bar code approved for point of sale scanning, will be measured as non-consumer trade items. Examples include condiments and cleaning materials used in foodservice applications. Always measure the maximum distance, i.e. include things such as projections, caps, lids etc. in the measurement.

### 5.2 Determining the natural base

- The natural base of the non-consumer trade item must be identified before the height, width and depth of the non-consumer trade item can be determined. The natural base is the natural underside of the packaged item pre-shipment (e.g., case).

#### For consistency in measuring:

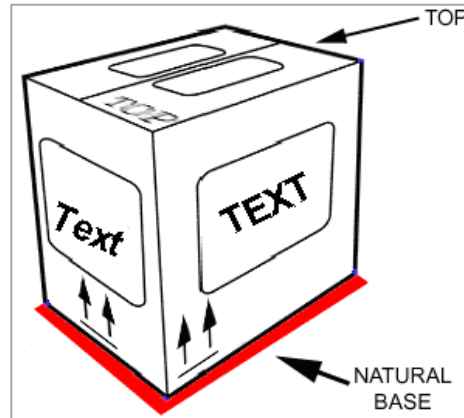
Determine if markings or packing design indicate the orientation use the following order of prioritisation:

1. If markings are present that indicate the correct package orientation, those markings SHALL be used to identify the natural base. Examples include:
  - Arrows
  - Directional words such as "top" or "bottom"
2. If neither arrows nor directional words appear:
  - Consistent text orientation, on one or more side, which is parallel to the surface (natural base) on which it sits
  - General distribution barcode(s) printed on the pack, which is parallel to the surface (natural base) on which it sits
3. If no orientation markings exist, the largest, flat surface upon which the package naturally rests SHALL be considered the natural base.
  - If a clearly intended opening is present, that side should be considered the top of the package. This does not include perforations.
  - Non-consumer trade items where the package or part of a package's shape can be readily changed (e.g., flexible packaging) should be measured lying flat with the contents settled.



**Important:** See specifics for determining the natural base for Display boxes (section [5.3](#)) and Shrink packs (section [5.4](#)) below.

**Figure 5-1** Natural base orientation

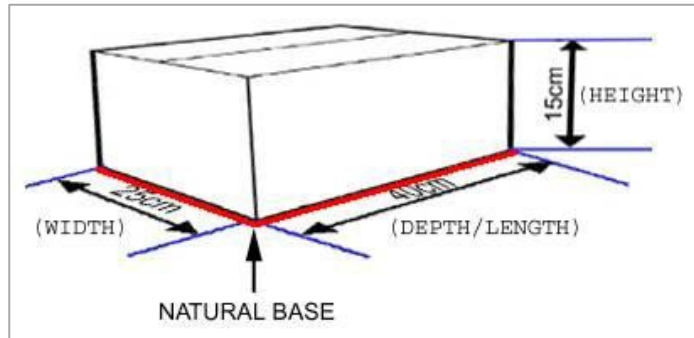


- After it has been established which side is the natural base, the height, width and depth of the non-consumer trade item can be determined.
  - **Height:** the distance between the natural base of the non-consumer trade item and the top.
  - **Width:** the shorter side of the natural base of the non-consumer trade item.
  - **Depth/Length:** the longer side of the natural base of the non-consumer trade item.

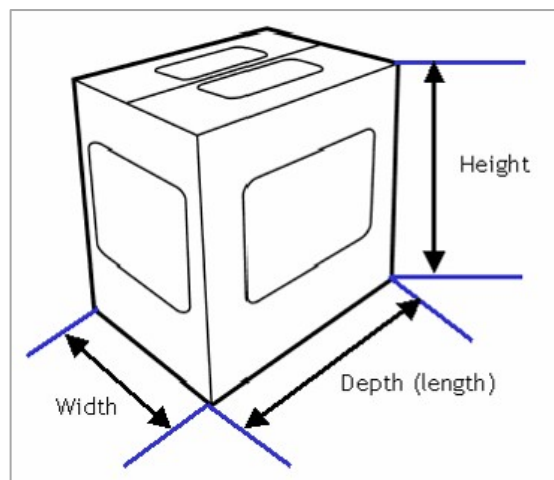
**Remarks, Exceptions:**

- In case of a square base there is no shortest or longest side. Width and depth are then identical.
- **Make sure you capture any protrusions that may extend the above, such as handles.**
- When measuring a trade item the maximum measure should be recorded for any given dimension.

**Figure 5-2** Maximum measure



**Figure 5-3** Dimensions of non-consumer trade items (outer case)

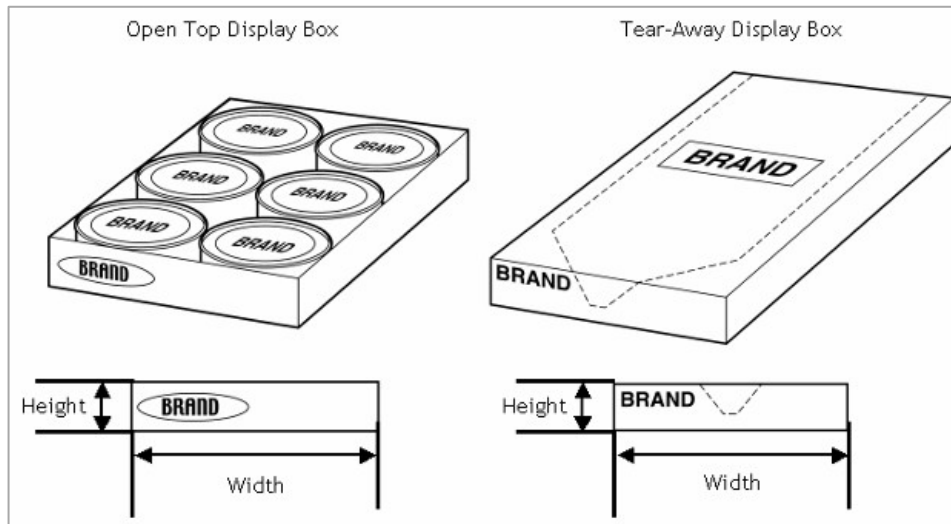


It is important that the measurement of non-consumer trade items is done in a free and unrestricted manner (e.g., not in a stack). The item being measured must also be in good condition and not damaged (e.g., damp, torn).

### 5.3 Display boxes

The natural base rule is used to measure display boxes. This rule is independent of whether the display box has an open top or a tear-away top.

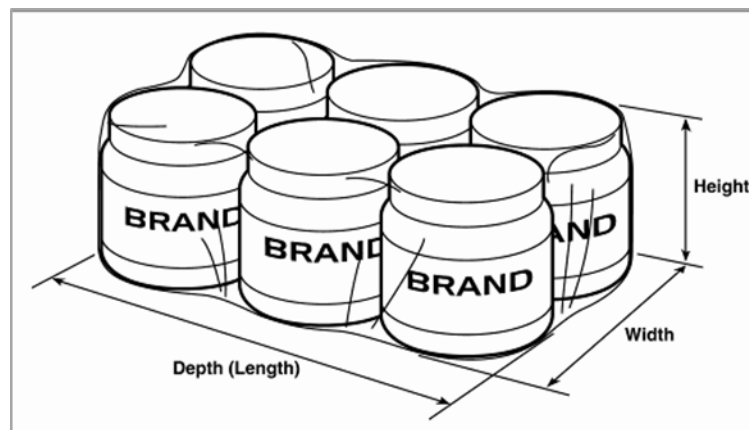
**Figure 5-4** Dimensions of non-consumer trade items (display box)



### 5.4 Shrink packs

Shrink-Packs are defined as groups of consumer trade items shrink-wrapped together for the purpose of being a shipping container.

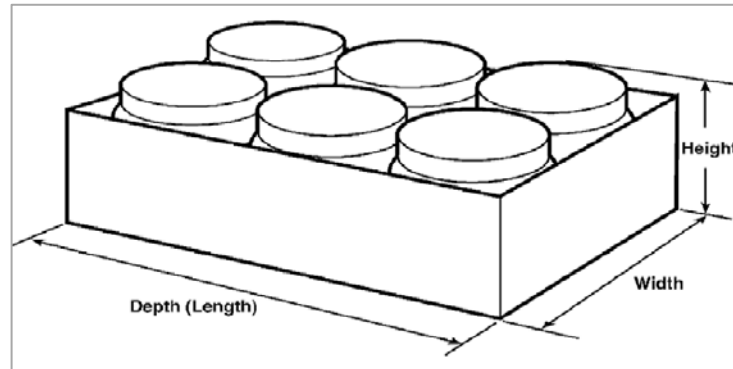
**Figure 5-5** Dimensions of non-consumer trade items (shrink pack)



#### 5.4.1 Tray packs

Tray-Packs are defined as groups of consumer trade items packaged for shipment in a tray, which provides a bottom structure and some structure to the four sides with no top structure.

**Figure 5-6** Dimensions of non-consumer trade items (tray-packs)



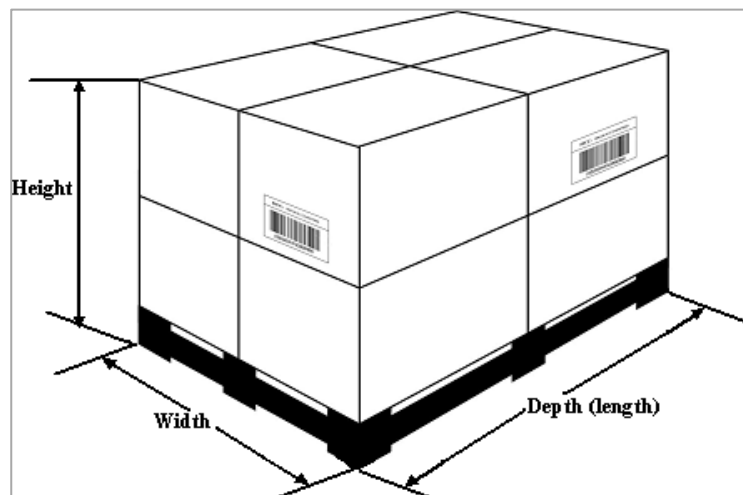
#### 5.4.2 Floor ready displays

Floor and counter displays may be shipped unassembled. The shipping container for the unassembled display is measured as any other non-consumer trade item using the natural base rule.

#### 5.4.3 Unit loads on shipping platforms

The natural base rule is used to measure Unit Loads on Shipping Platforms.

**Figure 5-7** Dimensions of unit loads on shipping platforms

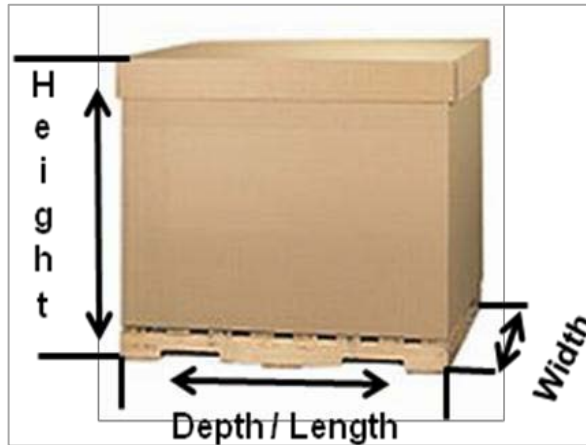


**Note:** The height, width, depth, and gross weight of the shipping platform is not always included in the dimension information. To designate exclusion of shipping platform level measurements the **PalletTypeCodeList** code value must be set accordingly.

#### 5.5 Bulk loads on shipping platforms

The natural base rule is used to measure Bulk Loads on Shipping Platforms. An example of this type of container is the tote box used in foodservice applications as shown below.

**Figure 5-8** Dimensions of bulk loads on shipping platforms



## 5.6 Buckets and pails

### 5.6.1 Determining natural base for buckets and pails

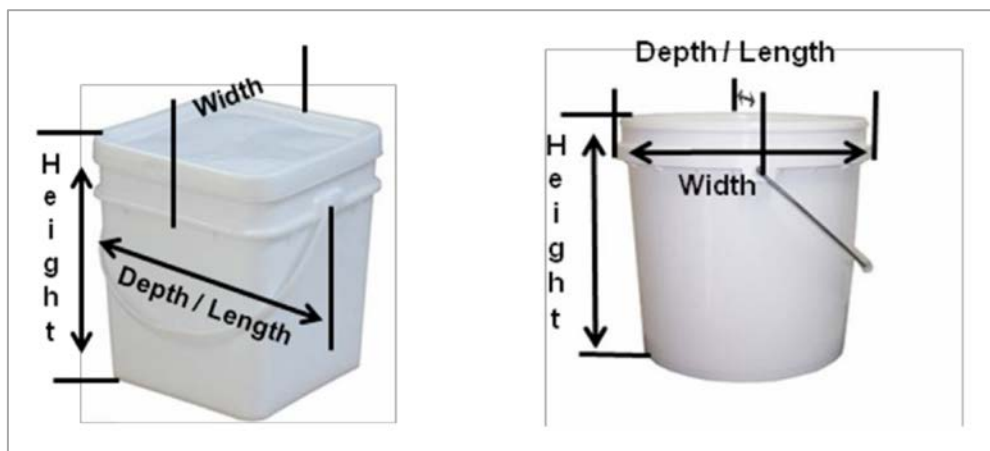
For the purposes of this standard, the natural base of a bucket or pail is defined as the surface opposite the opening surface of the container.

**Figure 5-9** Measuring buckets and pails



### 5.6.2 Measuring buckets and pails

**Figure 5-10** Measuring buckets and pails



While the bucket or pail is resting on the natural base, height, width and depth are determined as follows:


- Height is from the bottom most point to the top most point
- Depth is the widest horizontal surface. Always be sure to measure the maximum distance, including projections or handles.
- Width is the measurement of the bucket or pail 90 degrees from Depth measurement.

## 6 Standards tolerances for data accuracy

Work in this section was modified according to WR-12-00203 regarding minimum tolerances.

### 6.1 Overview

Physical products identified by the same GTIN have inherent variability in gross weights and linear dimensions due to manufacturing processes, handling methods, environment and other factors. Standard tolerances are defined as allowable variations between the STATED (synchronised) and MEASURED (actual) gross weights and linear dimensions of a GTIN. Any, more restrictive, local regulations governing the measurement of either weight or dimensions take precedence over these specifications. Acceptable standard tolerances are defined in the tables below. Tolerances for Non-consumer Trade items and Consumer Trade items have been separated into distinct tables.

 **Note:** Because variable measure items may vary to such an extent as they exceed the allowable tolerances for weight, the gross weight tolerances in these tables do not apply to variable weight trade items. As an alternative to gross weight tolerances, use the attributes associated with VariableTradeItemInformation, which allow for a percentage of deviation from the submitted gross weight (submitted being the average weight of the trade item), or a minimum and/or maximum weight range.

### 6.2 Standard tolerances for non-consumer trade items

The following table provides a summary of standard tolerances for non-consumer trade items:

**Table 6-1** Standard tolerances for non-consumer trade items (e.g., case unit)

Type	Content	Description	Example	Measurement	Tolerance +/-
Corrugated Case	Cardboard or pressboard box	Full enclosed corrugated case containing cartons or boxes	Cereal, Games, Puzzles, Mac & cheese, Facial tissue, Dog treats	Depth/Length Width Height Gross Weight	4.0% 4.0% 4.0% 4.0%
Corrugated Case	Metal cans or Glass jars/bottles	Full enclosed corrugated case containing cans or glass jars	Vegetables, Fruit, Aerosol, Cat & dog food, Steak sauce, and Condiments	Depth/Length Width Height Gross Weight	4.0% 4.0% 4.0% 4.0%
Corrugated Case	Rigid plastic containers	Full enclosed corrugated case containing rigid plastic containers	Shampoo, Laundry detergent, Clam shells, Baby wipes, Salad dressing, Water, Mayo, Ketchup, Beverages, Soups, Beans, Dog treats, Dish detergent, Cleaning products	Depth/Length Width Height Gross Weight	4.0% 4.0% 4.0% 4.0%

Type	Content	Description	Example	Measurement	Tolerance +/-
Plastic overwrap	Metal Cans or Glass jars/bottles	Tray or non-tray product with plastic overwrap containing cans, or glass jars	Water, Salad dressing, Mayo, Ketchup, Beverages, Soups, Beans, Dish detergent, & Cleaning products	Depth/Length Width Height Gross Weight	4.0% 4.0% 4.0% 4.0%
Plastic overwrap	Rigid plastic containers	Tray or non-tray product with plastic overwrap containing rigid plastic containers	Vegetables, Fruit, Aerosol, Cat & Dog food	Depth/Length Width Height Gross Weight	4.0% 4.0% 4.0% 4.0%
Soft paper products in flexible plastic packaging, and/or corrugated cases	Flexible plastic packaging, and/or corrugated cases	Flexible plastic packaging, or corrugated cases containing soft paper products	Toilet paper, Paper towels, Napkins, Baby care, Paper & plastic cups, Paper & plastic plates, Tissues	Depth/Length Width Height Gross Weight	5.0% 5.0% 5.0% 9.0%
Flexible Packaging in shrink wrapped outer wrap	Flexible packaging	Tray or non-tray product with plastic over-wrap	Pet food, Charcoal, Flour	Depth/Length Width Height Gross Weight	10.0% 10.0% 10.0% 4.0%
Flexible Packaging in corrugated cases	Flexible packaging	Full enclosed corrugated case containing flexible packaging	Bag of candy, Cheese chunk, Snack bags, Bags of coffee, Tray of cookies, Paper cups	Depth/Length Width Height Gross Weight	4.0% 4.0% 4.0% 4.0%
Frozen Trade Items Corrugated Case (See the note in the Example column)	Mixed inner packaging flexible or hard, tubs	Frozen items come in a full spectrum of trade item level packaging and placed in cases	Ice cream, Frozen dinners, Fries, Seafood, Vegetables, Fruits, Pizza, Popsicles etc. <b>NOTE:</b> Frozen flexible trade items shrink wrapped to make a case use flexible tolerances based on size shown above	Depth/Length Width Height Gross Weight	5.0% 5.0% 5.0% 6.0%


**Note:**

When the linear tolerance is:	The minimum tolerance dimension is:
4%	7 mm (0.25 in)
5%	8 mm (0.3125 in)
10%	13 mm (0.5 in)
When the Gross Wt. tolerance is:	The minimum weight tolerance is:
4%	0.1 kg (0.2 lb.)
6%	0.1 kg (0.2 lb.)
9%	0.2 kg (0.45 lb.)

### 6.2.1 Standard tolerance for very small non-consumer trade items

For non-consumer trade items that are very small and/or lightweight, separate tolerances must be applied, as of 2014 as the standard tolerances values listed in [Table 6-1](#) may be unpractical or potentially unattainable when measuring data accuracy. The very small non-consumer trade item tolerances will apply only to a specific range of dimensions and weights.

The following applies:

- For each dimension equal or less than 160 mm (6.25 in) a fixed tolerance of 7 mm (0.25 in) is applied, while for dimensions larger than 160 mm (6.25 in) see [Table 6-2](#).
- For each gross weight equal or less than 2.27 kg (5.0 lb) a fixed tolerance of 0.1 kg (0.2 lb) is applied, while for gross weights larger than 2.27 kg (5.0 lb) the table on the previous page is valid.
- If the cubic volume of an item is greater than 0.05 cubic metres (1.75 cubic feet) and the item gross weight is less than 5.5 kg (12 lb), a fixed tolerance of 0.25kg (0.5 lb) is applied to the gross weight. Standard tolerances apply to the linear dimensions of this item.

#### Example 1:

A manufacturer produces cases with GTIN 10012345678902, having the following dimensions and gross weight:

Depth/Length = 7.5 in (190 mm)

Width = 3.5 in (89 mm)

Height = 5.0 in (127 mm)

Gross Weight = 2.5 lb (1.14 kg)

The resulting tolerances would be:

Depth/Length is larger than 160 mm (6.25 in), so apply standard tolerance

**Tolerance depth/length = +/- 4% x 190 mm (7.5 in) = 7.6 mm (0.3 in)**

Width is less than 160 mm (6.25 in), so apply new tolerance

**Width tolerance = +/- 7mm (0.25 in)**

Height is less than 160 mm (6.25 in), so apply new tolerance

**Height tolerance = +/- 7mm (0.25 in)**

Gross weight is less than 2.27 kg (5.0 lb), so apply new tolerance

**Gross weight tolerance = +/- 0.1 kg (0.2 lb)**

#### Example 2:

A manufacturer produces cases with GTIN 10012345678919, having the following dimensions and gross weight:

Depth/Length = 375 mm (15 in)

Width = 375 mm (15 in)

Height = 500 mm (20 in)

Cubic Volume = 0.07 cubic m (2.6 cubic ft)

Gross Weight = 4.5 kg (10 lb)

The resulting tolerances would be:

Dimensions- standard tolerances apply

Gross Weight- Since cubic volume is more than 0.05 cubic m (1.75 cubic ft), then apply new fixed tolerance

**Gross weight tolerance = +/- 0.25 kg (0.5 lb)**

### 6.3 Standard tolerances for consumer trade items

The following table provides a summary of standard tolerances for consumer trade items:

**Table 6-2** Standard tolerances for consumer trade items (e.g., shelf unit)

Type	Description	Example	Measurement	Tolerance +/-
Carton	Full carton or cardboard box	Cereal, Games, Puzzles, Mac & cheese, Facial tissue, Dog treats	Depth Width Height	7 mm (0.25 in) 7 mm (0.25 in) 7 mm (0.25 in)
Can or Glass	Can or Glass container, completely rigid	Vegetables, Fruit, Aerosol, Cat & Dog food, Steak Sauce, Condiments, Coffee	Depth Width Height	7 mm (0.25 in) 7 mm (0.25 in) 7 mm (0.25 in)
Plastic container	Rigid bottle or plastic container, no flexibility	Water, Salad Dressing, Mayo, Ketchup, Beverages, Soups, Beans, Detergent, Clam shells, Baby wipes, Cleaning products	Depth Width Height	7 mm (0.25 in) 7 mm (0.25 in) 7 mm (0.25 in)
Soft Paper Products in Flexible plastic packaging	Flexible plastic packaging containing soft paper products	Toilet paper, Paper towels, Napkins, Baby care, Cups & plates, Tissues	Depth Width Height	13 mm (0.50 in) 13 mm (0.50 in) 13 mm (0.50 in)
Flexible outer-wrap (tight or loose fitting)	Flexible packaging: 1. Formed, Filled and Sealed without gussets 2. Stand-up pouches 3. Packaging whose size or shape is defined by contents 4. Gusseted bags or Block bottom bags	Potato Chips, Drink containers, Candy bars, Cookies in trays, Bread, Disposable cups, Pet food Cat litter, Charcoal, Snack foods, Flour, Baking mixes	Depth Width Height	20 mm (0.75 in) 20 mm (0.75 in) 20 mm (0.75 in)
Large Flexible Trade Items	Large flexible packages with a declared net content of greater than 6.8 kg (15 lb)	Pet food, Charcoal, Kitty litter	Depth Width Height Gross Weight	32 mm (1.25 in) 32 mm (1.25 in) 32 mm (1.25 in) 4.0 %
Small Rigid Trade Items with one or more dimensions less than or equal to 64 mm (2.50 in) and weighing up to 0.9 kg (2 lb).	Cans or glass containers, full carton or cardboard box, rigid plastic, carded products, clamshells <b>NOTE:</b> Excludes flexible packaging	Cosmetics, Pens, Markers, Craft supplies, Glue, Snack foods, Candy, Toys	Depth Width Height	4 mm (0.125 in) for each dimension equal or less than 64 mm (2.50 in)  7 mm (0.25 in) for each dimension greater than 64 mm (2.50 in)

### 6.3.1 Standard tolerances for very small rigid consumer trade items

For rigid consumer trade items with one or more dimensions equal to or less than 64 mm (2.50 in), the following revised tolerances must be applied, (as the standard tolerances values listed in the [Table 6-2](#) may be impractical or potentially unattainable when measuring data accuracy). Other dimension(s) greater than 64 mm (2.50 in) will continue to use the standard tolerances.

The following applies:

- For each dimension equal or less than 64 mm (2.50 in) a revised tolerance of 4 mm (0.125 in) is applied, while for dimensions larger than 64 mm (2.50 in) [Table 6-2](#) is valid. Be aware that other dimensions greater than 64 mm (2.50 in) will use the standard tolerances.

**Example:**

A manufacturer produces consumer trade items with GTIN 08712345123451, having the following dimensions:

- Depth/Length = 20 mm (0.79 in)
- Width = 190 mm (7.50 in)
- Height = 20 mm (0.79 in)

The resulting tolerances would be:

- Depth/Length is less than 64 mm (2.50 in), so apply revised tolerance  
**Depth/length tolerance = +/- 4 mm (0.125 in)**
- Width is larger than 64 mm (2.50 in), so apply standard tolerance  
**Width tolerance = +/- 7 mm (0.25 in)**
- Height is less than 64 mm (2.50 in), so apply revised tolerance  
**Height tolerance = +/- 4 mm (0.125 in)**

## 6.4 General notes on standards tolerances

- Refer to the [GDSN Package Measurement Rules Implementation Guide](#) for more information regarding data accuracy guidelines and implementation of tolerances.
- Soft paper products in flexible packaging at the consumer and case level are included in the above packaging types. Note that the tolerances for soft paper products are distinct from the tolerances for Flexible Packaging, which is defined separately above.
- Tolerance Standards have been established for Flexible Packaging Items weighing more than 6.8 kg (15 lb), Note that the tolerances for these products are distinct from the tolerances for Flexible Packaging, which are defined separately above.
- The proposed standard tolerances are not intended to replace parameters within the *GTIN Management Standard*, which identify when a new GTIN must be assigned.
- The dimensions and weight tolerances apply only to fixed measure products. Tolerances are not practical for variable measure products (e.g., variable weight products, etc.).
- Small rigid trade item tolerances exclude flexible packaging, which is defined separately elsewhere in this section.
- Frozen flexible trade items shrink wrapped to make a case use flexible tolerances based on size shown in [Table 6-1](#) for non-consumer trade items (e.g., cases, etc.).

## A Appendix: Stair parts and definitions

Figure A-1 Illustration reprinted with permission of Crown Heritage Stair Company

