



The Global Language of Business

GS1 General Specifications

The foundational GS1 standard that defines how identification keys, data attributes and barcodes must be used in business applications.

Release 17.1, Ratified, Jul 2017

Document Summary

Document item	Current value
Document name	GS1 General Specifications
Document type	Standard
Document date	Jul 2017
Document version	17.1
Document issue	
Document status	Ratified
Document description	The foundational GS1 standard that defines how identification keys, data attributes and barcodes must be used in business applications.

Change Log in this release

Impact on section	Gens Specs Change Notification (GSCN)	Summary of change
1	None	not applicable
2	GSCN for 16-528 GSCN for 16-534	AI 91 to 99 – Data length extension Identification of pieces that make up a trade item (shoes)
3	GSCN for 16-528 GSCN for 16-534 GSCN for 17-067	AI 91 to 99 – Data length extension Identification of pieces that make up a trade item (shoes) Consumer product variant (CPV)
4	GSCN for 16-534 GSCN for 17-067 GSCN for 17-073 GSCN for 17-092	Identification of pieces that make up a trade item (shoes) Consumer product variant (CPV) GTIN reuse cessation Multi-pallet trade item
5	GSCN for 16-524	GS1-128 Code Set Explanation
6	None	not applicable
7	None	not applicable
8	GSCN for 17-067	Consumer product variant (CPV)

Disclaimer

GS1[®], under its IP Policy, seeks to avoid uncertainty regarding intellectual property claims by requiring the participants in the Work Group that developed this **GS1 General Specifications Standard** to agree to grant to GS1 members a royalty-free licence or a RAND licence to Necessary Claims, as that term is defined in the GS1 IP Policy. Furthermore, attention is drawn to the possibility that an implementation of one or more features of this Specification may be the subject of a patent or other intellectual property right that does not involve a Necessary Claim. Any such patent or other intellectual property right is not subject to the licencing obligations of GS1. Moreover, the agreement to grant licences provided under the GS1 IP Policy does not include IP rights and any claims of third parties who were not participants in the Work Group.

Accordingly, GS1 recommends that any organisation developing an implementation designed to be in conformance with this Specification should determine whether there are any patents that may encompass a specific implementation that the organisation is developing in compliance with the Specification and whether a licence under a patent or other intellectual property right is needed. Such a determination of a need for licencing should be made in view of the details of the specific system designed by the organisation in consultation with their own patent counsel.

THIS DOCUMENT IS PROVIDED "AS IS" WITH NO WARRANTIES WHATSOEVER, INCLUDING ANY WARRANTY OF MERCHANTABILITY, NONINFRINGEMENT, FITNESS FOR PARTICULAR PURPOSE, OR ANY WARRANTY OTHERWISE ARISING OUT OF THIS SPECIFICATION. GS1 disclaims all liability for any damages arising from use or misuse of this Standard, whether special, indirect, consequential, or compensatory damages, and including liability for infringement of any intellectual property rights, relating to use of information in or reliance upon this document.

GS1 retains the right to make changes to this document at any time, without notice. GS1 makes no warranty for the use of this document and assumes no responsibility for any errors which may appear in the document, nor does it make a commitment to update the information contained herein.

GS1 and the GS1 logo are registered trademarks of GS1 AISBL.

Who should read the General Specifications?

Technical experts working with the GS1 system should read these specifications. They provide a global reference document covering all technical aspects of the GS1 system. Their primary objective is to define the international standard upon which individual GS1 Member Organisations can develop user documentation.

Navigator

These specifications have been developed as a reference document aimed primarily at GS1 Member Organisations (who also produce local language user manuals) and system engineers developing software based upon GS1 system standards. All aspects of the GS1 system are summarised in section 1, which is recommended for those wishing to become familiar with the GS1 system logic and terminology.

Each application section mandates the use of system features defined elsewhere in this document, such as check digits, element strings, data carriers, and barcode symbol placement. The sections of these *GS1 General Specifications* are:

- **Section 1 Basics and principles of the GS1 system:** Provides an introduction to the core components of the GS1 system.
- **Section 2 Application identification:** Provides a definition for each GS1 application using a template format. Each application is uniquely identified and contains a description, the associated GS1 key, its definition and links to relevant data structures and attributes (section 3), rules (section 4), carrier specifications (section 5), placement (section 6), and unique processing requirements (section 7).
- **Section 3 GS1 Application Identifier definitions:** Describes the meaning, structure, and function of the GS1 element strings so they can be correctly processed in users' application programs.
- **Section 4 Application rules:** Provides the rules for use of GS1 keys in their application environments. Differences in industries are included as well as the data relationship rules for GS1 Application Identifier use.
- **Section 5 Data carriers:** Provides a detailed description of the data carriers that are endorsed by GS1. It includes symbol specification tables for use in the supply chain operational environment as well as the related barcode production and quality assessment required to achieve excellent scan rates.
- **Section 6 Symbol placement guidelines:** Provides guidance on symbol placement as well as transport label standards and tag standards.
- **Section 7 AIDC validation rules:** Provides rules for validating and processing GS1 element strings without human intervention. Check digit and calendar date algorithms are also included.
- **Section 8 GS1 Standards glossary of Terms:** A standard vocabulary used throughout the GS1 system.

Table of Contents

1	Basics and principles of the GS1 system	13
1.1	The GS1 General Specifications.....	14
1.1.1	Introduction	14
1.1.2	Who should read these specifications	14
1.1.3	Foundational standard	14
1.1.4	Maintenance responsibility and management.....	15
1.1.5	The Barcodes & Identification Technical Group (BCID TG)	15
1.2	GS1 system principles.....	15
1.3	Identification system policies	15
1.3.1	Mandatory identifiers.....	15
1.3.2	Non-GS1 identifiers.....	15
1.3.3	GS1 Company Prefix	15
1.3.4	Carrier independence	15
1.3.5	GS1 business messages.....	16
1.4	The GS1 Identification System	16
1.4.1	Global, open versus restricted	16
1.4.2	GS1 Prefix	16
1.4.3	GS1-8 Prefix	17
1.4.4	GS1 Company Prefix	17
1.4.5	U.P.C. Prefix.....	18
1.4.6	U.P.C. Company Prefix	18
1.4.7	GS1 Identification Key.....	18
1.4.8	Character set	19
1.5	GS1 Company Prefix Allocation	19
1.6	Allocation	20
1.6.1	Acquisitions and mergers.....	20
1.6.2	Split or spin-off	21
1.7	Sunrise and sunset dates	22
2	Application identification	23
2.1	Trade items	24
2.1.1	Introduction	24
2.1.2	Fixed measure trade items – open supply chain.....	26
2.1.3	Fixed measure trade items packed in several individual pieces not scanned at POS	50
2.1.4	Direct marking	52
2.1.5	Variable measure trade items – packages / containers not scanned in general retail at point-of-sale	55
2.1.6	Fixed measure trade items – restricted distribution	62
2.1.7	Variable measure trade items scanned in general retail at POS.....	67
2.1.8	Trade item extended packaging.....	71
2.2	Logistic units.....	74
2.2.1	Individual logistic units	74
2.2.2	Multiple logistic units – Global Identification Number for Consignment.....	76
2.2.3	Multiple logistic units – Global Shipment Identification Number.....	77
2.3	Assets	78
2.3.1	Global Returnable Asset Identifier (GRAI): AI (8003)	78
2.3.2	Global Individual Asset Identifier (GIAI): AI (8004).....	79

2.4	Locations and parties	82
2.4.1	GLN definition	82
2.4.2	GLN in electronic data sharing standards	82
2.4.3	Application overview	83
2.5	Service relationships.....	89
2.5.1	Global Service Relation Number – Provider: AI (8017).....	89
2.5.2	Global Service Relation Number – Recipient: AI (8018)	90
2.5.3	Service Relation Instance Number: AI (8019).....	92
2.6	Special applications	93
2.6.1	Coupons	93
2.6.2	Coupons identified using the Global Coupon Number	93
2.6.3	Coupons with restricted geographic distribution	97
2.6.4	Refund receipts	102
2.6.5	Electronic serial identifier for cellular mobile telephones (CMTI): AI (8002)	103
2.6.6	Payment slips.....	104
2.6.7	Customer specific articles	106
2.6.8	Custom trade item	111
2.6.9	Global Document Type Identifier for document control	113
2.6.10	Internal applications.....	119
2.6.11	Consumer trade item production control	119
2.6.12	Component / part identification	121
2.7	Summary of applications and operative scanning environments for GS1 system symbols.....	124
3	GS1 Application Identifier definitions	127
3.1	Introduction.....	128
3.2	GS1 Application Identifiers in numerical order.....	129
3.3	GS1 Application Identifiers starting with digit 0	134
3.3.1	Identification of a logistic unit (SSCC): AI (00)	134
3.3.2	Identification of a trade item (GTIN): AI (01)	134
3.3.3	Identification of trade items contained in a logistic unit: AI (02)	135
3.4	GS1 Application Identifiers starting with digit 1	135
3.4.1	Batch or lot number: AI (10).....	135
3.4.2	Production date: AI (11).....	136
3.4.3	Due date for amount on payment slip: AI (12)	136
3.4.4	Packaging date: AI (13).....	137
3.4.5	Best before date: AI (15).....	137
3.4.6	Sell by date: AI (16)	138
3.4.7	Expiration date: AI (17).....	139
3.5	GS1 Application Identifiers starting with digit 2	139
3.5.1	Internal product variant: AI (20)	139
3.5.2	Serial number: AI (21)	140
3.5.3	Consumer product variant: AI (22)	140
3.5.4	Additional product identification assigned by the manufacturer: AI (240).....	141
3.5.5	Customer part number: AI (241)	141
3.5.6	Made-to-Order variation number: AI (242)	141
3.5.7	Packaging component number: AI (243).....	142
3.5.8	Secondary serial number: AI (250)	142
3.5.9	Reference to source entity: AI (251)	143

3.5.10	Global Document Type Identifier (GDTI): AI (253)	143
3.5.11	GLN extension component: AI (254)	144
3.5.12	Global Coupon Number (GCN): AI (255)	144
3.6	GS1 Application Identifiers starting with digit 3	145
3.6.1	Variable count of items: AI (30)	145
3.6.2	Trade measures: AIs (31nn, 32nn, 35nn, 36nn)	145
3.6.3	Logistic measures: AIs (33nn, 34nn, 35nn, 36nn)	146
3.6.4	Kilograms per square metre: AI (337n)	147
3.6.5	Count of trade items contained in a logistic unit: AI (37)	148
3.6.6	Amount payable or coupon value - Single monetary area: AI (390n)	148
3.6.7	Amount payable and ISO currency code: AI (391n)	149
3.6.8	Amount payable for a variable measure trade item – Single monetary area: AI (392n)	149
3.6.9	Amount payable for a variable measure trade item and ISO currency code: AI (393n)	150
3.6.10	Percentage discount of a coupon: AI (394n)	151
3.7	GS1 Application Identifiers starting with digit 4	151
3.7.1	Customer’s purchase order number: AI (400)	151
3.7.2	Global Identification Number for Consignment (GINC): AI (401)	152
3.7.3	Global Shipment Identification Number (GSIN): AI (402)	152
3.7.4	Routing code: AI (403)	153
3.7.5	Ship to - Deliver to Global Location Number: AI (410)	153
3.7.6	Bill to - Invoice to Global Location Number: AI (411)	154
3.7.7	Purchased from Global Location Number: AI (412)	154
3.7.8	Ship for - Deliver for - Forward to Global Location Number: AI (413)	154
3.7.9	Identification of a physical location - Global Location Number: AI (414)	155
3.7.10	Global Location Number of the invoicing party: AI (415)	155
3.7.11	GLN of the production or service location: AI (416)	156
3.7.12	Ship to - Deliver to postal code within a single postal authority: AI (420)	156
3.7.13	Ship to - Deliver to postal code with three-digit ISO country code: AI (421)	156
3.7.14	Country of origin of a trade item: AI (422)	157
3.7.15	Country of initial processing: AI (423)	157
3.7.16	Country of processing: AI (424)	158
3.7.17	Country of disassembly: AI (425)	158
3.7.18	Country covering full process chain: AI (426)	159
3.7.19	Country subdivision of origin code for a trade item: AI (427)	159
3.8	GS1 Application Identifiers starting with digit 7	160
3.8.1	Seven series AIs - Cautionary note	160
3.8.2	NATO Stock Number (NSN): AI (7001)	160
3.8.3	UN/ECE meat carcasses and cuts classification: AI (7002)	160
3.8.4	Expiration date and time: AI (7003)	161
3.8.5	Active potency: AI (7004)	161
3.8.6	Catch area: AI (7005)	162
3.8.7	First freeze date: AI (7006)	162
3.8.8	Harvest date: AI (7007)	163
3.8.9	Species for fishery purposes: AI (7008)	163
3.8.10	Fishing gear type: AI (7009)	164
3.8.11	Production method: AI (7010)	164
3.8.12	Refurbishment lot ID: AI (7020)	165
3.8.13	Functional status: AI (7021)	165
3.8.14	Revision status: AI (7022)	165

3.8.15	Global Individual Asset Identifier of an assembly: AI (7023)	166
3.8.16	Number of processor with three-digit ISO country code: AI (703s).....	166
3.8.17	National Healthcare Reimbursement Number (NHRN): AIs (710), (711), (712), and (713) 167	
3.9	GS1 Application Identifiers starting with digit 8	169
3.9.1	Roll products - width, length, core diameter, direction, splices: AI (8001).....	169
3.9.2	Cellular mobile telephone identifier: AI (8002)	169
3.9.3	Global Returnable Asset Identifier (GRAI): AI (8003)	169
3.9.4	Global Individual Asset Identifier (GIAI): AI (8004).....	170
3.9.5	Price per unit of measure: AI (8005).....	170
3.9.6	Identification of an individual trade item piece: AI (8006).....	171
3.9.7	International Bank Account Number (IBAN): AI (8007).....	171
3.9.8	Date and time of production: AI (8008).....	172
3.9.9	Component / Part Identifier (CPID): AI (8010)	172
3.9.10	Component / Part Identifier serial number: AI (8011)	172
3.9.11	Software version: AI (8012).....	173
3.9.12	Global Service Relation Number (GSRN): AIs (8017, 8018).....	173
3.9.13	Service Relation Instance Number (SRIN): AI (8019)	174
3.9.14	Payment slip reference number: AI (8020)	174
3.9.15	Coupon code identification for use in North America (AI 8110)	175
3.9.16	Loyalty points of a coupon: AI (8111)	175
3.9.17	Paperless coupon code identification for use in North America (AI 8112).....	175
3.9.18	Extended packaging URL: AI (8200).....	176
3.10	GS1 Application Identifiers starting with digit 9	176
3.10.1	Information mutually agreed between trading partners: AI (90)	176
3.10.2	Company internal information: AIs (91 - 99).....	177
3.11	Compatibility of EPC Tag Data Standard and GS1 General Specifications	177
4	Application rules and management practices.....	178
4.1	Introduction.....	179
4.2	Rules for keys	180
4.2.1	GTIN rules	180
4.2.2	SSCC rules.....	180
4.2.3	Rules for GS1 asset identifiers	180
4.2.4	GLN rules.....	180
4.2.5	GSRN rules	180
4.2.6	GDTI rules	181
4.2.7	GINC rules	181
4.2.8	GSIN rules	181
4.2.9	GCN rules	181
4.2.10	CPID rules	181
4.3	GTIN rules.....	181
4.3.1	Management of uniqueness.....	181
4.3.2	Allocating the numbers.....	181
4.3.3	Responsibility for allocating the Global Trade Item Number.....	184
4.3.4	Sector-specific rules.....	184
4.3.5	Lead time in reusing a GTIN.....	186
4.3.6	Data alignment.....	187
4.4	SSCC rules.....	188

4.4.1	Allocating Serial Shipping Container Codes.....	188
4.5	Rules for GS1 asset identifiers	188
4.5.1	General rule.....	188
4.5.2	Allocating Global Returnable Asset Identifiers (GRAIs): AI (8003).....	188
4.5.3	Allocating Global Individual Asset Identifiers (GIAIs): AI (8004)	189
4.5.4	Change of asset ownership	190
4.5.5	Information associated with asset identifiers	190
4.6	GLN rules	190
4.6.1	Allocating Global Location Numbers.....	190
4.6.2	Information associated with a Global Location Number	192
4.6.3	GLN Allocation rules	192
4.7	GSRN rules	193
4.7.1	Allocating Global Service Relation Numbers.....	193
4.8	GDTI rules.....	194
4.8.1	Allocating Global Document Type Identifiers.....	194
4.8.2	GDTI change rules	194
4.9	GINC rules.....	195
4.9.1	Allocating Global Identification Numbers for Consignment.....	195
4.10	GSIN rules.....	195
4.10.1	Allocating Global Shipment Identification Numbers.....	195
4.11	GCN rules	195
4.11.1	Allocating Global Coupon Numbers.....	195
4.12	CPID rules	195
4.12.1	Allocating Component/Part Identifiers	195
4.13	Data relationships	196
4.13.1	Invalid pairs of element strings.....	196
4.13.2	Mandatory association of element strings.....	197
4.14	Human readable interpretation (HRI) rules	202
4.14.1	Healthcare human readable interpretation rules.....	204
4.14.2	Manual date marking.....	206
4.15	Multiple barcode management practices for consumer trade items (cross-sector) ..	207
4.15.1	Multiple barcode management practices for consumer trade items (all sectors)	207
4.15.2	GS1 multiple barcode management practice for general retail	208
4.15.3	GS1 multiple barcode management practices for healthcare.....	208
5	Data carriers.....	211
5.1	Introduction.....	212
5.1.1	International standards	214
5.1.2	Symbology identifiers.....	215
5.2	Linear barcodes - EAN/UPC symbology specifications.....	216
5.2.1	Symbology characteristics.....	216
5.2.2	Reference decode algorithm	226
5.2.3	Human readable interpretation	229
5.2.4	Additional features.....	230
5.3	Linear barcodes - ITF-14 symbology specifications.....	237
5.3.1	Symbology characteristics.....	237
5.3.2	Symbol structure	237
5.3.3	Additional features (informative)	241
5.3.4	Guidelines for the use of ITF-14 (informative)	241

5.3.5	Symbology identifier (informative)	242
5.3.6	Test specifications (informative)	242
5.4	Linear barcodes - GS1-128 symbology specifications	244
5.4.1	GS1-128 symbology characteristics	244
5.4.2	GS1-128 barcode structure	245
5.4.3	GS1-128 symbology character assignments	245
5.4.4	Dimensional requirements	252
5.4.5	Reference decode algorithm	252
5.4.6	Symbol quality	254
5.4.7	GS1-128 symbology application parameters	256
5.5	Barcode production and quality assessment	259
5.5.1	Introduction	259
5.5.2	Dimensional specifications and operational requirements	259
5.5.3	Barcode production	282
5.6	Linear barcodes – GS1 DataBar	305
5.6.1	Introduction	305
5.6.2	Symbol structure	306
5.6.3	Print quality grade	315
5.6.4	Advice for selecting the symbology	316
5.7	Two dimensional barcodes – GS1 DataMatrix symbology	317
5.7.1	Introduction	317
5.7.2	GS1 DataMatrix features and symbol basics	317
5.7.3	GS1 DataMatrix symbology	318
5.8	Composite barcodes	323
5.8.1	Composite symbology introduction	323
5.8.2	Symbol structure	324
5.8.3	Human readable interpretation of Composite symbols	329
5.8.4	Data transmission and symbology identifier prefixes	329
5.8.5	Width of a module (X)	330
5.8.6	Print quality	330
5.8.7	Advice for selecting a symbology	330
5.8.8	Sample Composite symbols	331
5.9	Two dimensional barcodes – GS1 QR Code symbology	334
5.9.1	Introduction	334
5.9.2	GS1 QR Code features and symbol basics	334
5.9.3	Summary of additional features	335
5.9.4	GS1 QR Code symbology	336
5.10	Appendix: Rules for encoding/decoding element strings in GS1 symbologies using GS1 Application Identifiers	341
5.10.1	The basic structure of GS1 barcodes using GS1 Application Identifiers and concatenation 341	
5.10.2	Concatenation	342
5.10.3	GS1 Application Identifiers with implied decimal point positions	345
6	Symbol placement guidelines	346
6.1	Introduction	347
6.2	General placement principles	347
6.2.1	Number of symbols	347
6.2.2	Scanning environment	347

6.2.3	Orientation	347
6.3	General placement guidelines for point-of-sale.....	351
6.3.1	Number of symbols.....	351
6.3.2	Identifying the back of the trade item	351
6.3.3	Symbol placement	351
6.4	Placement guidelines for specific package types.....	356
6.4.1	Bags	356
6.4.2	Blister packs	357
6.4.3	Bottles and jars	358
6.4.4	Boxes.....	359
6.4.5	Cans and cylinders.....	359
6.4.6	Carded items.....	360
6.4.7	Egg cartons.....	361
6.4.8	Jugs.....	361
6.4.9	Large, heavy, or bulky items.....	362
6.4.10	Multipacks	364
6.4.11	Publishing items	365
6.4.12	Thin items or containers	366
6.4.13	Trays	367
6.4.14	Tubes.....	368
6.4.15	Tubs	368
6.4.16	Unpackaged items	369
6.4.17	Sets (grouping of individually barcoded items)	371
6.4.18	Sporting goods	372
6.4.19	Textured surfaces	383
6.5	Symbol placement for clothing and fashion accessories.....	384
6.5.1	Information zones concept.....	385
6.5.2	Hangtag (hanging label) format.....	386
6.5.3	Sewn-on (joker) label format	388
6.5.4	Sewn-in label formats	389
6.5.5	Plastic packaged products label location guidelines.....	390
6.5.6	Boxed products label formats	392
6.5.7	Banded products label formats	395
6.6	GS1 Logistics Label design	397
6.6.1	Scope.....	397
6.6.2	Concepts	397
6.6.3	GS1 Logistics Label design	397
6.6.4	Technical specifications.....	400
6.6.5	Label examples.....	401
6.7	Symbol placement used in general distribution.....	406
6.7.1	General rule.....	406
6.7.2	Recommendation to include a barcode on two sides	408
6.7.3	Add-on symbols.....	408
6.8	Symbol placement for regulated healthcare trade items	410
6.8.1	Blister cells	410
6.8.2	Products requiring variable data on primary and secondary packaging.....	410
7	AIDC validation rules	411
7.1	Introduction.....	412

7.2	Synopsis of message processing	413
7.2.1	Analysis of the data carrier and plausibility test for element strings.....	414
7.2.2	Symbology identification.....	414
7.2.3	Prefix in internal table	414
7.2.4	Item Identification	415
7.2.5	GS1 Application Identifier (AI) in internal table.....	415
7.2.6	Length of Data 14 Digits	415
7.2.7	Check digit calculation and other system checks	415
7.2.8	Move element string to message field.....	415
7.3	Validation of the electronic message regarding system consistency	416
7.4	Validation of the electronic message regarding user requirements.....	417
7.5	Conversion of weights and measures in user applications	417
7.6	Linkage of GTINs in a database.....	419
7.6.1	The principle	419
7.6.2	Extended example of a trade item hierarchy	420
7.6.3	Linkage of GTINs in a non-relational database by trade item manufacturer	421
7.7	Element strings represented in data carriers	421
7.7.1	Element strings represented in GS1 system data carriers.....	422
7.7.2	Element strings represented in a GS1 symbology using GS1 Application Identifiers	423
7.8	Processing of data from a GS1 symbology using GS1 Application Identifiers	424
7.8.1	General	425
7.8.2	Element strings with predefined lengths using GS1 Application Identifiers.....	425
7.8.3	The separator character and its value.....	425
7.8.4	National Healthcare Reimbursement Number (NHRN)	425
7.9	Check digit calculations.....	427
7.9.1	Standard check digit calculations for GS1 data structures	427
7.9.2	Check digit calculation for price/weight fields	427
7.9.3	Check digit calculation for the four-digit price field	428
7.9.4	Check digit calculation for the five-digit price field.....	429
7.10	GTIN-12 and RCN-12 in a UPC-E barcode	429
7.11	The GS1 subset of international standard ISO/IEC 646	431
7.12	Determination of century in dates.....	433
8	GS1 Standards glossary of terms	434
8.1	GS1 glossary of terms and definitions.....	435
8.2	GS1 abbreviations	445
8.3	Legacy (retired) terms.....	446

1 Basics and principles of the GS1 system

1.1	The GS1 General Specifications	14
1.2	GS1 system principles	15
1.3	Identification system policies	15
1.4	The GS1 Identification System	16
1.5	GS1 Company Prefix Allocation	19
1.6	Allocation	20
1.7	Sunrise and sunset dates	22

1.1 The GS1 General Specifications

1.1.1 Introduction

The GS1 system originated in the United States and was established in 1973 by the Uniform Product Code Council, known until recently as the Uniform Code Council, Inc. (UCC) and since 2005 as GS1 US. The UCC originally adopted a 12-digit identification number, and the first ID numbers and barcodes in open trade were being scanned in 1974. Following the success of this U.P.C. system, the European Article Numbering Association, previously known as EAN International, but launched as GS1 in 2005, was established in 1977 to develop a compatible system for use outside North America. The EAN system was designed as a superset of the UCC system and principally used 13-digit numbers. As a consequence of using certain barcodes and data structures, the GS1 system has expanded.

The GS1 system provides for the use of unambiguous numbers to identify goods, services, assets, and locations worldwide. These numbers can be represented in barcodes to enable their electronic reading wherever required in business processes. The system is designed to overcome the limitations of using company, organisation, or sector specific coding systems, and to make trading much more efficient and responsive to customers.

These identification numbers are also used in Electronic Data Interchange (EDI), XML electronic messaging, Global Data Synchronisation (GDSN), and GS1 Network Systems. This document provides information about syntax, assignment, allocation and Automatic Data Capture (ADC) standards for GS1 identification numbers.

In addition to providing unique identification numbers, the GS1 system provides for supplementary information, such as best before dates, serial numbers, and batch numbers. Changes take place only after wide consultation and are subject to a significant migration period.

By following the principles and design of the GS1 system, users can design applications to process GS1 system data automatically. The system logic guarantees that data captured from GS1 endorsed barcodes produces unambiguous electronic messages, and processing can be fully pre-programmed.

The GS1 system is designed for use in any industry or trade sector, and any changes to the system are introduced so as not to negatively affect current users.

In February 2005, GS1 was officially launched as the successor to the organisations previously known as EAN and UCC. This document is the concise definition and explanation of the use of the GS1 system standards within Automatic Identification and Data Capture (AIDC) technologies, and supersedes all previous AIDC technical documents provided and/or published by GS1 or its predecessor organisations. The document takes immediate effect as the agreed GS1 foundational standards including Application, Identification, and Data Carrier components and principles. Every organisation using GS1 system standards is requested to conform fully to the *GS1 General Specifications*.

1.1.2 Who should read these specifications

The primary audiences of the *GS1 General Specifications* are GS1 Member Organisations and technically oriented users and suppliers.

These specifications provide a global reference document covering all technical aspects of the GS1 system. Their primary objective is to define the international standard upon which individual GS1 Member Organisations can develop user documentation. They are maintained in English and translated into local language by GS1 Member Organisations.

1.1.3 Foundational standard

These *GS1 General Specifications* are used as a foundation for other GS1 standards and services such as:

- GEPIR
- GDSN and GS1 Source.
- GS1 EDI (Electronic Data Interchange), including the GS1 EANCOM® and GS1 XML standards.

- GS1 EPCIS

The definitions in the *GS1 General Specifications* are the basis for the [GS1 glossary](#).

1.1.4 Maintenance responsibility and management

The GS1 Global Standards Management Process (GSMP) is the mechanism to approve the adoption of additions and changes to the *GS1 General Specifications*. The process is fully defined in the [Global Standards Management Process Manual](#).

1.1.5 The Barcodes & Identification Technical Group (BCID TG)

The Barcodes & Identification Technical Group (BCID TG) provides advice and guidance from the solution provider community regarding practical implementation issues and technical applications. In addition, BCID TG provides expertise for testing and trial implementations.

1.2 GS1 system principles

The GS1 system embodies an open architecture approach. It has been carefully designed for modular expansion with minimal disruption to existing applications. Enterprise Resource Planning (ERP) and other supply chain application software drive implementation of the system. New user driven applications can be expected, and this document will be updated accordingly.

The maintenance of these specifications will be the responsibility of GS1 and will be in line with the [GS1 Architecture Principles](#).

1.3 Identification system policies

The GS1 identification system provides the world a globally unique and unambiguous identification system for physical entities, parties, and relationships exchanged in the supply chain. The policies that follow apply to all sectors making use of the GS1 Company Prefix in association with GS1 keys and the Application Identification System. These policies provide for the long term integrity of the GS1 identification system so vital to the global supply chain.

1.3.1 Mandatory identifiers

All GS1 standards shall incorporate GS1 identification standards as mandatory identifiers exclusive of all other mandatory identifiers.

1.3.2 Non-GS1 identifiers

Non-GS1 identifiers may only be used with GS1 standards as additional identifiers (not alternates). Implementations using non-GS1 identifiers as primary identifiers are not compliant with GS1 standards.

1.3.3 GS1 Company Prefix

The GS1 Company Prefix is used exclusively within GS1 identification standards that may be expressed in GS1 approved barcode applications, in GS1 EDI messages, for global data synchronisation, network registration, and in EPC Tags within the header values reserved for the GS1 system. See section [1.4](#) for further details on the GS1 Company Prefix allocation.

1.3.4 Carrier independence

GS1 identification keys are defined and utilised per GS1 definitions independent of data carrier (e.g., barcode, radio frequency identification (RFID), business message).

1.3.5 GS1 business messages

GS1 business messages or GS1 standards-based applications use GS1 identification keys for identification exclusive of GS1 data carrier features. Examples of data carrier features include use of:

- Modulo 103 GS1-128 symbol check character to secure data capture.
- Function 1 Symbol Character (FNC1) in the second position of GS1-128 barcode or an Electronic Product Code (EPC) header value to discriminate between GS1 data content and data carrier overhead.
- Separator characters or EPC parsing values to parse a decoded data string into significant data parts.

 **Exception:** If an EPC user is using GS1 system and non-GS1 system headers to support an application, this policy does not apply, and advice should be sought on the use of EPC headers to provide uniqueness among multiple numbering systems.

1.4 The GS1 Identification System

1.4.1 Global, open versus restricted

1.4.1.1 Global, open numbers (unrestricted distribution)

Global, Open is an identification number used in unrestricted distribution which signifies that such system data may be applied on goods to be processed anywhere in the world without restraint as to such things as country, company, and industry.

1.4.1.2 Restricted Circulation Numbers

Restricted Circulation Numbers (RCN) are GS1 identification numbers used for special applications in restricted environments, defined by the local GS1 Member Organisation (e.g., restricted within a country, company, or industry). They are allocated by GS1 for either internal use by companies or to GS1 Member Organisations for assignment based on business needs in their country (e.g., variable measure trade item identification, coupons).

- RCN-12 is a 12-digit Restricted Circulation Number
- RCN-13 is a 13-digit Restricted Circulation Number
- RCN-8 is an 8-digit Restricted Circulation Number

1.4.2 GS1 Prefix

The GS1 Prefix is a unique string of two or more digits, issued by the GS1 Global Office, and allocated to GS1 Member Organisations to issue GS1 Company Prefixes or allocated to other specific areas listed in figure 1.4.2-1. The main purpose of the GS1 Prefix is to allow decentralisation of the administration of identification numbers. GS1 Prefix ranges are shown in figure 1.4.2-1.

 **Note:** As the GS1 Prefix varies in length, the issuance of a GS1 Prefix excludes all longer strings that start with the same digits from being issued as GS1 Prefixes.

Figure 1.4.2-1. Synopsis of GS1 Prefix ranges

GS1 Prefix range	Significance
000000	Used to issue GS1 Company Prefixes from which U.P.C. Company Prefixes can be derived.
000001 - 000009	Unused to avoid collision with GTIN-8
00001 - 00009 0001 - 0009 001 - 019	Used to issue GS1 Company Prefixes from which U.P.C. Company Prefixes can be derived.

GS1 Prefix range	Significance
02	Used to issue GS1 restricted circulation numbers within a geographic region
03	Used to issue GS1 Company Prefixes from which U.P.C. Company Prefixes can be derived.
04	Used to issue GS1 restricted circulation numbers within a company
05	GS1 US reserved for future use
06 – 09	Used to issue GS1 Company Prefixes from which U.P.C. Company Prefixes can be derived.
10 – 19	Used to issue GS1 Company Prefixes
20 – 29	Used to issue GS1 restricted circulation number within a geographic region
300 – 950	Used to issue GS1 Company Prefixes
951	Used to issue General Manager Numbers for the EPC General Identifier (GID) scheme as defined by the <i>EPC Tag Data Standard</i> ¹
952 – 976	Used to issue GS1 Company Prefixes
977	Allocated to ISSN International Centre for serial publications
978 – 979	Allocated to International ISBN Agency for books, portion of 979 sub-allocated to International ISMN Agency for music
980	Used to issue GS1 identification of refund receipts
981-984	Used to issue GS1 coupon identification for common currency areas
985 – 989	Reserved for future GS1 coupon identification
99	Used to issue GS1 coupon identification

1.4.3 GS1-8 Prefix

The GS1-8 Prefix is a unique string of three digits issued by GS1 Global Office and allocated to GS1 Member Organisations to issue GTIN-8s or allocated to create RCN-8s. GS1-8 Prefixes are shown in figure 1.4.3-1.

Figure 1.4.3-1. Synopsis of GS1-8 Prefixes

GS1-8 Prefixes	Significance
000 – 099	Used to issue GS1 restricted circulation number within a company
100 – 199	Used to issue GTIN-8s
200 - 299	Used to issue GS1 restricted circulation number within a company
300 - 976	Used to issue GTIN-8s
977 - 999	Reserved for future use

1.4.4 GS1 Company Prefix

A GS1 Company Prefix is a unique string of four to twelve digits used to issue GS1 identification keys. The first digits are a valid GS1 Prefix and the length must be at least one longer than the length of the GS1 Prefix. The GS1 Company Prefix is issued by a GS1 Member Organisation or by GS1 Global Office, is based on a GS1 Prefix allocated to the issuer, and is allocated either to a GS1 Member or to the issuer itself (e.g. for issuing individual identification keys).

A GS1 Company Prefix starting with a zero ('0') is used to generate GTIN-12s (as well as the other GS1 Keys). A GS1 Company prefix starting with a digit other than ('0') is used to generate GTIN-13s (as well as the other GS1 Keys).



Note: As the GS1 Company Prefix varies in length, the issuance of a GS1 Company Prefix excludes all longer strings that start with the same digits from being issued as GS1 Company Prefixes.

¹ <http://www.gs1.org/epc/tag-data-standard>

1.4.5 U.P.C. Prefix

A U.P.C. Prefix is derived from a GS1 Prefix that starts with zero ('0') by removing that leading zero. A U.P.C. Prefix is:

- used to issue U.P.C. Company Prefixes;
- reserved for Restricted Circulation Numbers; or
- reserved for special functions.

U.P.C. Prefix ranges are shown in figure 1.4.5-1.

Figure 1.4.5-1. Synopsis of U.P.C. Prefix ranges

GS1 Prefix range	U.P.C. Prefix range	Significance
000000	00000	Used to issue U.P.C. Company Prefixes
000001 - 000009	N/A	Unused to avoid collision with GTIN-8
00001 - 01999	0001 - 1999	Used to issue U.P.C. Company Prefixes
02	2	Used to issue GS1 Variable Measure Trade Item identification for restricted distribution
03	3	Used to issue U.P.C. Company Prefixes, reserved for alignment with FDA Labeler Code
04	4	Used to issue GS1 restricted circulation numbers within a company
05	5	Reserved for future use
06 - 09	6 - 9	Used to issue U.P.C. Company Prefixes

1.4.6 U.P.C. Company Prefix

A U.P.C. Company Prefix is derived from a GS1 Company Prefix that starts with zero ('0') by removing that leading zero. A U.P.C. Company Prefix SHALL only be used to construct 12-digit trade item identifiers; see section 2 for details.

When a leading zero is added to a U.P.C. Company Prefix it becomes a GS1 Company Prefix that may be used to issue all other GS1 identification keys.

- ✓ **Note:** For example, the 6-digit U.P.C. Company Prefix 614141 is derived from the 7-digit GS1 Company Prefix 0614141.

1.4.7 GS1 Identification Key

A GS1 Identification Key is a unique identifier for a class of objects (e.g. trade items) or an instance of an object (e.g. logistic unit).

The type of the GS1 Identification Key is declared implicitly or explicitly by the data carrier or electronic message in which the key is used.

- ✓ **Note:** For example:
 - in a bar code, the type is declared by the preceding GS1 Application Identifier (AI);
 - in the case of EAN/UPC and ITF-14 symbologies the AI (01) is implied;
 - in electronic communication (EDI messages, EPCIS, semantic tags, etc.), the type is declared by the underlying schema or specification.

The type defines the syntax (character set and structure) of the value. At minimum, the GS1 Identification Key value contains one of the following:

- a GS1 Prefix;
- a GS1-8 Prefix (only for GTIN-8);
- a GS1 Company Prefix;

- a U.P.C. Prefix; or
- a U.P.C. Company Prefix (only for GTIN-12).

1.4.8 Character set

The GS1 Identification System supports three character sets; the specific character set depends on the identification key type. The three character sets are:

1. digit characters ('0' to '9');
2. characters from the ISO/IEC 646 Table 1 – Unique graphic character allocations², referred to within this standard as GS1 AI encodable character set 82 (see figure 7.11-1); and
3. digit characters ('0' to '9'), upper case alphabetic characters ('A' to 'Z'), and three special characters ('#', '-', and '/'), referred to within this standard as GS1 AI encodable character set 39 (see figure 7.11-2).

Regardless of the identification key type, the GS1 Prefix and (if applicable) the GS1 Company Prefix within any identifier use only the digit characters. Some identification key types that have a serial component also support different characters sets for the serial component than for the portion that precedes it.

GS1 identification key type	Character set
Global Trade Item Number (GTIN)	Digit characters
Global Location Number (GLN)	Digit characters
Serial Shipping Container Code (SSCC)	Digit characters
Global Returnable Asset Identifier (GRAI)	Digit characters (before serial component) GS1 AI encodable character set 82 (serial component)
Global Individual Asset Identifier (GIAI)	GS1 AI encodable character set 82
Global Service Relation Number (GSRN)	Digit characters
Global Document Type Identifier (GDTI)	Digit characters (before serial component) GS1 AI encodable character set 82 (serial component)
Global Identification Number for Consignment (GINC)	GS1 AI encodable character set 82
Global Shipment Identification Number (GSIN)	Digit characters
Global Coupon Number (GCN)	Digit characters
Component/Part Identifier (CPID)	GS1 AI encodable character set 39

As every identifier in the GS1 Identification System is a string, even when it is composed only of digit characters, all characters including leading zeroes are significant.

1.5 GS1 Company Prefix Allocation

A GS1 Company Prefix gives access to all the applications using GS1 system identification standards.

The GS1 Company Prefix may not be sold, leased, or given, in whole or in part, for use by any other company. This restriction applies to all GS1 identification keys even those which are constructed without a GS1 Company Prefix. This requirement applies to GS1 identification keys which have been assigned individually by a GS1 Member Organisation to an individual user company.

As the GS1 Company Prefix varies in length, the issuance of a GS1 Company Prefix excludes all longer strings that start with the same digits from being issued as GS1 Company Prefixes. Note that the *GS1 EPC Tag Data Standard* supports only GS1 Company Prefixes between six and twelve digits in length (inclusive), a four- or five-digit GS1 Company Prefix SHALL be treated as a block of consecutive six-digit values for the purposes of RFID tag encoding and EPC URI generation.

² While the ISO/IEC 646:1991 specification is not publicly available, the 6th edition of ECMA-6 corresponds to it and is available at <http://www.ecma-international.org/publications/files/ECMA-ST/Ecma-006.pdf>.

See section [1.6](#) for additional guidelines that apply when a company changes legal status as a result of an acquisition, merger, partial purchase, split, or “spin-off.”

A GS1 Company Prefix assigned to a member of any GS1 Member Organisation entitles that member to create any of the GS1 identification keys:

- Global Trade Item Number (GTIN).
- Global Location Number (GLN).
- Serial Shipping Container Code (SSCC).
- Global Returnable Asset Identifier (GRAI).
- Global Individual Asset Identifier (GIAI).
- Global Service Relation Number (GSRN).
- Global Document Type Identifier (GDTI).
- Global Shipment Identification Number (GSIN).
- Global Identification Number for Consignment (GINC).
- Global Coupon Number (GCN).
- Component / Part Identifier (CPID).

1.6 Allocation

GS1 Member Organisations licence GS1 Company Prefixes and in some cases also licence individual GS1 identification keys (e.g. GTIN and GLNs) to companies.

A company, when licensing a GS1 Company Prefix, has access to all applications using the GS1 system of identification (e.g. logistic unit, service or asset identification). An individually licenced GS1 identification key, generally speaking, provides limited access to the GS1 system.

Regardless of the way the GS1 number has been issued by the GS1 Member Organisation, the normal requirements on the reuse of GS1 identification keys apply to all organisations at all times.

Additional guidelines in the following sections apply when a company changes legal status as a result of an acquisition, merger, partial purchase, split, or “spin-off.”

GS1 Member Organisations may adapt the following guidelines if the law of the country makes it absolutely necessary.

Companies SHOULD notify their GS1 Member Organisation of any legal status change within one year of that change to facilitate a smooth transition.

1.6.1 Acquisitions and mergers

If a company is being acquired by or merged with another company and has stock on hand, the stock's existing Global Trade Item Numbers (GTINs) should be kept. Products that are produced after the acquisition or merger may keep the GTIN allocated before the acquisition if the acquiring company maintains the licence with the GS1 Member Organisation to use the applicable GS1 Company Prefix or keys.

1.6.1.1 GS1 identification keys transferred to an acquiring company

An acquisition or merger often implies that a company has taken over another company and has assumed responsibility for the acquired company's GS1 Company Prefixes and any individually assigned GS1 identification keys. For example, products that the acquired company identified using its GS1 Company Prefix or individually assigned GTINs can still be produced using the same keys after the merger, since the acquiring company now has the licence to use the acquired company's GS1 Company Prefix(es) and GS1 identification keys. If it so desires, the acquiring company can also choose to identify the products using their own GS1 Company Prefix.

-  **Note:** A company should be careful when centralising the allocation of all numbers under one GS1 Company Prefix, for example resulting in a change of the GTIN of existing products, which are otherwise unchanged. Centralising the allocation of all numbers under a single GS1 Company Prefix should be an exception, as it may result in additional work and data file maintenance for customers.

The importance of ensuring trading partners are informed of any changes in a timely manner cannot be overemphasised.

1.6.1.2 GS1 identification keys not transferred to acquiring company

If a company acquires a division of a company, but its GS1 Company Prefixes continue to be used in other divisions not acquired, then the acquiring company must change the Global Trade Item Numbers (GTINs) and Global Location Numbers (GLNs) for the acquired division within one year.

-  **Note:** The rules concerning the use of the seller's GTINs and other GS1 identification keys should be taken into consideration when drawing up the purchase contract.

At the earliest opportunity, the acquiring company SHOULD phase-in new numbers from its own range of numbers for items whose brand name it has acquired. The acquiring company will be able to do this, for example, when packaging is redesigned or reprinted.

If a company sells an asset to another company, then the asset identifier SHOULD ideally be replaced by another Global Individual Asset Identifier (GIAI) or Global Returnable Asset Identifier (GRAI) within one year or be removed from the physical item.

During a sale of division or asset and for four years following the selling company must not reallocate the original numbers to other items.

-  **Important:** See section 4 for any special GTIN reuse rules that may apply.

1.6.2 Split or spin-off

When a company splits into two or more separate companies it is necessary for each GS1 Company Prefix of the original company to be transferred to only one of the new companies. Individually assigned keys also need to be transferred to only one of the new companies. If a company is left without a GS1 Company Prefix or individually assigned keys and has a requirement to identify products, locations, or assets etc., it will need to apply to a GS1 Member Organisation to obtain a new GS1 Company Prefix or individual key as appropriate.

The decision about which of the new companies should take the original GS1 Company Prefixes should be made in such a way as to minimise the impact on existing GS1 identification keys, in particular existing Global Trade Item Numbers (GTINs). The decision should be part of the legal arrangements of the new companies.

It is not necessary for existing stocks of items to be renumbered. However, when any of the split or spin-off companies has trade items that are numbered with a GS1 Company Prefix that it no longer holds, the company SHOULD renumber those items using its own GS1 Company Prefix when new labelling or packaging is produced. Customers should be notified well in advance of the changes.

Split or spin-off companies that retain a GS1 Company Prefix must keep a record of the GTINs created that have been allocated to items they no longer own. They must not reuse these GTINs for a period of at least four years after the company that split away last supplied goods identified by those GTINs. Therefore, the company that did not retain the GS1 Company Prefix has to keep the company that now maintains it informed of the dates on which goods were last supplied using that GS1 Company Prefix or to guarantee a date by which the number change will be made.

-  **Important:** See section 4 for any special GTIN reuse rules that may apply.

1.7 Sunrise and sunset dates

Expansion of both the breadth and reach of the GS1 system requires the introduction of new data carrier technologies and messaging techniques. While these are potentially disruptive, their use in GS1 Global, Open standards requires an agreed date at which they are globally accepted for use. This date is referred to as a Sunrise date. Its use is accompanied by associated rules that may be unique to the circumstances. A Sunrise date is agreed by user/members and approved by the GS1 Management Board.

Conversely, as a data carrier or messaging standard is no longer cost effective as determined by users and approved by the GS1 Management Board, it may be declared obsolete and removed from the *GS1 General Specifications*. This is termed the Sunset date. It is accompanied by associated rules that may be unique to the circumstances.

2 Application identification

2.1	Trade items	24
2.2	Logistic units.....	74
2.3	Assets	78
2.4	Locations and parties	82
2.5	Service relationships.....	89
2.6	Special applications	93
2.7	Summary of applications and operative scanning environments for GS1 system symbols.....	124

2.1 Trade items

2.1.1 Introduction

A trade item is any item (product or service) upon which there is a need to retrieve predefined information and that may be priced, or ordered, or invoiced at any point in any supply chain. This definition covers services and products, from raw materials through to end user products, all of which may have predefined characteristics.

The identification and marking of trade items enables the automation of the point-of-sale (through Price Look Up (PLU) files), of goods receiving, inventory management, automatic re-ordering, sales analysis, and a wide range of other business applications.

If the item is of variable measure, the respective measure or price information will often be of critical importance to business applications. Attributes relating to trade items (e.g., dates, lot number) are also available as standardised element strings.

Each trade item that is different from another in design and/or content is allocated a unique identification number, which remains the same as long as it is traded. The same identification number is given to all trade items sharing key characteristics. Such numbers must be treated in their entirety throughout the supply chain.

The serialised identification of trade items, which enables total connectivity of information and communication systems, is achieved through the use of GS1 Application Identifier AI (01) GTIN and AI (21) serial number.

Different standard solutions apply depending on the nature of the item and the scope of the user's applications. The following sections determine the identification and symbol marking rules applicable to a particular trade item.

2.1.1.1 Physical or non-physical trade items

Non-physical trade items are usually called services. Services may be identified with a unique GS1 identification key for use in open trade applications or in restricted distribution environments.

2.1.1.2 Open or restricted distribution

The main benefit of the GS1 system for trade items is that it provides a unique and unambiguous identification number for every trade item, which is applicable worldwide in open environments. In addition, the system provides for other number series that may be exclusively used for restricted distribution (e.g., national use, company internal use). Restricted distribution identification numbers are available to GS1 Member Organisations' members to help them develop solutions applicable within their territory.

2.1.1.3 Fixed or variable measure

Fixed measure trade items are those that are always produced in the same version and composition (e.g., type, size, weight, contents, and design). Like a fixed measure trade item, a variable measure trade item is an entity with predefined characteristics, such as the nature of the product or its contents. Unlike a fixed measure trade item, a variable measure trade item has at least one characteristic that varies whilst other characteristics of the trade item remain the same. The variable characteristic may be weight, dimension, number of items contained, or volume information. The complete identification of a variable measure trade item consists of both an identification number and information about the variable data.

2.1.1.4 General retail consumer trade item, regulated healthcare retail consumer trade item or non-retail trade item

Scanning at the point-of-sale (POS) is a major application of the GS1 system, and trade items that are intended to cross a point-of-sale are subject to specific rules. Scanning of trade items are broken into three groups based on the application and sector.

- **General retail consumer trade items** use omnidirectional linear barcodes that are read by high-volume omnidirectional retail POS scanners or linear hand held scanners. This scanning environment cannot read 2D matrix symbols.
- **Regulated healthcare retail consumer trade items** require a high capacity symbology, such as 2D matrix symbols, but these cannot be deployed for high-volume omnidirectional retail POS. Regulated healthcare retail consumer trade items marked with 2D matrix symbols are intended to be read in lower-volume retail scenarios or hospital pharmacies or in high volume applications such as distribution centres.
- **Non-retail trade items** are any trade item that does not cross retail POS. Commonly, these trade items will appear in mixed scanning environments (laser, image based, etc.) depending on the application and industry sector. Typical examples include trade item groupings, direct part marked items, etc.

2.1.1.5 Books and serial publications

Published material (newspapers, magazines, and books) requires special consideration due to the following factors:

- A solution for published material should address the requirement to process returns (sorting and counting) to wholesalers and publishers. This implies the reading of a supplementary number that is not required for item identification.
- The international systems, ISSN, ISBN and ISMN, already handle the numbering of publications and books.

2.1.1.6 Single item or trade item grouping

A trade item may be a single, non-breakable unit or a predefined grouping of a series of single items. Such trade item groupings may be present in a wide variety of physical forms, such as a fibreboard case, a covered or banded pallet, a film wrapped tray, or a crate with bottles. Trade items consisting of a single unit are identified with a Global Trade Item Number (GTIN). Trade item groupings of identical or different units, each identified with a GTIN, are identified with a separate GTIN; the individual trade item GTIN, within any grouping, SHALL remain the same. Example: trade item A has the same GTIN whether it is sold as a single unit in a case of twelve or sold as a single unit in a case of twenty-four.

2.1.1.7 Trade item assortments

Three kinds of assortments exist:

- **Predefined assortments:** An assortment that comprises a fixed count of two or more different trade items, each identified with a unique GTIN that is declared on the package. The trade items contained within the assortment may be trade items of one or more manufacturers. When an assortment contains items from multiple manufacturers the GTIN requirements for the assortment is the responsibility of the organisation that creates the assortment. Any change in the configuration of the assortment is considered a new trade item.
- **Dynamic assortments:** An assortment that comprises a fixed count of a changing assortment of two or more different retail consumer trade items, each identified with a unique GTIN. All of the retail consumer trade items and their GTINs will have been communicated to the recipient before trading takes place and are declared on the package. The recipient has accepted that the supplier may change the assortment without any prior notice.
- **Random assortments:** An assortment that comprises items that are not uniquely identified on the package and are not marked for individual sale (e.g., a bag of individually wrapped candies or colours of tooth brushes).

2.1.1.8 Regulated healthcare trade items (RHTI)

Regulated healthcare trade items (RHTI) are pharmaceutical or medical device trade items that are sold or dispensed in a controlled environment such as in a retail pharmacy, hospital pharmacy, etc.

2.1.1.8.1 Marking levels of regulated healthcare trade items

For regulated healthcare trade items (RHTI) three levels of identification have been developed:

- Minimum Level of AIDC marking.
- Enhanced Level of AIDC marking.
- Highest Level of AIDC marking.

The identification solution for each of these levels may differ between the category of “pharmaceuticals” (which includes biologics, vaccines, controlled substances, clinical trial pharmaceuticals, and therapeutic nutritional products) versus the category of “medical devices” (which includes all classes of medical devices) and may also differ by configuration or packaging level (trade items direct marked, primary packaging, secondary packaging, case/shipper, pallet, logistics unit). The standards in section [2.1.2.5](#) define the data required by packaging level and by product type. For purposes of AIDC marking the brand owner is responsible for determining the proper assignment of each particular regulated healthcare retail consumer trade item to either the pharmaceutical or medical device category in accordance with local regulatory requirements. Additionally within some use cases, or under the requirement of some regulations, certain medical devices will require direct part marking (DPM) of the AIDC data carrier. For more details on the application of DPM with medical devices see section [2.1.2.7](#).

2.1.1.8.2 National Healthcare Reimbursement Numbers

National Healthcare Reimbursement Number (NHRN) is the term for identification numbers used on pharmaceutical and/or medical devices, where required by national or regional regulatory organisations, for product registration purposes and/or for the management of reimbursement. For compliance with a national/regional regulatory or industry requirement where the GTIN will not meet the current need, the trade item SHALL be identified with GTIN and the applicable GS1 Application Identifier for NHRN.

See sections [2.1.2.4](#), [2.1.2.5](#) and [3.8.17](#) for a complete description of the structure and rules of use of the GS1 Application Identifier for NHRN.

2.1.1.9 Single trade items composed of several physical parts

Because of its physical nature, a trade item may be packed in separate physical parcels. For example, furniture equipment may be composed of several pieces (e.g., a sofa and two armchairs, which cannot be ordered or sold separately). A specific standard solution is available to identify and symbol mark each component of a trade item composed of several physical parts.

2.1.2 Fixed measure trade items – open supply chain

Fixed measure trade items are those that are always produced in the same version and composition (e.g., type, size, weight, contents, design). The identification number identifies the item unambiguously. Every trade item that is different from another in any respect is assigned a separate Global Trade Item Number (GTIN).

2.1.2.1 General retail consumer trade items scanned in general retail at POS

A general retail consumer trade item that is intended to be read at high-volume POS. The general retail consumer trade item must carry a barcode from the EAN/UPC symbology family and in limited circumstances a symbol from the GS1 DataBar® Retail POS Family (*). Therefore, these trade items support only GTIN-8, GTIN-12, or GTIN-13s.

Some point-of-sale scanning systems may be able to handle symbologies other than the EAN/UPC symbology. However, in an open environment, it is not possible to predict the type of scanner that will be used. Therefore, items that may be scanned at point-of-sale must be marked with an omnidirectional barcode. To support new applications additional GS1 approved data carriers (encoding additional data with the GTIN) may be applied with mutual agreement between trading partners. For information on how to manage multiple barcodes see section [4.15](#).

(*) In 2014 GS1 DataBar became an open symbology and all scanning environments must be able to read these symbols.

2.1.2.1.1 GTIN data string

A GTIN may be an eight, twelve, thirteen or fourteen-digit string as explained in the sections below. These strings will be unique when they incorporate a GS1 Company Prefix, U.P.C. Company Prefix or GS1-8 Prefix as required, and if they are always treated as a data string of digits plus a final check digit. The check digit is explained in section 7.9. Its verification ensures that the number is correctly composed.

Figure 2.1.2.1.1-1. Overview of GTIN formats

	GS1 Company Prefix						Item reference						Check digit	
(GTIN-13)	N ₁	N ₂	N ₃	N ₄	N ₅	N ₆	N ₇	N ₈	N ₉	N ₁₀	N ₁₁	N ₁₂	N ₁₃	
(GTIN-14)	N ₁	N ₂	N ₃	N ₄	N ₅	N ₆	N ₇	N ₈	N ₉	N ₁₀	N ₁₁	N ₁₂	N ₁₃	N ₁₄
	U.P.C. Company Prefix						Item reference						Check digit	
(GTIN-12)			N ₁	N ₂	N ₃	N ₄	N ₅	N ₆	N ₇	N ₈	N ₉	N ₁₀	N ₁₁	N ₁₂
	GS1-8 Prefix						Item reference						Check digit	
(GTIN-8)							N ₁	N ₂	N ₃	N ₄	N ₅	N ₆	N ₇	N ₈

When any of these GTINs is encoded in a data carrier that must encode a fixed-length data string of 14-digits, the GTINs less than 14-digits in length must be prefixed by leading zeroes that simply act as filler digits.

Figure 2.1.2.1.1-2. 14-digit representation of the four GTIN formats

	added zero(es)						right aligned GTIN string							
(GTIN-8)	0	0	0	0	0	0	N ₁	N ₂	N ₃	N ₄	N ₅	N ₆	N ₇	N ₈
(GTIN-12)	0	0	N ₁	N ₂	N ₃	N ₄	N ₅	N ₆	N ₇	N ₈	N ₉	N ₁₀	N ₁₁	N ₁₂
(GTIN-13)	0	N ₁	N ₂	N ₃	N ₄	N ₅	N ₆	N ₇	N ₈	N ₉	N ₁₀	N ₁₁	N ₁₂	N ₁₃
(GTIN-14)	N ₁	N ₂	N ₃	N ₄	N ₅	N ₆	N ₇	N ₈	N ₉	N ₁₀	N ₁₁	N ₁₂	N ₁₃	N ₁₄

The presence or lack of these leading zeroes does not change the GTIN concerned.

- Note:** GTINs may be stored with or without leading zeroes in the same database field, depending on the requirements of the particular application.

- Note:** A GTIN-12 may start with one, two or three leading zeros. These zeroes are meaningful since they are part of the U.P.C. Company prefix, and therefore these must be preserved when storing the GTIN-12 in a database field. For the list of U.P.C. Prefix ranges see section 1.4.

2.1.2.1.2 GTIN-12 and GTIN-13

Application description

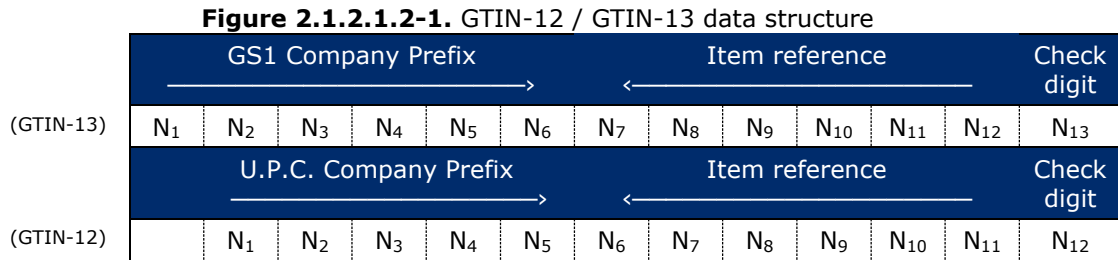

The GS1 Company Prefix is allocated by a GS1 Member Organisation to a system user. It makes the ID number unique worldwide but does not identify the origin of the item. Any valid GS1 Company Prefix, other than ones starting with a zero, may be used to issue a GTIN-13 and any valid U.P.C. Company Prefix may be used to issue a GTIN-12. The GS1 Prefixes used for this purpose can be found in section [1.4](#).

The item reference is assigned by the system user, who must observe the rules in section 4.

The check digit is explained in section [7.9](#). Its verification, carried out automatically by the barcode reader, ensures that the number is correctly composed.

GS1 key

Definition

- The GTIN-12 is the 12-digit GS1 identification key composed of a U.P.C. Company Prefix, item reference, and check digit used to identify trade items.
- The GTIN-13 is the 13-digit GS1 identification key composed of a GS1 Company Prefix, item reference, and check digit used to identify trade items.

Rules

All the GTIN rules described in section 4.

Attributes

Required

Not applicable

Optional

For all the GS1 Application Identifiers (AI) that can be used with a GTIN, see section 3.

Rules

Not applicable

Data carrier specification

Carrier choices

The data carriers for this element string are:

- UPC-A barcode (carrying a GTIN-12).
- EAN-13 barcode (carrying a GTIN-13).
- GS1 DataBar Retail POS family (carrying GTIN-12 or GTIN-13 represented in a fixed-length data string of 14 digits by adding leading zeroes) (*).

EAN-13 and UPC-A is generally referenced as a common symbology called EAN/UPC.

The system recognises this element string by the symbology identifier **JE0** and **je0** (*) and a valid GS1 Company Prefix (also see section [1.4](#)).

The data transmitted from the barcode reader means that one fixed measure trade item with a GTIN-13 or GTIN-12 has been captured.

(*) In 2014 GS1 DataBar became an open symbology and all scanning environments must be able to read these symbols.

Symbol X-dimensions, minimum symbol height, and minimum symbol quality

See section [5.5.2.7.1](#), GS1 system symbol specification table 1, and section [5.5.2.7.3](#), GS1 system specification Table 3.

Symbol placement

All the symbol placement guidelines are defined in section 6.

Unique application processing requirements

For a description of processing requirements, see section 7.

2.1.2.1.3 GTIN-12 Carried by a UPC-E barcode

Application description

Some GTIN-12s beginning with the U.P.C. Prefix 0 may be represented in a small symbol called the UPC-E barcode. The GTIN-12 is condensed into a barcode consisting of six symbol character positions. For application processing, the GTIN-12 must be transformed into its full length by the barcode reader software or by the application software. There is no six-digit UPC-E barcode. See section [7.10](#) for UPC-E barcode options.

GS1 key

Definition

The 12-digit GS1 identification key composed of a U.P.C. Company Prefix, item reference, and check digit used to identify trade items.

Rules

All the GTIN rules described in section 4.

Attributes

Required

Not applicable

Optional

Not applicable

Rules

Not applicable

Data carrier specification

Carrier choices

The UPC-E barcode is a barcode of the EAN/UPC symbology representing a GTIN-12 in six explicitly encoded digits using zero-suppression techniques.

Symbol X-dimensions, minimum symbol height, and minimum symbol quality

See section [5.5.2.7.1](#), GS1 system symbol specification table 1.

Symbol placement

All the symbol placement guidelines defined in section 6.

Unique application processing requirements

For a description of processing requirements, see section 7.

2.1.2.1.4 GTIN-8 carried by an EAN-8 barcode

Application description

The GTIN-8 is available for items whose packaging does not include enough available space to permit the use of an EAN-13 symbol. GTIN-8s are individually assigned by GS1 Member Organisations on request. Figure 2.1.2.1.4-1 shows the data structure of a GTIN-8.

Figure 2.1.2.1.4-1. GTIN-8 data structure

GS1-8 Prefix			Item reference				Check digit
N ₁	N ₂	N ₃	N ₄	N ₅	N ₆	N ₇	N ₈

The GS1-8 Prefix is a unique string of three digits issued by GS1 Global Office. See section [1.4.3](#) for the GS1-8 Prefixes used in this element string.

The item reference is assigned by the GS1 Member Organisation. The GS1 Member Organisations provide procedures for obtaining GTIN-8s.

The check digit is explained in section [7.9](#). Its verification, carried out automatically by the barcode reader, ensures that the number is correctly composed.

GS1 key

Definition

The 8-digit GS1 identification key composed of a GS1-8 Prefix, item reference, and check digit used to identify trade items.

Rules

In addition to the GTIN rules described in section 4, the following guidelines should be observed. Before deciding to use a GTIN-8 as opposed to a GTIN-13 or GTIN-12, companies, working jointly with their printer, should consider options such as:

- Whether the barcode can be reduced in size; e.g., printed at a lower X-dimension, taking into account the minimum barcode print quality requirements (see section [5.5](#)).
- Whether the label or artwork can reasonably be changed to enable the inclusion of an EAN-13 or a UPC-A barcode or a symbol from the GS1 DataBar Retail POS family.
- For example, redesigning the label and increasing the label size may be an option, especially when the existing label is small in comparison with the pack area.
- Whether a truncated barcode can be used.

 **Note:** A truncated barcode (normal length, but reduced in height) may only be used if there is absolutely no possibility of printing a full size barcode. Truncation removes the omnidirectional scanning capability. A barcode with excessive truncation will not be of any practical use. Users considering this option should consult their customers to see if an acceptable compromise can be reached.

Pack size constraints

The use of a GTIN-8 is authorised when:

- The total printable area of the product packaging is less than 80 cm², or
- The area of the largest label for the item is less than 40 cm², or
- The product is cylindrical with a diameter less than 30 mm.

Figure 2.1.2.1.4-2. GTIN-8 pack size constraints

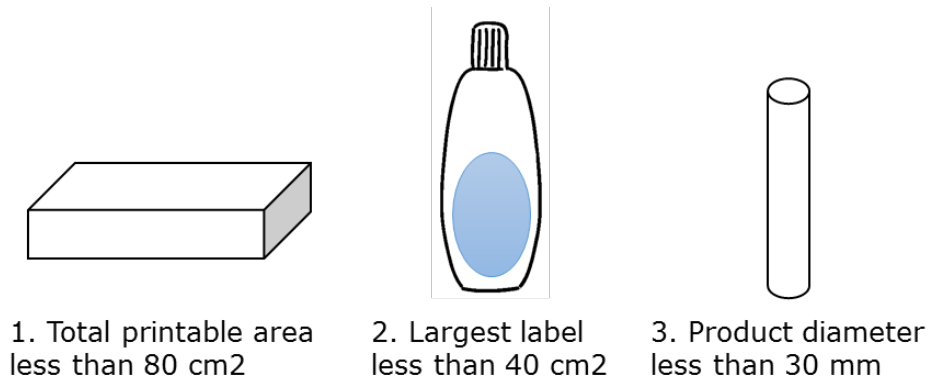

Attributes

Required

Not applicable

Optional

For all the GS1 Application Identifiers (AI) that can be used with a GTIN, see section 3.

Rules

Not applicable

Data carrier specification

Carrier choices

The data carriers for a GTIN-8 are the EAN-8 barcode or a symbol from the GS1 DataBar Retail POS family (*).

The system recognises this element string by the symbology identifier **JE4 or Je0** (*) and by N₁ not being 0 or 2. The data transmitted from the barcode reader means that one fixed measure trade item with a GTIN-8 has been captured.

(*) In 2014 GS1 DataBar became an open symbology and all scanning environments must be able to read these symbols.

Symbol X-dimensions, minimum symbol height, and minimum symbol quality

See section [5.5.2.7.1](#), GS1 system symbol specification table 1.

Symbol placement

All the symbol placement guidelines defined in section 6.

Unique application processing requirements

For a description of processing requirements, see section 7.

2.1.2.1.5 Hardcover books and paperbacks: ISBN, GTIN-13, and GTIN-12 scanned in general retail at POS

Application description

When identifying books and paperbacks a company may identify them in the same manner as any other retail trade items (see section [2.1.2.1](#)). However, the recommended option is to use the International Standard Book Number (ISBN numbering system). The GS1 Prefixes 978 and 979 (*) have been allocated to ISBN (<http://www.isbn-international.org/>), which allocates numbers from these 'Bookland' prefixes.

(*) Within GS1 Prefix 979 a subset 9790 has been allocated to the International ISMN Agency for notated music.

Note: ISBNs SHALL NOT be allocated to non-book products even if the products are related to a book (e.g., teddy bears, coffee mugs, T-shirts, etc. related to a book launch). Such non-book products SHALL be identified and barcoded in the same manner as any other retail trade item (see section [2.1.2.1](#)). A trade item grouping of identical book items would normally be identified according to section [2.1.2.6.2](#). However, an ISBN may also be used to create a 14-digit GTIN with an indicator to identify a trade item grouping of identical book items (refer to section [2.1.2.6.2](#)) provided that the publisher that issues the 14-digit GTIN is a member of a GS1 organisation or is authorised to act through an agreement between its local GS1 Member Organisation and the local organisation representing publishers.

GS1 key

Definition

The Global Trade Item Number® (GTIN) is the GS1 identification key used to identify trade items. The key comprises a GS1 Company Prefix, an item reference and a check digit.

Rules

All the GTIN rules described in section 4.

Attributes

Required

Not applicable

Optional

Some publishers may wish to communicate additional information in a barcode in order to meet their internal requirements. For example, publishers may wish to include an edition variant (e.g., unchanged reprint, price increase), which is not distinguished by the ISBN, GTIN-13, or GTIN-12. The GS1 system provides an additional two- or five-digit symbol, called an add-on symbol that can be included on the item just to the right of the main barcode.

A two-digit or five-digit serial number provides more information about a particular publication of the printed item, but it is not required for the identification of the title itself. This figure shows the format of a two-digit add-on:

Figure 2.1.2.1.5-1. Two-digit add-on format

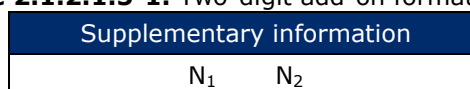

The supplementary information consists of numeric data of any structure and meaning. It is the publisher's responsibility to define the numbering scheme.

The data carrier for this element string is the two-digit add-on symbol.

The system recognises this element string by the symbology identifier]E1. The two-digit add-on symbol must be jointly used with a UPC-A, UPC-E or EAN-13 barcode. It is never scanned alone, and the data from both barcodes can be used together for processing.

This figure shows the format of a five-digit add-on:

Figure 2.1.2.1.5-2. Five-digit add-on format

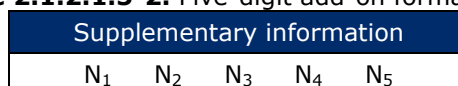

The supplementary information consists of numeric data of any structure and meaning. It is the publisher's responsibility to define the numbering scheme. The data carrier for this element string is the five-digit add-on symbol.

The system recognises this element string by the symbology identifier]E2. The five-digit add-on symbol must be jointly used with a UPC-A, UPC-E or EAN-13 barcode. It is never scanned alone, and the data from both barcodes can be used together for processing.

Rules

Add-on symbols involve the following constraints:

- They SHOULD NOT contain information that should rightly be looked up using the item’s GTIN-13 (or GTIN-12).
- The reading of the add-on symbol by the retailer's point-of-sale system is optional.
- The use of the add-on symbol is the responsibility of each publisher.

Data carrier specification

Carrier choices

Individual books and paperbacks SHOULD be marked with an EAN-13, UPC-A, or UPC-E barcode that complies with the print quality specifications applicable to all GS1 system barcodes. The EAN/UPC 2-digit or 5-digit Add-on symbols are options used with the above EAN/UPC symbols.

Groupings of identical book items and paperbacks SHOULD be marked with GS1-128 or ITF-14, see section [2.1.2.6.2 Trade item groupings of identical trade items](#).

When identifying serial publications, see section [2.1.2.1.6 Serial publications: ISSN, GTIN-13, and GTIN-12](#).

Symbol X-dimensions, minimum symbol height, and minimum symbol quality

See section [5.5.2.7.1](#), GS1 system symbol specification table 1.

Symbol placement

All the symbol placement guidelines defined in section [6.4](#).

Unique application processing requirements

For description of processing requirements, see section 7.

2.1.2.1.6 Serial publications: ISSN, GTIN-13, and GTIN-12 scanned in general retail at POS

Application description

The first and recommended option is to make use of the ISSN numbering system. The GS1 Prefix 977 is used for encoding the ISSN assigned to a particular item without its check digit.

The second option is to identify serial publications in the same manner as any other trade item: using the GTIN-13 or GTIN-12 data structure.

The third option involves using a special GS1 Company Prefix (assigned by a GS1 Member Organisation within its territory), the publication number, and the price of the publication (provided that the national legislation allows this). With this option, the price is placed in clearly defined positions and is directly usable in the country of publication. However, as soon as the item leaves the country, the price has no direct significance, and the GTIN must be interpreted in a general way without being broken down internally.

Figure 2.1.2.1.6-1. Format of the element string

GS1 Prefix	ISSN (without its check digit)	Variant	Check digit
9 7 7	N ₄ N ₅ N ₆ N ₇ N ₈ N ₉ N ₁₀	N ₁₁ N ₁₂	N ₁₃

The variant digits N₁₁ and N₁₂ may be used to express variants of the same title for issues with a different price or to identify different issues of a daily within one week. Normal title takes value 00.

GS1 key

Definition

The Global Trade Item Number (GTIN) is the GS1 identification key used to identify trade items. The key comprises a GS1 Company Prefix, an item reference and a check digit.

Rules

All the GTIN rules described in section 4.

Attributes

Required

Not applicable

Optional

Some publishers may wish to communicate additional information in a barcode in order to meet their internal requirements.

A two-digit or five-digit serial number provides more information about a particular publication of the printed item, but it is not required for the identification of the title itself.

This figure shows the format of a two-digit add-on:

Figure 2.1.2.1.6-2. Two-digit add-on format

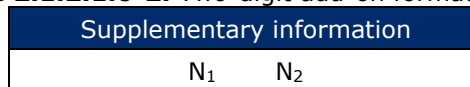

GS1 recommends the use of the following number assignment:

- Dailies (or more generally publications with several issues a week): The publications of each day of the week are considered separate trade items that must be identified with a separate identification number represented in an EAN-13, UPC-A, or UPC-E symbol. The two-digit serial number should only be used to represent the applicable week, which, together with the GTIN-13 or GTIN-12, establishes the day within the year.
- Weeklies: Number of the week (01 – 53).
- Bi-weeklies: Number of the first week of the respective period (01 – 53).
- Monthlies: Number of the month (01 – 12).
- Bi-monthlies: Number of the first month of the respective period (01 – 12).
- Quarterlies: Number of the first month of the respective period (01 – 12).
- Seasonal period: First digit = last digit of the year; second digit = 1 spring, 2 summer, 3 autumn, 4 winter.
- Bi-annual period: First digit = last digit of the year; second digit = number of the first season of the respective period.
- Annuals: First digit = last digit of the year; second digit = 5.
- Special intervals: Consecutively numbered from 01 to 99.

The serial number is carried by a two-digit add-on symbol that is placed to the right of the symbol and parallel to it. The add-on symbol must comply with the print quality specifications applicable to all GS1 system barcodes. For example, the X-dimension applied to the main barcode must also be applied to the add-on symbol.

Serial publications can also use a five-digit serial number carried by a five-digit add-on symbol. The reading of the add-on symbol at a point-of-sale is optional. The add-on symbol must not be used to encode information that should be contained within the Global Trade Item Number (GTIN). The add-on symbol provides additional information about a particular publication of a printed item, and it is the publisher’s responsibility to define the numbering scheme. This figure shows the format of a five-digit add-on:

Figure 2.1.2.1.6-3. Five-digit add-on format

Supplementary information				
N ₁	N ₂	N ₃	N ₄	N ₅

Information that can be encoded in the five-digit add-on symbol includes the actual date of issue, in order to differentiate between successive issues.

The five-digit add-on symbol is placed to the right of the main barcode and parallel to it. The add-on symbol must comply with the print quality specifications applicable to all GS1 system barcodes. For example, the X-dimension applied to the main symbol also must be applied to the add-on symbol.

Rules

When using a five-digit add-on symbol, a two-digit add-on symbol cannot also be used.

Data carrier specification

Carrier choices

Serial Publications SHOULD be marked with an EAN-13, UPC-A, or UPC-E barcode that complies with the print quality specifications applicable to all GS1 system barcodes. The EAN/UPC 2-digit or 5-digit Add-on symbols are options used with the above EAN/UPC symbols.

Symbol X-dimensions, minimum symbol height, and minimum symbol quality

See section [5.5.2.7.1](#), GS1 system symbol specification table 1.

Symbol placement

All the symbol placement guidelines defined in section [6.4](#).

Unique application processing requirements

For a description of processing requirements, see section 7.

2.1.2.2 Fresh food trade items scanned in general retail at POS

Application description

Fresh foods includes product categories such as: fruits, vegetables, meat, seafood, bakery and ready-to-serve food such as cheeses, cold cooked or cured meats, and salad, etc.

In this application there are different scenarios:

- Loose produce: Picked as an each – sold as an each.
- Fresh food: Pre-packed with same weight or count.

Loose produce trade items sold as an each

Loose produce are fruits and vegetables which are delivered to the store loose, in boxes or cases. Loose produce can then be displayed on the shelf allowing for the consumer to pick the product quantities needed. If loose produce has been defined to be sold by the each then they are treated in the same way as the retailer sells a can of soup or beans.

From a brand owner's perspective, the trade item is a fixed measure trade item identified with a GTIN with no additional attributes necessary to complete transaction.

Pre-packed fresh food trade items

When fresh foods trade items, whether loose produce or cut from a bulk item or cut into pieces are pre-packaged as a fixed measure trade item then the trade item is also treated like any other fixed measure trade item identified with a GTIN with no additional attributes necessary to complete transaction.

GS1 key

Definition

- The GTIN-8 is the 8-digit GS1 identification key composed of a GS1-8 Prefix, item reference, and check digit used to identify trade items.
- The GTIN-12 is the 12-digit GS1 identification key composed of a U.P.C. Company Prefix, item reference, and check digit used to identify trade items.
- The GTIN-13 is the 13-digit GS1 identification key composed of a GS1 Company Prefix, item reference, and check digit used to identify trade items.

Rules

All the GTIN rules described in section 4

For human readable interpretation rules see section [4.14](#).

Attributes

Required

Not applicable

Optional

For all the GS1 Application Identifiers (AI) that can be used with a GTIN, see section 3.

Rules

Not applicable.

Data carrier specification

Carrier choices

The data carriers for this element string are:

- UPC-A barcode (carrying a GTIN-12).
- EAN-8 barcode (carrying GTIN-8).
- EAN-13 barcode (carrying a GTIN-13).
- GS1 DataBar Retail POS family (carrying GTIN-12 or GTIN-13) (*).

EAN-13 and UPC-A is generally referenced as a common symbology called EAN/UPC.

The system recognises this element string by the symbology identifier **JE0** and **je0** (*) and the GS1 Prefixes starting with 000 to 019, 030 to 039, 060 to 099, 100 to 139, 300 to 969, or 977 to 979.

The data transmitted from the barcode reader means that one fixed measure trade item with a GTIN-13 or GTIN-12 has been captured.

(*) In 2014 GS1 DataBar became an open symbology and all scanning environments must be able to read these symbols.

The GS1 DataBar symbols encode a 14-digit numeric string. When encoding GTIN-8, GTIN-12 or GTIN-13 in GS1 DataBar symbols zero-fill with six, two, or one zeros to the left of the GTIN.

Symbol X-dimensions, minimum symbol height, and minimum symbol quality

See section [5.5.2.7.1](#), GS1 system symbol specification table 1.

Symbol placement

There are no specified rules for symbol placement on loose produce scanned at POS.

Unique application processing requirements

Not applicable

2.1.2.3 Trade items intended for general distribution and POS

Trade items intended for general distribution and point-of-sale scanning must carry a barcode of the EAN/UPC or GS1 DataBar symbology. Therefore, these trade items support GTIN-12s or GTIN-13s (see section [2.1.2.1.2](#)). To support new applications additional GS1 approved data carriers (encoding additional data with the GTIN) may be applied with mutual agreement between trading partners. For information on how to manage multiple barcodes see section [4.15](#).

2.1.2.4 Healthcare primary packaging (non-retail trade items)

Application description

Healthcare primary packaging trade items are pharmaceutical and medical products or their packages presented to support the point-of-care (direct consumption based on right product, dose, and route of administration). Because the product is never scanned at retail POS the use of symbologies beyond EAN/UPC and the use of GTIN-14 data structure is permitted. These products, which may be packaged in a sterile packaging system or in a non-sterile packaging system, are only marked when the package is intended for dispensing to the consumer in a hospital or equivalent facility (e.g. field hospital, nursing home, home healthcare). See section [4.15.1](#) (Multiple barcode management practices for consumer trade items – all sectors), then [4.15.3](#) (Multiple barcode management practices for healthcare) if the product is intended for scanning at general retail and also must meet regulatory requirements for this application section based on multiple market use.

If an item is a Regulated healthcare retail consumer trade item and also a non-retail trade item then the barcode marking for Regulated healthcare retail consumer trade items is required at a minimum.

GS1 key

Definition

- The GTIN-8 is the 8-digit GS1 identification key composed of a GS1-8 Prefix, item reference, and check digit used to identify trade items.
- The GTIN-12 is the 12-digit GS1 identification key composed of a U.P.C. Company Prefix, item reference, and check digit used to identify trade items.
- The GTIN-13 is the 13-digit GS1 identification key composed of a GS1 Company Prefix, item reference, and check digit used to identify trade items.
- The GTIN-14 is the 14-digit GS1 identification key composed of an indicator digit (1-9), GS1 Company Prefix, item reference, and check digit used to identify trade items.

Rules

All the GTIN rules described in section 4.

If the regulated healthcare retail consumer trade item to be marked on the primary packaging does not also have secondary packaging, then the primary packaging markings in this section do not apply and are replaced by the required markings in the secondary packaging section ([2.1.2.5](#)).

Example: a bottle of 50 pharmaceutical tablets (the primary package) is not enclosed into a carton (which would represent the secondary packaging). In this instance, the secondary packaging markings are required on the primary packaging level.

If the required AIDC marks are placed directly on the part, then those AIDC marks (e.g., barcode, human readable interpretation) satisfy the requirements for primary package marking. If those marks are functional (scannable) through the primary packaging, then no additional AIDC marks are required on the primary package.

If the product to be marked has primary packaging that is a blister pack containing several individual pharmaceutical items, for instance a blister pack of 12 pills or tablets, the following rules apply:

- GTIN is the only required mark.
- In addition to the GTIN rules described in section 4, see section [2.1.2.1.4](#) for rules on deploying GTIN-8.

Attributes

Required

Figure 2.1.2.4-1. Overview of required attributes

AIDC marking level for regulated healthcare trade items	Key	Batch/lot number - AI (10)	Expiration date - AI (17)	Serial number - AI (21)	Other
Minimum (pharmaceutical only)	GTIN-8, GTIN-12, GTIN-13, or GTIN-14	No	No	No	None
Enhanced (med device only)	GTIN-8, GTIN-12, GTIN-13, or GTIN-14	Yes	Yes	No	None
Highest – pharmaceutical brand owner AIDC marking	GTIN-8, GTIN-12, GTIN-13, or GTIN-14	No	No	No	No
Highest – medical device - brand owner AIDC marking	GTIN-8, GTIN-12, GTIN-13, or GTIN-14	Yes	Yes	Yes	Active potency, AI (7004), for kits with pharmaceuticals
Highest – hospital AIDC marking of pharmaceutical	GTIN-8, GTIN -12, GTIN -13, or GTIN -14	No	Yes, Expiration date and time, AI (7003), if needed for short life items	Yes	None
Highest – hospital AIDC marking of certain medical devices (see section 2.1.2.7)	GRAI, AI (8003), or GIAI, AI (8004), is optional if GTIN, AI (01), + serial number, AI (21), is not marked on the product.	No	No	GRAI, AI (8003), or GIAI, AI (8004), is optional if GTIN, AI (01), + serial number, AI (21), is not marked on the product.	

To manage healthcare data requirements within GS1 EPC/RFID tags, see section [3.11](#) and the most recent version of the *EPC Tag Data Standard*.

Optional

For compliance with a national/regional regulatory or industry requirement where the GTIN will not meet the need, a regulated healthcare trade item may be identified with GTIN and AI (710), AI (711), AI (712), and AI (713) National Healthcare Reimbursement Number. See section [3.8.17](#) for details on the use of AI (710), AI (711), AI (712), and AI (713).

Rules

All the GTIN rules described in section 4.

National Healthcare Reimbursement Number AI (710), AI (711), AI (712), and AI (713) must always be used with the GTIN.

Human readable interpretation

For human readable interpretation rules see section [4.14](#). For HRI rules specific to regulated healthcare retail consumer trade items, see section [4.14.1](#).

Data carrier specification

Carrier choices

Figure 2.1.2.4-2. Carrier choices

<p>Preferred option(s) (this is the long-term direction for AIDC marking)</p>	<p>GS1 DataMatrix symbology GS1-128 symbology GS1 DataBar symbology</p> <p>NOTE: If a product package serves multiple markets and in one market the specifications in section 2.1.2.1 apply, then the specification for 2.1.2.1 must be followed for encoding GTIN (at a minimum) and the rules for use of multiple symbols in section 5.5 apply.</p>
<p>Option in addition to the barcode</p>	<p>EPC/RFID tag. GS1 expects the barcode as the minimum requirement for packaging however EPC RFID is an approved AIDC carrier which can be deployed in addition to the barcode.</p>
<p>Other acceptable options (GS1 strongly supports existing options for symbol marking as a guiding principle and therefore supports all previous AIDC marking specifications)</p>	<p>The following symbols have been permitted by GS1 and therefore could appear on some existing packages. For that reason, GS1 does not want to preclude them as an option, particularly where GTIN without additional data (Minimum ID) is required. With that said, symbols that allow all the data to be concatenated into one symbol are the preferred option.</p> <p>EAN/UPC symbology family (UPC-A, UPC-E, EAN-8 and EAN-13) may be used to encode the GTIN-8, GTIN-12 or GTIN-13 Identification. ITF-14 symbols may be used where printing conditions require the application of a less demanding symbology. It may not be used when attribute information is required. ITF-14 symbols can encode the GTIN-8, GTIN-12, GTIN-13, or GTIN-14 of the item. It is not used to encode attribute information.</p> <p>GS1 Composite Component is also used in combination with linear symbols by GS1 and therefore remains a legitimate option however, GS1 DataMatrix is preferred based on its ability to encode all information in one symbol and do so efficiently in terms of print speed and panel size.</p>

Symbol X-dimensions, minimum symbol height, and minimum symbol quality

See section [5.5.2.7.6](#) symbol specification table 6

Symbol placement

All the symbol placement guidelines defined in section 6.

Unique application processing requirements

For a description of processing requirements, see section 7.

2.1.2.5 Healthcare secondary packaging (Regulated healthcare retail consumer trade items)

A regulated healthcare retail consumer trade item (RHRCTI) trade item not intended to be scanned in high volumes per consumer transaction at retail, but does require additional data beyond GTIN to support regulatory requirements. This means, these trade items support:

- GTIN-8, GTIN-12, or GTIN-13 data structures.
- GTIN attributes such as batch/lot number, expiration dates, or serial numbers.

They may be marked with 2D matrix barcodes that require imaging-based scanners or linear symbologies such as GS1 DataBar or GS1-128. If an item is a general retail consumer trade item and regulated healthcare retail consumer trade item, then the barcode marking for general retail is required at a minimum.

GS1 key

Definition

- The GTIN-8 is the 8-digit GS1 identification key composed of a GS1-8 Prefix, item reference, and check digit used to identify trade items.

- The GTIN-12 is the 12-digit GS1 identification key composed of a U.P.C. Company Prefix, item reference, and check digit used to identify trade items.
- The GTIN-13 is the 13-digit GS1 identification key composed of a GS1 Company Prefix, item reference, and check digit used to identify trade items.

GS1 firmly endorses the use of GTIN in all markets, however there are instances where GS1 Member Organisations have allocated a portion of their numbering capacity to identification schemes administered nationally by external agencies.

These coding schemes while recognised within the GS1 system framework by the assignment of a GS1 Prefix are defined, in Healthcare, as National Trade Items Numbers (NTINs) rather than Global Trade item Numbers (GTINs). NTINs are unique with respect to GTINs as their values are a subset of all possible values of GTIN. However, their definition, allocation and lifecycle rules are defined by an organisation external to GS1.

The degree to which NTIN definitions and rules are compatible with those of GTIN is specific to each National definition. Whilst NTIN will always provide globally unique identification within the GTIN pool of numbers, this does not mean NTIN provides the same level of interoperability as GTIN with other GS1 standards, such as GDSN and ONS. In markets where NTIN is adopted exclusively of GTIN the reciprocal nature of GTIN identification and marking across markets is lost and becomes problematic where one package which should serve multiple markets (e.g. common language) requires multiple NTINs rather than one GTIN.

Rules

In addition to the GTIN rules described in section 4, see section [2.1.2.1.4](#) for rules on deploying GTIN-8.

Attributes

Required

Figure 2.1.2.5-1. Overview of required attributes

AIDC marking level for regulated healthcare trade items	Key	Batch/lot number - AI (10)	Expiration date - AI (17)	Serial number - AI (21)	Other
Minimum – Pharmaceutical & medical device	GTIN-8, GTIN-12, or GTIN-13	Yes	Yes	No	None
Enhanced – Pharmaceutical & medical device	GTIN-8, GTIN-12, or GTIN-13	Yes	Yes	No	None
Highest – Brand owner AIDC marking	GTIN-8, GTIN-12, or GTIN-13	Yes	Yes	Yes	Potency AI (7004) (for pharmaceutical, and for medical device kits with pharmaceuticals)
Highest – Hospital AIDC marking of pharmaceuticals	GTIN-8, GTIN-12, or GTIN-13	No	Yes, AI (7003) if needed for short life items	Yes	None
Highest - Hospital AIDC marking of certain medical devices (see section 2.1.2.7)	GRAI, AI (8003), or GIAI, AI (8004), is optional if GTIN, AI (01), + serial number, AI (21), is not marked on the product.	No	No	GRAI, AI (8003), or GIAI, AI (8004), is optional if GTIN, AI (01), + serial number, AI (21), is not marked on the product.	

To manage healthcare data requirements within EPC/RFID tags, see section [3.11](#) and the most recent version of the *EPC Tag Data Standard*.

Optional

For compliance with a national/regional regulatory or industry requirement where the GTIN will not meet the need, a Regulated Healthcare Trade Item may be identified with GTIN and AI (710), AI (711), AI (712), and AI (713) National Healthcare Reimbursement Number. See section [3.8.17](#) for details on the use of AI (710), AI (711), AI (712), and AI (713).

Rules

National Healthcare Reimbursement Number AI (710), AI (711), AI (712), and AI (713) must always be used with the GTIN.

Data carrier specification

Carrier choices

See the “data carrier specification carrier choices” recommendations on preferred options, options in addition to the barcode and other acceptable options found at the end of section [2.1.2.4](#).

Symbol X-dimensions, minimum symbol height, and minimum symbol quality

For regulated healthcare consumer trade items scanned in retail pharmacy and general distribution or non-retail pharmacy and general distribution see section [5.5.2.7.8](#), GS1 system symbol specification table 8.

For regulated healthcare retail consumer trade items not scanned in general distribution see section [5.5.2.7.10](#), GS1 system symbol specification table 10.

Symbol placement

All the symbol placement guidelines defined in section 6.

Unique application processing requirements

For a description of processing requirements, see section 7.

2.1.2.6 Trade items intended for general distribution scanning only

Every trade item that is different from another in any respect is assigned a unique Global Trade Item Number (GTIN). This includes trade item groupings of retail and non-retail trade items that are also trade items, and non-retail single units. For example, each of the packaging types in the figure below, if traded, is assigned a separate GTIN.

Figure 2.1.2.6-1. Example of GTIN numbering options

Trade item	GTIN numbering options			
	GTIN-8	GTIN-12	GTIN-13	GTIN-14
Single product A	X	X	X	
50 x product A (Trade item grouping)		X	X	X
50 x product A (Trade item grouping, e.g., display case)		X	X	X
100 x product A (Trade item grouping)		X	X	X
Single product B	X	X	X	
50 x product A 50 x product B		X	X	

2.1.2.6.1 Identification of a trade item that is a single product

Application description

The manufacturer or supplier has the option of assigning a unique GTIN-8, GTIN-12, GTIN-13 or in the case of regulated healthcare trade items and trade items used in manufacturing and maintenance, repair & overhaul (MRO) processes, GTIN-14 to a trade item that is a single product as shown in figure 2.1.2.6-1. Restricted Circulation Numbers (RCNs) must not be used in this element string.

GS1 key

Definition

- The GTIN-8 is the 8-digit GS1 identification key composed of a GS1-8 Prefix, item reference, and check digit used to identify trade items.
- The GTIN-12 is the 12-digit GS1 identification key composed of a U.P.C. Company Prefix, item reference, and check digit used to identify trade items.
- The GTIN-13 is the 13-digit GS1 identification key composed of a GS1 Company Prefix, item reference, and check digit used to identify trade items.
- For regulated healthcare trade items and trade items used in manufacturing and maintenance, repair & overhaul (MRO) processes the GTIN-14 is the 14-digit GS1 identification key composed of an indicator digit (1-9), GS1 Company Prefix, item reference, and check digit used to identify trade items.

Rules

In addition to the GTIN rules described in section 4, the following guidelines should be observed: GTIN-8 can only be used when all other pack size constraints are met.

Before deciding to use a GTIN-8 as opposed to a GTIN-12, GTIN-13, or in the case of regulated healthcare trade items, GTIN-14, companies, working jointly with their printer, should consider options such as:

- Whether the barcode can be reduced in size (e.g., printed at a lower X-dimension, taking into account the minimum barcode print quality requirements (see section [5.5](#)).
- Whether the label or artwork can reasonably be changed to enable the inclusion of an EAN-13 or a UPC-A barcode or a symbol from the GS1 DataBar Retail POS family.
- For example, redesigning the label and increasing the label size may be an option, especially when the existing label is small in comparison with the pack area.
- Whether a truncated barcode can be used.



Note: A truncated barcode (normal length, but reduced in height) may only be used if there is absolutely no possibility of printing a full size barcode. Truncation removes the omnidirectional scanning capability. A barcode with excessive truncation will not be of any practical use. Users considering this option should consult their customers to see if an acceptable compromise can be reached.

Pack size constraints

The use of a GTIN-8 is authorised when:

- The total printable area of the product packaging is less than 80 cm², or
- The area of the largest label for the item is less than 40 cm², or
- The product is cylindrical with a diameter less than 30 mm.

Figure 2.1.2.6.1-1. GTIN-8 pack size constraints

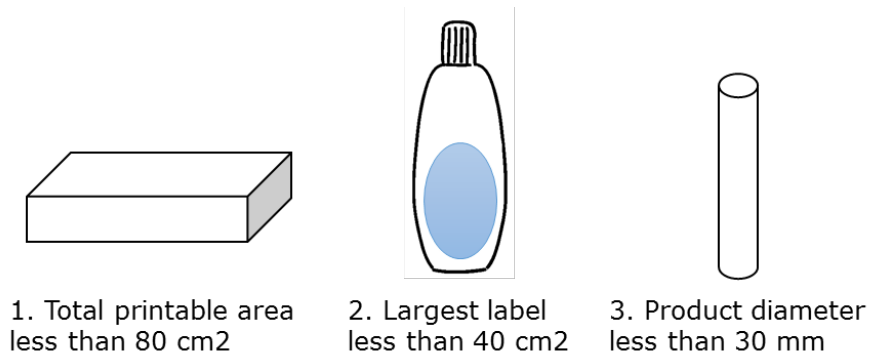

Attributes

Required

For regulated healthcare consumer trade items the following levels of AIDC marking are specified.

Figure 2.1.2.6.1-2. Overview of required attributes

AIDC marking level for regulated healthcare trade items	Key	Batch/lot number - AI (10)	Expiration date - AI (17)	Serial number - AI (21)	Other
Minimum	GTIN-8, GTIN-12, GTIN-13, or GTIN-14	Yes	Yes	No	None
Enhanced	GTIN-8, GTIN-12, GTIN-13, or GTIN-14	Yes	Yes	No	None
Highest – Brand owner AIDC marking	GTIN-8, GTIN-12, GTIN-13, or GTIN-14	Yes	Yes	Yes	Potency AI (7004) for pharmaceutical, and for medical device kits with pharmaceutical (cases only for both situations)
Highest – Hospital AIDC marking of pharmaceutical	GTIN-8, GTIN-12, GTIN-13, or GTIN-14	No	AI (7003) for short-life products	Yes	None
Hospital AIDC marking of medical devices	No	No	No	No	None

To manage healthcare data requirements within EPC/RFID tags, see section [3.11](#) and the most recent version of the *EPC Tag Data Standard*.

Optional

Not applicable

Rules

Not applicable

Data carrier specification

Carrier choices

Symbols from the EAN/UPC symbology family (UPC-A, UPC-E, may be used to encode the GTIN-12, EAN-13 to encode the GTIN-13 and, if the size requirements are met, EAN-8 to encode the GTIN-8 of the trade item that is a single product).

ITF-14 symbols may be used where printing conditions require the application of a less demanding symbology. ITF-14 symbols can encode the GTIN-12, or GTIN-13 of the item.

A GS1-128 barcode or GS1 DataBar barcode (*) with GS1 Application Identifier (01) may be used to encode a GTIN that identifies the trade item if the printing conditions allow. The choice of one of these symbologies is particularly relevant if there is a need to encode attribute information in addition to the identification number.

 **Note:** A GS1 DataBar barcode SHALL NOT be used to encode a GTIN-14 constructed from an ISBN.

(*) In 2014 GS1 DataBar became an open symbology and all scanning environments must be able to read these symbols.

For trade items used in manufacturing and maintenance, repair & overhaul (MRO) processes the following data carrier choices take precedence over the carrier choices above: GS1-128, GS1 DataMatrix, GS1 QR Code and EPC/RFID.

For healthcare, the following carrier selections take precedence over the carrier choices above and apply to all regulated healthcare retail consumer trade items.

Figure 2.1.2.6.1-3. Healthcare carrier choices

<p>Preferred option(s) (this is the long-term direction for AIDC marking)</p>	<p>First preference: GS1-128 symbology. After Jan 2010, GS1 DataBar is permitted for use on all trade items and therefore may be encountered in general distribution however use of GS1-128 is preferred as the scanners in the field today pervasively support it.</p> <p>Second preference: When one linear symbol cannot accommodate the field length of the data (exceeds 48 characters), two symbols should be used.</p> <p>Third option: Where the package or label size does not permit the use of the first two options, GS1 DataMatrix symbology are permitted but should be avoided wherever possible if the package could be scanned by a mounted conveyerised scanner.</p>
<p>Option in addition to the barcode</p>	<p>See the "data carrier specification carrier choices" recommendations on options in addition to the barcode at the end of section 2.1.2.4.</p>
<p>Other acceptable options (GS1 strongly supports existing options for symbol marking as a guiding principle and therefore supports all previous AIDC marking specifications)</p>	<p>See the "data carrier specification carrier choices" recommendations on other acceptable options found at the end of section 2.1.2.4.</p>

Symbol X-dimensions, minimum symbol height, and minimum symbol quality

For multi-sector use except for retail or regulated healthcare trade items see section [5.5.2.7.2](#), GS1 system symbol specification table 2.

For regulated healthcare non-retail consumer trade items see section [5.5.2.7.8](#), GS1 system symbol specification table 8.

For manufacturing and MRO processes see [5.5.2.7.4](#), GS1 system symbol specification table 4.

Symbol placement

All the symbol placement guidelines defined in section 6.

Unique application processing requirements

For a description of processing requirements, see section 7.

2.1.2.6.2 Trade item groupings of identical trade items

Application description

A trade item grouping that is a predefined grouping of identical trade items. The manufacturer or supplier has the option of either assigning a unique GTIN-13 or GTIN-12 to each trade item grouping or assigning a unique GTIN-14. These 14-digit GTINs incorporate the GTIN (less its check

digit) of the trade item contained in each grouping. The check digit for each GTIN-14 is then recalculated.

The indicators have no meaning. The digits do not have to be used in sequential order, and some may not be used at all. The GTIN-14 structure for trade item groupings creates extra numbering capacity. Indicators can be reused.

Figure 2.1.2.6.2-1. GTIN-14 data structures

Global Trade Item Number (GTIN)														
Indicator	GTIN of contained trade items (without check digit)												Check digit	
GTIN-8 based	N ₁	0	0	0	0	0	N ₇	N ₈	N ₉	N ₁₀	N ₁₁	N ₁₂	N ₁₃	N ₁₄
GTIN-12 based	N ₁	0	N ₃	N ₄	N ₅	N ₆	N ₇	N ₈	N ₉	N ₁₀	N ₁₁	N ₁₂	N ₁₃	N ₁₄
GTIN-13 based	N ₁	N ₂	N ₃	N ₄	N ₅	N ₆	N ₇	N ₈	N ₉	N ₁₀	N ₁₁	N ₁₂	N ₁₃	N ₁₄

The indicator is a digit with a value of 1 to 8. It is assigned as required by the company that constructs the identification number. It can provide up to eight separate GTIN-14s to identify trade item groupings.

For packaging configuration hierarchies which include a retail consumer trade item identified with a GTIN-13, GTIN-12, or GTIN-8, this GTIN must always be one of the relevant levels of packaging contained, usually the lowest level (see note below related to GTIN-14 assignment on the primary packaging). Restricted Circulation Numbers must not be used in this element string.

 **Note:** regulated healthcare trade items on the primary packaging, the phrase “usually the lowest level” SHALL be interpreted as allowing for the use of GTIN-14 on packaging configurations below the retail consumer trade item level, if one exists. This interpretation may not be applied to other trade item categories such as Do It Yourself (DIY) or Foodservice.

Any product package which will encounter scanning or product listing for sale at point-of-sale SHALL be identified according to retail point-of-sale specifications.

When a GTIN change at the retail consumer trade item level is required, the GTIN change must be made at all configuration levels above the retail consumer trade item level. Where there is an association between primary packaging and retail consumer trade item levels and GTIN -14 assignment is used on the primary packaging, the GTIN-14 assigned to the primary packaging is based on the retail level GTIN. There are three scenarios to consider for the relationship of these GTIN assignments:

- If changes to the primary packaging drive the change of the GTIN assigned to the retail consumer trade item level, the GTIN of the primary packaging will change.
- If changes to retail consumer trade item level GTIN are not caused by a change in primary packaging, the GTIN at the primary package level may or may not change per the discretion of the brand owner.
- If additional retail level package(s) are introduced beyond the original retail package or replace the original retail package, the GTIN-14 on the primary packing may remain tied to the original retail level GTIN.

The check digit is explained in section [7.9](#). Its verification, usually carried out automatically by the barcode reader, ensures that the number is correctly composed.

Figure 2.1.2.6.2-2. Different groupings of the same trade item

Indicator	GTIN of trade item contained in the grouping, less its check digit	New check digit	Description	Quantity
	061414112345	2	Trade item	Single
1	061414112345	9	Trade item grouping	A grouping
...
8	061414112345	8	Trade item grouping	Another grouping

Indicators 1 to 8 may be used to create new GTIN-14s. When these eight indicators have been used, further groupings must be identified with either a GTIN-13 or GTIN-12. (Indicator digit 9 is reserved for variable measure trade items). (See section [2.1.5](#)).

GS1 key

Definition

- The GTIN-8 is the 8-digit GS1 identification key composed of a GS1-8 Prefix, item reference, and check digit used to identify trade items
- The GTIN-12 is the 12-digit GS1 identification key composed of a U.P.C. Company Prefix, item reference, and check digit used to identify trade items.
- The GTIN-13 is the 13-digit GS1 identification key composed of a GS1 Company Prefix, item reference, and check digit used to identify trade items.
- The GTIN-14 is the 14-digit GS1 identification key composed of an indicator digit (1-9), GS1 Company Prefix, item reference, and check digit used to identify trade items.

Rules

All the GTIN rules described in section 4.

Attributes

Required

For regulated healthcare consumer trade items the following levels of AIDC marking are specified:

Figure 2.1.2.6.2-3. Required attributes

AIDC marking level for regulated healthcare trade items	Key	Batch/lot number - AI (10)	Expiration date - AI (17)	Serial number - AI (21)	Other
Minimum	GTIN-8, GTIN-12, GTIN-13, or GTIN-14	Yes	Yes	No	None
Enhanced	GTIN-8, GTIN-12, GTIN-13, or GTIN-14	Yes	Yes	No	None
Highest – Brand owner AIDC marking	GTIN-8, GTIN-12, GTIN-13, or GTIN-14	Yes	Yes	Yes	Potency AI (7004) for pharmaceutical, and for medical device kits with pharmaceutical (cases only for both situations)
Highest – Hospital AIDC marking of pharmaceutical	GTIN-8, GTIN-12, GTIN-13, or GTIN-14	No	AI (7003) for short-life products	Yes	None
Hospital AIDC marking of medical devices	No	No	No	No	None

To manage healthcare data requirements within EPC/RFID tags, see section [3.11](#) and the most recent version of the *EPC Tag Data Standard*.

Optional

Not applicable

Rules

Not applicable

Data carrier specification**Carrier choices**

For multi-sector use symbols from the EAN/UPC symbology family (UPC-A, UPC-E, and EAN-13) may be used to encode the GTIN-12 or GTIN-13 of the trade item grouping. If used, the GTIN-8 is encoded in an EAN-8 barcode. GTIN-8 can only be used when all other pack size constraints are met, see section [2.1.2.1.4](#). The system recognises this element string by the symbology identifier]E0.

ITF-14 symbols may be used on trade item groupings where printing conditions require the application of a less demanding symbology. ITF-14 symbols can encode the GTIN-12, GTIN-13, or GTIN-14 of the item. The system recognises this element string by the symbology identifier]I1 and the number of digits decoded (14).

A GS1-128 barcode or GS1 DataBar barcode (*) with GS1 Application Identifier (01) may be used to encode a GTIN-12, GTIN-13, or GTIN-14 that identifies the trade item if the printing conditions allow. The choice of one of these symbologies is particularly relevant if there is a need to encode attribute information in addition to the identification number. The system recognises this element string by the symbology identifier (]C1 for GS-128,]e0 for GS1 DataBar) and the GS1 application identifier.



Note: A GS1 DataBar barcode SHALL NOT be used to encode a GTIN-14 constructed from an ISBN.

(*) In 2014 GS1 DataBar became an open symbology and all scanning environments must be able to read these symbols.

For trade items used in manufacturing and maintenance, repair & overhaul (MRO) processes the following data carrier choices take precedence over the carrier choices above: GS1-128, GS1 DataMatrix, GS1 QR Code and EPC/RFID.

For healthcare the carrier selections noted at the end of section [2.1.2.6.1](#) take precedence over the carrier choices above and apply to all regulated healthcare retail consumer trade items.

Symbol X-dimensions, minimum symbol height, and minimum symbol quality

For multi-sector use other than regulated healthcare trade items see section [5.5.2.7.2](#), GS1 system symbol specification table 2.

For regulated healthcare non-retail consumer trade items see section [5.5.2.7.8](#), GS1 system symbol specification table 8.

For manufacturing and MRO processes see [5.5.2.7.4](#), GS1 system symbol specification table 4.

Symbol placement

All the symbol placement guidelines defined in section 6.

Unique application processing requirements

For a description of processing requirements, see section 7.

2.1.2.6.3 Trade item Groupings of mixed trade items**Application description**

A trade item grouping that is a predefined grouping of two or more different trade items.

For example:

- Product C is a grouping of Product A (GTIN 'A') and Product B (GTIN 'B'), and is identified with either a GTIN-12 or GTIN-13, GTIN 'C.'
- GTIN 'C' could then be used to construct a GTIN-14 for a trade item grouping comprised of Product C.

As shown in figure 2.1.2.6.3-1, the GTIN-12s 614141234561 and 614141345670 identify the two trade items in the assortment identified by the GTIN 614141456789.

Figure 2.1.2.6.3-1. Example of trade item grouping of mixed trade items

Indicator	GTIN of trade item less its check digit	Check digit	Description	Quantity
	061414123456 061414134567	1 0	Retail consumer trade item (Product A) Retail consumer trade item (Product B)	Single Single
	061414145678	9	Retail consumer trade item (Product C)	Assortment
1	061414145678	6	Trade item grouping	A grouping of the assortment
...
8	061414145678	5	Trade item grouping	Another grouping of the assortment

The indicators 1 to 8 may be used to create new GTIN-14s. When these eight indicators have been used, further groupings must be identified with either a GTIN-13 or GTIN-12. (Indicator digit 9 is reserved for variable measure trade items). (See section [2.1.5](#)).

GS1 key

Definition

- The GTIN-12 is the 12-digit GS1 identification key composed of a U.P.C. Company Prefix, item reference, and check digit used to identify trade items.
- The GTIN-13 is the 13-digit GS1 identification key composed of a GS1 Company Prefix, item reference, and check digit used to identify trade items.
- The GTIN-14 is the 14-digit GS1 identification key composed of an indicator digit (1-9), GS1 Company Prefix, item reference, and check digit used to identify trade items

Rules

All the GTIN rules described in section 4; in addition, the GTIN-14 is valid for trade item groupings only when the trade item contained is a mixed assortment of two or more different trade items.

Attributes

Required

Not applicable

Optional

Not applicable

Data carrier specification

Carrier choices

Symbols from the EAN/UPC symbology family (UPC-A, UPC-E, and EAN-13) may be used to encode the GTIN-12 or GTIN-13 of the trade item grouping. The system recognises this element string by the symbology identifier **JE0**.

ITF-14 symbols may be used on trade item groupings where printing conditions require the application of a less demanding symbology. ITF-14 symbols can encode the GTIN-12, GTIN-13, or GTIN-14 of the item. The system recognises this element string by the symbology identifier **J11** and the number of digits decoded (14).

A GS1-128 barcode or GS1 DataBar barcode (*) with GS1 Application Identifier (01) may be used to encode a GTIN-12, GTIN-13, or GTIN-14 that identifies the trade item if the printing conditions allow. The choice of one of these symbologies is particularly relevant if there is a need to encode attribute information in addition to the identification number. The system recognises this element string by the symbology identifier (**JC1** for GS1-128, **Je0** for GS1 DataBar) and the GS1 Application Identifier.



Note: A GS1 DataBar barcode SHALL NOT be used to encode a GTIN-14 constructed from an ISBN.

(*) In 2014 GS1 DataBar became an open symbology and all scanning environments must be able to read these symbols.

For trade items used in manufacturing and maintenance, repair & overhaul (MRO) processes the following data carrier choices take precedence over the carrier choices above: GS1-128, GS1 DataMatrix, GS1 QR Code and EPC/RFID.

For healthcare, the carrier selections noted at the end of section [2.1.2.6.1](#) take precedence over the Carrier Choices above and apply to all regulated healthcare retail consumer trade items.

Symbol X-dimensions, minimum symbol height, and minimum symbol quality

For multi-sector use other than regulated healthcare trade items see section [5.5.2.7.2](#), GS1 system symbol specification table 2.

For regulated healthcare non-retail consumer trade items see section [5.5.2.7.8](#), GS1 system symbol specification table 8.

For manufacturing and MRO processes see [5.5.2.7.4](#), GS1 system symbol specification table 4.

Symbol placement

All the symbol placement guidelines defined in section 6.

Unique application processing requirements

For a description of processing requirements, see section 7.

2.1.2.7 Medical devices (non-retail trade items)

Application description

Within this application are the rules and recommendations for the direct part marking (DPM) of medical devices for the Automatic Identification and Data Capture (AIDC) management, including medical devices that are reprocessed (within the micro-logistics cycle of use, including cleaning and sterilisation).

Medical devices SHOULD be identified with GTIN and any appropriate GS1 Application Identifiers used for production control, as determined by the responsible entity for the device. For medical devices that are reprocessed, GTIN and serial number are recommended for manufacturers that use DPM to enable traceability throughout the product lifecycle.

Also, for hospitals or instrument owners that mark medical devices that are reprocessed, GTIN and serial number are recommended for all hospital / instrument owner marking. Some existing in-house legacy systems already use GS1 asset identifiers (GIAI or GRAI, see section [2.3](#)), which are compliant with GS1 standards.



Note: Only one GS1 key (GTIN or GIAI/GRAI) SHOULD be marked on a single instrument.

GS1 key

Definition

- The GTIN-12 is the 12-digit GS1 identification key composed of a U.P.C. Company Prefix, item reference, and check digit used to identify trade items.

- The GTIN-13 is the 13-digit GS1 identification key composed of a GS1 Company Prefix, item reference, and check digit used to identify trade items.
- The GTIN-14 is the 14-digit GS1 identification key composed of an indicator digit (1-9), GS1 Company Prefix, item reference, and check digit used to identify trade items.
- The GRAI is the GS1 identification key used to identify returnable assets. The key is comprised of a GS1 Company Prefix, asset type, check digit, and optional serial number.
- The GIAI is the GS1 identification key used to identify an individual asset. The key is comprised of a GS1 Company Prefix and an individual asset reference.

Rules

- All the GTIN rules described in section 4.
- All the GIAI and GRAI application rules described in section 4.
- If the AIDC marking on the medical device may be seen and scanned when placed in the protective packaging after sterilisation, the protective packaging will not have to be AIDC marked.

Attributes**Required**

Not applicable

Optional

When using GTIN-12, GTIN-13, or GTIN-14 to identify a medical device that is reprocessed, a serial number is recommended to complete the identification. To manage GS1 healthcare data requirements within EPC/RFID tags, see section [3.11](#) and the *EPC Tag Data Standard*.

Rules

Not applicable

Data carrier specification**Carrier choices**

Medical devices (non-retail trade items), when direct marked, SHALL be marked with GS1 DataMatrix symbology. See section [2.1.4](#) Direct marking for more detail.

Symbol X-dimensions, minimum symbol height, and minimum symbol quality

See section [5.5.2.7.7](#), GS1 system symbol specification table 7.

Symbol placement

All the symbol placement guidelines defined in section 6.

Unique application processing requirements

For a description of processing requirements, see section 7.

2.1.3 Fixed measure trade items packed in several individual pieces not scanned at POS

Application description

The trade item includes two or more pieces that are marked for other purposes such as inventory management, theft prevention, or quality control. The identifier of each individual piece consists of the Global Trade Item Number (GTIN) of the trade item, the piece number, and the total count of pieces in the trade item. The GTIN on all pieces of the trade item must be the same.

GS1 key

Definition

The Global Trade Item Number (GTIN) is the GS1 identification key used to identify trade items. For the identification of pieces of a trade item, additional information is provided with a piece number and the total number of pieces. See section [3.2](#), Identification of an individual trade item piece: AI (8006).

Rules

- AI (8006) SHALL NOT be used for the identification of a single trade item piece.
- AI (8006) SHALL NOT be used for the identification of pieces that are themselves trade items, such as spare parts.
- The value of AI (8006) of all pieces of a trade item SHALL contain the same GTIN, the same total number of pieces and a different piece number.
- When the pieces of a trade item are packaged together, the value of the GTIN marked on the package SHALL be the same as the GTIN marked on the contained physical units.
- For trade items that pass the point-of-sale, all of the pieces of the trade item SHALL be packaged or presented together and identified with the GTIN.

Also see the GTIN rules described in section 4.

Attributes

Required

Not applicable.

Optional

See section 3 for an overview of all GS1 Application Identifiers and their intended usage.

Rules

See section [4.13](#) *Data relationships* for rules on valid and invalid associations of element strings. If used, optional AIs on all pieces of a trade item and on the trade item itself SHALL be identical.

Data carrier specification

Carrier choices

For multi-sector use except for regulated healthcare retail consumer trade items, data carriers used to represent each individual piece using the GS1 Application Identifier AI (8006) are GS1-128, GS1 DataMatrix, GS1 QR Code and EPC/RFID.

For healthcare, the following carrier selections take precedence over the carrier choices above and apply to all regulated healthcare retail consumer trade items.

Figure 2.1.3-1. Healthcare carrier choices

Preferred Option	GS1-128 symbology
Option in addition to the barcode	See the "Data Carrier Specification Carrier Choices" recommendations on Options in Addition to the barcode at the end of section 2.1.2.4

Symbol X-dimensions, minimum symbol height, and minimum symbol quality

See sections [5.5.2.7.2](#), GS1 system symbol specification table 2, and [5.5.2.7.4](#), GS1 system symbol specification table 4.

Symbol placement

All the symbol placement guidelines defined in section 6.

Unique application processing requirements

For a description of processing requirements, see section 7.

2.1.4 Direct marking

Application description

Direct marking is the process of applying a permanent mark to the trade item, in order for it to be identified during its full lifetime independent of its packaging.

Three methods exist for the direct marking of trade items:

1. Direct part marking (DPM): The process of marking a symbol directly onto an item using an intrusive or non-intrusive method instead of applying a label or using another indirect marking process.
2. Durable labelling: The process of marking a symbol onto a label that is intended to permanently stay on the trade item.
3. Durable RFID-tagging: The process of applying an RFID-tag that is intended to permanently stay on the trade item.

GS1 key

Definition

- The GTIN-12 is the 12-digit GS1 identification key composed of a U.P.C. Company Prefix, item reference, and check digit used to identify trade items.
- The GTIN-13 is the 13-digit GS1 identification key composed of a GS1 Company Prefix, item reference, and check digit used to identify trade items.
- The GTIN-14 is the 14-digit GS1 identification key composed of an indicator digit (1-9), GS1 Company Prefix, item reference, and check digit used to identify trade items.
- The GRAI is the GS1 identification key used to identify returnable assets. The key is comprised of a GS1 Company Prefix, asset type, check digit, and optional serial number.
- The GIAI is the GS1 identification key used to identify an individual asset. The key is comprised of a GS1 Company Prefix and an Individual Asset Reference.

Rules

GTIN rules are described in section 4.

Attributes

Required

For regulated healthcare consumer trade items the following levels of AIDC marking are specified:

Figure 2.1.4-1. AIDC marking levels for regulated healthcare consumer trade items

AIDC marking level for regulated healthcare trade items	Key	Batch/lot number - AI (10)	Expiration date - AI (17)	Serial number - AI (21)	Other
Highest – Brand owner AIDC marking of certain medical devices	GTIN-12, GTIN-13, or GTIN-14	No	No	Yes	None
Highest - Hospital AIDC marking of certain medical devices (see section 2.1.2.7)	GRAI, AI (8003), or GIAI, AI (8004), is optional if GTIN, AI (01), + serial number, AI (21), is not marked on the product.	No	No	GRAI, AI (8003), or GIAI, AI (8004), is optional if GTIN, AI (01), + serial number, AI (21), is not marked on the product.	

To manage healthcare data requirements within EPC/RFID tags, see section [3.11](#) and the most recent version of the *EPC Tag Data Standard*.

Optional

See section 3 for all the GS1 Application Identifiers (AIs) that can be used with a GTIN. Since the GTIN identifies a grouping of items, the optional attributes apply to the grouping as well.

Rules

All the GTIN rules described in section 4.

Data carrier specification

Carrier choices

- GS1 DataMatrix
- GS1 QR Code
- EPC/RFID

For healthcare, the following carrier selection applies to regulated healthcare retail consumer trade items.

Figure 2.1.4-2. Carrier choices for regulated healthcare retail consumer trade items

Preferred option	GS1 DataMatrix symbology
Option in addition to the barcode	See the "Data carrier specification carrier choices" recommendations on options in addition to the barcode at the end of section 2.1.2.4

Figure 2.1.4-3. Example of GS1 DataMatrix symbol encoded with GTIN and AIs (17) and (10) per section [2.1.2.4](#)

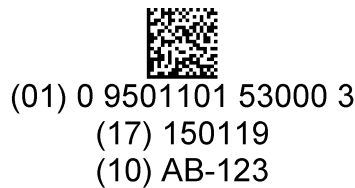

Figure 2.1.4-4. Example of GS1 DataMatrix symbol encoded with GTIN and serial number AI (21)



Symbol X-dimensions, minimum symbol height, and minimum symbol quality

Direct part marking:

The use of GS1 DataMatrix and GS1 QR Code in direct part marking applications is endorsed by GS1 for those applications that require permanent marking for cradle-to-grave history of the part's lifecycle. For regulated healthcare trade items including medical devices, GS1 DataMatrix is the only GS1 data carrier approved for direct part marking application.

Some sources express the height of the 2D cell in terms of a Y dimension. For GS1 DataMatrix and GS1 QR Code the cells are considered the same size under optimal print conditions so that X = Y.

Symbol size is determined by the amount of data and the number of rows and columns required encoding the data for the X-dimensions selected (see figures 5.7.3.2-1 and 5.7.3.2-2).

Consult GS1 system symbol specification table 7, section [5.5.2.7.7](#), for minimum and maximum X-dimensions and other sizing requirements.

Durable labelling:

See section [5.5.2.7.4](#), GS1 system symbol specification table 4.

Symbol placement

General principles on placement of barcodes are described in section 6.

The majority of uses for these symbols will be on very small items with curved surfaces such as vials, ampoules, and very small bottles. For guidance in locating these symbols on curved surfaces, refer to section [6.2](#).

Unique application processing requirements for direct part marking**Marking methods**

It is important to analyse the selected method of marking in relation to several considerations:

- Finishes that cause an excess of shadowing or glare.
- Surfaces that do not provide sufficient contrast - less than 20 percent difference in surface reflectance.
- Safety critical parts that cannot be marked with intrusive methods.
- Marking method must comply with the users' requirements.
- Location of the symbol should not be:
 - In direct air/water (streams, etc.).
 - On sealing surfaces.
 - On surfaces subject to wear or exposure to heavy contact.

Intrusive (subtractive methods)

Intrusive marking refers to methods that remove or alter the material of the host.

- Abrasive blast.
- Dot peen.
- Electro-chemical marking, colouring, or etching.
- Engraving/milling.
- Fabric embroidery/weaving.
- Direct laser marking.
- Laser shot peening.
- Laser Inducted Surface Improvement (LISI).
- Gas Assisted Laser Etch (GALE).
- Laser Induced Vapour Deposition (LIVD).

Non-intrusive (additive methods)

Non-Intrusive marking does not affect the host material; it usually involves the addition of material.

- Cast, forge, mold.
- Inkjet
- Laser bonding.
- Liquid metal jet.
- Silk screen.
- Stencil

Host (substrate) surface

Direct part marking of GS1 DataMatrix or GS1 QR Code SHOULD be reserved for surfaces no rougher than 250 micro inches (millionths of an inch) and for surfaces that are no smoother than 8 micro inches. Surfaces that fall outside these parameters need to be re-surfaced or marked using an alternative method.

Consideration of the surface colour must be taken. A minimum 20 percent difference in contrast between the host and the symbol is required. Altering the cell size in relation to the surface roughness should provide adequate contrast on cast surfaces.

(Cell size = (0.00006 X roughness) + 0.0067); (see figure 2.1.4-5)

Figure 2.1.4-5. Cell size in relation to surface roughness

Average roughness	Cell size minimum
0,508 micrometres (20 micro inches)	0.1905 mm (0.0075 in.)
1,524 micrometres (60 micro inches)	0.2286 mm (0.009 in.)
3,048 micrometres (120 micro inches)	0.381 mm (0.015 in.)
5,08 micrometres (200 micro inches)	0.508 mm (0.020 in.)
7,62 micrometres (300 micro inches)	0.635 mm (0.025 in.)
10,668 micrometres (420 micro inches)	0.762 mm (0.030 in.)

Substrate surface thickness

A minimum host surface thickness is recommended as is a maximum marking depth. Both are outlined in the table below.

Figure 2.1.4-6. Marking depth and surface thickness by method

Method	Min. thickness	Max marking depth
Dot Peen	1.016 mm (0.04 in.)	0.102 mm (0.004 in.)
Laser Shot peening	0.508 mm (0.02 in.)	0.051 mm (0.002 in.)
Laser Bonding	0.025 mm (0.001 in.)	Surface Mark
Abrasive Blast	0.076 mm (0.003 in.)	0.008 mm (0.0003 in.)
Electro-Chemical Colouring	0.508 mm (0.02 in.)	0.051 mm (0.002 in.)
Laser Etch	0.762 mm (0.03 in.)	0.076 mm (0.003 in.)
LISI	1.016 mm (0.04 in.)	0.102 mm (0.004 in.)
Laser Engraving	1.27 mm (0.05 in.)	0.127 mm (0.005 in.)
Electro-Chemical Etch	2.54 mm (0.1 in.)	0.254 mm (0.01 in.)
Micro-Milling	31.75 mm (1.25 in.)	3.175 mm (0.125 in.)

Human readable interpretation

For human readable interpretation rules see section [4.14](#). For HRI rules specific to regulated healthcare retail consumer trade items, see section [4.14.1](#).

2.1.5 Variable measure trade items – packages / containers not scanned in general retail at point-of-sale

Application description

Trade items may be of variable measure either because the production process does not guarantee consistency in weight, size, or length (e.g., carcasses of meat, whole cheeses) or because the items are created to meet a special order that states a quantity (e.g., textiles ordered by the metre, glass ordered by the square metre).

Only trade items that are sold, ordered, or produced in quantities, which can vary continuously, are covered by the rules outlined in this section. Trade items that are sold in discrete and predefined bands (e.g., as a nominal weight) are treated as fixed measure trade items.

A trade item must be considered a variable measure trade item if its measure is variable at any point in the supply chain. For example, a supplier may sell and invoice chickens in cases of 15

kilograms each; therefore, the quantity of contained chickens will vary. The customer, a retailer in this example, may need to know the exact number of chickens contained in each case in order to organise the distribution to his stores. In this example, the supplier should source mark the trade item by using a variable measure Global Trade Item Number (GTIN) and the variable count element string.

See section 3 for the use of AI (242) Made-to-Order variation number and its use in the manufacturing and maintenance, repair & overhaul (MRO) environment.

Variable measure trade items not scanned at POS are identified with a GTIN-14 beginning with '9'. The digit 9 in the indicator position indicates that the item identified is a variable measure trade item that is not scanned at POS.

Unlike GTIN-14s beginning with indicator 1 to 8 which are used to identify fixed measure trade items (see section [2.1.2.6.2 Trade item groupings of identical trade items](#)), this GTIN-14 is not derived from the GTIN (without check digit) of the contained trade items.

The GTIN-14 must be processed in its entirety and not broken down into its constituent elements.

Figure 2.1.5-1. Format of the element string

Global Trade Item Number (GTIN)	
Indicator	GS1 Company Prefix Item reference Check digit
(GTIN-14) 9	N ₂ N ₃ N ₄ N ₅ N ₆ N ₇ N ₈ N ₉ N ₁₀ N ₁₁ N ₁₂ N ₁₃ N ₁₄

The check digit is explained in section [7.9](#). Its verification, usually carried out automatically by the barcode reader, ensures that the number is correctly composed. The symbology identifier shows whether or not the check digit has been validated. If it has not, the check digit verification must be programmed in the application software.

Any trade item of a given composition where the quantity/measure information cannot be pre-determined for any reason is a variable measure trade item. The most frequent types are shown in the figure below.

Figure 2.1.5-2. Main types of variable measure trade items

Type	Item description
A	Items traded in bulk, neither portioned nor pre-packed for retail sale, ordered in any quantity, and that are delivered as variable measure trade items (e.g., fish, fruit, vegetables, cables, carpets, timber, fabrics) The identification number denotes the item as a trade entity containing any quantity of the given product and, if applicable, the form of packaging. Weight or dimensions complete the identification of the individual unit.
B	Trade items ordered and delivered by piece (wrapped or unwrapped) and invoiced by weight or measure because weight or measure varies due to the nature of the product or due to the manufacturing process (e.g., whole cheese, sides of bacon, beef carcasses, fish, sausages, ham, chicken, cauliflower, motion picture films) The identification number denotes the item as a particular predefined entity and, if applicable, denotes the form of packaging. Price or weight or dimensions complete the identification of the individual item.
C	Portioned trade items, pre-packed for sale by weight to the consumer, not fixed in quantity. (e.g., meat, cheese, vegetables, fruit, fillets of fish, sliced poultry, cold cuts) The identification number denotes the item type according to business practice and the form in which it is packed. Price weight or dimension completes the identification of the individual unit.
D	Trade items with selectable dimensions where GS1 system standard numbering does not make sense to cover the multiplicity of all variations (e.g., wooden planks, carpeting) The identification number denotes the predefined basic trade item. The applicable dimension(s) completes the identification of the individual unit.
E	Composition of a fixed number of trade items that are Type B or Type C (e.g., a trade item containing 10 chickens (Type B).) The identification number denotes the trade item grouping as an entity and, if applicable, its form of packaging. The total weight of all items contained completes the identification of the particular trade item.
F	Trade items made to customer specifications, restricted in use to the Maintenance, Repairs and Operations industrial supply sector, and sold business-to-business. The identification number denotes a base custom item. The specific variation is identified by the Made-to-Order variation number. (See in section 3.2 for the list of all GS1 Application Identifiers).

GS1 key

Definition

The GTIN-14 is the 14-digit GS1 identification key composed of an indicator digit (9), GS1 Company Prefix, item reference, and check digit used to identify trade items.

Rules

The GTIN-14 with the indicator 9 is used to identify a variable measure trade item. The presence of the variable measure information is mandatory for the complete identification of a particular variable measure trade item. The digit 9 in the first position is an integral part of the GTIN.

The GTIN-14 data structure beginning with indicator 9 is not used on an item intended to cross the Point-of-sale. Numbering of variable measure fresh food trade items intended to cross point-of-sale is defined in section [2.1.7](#).

Attributes

Required

The GTIN-14 identifies a variable measure trade item with respect to its fixed attributes or characteristics. To complete the identification of a variable measure trade item, the presence of an element string representing a trade measure is mandatory.

Optional

Applicable trade measures depend on the nature of the product. They may be a quantity, a weight, or any dimension.

- An element string with GS1 Application Identifier (30) is used if the variable measure of the trade item is the number of items contained. In order to generate a short barcode, always enter an even number of digits in the data field "variable count of items" by inserting a leading zero if necessary. Concatenation of this element string with the GTIN of the item enhances the accuracy of the application (see section [3.6.1](#), Variable count of items: AI (30)).
- An element string with GS1 Application Identifiers (31nn), (32nn), (35nn), and (36nn) is used if the variable measure of the respective trade item is weight, dimension, area, or volume. Only one element string of a given unit of measure may be applied on a particular item. Several element strings containing trade measures are possible on a particular item if the item is available in either unit of measure and if the applicable unit of measure is not distinguished for ordering and billing. This might apply if weight must be expressed in kilograms and pounds (see section [3.2](#), Trade measures: AIs (31nn, 32nn, 35nn, 36nn)).



Note: The fourth (and last) digit of the AI indicates the implied decimal point position. The value 0 means that the measurement is expressed in the basic unit of measure associated with the AI (e.g., kilograms). A value of 1 decreases the measurement by a factor of 10, a value of 2 by a factor of 100, and so on. For example, this enables metric weights to be represented from 999 kilograms to 1/1000 of a milligram.

- An element string with GS1 Application Identifier (8001) contains the predefined variable fields of a roll product and it may be used for those variable roll products where the trade measures AI (31nn), (32nn), (35nn), (36nn) are not sufficient. The GTIN-14 can denote a basic roll product.

Rules

An element string with GS1 Application Identifier (30) SHOULD never be used to indicate the quantity contained in a fixed measure trade item. However, if it appears on a fixed measure trade item, it SHOULD not invalidate the trade item identification.

An element string with GS1 Application Identifier (8001) must never be used together with other element strings representing trade measures.

Data carrier specification

Carrier choices

Variable measure trade items not crossing a point-of-sale SHOULD be marked with an ITF-14 barcode, GS1-128 barcode or GS1 DataBar (*) barcode.



Note: A GS1 DataBar barcode SHALL NOT be used to encode a GTIN-14 constructed from an ISBN.

(*) In 2014 GS1 DataBar became an open symbology and all scanning environments must be able to read these symbols.

Symbol X-dimensions, minimum symbol height, and minimum symbol quality

See section [5.5.2.7.2](#), GS1 system symbol specification table 2.

Symbol placement

All the symbol placement guidelines defined in section 6.

Unique application processing requirements

For a description of processing requirements, see section 7.

Examples of variable measure trade item numbering and symbols

In the examples in the subsections that follow, the following factors apply:

- In order to be illustrative, all examples show the same presentation (e.g., price list, order, delivery, invoice, and recording in a data file).
- GS1-128 barcodes are used.
- The examples are given to demonstrate the correct use of a given GS1 Application Identifier when used. When AI (02) is not used, information about the shipment must be received using Electronic Data Interchange (EDI) or other means prior to its physical receipt.

Example 1: Traded by Piece

The following example shows the order and delivery of an item traded by piece and invoiced by weight.

- The supplier's catalogue contains one entry: one salami weighing ~ 500 grams
- The order for 100 units is delivered in three boxes. Each box is marked with an SSCC (Serial Shipping Container Code) and, optionally, with information on the content of the box, expressed as follows:
 - AI (02) indicates the variable measure Global Trade Item Number (GTIN) of the units contained within the box.
 - AI (3101) indicates the total weight of the items contained within the box.
 - AI (37) indicates the count of items contained within the box.
- The three boxes may be stored on a pallet that may itself be marked with an SSCC and, optionally, with information on the contents of the pallet, expressed as follows:
 - AI (02) indicates the variable measure GTIN of the units contained within the pallet.
 - AI (3101) indicates the total weight of the items contained within the pallet.
 - AI (37) indicates the count of items contained within the pallet.
- The invoice refers to the GTIN and quantity delivered and shows the total weight and the price per kilogram. The GTIN and quantity of the invoice match the GTIN and quantity of the order.

Figure 2.1.5-3. Example 1: Traded by piece, invoiced by weight

Process	Description	Element strings used / symbol marking of the items
Supplier's catalogue	1 Salami ~ 500 g	GTIN 97612345000018
Order	100 salamis	100 x 97612345000018
Delivery	three logistic units Unit 1 = 33 salamis, 16.7 kg Unit 2 = 33 salamis, 16.9 g Unit 3 = 34 salamis, 17.1 kg	Unit 1: 00 376123450000010008 02 97612345000018 3101 000167 37 33 Unit 2: 00 376123450000010015 02 97612345000018 3101 000169 37 33 Unit 3: 00 376123450000010022 02 97612345000018 3101 000171 37 34
	If delivery is made on a pallet	Pallet: 00 376123450000010039 02 97612345000018 3101 000507 37 0100
Invoice	GTIN of items and the total weight (50.7 kg) + the price per kg	100 x 97612345000018; 50.7 kg x price per kg

Data file logistic units	Identification of logistic unit (SSCC)	GTIN of contained trade items	Total trade weight of content (grams)	Number of units contained
Either pallet	376123450000010039	97612345000018	50700	100
or individual units	376123450000010008	97612345000018	16700	33
	376123450000010015	97612345000018	16900	33
	376123450000010022	97612345000018	17100	34

Data file trade items	GTIN of trade item	Total trade weight (grams)	Number of trade items
One record per identification number	97612345000018	50700	100

An element string with an GS1 Application Identifier (410) represents the Global Location Number (GLN) of the recipient of a logistic unit. The GLN refers to the address where a particular transport unit identified with an SSCC is to be delivered. This element string is used in single leg transport operations. A logistic unit may include a barcode carrying the GLN of the unit's intended destination. When scanning this element string, the data transmitted may be used to retrieve the related address and/or to sort the item by destination.

Example 2: Traded by trade item grouping

The following example shows the order and delivery of an item traded by trade item grouping and invoiced by weight.

- The supplier's catalogue contains one entry: one case of 20 steaks weighing ~ 200 grams each.
- The order is for three cases. Each case delivered is marked with the Global Trade Item Number (GTIN) of a single case followed by the actual weight of the items contained.
- The three cases may be stored on a pallet that may itself be marked with an SSCC (Serial Shipping Container Code) and, optionally, with information on the contents of the pallet, expressed as follows:
 - AI (02) indicates the variable measure GTIN of the units contained within the pallet.
 - AI (3102) indicates the total weight of the items contained within the pallet.
 - AI (37) indicates the count of cases contained within the pallet.
- The invoice refers to the GTIN and quantity delivered and shows the total weight and the price per kilogram. The GTIN and quantity of the invoice match the GTIN and quantity of the order.

Figure 2.1.5-4. Example 2: Traded by trade item grouping, invoiced by weight

Process	Description	Element strings used / symbol marking of the items
Supplier's catalogue	1 case of 20 steaks ~ 200 g vacuum packed	GTIN 97612345000117
Order	Three cases	3 x 97612345000117
Delivery	Three trade items Unit 1: weight = 4.150 kg Unit 2: weight = 4.070 kg Unit 3: weight = 3.980 kg	Unit 1: 01 97612345000117 3102 000415 Unit 2: 01 97612345000117 3102 000407 Unit 3: 01 97612345000117 3102 000398
	If delivery is made on a pallet	Pallet: 00 376123450000010091 02 97612345000117 3102 001220 37 03
Invoice	GTIN of items and the total weight (12.20 kg) + the price per kg	3 x 97612345000117; 12.2 kg x price per kg

Data file logistic units	Identification of logistic unit (SSCC)	GTIN of contained trade items	Total trade weight of content (Grams)	Number of units contained
Pallet	376123450000010091	97612345000117	12200	3

Data file trade items	GTIN of trade item	Total trade weight	Number of trade items
One Record	97612345000117	12200	3

Example 3: Traded in bulk

The following example shows an order and delivery of an item traded in bulk.

- The supplier's catalogue contains one entry: cabbage unwrapped sold in bulk by kilogram.
- The order is for 100 kilograms. It is delivered in two cases. Each case is marked with the Global Trade Item Number (GTIN) of the cabbage followed by the actual weight of the items contained.
- The two cases may be stored on a pallet that may itself be marked with an SSCC (Serial Shipping Container Code).
- The invoice refers to the GTIN as ordered and shows the total weight and the price per kilogram. The delivered weight may be verified as being close to the ordered quantity.

Figure 2.1.5-5. Example 3: Traded in bulk

Process	Description	Element strings used / symbol marking of the items
Supplier's catalogue	Cabbage unwrapped sold in bulk by kilogram	GTIN 97612345000049
Order	100 kg of cabbage	100 kg x 97612345000049
Delivery	Two trade items Unit 1: weight = 42.7 kg Unit 2: weight = 57.6 kg	Unit 1: 01 97612345000049 3101 000427 Unit 2: 01 97612345000049 3101 000576
	If delivery is made on a pallet	Pallet: 00 376123450000010107
Invoice	GTIN of item and the total weight (100.3 kg) + the price per kg	97612345000049 100.3 kg x price per kg

Data file logistic units	Identification of logistic unit (SSCC)	GTIN of contained trade items	Total trade weight of content (Grams)	Number of units contained
Pallet	37612345000010107	97612345000049	42700	1
		97612345000049	57600	1

Data file trade items	GTIN of trade item	Total trade weight (grams)	Number of trade items
One record per trade item	97612345000049	42700	1
	97612345000049	57600	1

Example 4: Traded by trade item grouping

The following example shows an order of variable measure trade items by case that are invoiced by the number of pieces delivered.

- The supplier's catalogue contains one entry: one case of ~ 10 cabbages sold by piece.
- The order is for two cases. Each case delivered is marked with the Global Trade Item Number (GTIN) of a single case followed by the actual count of the items contained.
- The two cases may be stored on a pallet that may itself be marked with an SSCC (Serial Shipping Container Code) and, optionally, with information on the contents of the pallet, expressed as follows:
 - AI (02) indicates the variable measure GTIN of the units contained within the pallet.
 - AI (30) indicates the total count of the items contained within the pallet.
 - AI (37) indicates the count of cases contained within the pallet.
- The invoice refers to the GTIN as ordered and delivered and the total count of items.

Figure 2.1.5-6. Example 4: Traded by trade item grouping, invoiced by piece

Process	Description	Element strings used / symbol marking of the items
Supplier's catalogue	Case containing ~10 cabbages sold by pieces	GTIN 97612345000285
Order	Two cases	2 x 97612345000285
Delivery	Unit 1: 11 pieces Unit 2: 12 pieces	Unit 1: 01 97612345000285 30 11 Unit 2: 01 97612345000285 30 12
	If delivery is made on a pallet	Pallet: 00 37612345000010138 02 97612345000285 30 23 37 02
Invoice	GTIN of the trade item and the total quantity	2 x 97612345000285 23 pieces x price per piece

Data file logistic units	Identification of logistic unit (SSCC)	GTIN of contained trade items	Total number of pieces contained in the trade item	Number of units contained
Pallet	37612345000010138	97612345000285	23	2

Data file trade items	GTIN of trade item	Total number of pieces	Number of trade items
One Record	97612345000285	23	2

Example 5: Traded in Bulk

The following example shows a product that can be purchased from a supplier or sold to a customer by any length in metres.

- The supplier's catalogue contains one entry: cable T49 sold in metres.
- The order is for one length of cable of 150 metres. The delivered package is marked with the Global Trade Item Number (GTIN) of the cable followed by the actual length of cable contained.
- The invoice refers to the GTIN as ordered and delivered and the total length.

Figure 2.1.5-7. Example 5: Traded in bulk

Process	Description	Element strings used / symbol marking of the items
Supplier's catalogue	Cable T49 sold in any length in MTR	GTIN 97612345000063
Order	One trade item of 150 MTR	97612345000063 x 150 MTR
Delivery	One trade item, 150 MTR	01 97612345000063 3110 000150
Invoice	GTIN of the trade item and the total quantity	1 x 97612345000063 150 x price per MTR

Data file trade items	GTIN of trade item	Total trade length (metres)
One record	97612345000063	150

2.1.6 Fixed measure trade items – restricted distribution

This section describes applications where the item identification is defined only in a closed environment. Therefore, the distribution of trade items marked in this way is restricted to a given geographic region or for use within a company. However, within their closed environment these items may be processed along with trade items identified with Global Trade Item Numbers (GTINs) defined for open trade.

The regulations established by GS1 Member Organisations for their country or assigned area should be observed for the allocation of these Restricted Circulation Numbers.

When assigned to company internal use, the structure and management of the numbers represented in the element strings of this section are the responsibility of the user. Number changes and reuse of expired numbers must be managed by the user based on their requirements.

When centrally administrated within a geographic area, the GS1 Member Organisation determines the structure and manages number allocation based on user requirements.

These identification numbers are known as Restricted Circulation Numbers and may be 8, 12, or 13 digits in length. Eight-digit numbers are known as RCN-8s, 12-digit numbers as RCN-12s, and 13-digit numbers as RCN-13s.

Restricted circulation fixed measure trade items are defined only in a closed environment. Therefore, the distribution of trade items marked in this way is restricted to a given geographic region or for use within a company. These items are either marked in the store by the retailer or are marked at the source by the supplier.

GS1 Member Organisations may assign one or several of the GS1 Prefixes 02, 20 through 29 for the identification of fixed measure trade items with RCN-13s, or RCN-12s for use within a given geographic region or for use within a company.

2.1.6.1 Company internal numbering – RCN-8 Prefix 0 or 2

Application description

This element string uses an RCN-8 Prefix of 0 or 2. It provides two million identification numbers, which can be assigned for internal use in a company. When the RCN-8 Prefix is 0, the element string is sometimes called a velocity code because it is quicker to key enter.

This element string is for internal use in a company. The numbers are assigned by individual companies and do not provide unique identification if they leave the company premises.

Figure 2.1.6.1-1. Data structure RCN-8 Prefix 0 or 2



RCN-8 Prefix	Item reference						Check digit
N ₁	N ₂	N ₃	N ₄	N ₅	N ₆	N ₇	N ₈

The RCN-8 Prefixes 0 or 2 are system identifiers that show that the item identification number is under the sole control of the assigning company and that it is for internal item distribution.

The item reference is allocated by the company that uses the element string. The positions N₂ to N₇ may contain any digit.

The check digit is explained in section [7.9](#). Its verification, carried out automatically by the barcode reader, ensures that the number is correctly composed.

The data transmitted from the barcode reader means that one fixed measure trade item with a GTIN-8 has been captured.

- 
Note: In addition to trade item identification, this element string may be used for any purpose that is supported by the company's equipment supplier.
- 
Note: In some environments where numbers may have to be key entered, the EAN-8 barcode carrying RCN-8s (and the RCN-8 Prefix 0) may be confused with the numbers carried by a UPC-E barcode. If such a risk exists, it is preferable to use the RCN-8 Prefix 2 capacity for internal use.

GS1 key

Definition

Not applicable

Rules

Not applicable

Attributes

Required

Not applicable

Optional

Not applicable

Rules

Not applicable

Data carrier specification

Carrier choices

The data carrier for this element string is the EAN-8 barcode. The system recognises this element string by the symbology identifier **JE4** and by N₁ being 0 or 2.

Symbol X-dimensions, minimum symbol height, and minimum symbol quality

See section [5.5.2.7.1](#), GS1 system symbol specification table 1.

Symbol placement

Not applicable

Unique application processing requirements

Not applicable

2.1.6.2 Company internal numbering – RCN-13 GS1 Prefix 04 (RCN-12 U.P.C. Prefix 4)

Application description

Any company in the world may use this element string for company internal trade item numbering. If the RCN-12 U.P.C. Prefix 4 is being applied, the user company may structure the trade item number.

Although this element string is mainly used for the identification of trade items, it may be used for any purpose as long as it is kept within a restricted environment. This element string is for a company's internal use. Because any company may use this element string, it does not provide unique identification of a trade item if it leaves the company's premises.

Figure 2.1.6.2-1. Data structure RCN-13 Prefix 04

GS1 Prefix	Item reference	Check digit
0 4	N ₃ N ₄ N ₅ N ₆ N ₇ N ₈ N ₉ N ₁₀ N ₁₁ N ₁₂	N ₁₃

The GS1 Prefix 04 is a system identifier showing that the identification number is under the sole control of the assigning company and that it is for internal trade item distribution.

The item reference is assigned by the company that uses the element string. Positions N₃ to N₁₂ may contain any digit.

The check digit is explained in section [7.9](#). Its verification, carried out automatically by the barcode reader, ensures that the number is correctly composed.

The data transmitted from the barcode reader means that one fixed measure trade item with a RCN-13 or RCN-12 has been captured.

GS1 key

Definition

Not applicable

Rules

Not applicable

Attributes

Required

Not applicable

Optional

Not applicable

Rules

Not applicable

Data carrier specification

Carrier choices

The data carriers for this element string are the EAN-13 and UPC-A barcodes.

The system recognises this element string by the symbology identifier **JE0**.

Symbol X-dimensions, minimum symbol height, and minimum symbol quality

See section [5.5.2.7.1](#), GS1 system symbol specification table 1.

Symbol placement

Not applicable

Unique application processing requirements

Not applicable

2.1.6.3 Company internal numbering – RCN-12 U.P.C. Prefix 0 (LAC and RZSC)

Application description

The U.P.C. Company Prefix 0 includes a reserved capacity for company internal numbering, using Local Assigned Codes (LACs) or Retailer Zero-Suppression Codes (RZSCs), which are carried by a UPC-E barcode. U.P.C. Company Prefixes 000000 and 001000 to 007999 are used in this feature. For details, see the figure below.

Although this element string is mainly used for the identification of trade items in restricted distribution, it may be used for any purpose as long as it is kept within a restricted environment.

This element string is for a company’s internal use. Because any company may use this element string, it does not provide unique identification of a trade item if it leaves the company’s premises.

Figure 2.1.6.3-1. UPC-E barcode option for the identification of GTINs for company internal distribution

GTIN-12 Identification Number of Trade Item												Check Digit	Represented in UPC-E Symbol Positions					
N ₁	N ₂	N ₃	N ₄	N ₅	N ₆	N ₇	N ₈	N ₉	N ₁₀	N ₁₁	N ₁₂	1	2	3	4	5	6	
(0)	0	0	1	0	0	0	0	0	0	0	5	2	0	1	0	0	0	'5'
(0)	0	0	7	9	9	9	0	0	0	0	9	7	0	7	9	9	9	'9'
LAC version = 35000 UPC-E Bar Code Applications																		
(0)	0	0	1	0	0	0	0	0	1	0	0	4	0	1	1	0	0	'0'
(0)	0	0	5	0	0	0	0	0	9	9	9	2	0	5	9	9	9	'0'
RZSC version = 4500 UPC-E Bar Code Applications																		
(0)	0	0	0	0	0	0	0	0	0	0	0	0	0	0	0	0	0	'0'
(0)	0	0	0	0	0	0	0	0	9	9	9	7	0	0	9	9	9	'0'
Velocity version = 1000 UPC-E Bar Code Applications																		

In figure 2.1.6.3-1, each number position must only contain the digits shown in the upper and lower lines of each section and those in-between. On decoding, the extension to full length is determined by the value of the number in single quotes in the column represented in UPC-E barcode positions.

The check digit, calculated as described in section 7.9, applies to the entire length of the RCN-12. In the UPC-E barcode, it is implicitly represented by the parity combination of the six symbol characters that are actually encoded. The check digit is explained in section 7.9. Its verification, carried out automatically by the barcode reader, ensures that the number is correctly composed

GS1 key

Definition

Not applicable

Rules

Not applicable

Attributes

Required

Not applicable

Optional

Not applicable

Rules

Not applicable

Data carrier specification

Carrier choices

The data carrier for this element string is the UPC-E barcode. The system recognises this element string by the symbology identifier **JE0** and GS1 Prefix 00 with the digits 01 to 07 in the next two positions.

Symbol X-dimensions, minimum symbol height, and minimum symbol quality

See section [5.5.2.7.1](#), GS1 system symbol specification table 1.

Symbol placement

Not applicable

Unique application processing requirements

It is possible to create a false UPC-E barcode if the encodation rules are not properly observed. Whether the digits represented in a UPC-E barcode can be expanded correctly to an RCN-12 may be verified by the tests shown in section [7.10](#).

2.1.6.4 GS1 Prefixes 02, 20 to 29 - Restricted Circulation

Application description

The GS1 Prefixes 02, 20 to 29 are reserved for identification purposes within a restricted geographic area. Each GS1 Member Organisation is entitled to assign the prefixes to be used for these element strings in its country or assigned area:

- for the identification of variable measure trade items or fixed measure trade items
- for internal numbering of variable measure trade items or fixed measure trade items by a particular company

 **Note:** Suppliers manufacturing their own label products for several different customers should use unique GS1 system numbering to distinguish their customers. If this is not done, the supplier will not be able to use Electronic Data Interchange (EDI) or electronic catalogues.

Although this element string is mainly used for the identification of trade items, it may be used for any purpose as long as it is kept within a restricted environment.

This element string is for use within a GS1 Member Organisation's geographic region. The GS1 Member Organisation may assign a company a GS1 Prefix for use externally throughout a region or may assign the prefix for use internally within a region. The numbers are never unique if they leave the region and, if assigned for a company's internal use, are not unique if they leave the company or region.

Figure 2.1.6.4-1. Format of the element string

GS1 Prefix	Item reference	Check digit
0 2	N ₃ N ₄ N ₅ N ₆ N ₇ N ₈ N ₉ N ₁₀ N ₁₁ N ₁₂	N ₁₃
2 N ₂	N ₃ N ₄ N ₅ N ₆ N ₇ N ₈ N ₉ N ₁₀ N ₁₁ N ₁₂	N ₁₃

The GS1 Prefix must be in the series 02, 20 to 29. A particular prefix may be assigned either for use on fixed measure trade items for restricted distribution or for variable measure trade items (see section [2.1.7](#)).

The item reference is assigned by the company that uses the element string. Positions N₃ to N₁₂ may contain any digit.

The check digit is explained in section [7.9](#). Its verification, carried out automatically by the barcode reader, ensures that the number is correctly composed.

The data transmitted from the barcode reader means that one fixed measure trade item with a RCN-13 or RCN-12 has been captured.

GS1 key

Definition

Not applicable

Rules

Not applicable

Attributes

Required

Not applicable

Optional

Not applicable

Rules

Not applicable

Data carrier specification

Carrier choices

The data carrier for this element string is an EAN-13 barcode.

The system recognises this element string by the symbology identifier **JE0** and the GS1 Prefix assigned by the relevant GS1 Member Organisation.

Symbol X-dimensions, minimum symbol height, and minimum symbol quality

See section [5.5.2.7.1](#), GS1 system symbol specification table 1.

Symbol placement

Not applicable

Unique application processing requirements

Not applicable

2.1.7 Variable measure trade items scanned in general retail at POS

This section describes applications for variable measure trade items that are scanned at point-of-sale. Two main applications exist:

- Variable measure fresh food trade items using a GTIN and additional attributes encoded with GS1 DataBar Expanded or Expanded Stacked. See section [2.1.7.1](#).
- Variable measure trade items using a Restricted Circulation Number (RCN) encoded with the EAN/UPC symbology family. See section [2.1.7.2](#).



Note: GTINs SHALL be encoded with AI (01). Restricted Circulation Numbers (RCNs) SHALL NOT be encoded with AI (01) as RCNs are not GTINs.

To support new applications additional GS1 approved data carriers (encoding additional data with the GTIN) may be applied with mutual agreement between trading partners. For information on how to manage multiple barcodes see section [4.15](#).

2.1.7.1 Variable measure fresh food trade items scanned in general retail at POS using GTIN

Application description

Like a fixed measure trade item, a variable measure trade item is an entity with predefined characteristics, such as the nature of the product or its contents. Unlike a fixed measure trade item, a variable measure trade item has one measure that varies continuously while other characteristics remain the same. In the case of fresh food trade items variable measure may be weight, length, number of items contained, or volume. There are different ways to handle the process for Variable measure fresh food. For example:

- Consumer puts loose produce items into a bag and barcoded label is produced and attached by the consumer.
- Staff attaches a barcode label, produced in store to pre-packed loose produce trade item.
- At the POS, loose produce is weighed and the price is calculated.

It is in the discretion of the retailer how the price is calculated and which process is chosen.

Variable measure fresh food

Variable measure loose produce trade items are trade items which may be identified with a GTIN and additional data. The retailer decides how to handle Variable measure fresh food trade items sold at POS. Generally the individual item(s) (i.e. loose produce) are put into a bag by the customer or by staff and are scanned (if a label is generated in store) or weighed at POS to generate the price. The attributes of variable measure trade items are barcoded when the trade item is weighed or measured in store. If the variable measure trade item is weighed at POS when presented to the cashier the price is generated in the register and directly added to the other products to complete the transaction.

Variable measure pre-packed fresh food trade items

These are Variable measure fresh foods trade items, either loose produce or cut from a bulk item, that are pre-packaged with differing weight or other variable measure using GTIN and attributes. The label put on the trade item encoding GTIN plus variable measure information and/or price is determined by the retailer.

GS1 key

Definition

- The GTIN-12 is the 12-digit GS1 identification key composed of a GS1 Company Prefix, item reference, and check digit used to identify trade items.
- The GTIN-13 is the 13-digit GS1 identification key composed of a GS1 Company Prefix, item reference, and check digit used to identify trade items.

Rules

All GTIN rules described in section 4.

Reference human readable interpretation rules in section 4.

Attributes

Required

See section [3.2](#), a variable count or a trade measure (AIs 30, 31nn, 32nn, 35nn, 36nn)

Optional

- See section [3.2](#) - GS1 Application Identifiers in numerical order for a complete list of all GS1 Application Identifiers.
- For more details related to GS1 Application Identifiers for fresh foods, refer to the Fresh Foods Implementation Guide.

Rules

For human readable interpretation rules see section [4.14](#).

Data carrier specification

Carrier choices

- GS1 DataBar Expanded
- GS1 DataBar Expanded Stacked



Note: The GS1 DataBar symbols encode a 14-digit numeric string. When encoding GTIN-12 or GTIN-13 in GS1 DataBar symbols, zero-fill with two or one zeros to the left of the GTIN.

Symbol X-dimensions, minimum symbol height, and minimum symbol quality

See section [5.5.2.7.1](#), GS1 system symbol specification table 1.

Symbol placement

None

Unique application processing requirements

None

2.1.7.2 Variable measure trade items scanned in general retail at POS using Restricted Circulation Numbers

Application description

Restricted circulation variable measure trade items are those sold in random quantity against a fixed price per unit quantity and intended to cross a point-of-sale (e.g., apples sold at a fixed price per kilogram). These items are either marked in the store by the retailer or are marked at the source by the supplier. National solutions are available for this purpose.

GS1 Member Organisations SHOULD assign one or several of the GS1 Prefixes 02, 20 through 29 for the identification of variable measure trade items in their territory. GS1 Member Organisations SHOULD make part of this capacity available to user companies for company internal applications.

The data fields available after the relevant GS1 Prefix (defined by the GS1 Member Organisation for their territory) can be structured in a variety of ways to represent the product type, net weight, calculated price, or number of units. Equipment is commercially available for automatically weighing items, calculating an item price from the unit price, and printing the information as a barcode label. The scanning equipment and applications can then be programmed to use the prefix as an instruction to decode the ensuing data fields according to the particular structure adopted.

The first row in the figure below shows the structure specified by GS1 US for North America. The same structure is used by many other GS1 Member Organisations. The next two rows do not show predetermined structures. Examples of recommended structures are given in figure 2.1.7.2-2. GS1 Member Organisations choose appropriate structures for use within their geographic area.

Figure 2.1.7.2-1. Format of the element string

GS1 Prefix	Item reference	Price verifier digit	Item price	Check digit
0 2	N ₃ N ₄ N ₅ N ₆ N ₇	N ₈	N ₉ N ₁₀ N ₁₁ N ₁₂	N ₁₃
0 2	N ₃ N ₄ N ₅ N ₆ N ₇ N ₈ N ₉	N ₁₀ N ₁₁ N ₁₂		N ₁₃
2 N ₂	N ₃ N ₄ N ₅ N ₆ N ₇ N ₈ N ₉	N ₁₀ N ₁₁ N ₁₂		N ₁₃

The item reference is usually assigned by the company that scans the element string at its point-of-sale. However, some countries may specify their own standard numbering systems for variable measure products administered by their GS1 Member Organisation or by a trade association.

The price verifier digit is the result of a special calculation, and its verification ensures correct reading of the price. For details, see section 7.9. Security of reading this element string without a price verifier digit depends on the element string’s check digit (see section 7.9).

The item price is the price of the trade item in the relevant currency with an implied decimal point defined by the trading partners or the relevant GS1 Member Organisation. A different format is required for each position of the implied decimal point. Multiple formats require an unambiguous way to differentiate each format, and separate GS1 Prefixes may be assigned to accomplish this.

The check digit is explained in section 7.9. Its verification, carried out automatically by the barcode reader, ensures that the data corresponds with the verification rules.

Figure 2.1.7.2-2. Examples of alternative data structures

Item reference	Price verifier digit	Item price
Item reference		Item price
Item reference	Measure verifier digit	Item measure
Item reference		Item measure

When the price (or weight) of an item is encoded using this element string, a price verifier digit or a measure verifier digit SHOULD be used. The measure verifier digit is calculated from the digits in the item measure field in the same way that the price verifier digit is calculated from the item price digits (see section 7).

The item measure is a measurement of the trade item with a defined unit of measure and an implied decimal point position. The unit of measure and decimal point position are defined within the relevant geographic area for each GS1 Prefix and/or format code. The item measure may be weight only if local weights and measures regulations permit.

The data transmitted from the barcode reader means that data about a variable measure trade item has been captured. The barcode reader normally performs the price verifier digit and the measure verifier digit calculation. Failing this, the calculation must take place in the application software.

Although each GS1 Member Organisation and/or user is free to develop a solution for numbering variable measure trade items, the GS1 system provides recommended structures that provide a degree of equipment standardisation. These formats may include an item reference, the retail price of the item, and a price check digit. The recommended structures are shown in the figure below.

Figure 2.1.7.2-3. Recommended data structures

GS1 Prefix	Recommended data structures (exact structure determined by GS1 Member Organisation)	Check digit
0 2	I I I I I V P P P P	C
or	I I I I V P P P P P	C
2 0 – 2 9	I I I I I I P P P P	C
	I I I I I P P P P P	C

The GS1 Prefix is administered by each GS1 Member Organisation and denotes the format and meaning of a particular element string, where:

- **I..I** = Item reference.
- **V** = Price check digit calculated according to the algorithm specified in section 7.
- **P..P** = Price in local currency.
- **C** = Check digit calculated according to the standard algorithm in section [7.9](#).

✓ **Note:** The price field may contain zero, one, or two implied decimal places depending on the monetary unit used. The decimal point, which is not included in the barcode, must nevertheless be taken into account by the marking equipment when printing the human readable interpretation on the label.

GS1 Member Organisations may choose to implement a national solution for variable measure trade items branded by the supplier for retail. Any national branded variable measure solution requires GS1 Member Organisations to manage the allocation of the item number at a national level.

GS1 key

Definition

Not applicable

Rules

Not applicable

Attributes

Required

Not applicable

Optional

Not applicable

Rules

Not applicable

Data carrier specification

Carrier choices

The data carriers for this element string are: UPC-A barcodes and EAN-13 barcodes.

The system recognises this element string by the symbology identifier **JE0**, the GS1 Prefix 02 or 20 to 29, and the structure defined by the GS1 Member Organisation in which it is operating.

Symbol X-dimensions, minimum symbol height, and minimum symbol quality

See section [5.5.2.7.1](#), GS1 system symbol specification table 1.

Symbol placement

Not applicable

Unique application processing requirements

Not applicable

2.1.8 Trade item extended packaging

The information obtained from a consumer trade item's packaging can be extended when consumers using mobile devices scan barcodes on the package, which leads them to more information or an

application. This standard provides a standardised packaging solution, which will lead to brand owner authorised information.

Independent of whether a trade item is retail or non-retail, fixed or variable measure, if it is sold to the end consumer and utilises GTIN-based identification, then it is within the scope of this application. GTIN is the primary GS1 key used to access GS1 B2C Trusted Source of Data infrastructure and all GS1 application standards for consumer trade items require GTIN, therefore this standard makes normative reference to the sections in the *GS1 General Specifications* related to consumer trade items in figure 2.1.8-1. In addition to using GTIN and indirect mode to reach trusted data, the URL AI (8200) with GTIN can be used to reach brand owner authorised information or applications via direct mode. GTIN and AI (8200) are encoded as separate data elements in the barcode but once decoded they are processed in a standard fashion by concatenating the following three strings: the contents of AI (8200), followed by a slash (/) character, followed by the GTIN expressed as 14 numeric digits. For example, where a trade item's GTIN, when expressed as 14 digits is 01234567890128 and the URL for direct mode access to information is <http://example.com/01234567890128>.

When encoded in the symbol, the sequence for encoding is (01) 01234567890128 (8200) <http://example.com>, but when processed the URL, a slash, and the GTIN are combined to arrive at <http://example.com/01234567890128>.

The example provided is not intended to constrain the brand owner to the use of http URL schema, the .com top-level domain, or the specific structure of URL illustrated. Any URL may be used, and in processing the slash character and 14-digit GTIN are appended.

These values are also expressed in non-HRI text on the label (see section 4.14, Rule 9). If GTIN attributes beyond AI (8200) are encoded together with GTIN and PRODUCT URL they are processed and expressed in text on the label as <http://brandownerassignedURL.com/gtin/serialnumber> where serial number equals up to 20 alphanumeric digits.

Figure 2.1.8-1. Overview of related normative sections

Section	Title	General retail POS	Regulated healthcare: retail POS	Regulated healthcare: non-retail / POC
2.1.2.1	General retail consumer trade items	Yes		
2.1.2.2	Loose produce trade items scanned at POS	Yes		
2.1.2.3	Trade items intended for general distribution and POS	Yes		
2.1.2.4	Healthcare primary packaging (non-retail trade items)			Yes
2.1.2.5	Healthcare secondary packaging (regulated healthcare retail consumer trade items)		Yes	
2.1.2.6.1	Trade items intended for general distribution scanning only / identification of a trade item that is a single product			Yes
2.1.7.1	Variable measure fresh food trade items scanned at point-of-sale using GTIN	Yes		

GS1 key

Definition

- For all applications above, GTIN-8 is the 8-digit GS1 identification key composed of a GS1-8 Prefix, item reference, and check digit used to identify trade items.
- For all applications above, GTIN-12 is the 12-digit GS1 identification key composed of a U.P.C. Company Prefix, item reference, and check digit used to identify trade items.
- For all applications above, GTIN-13 is the 13-digit GS1 identification key composed of a GS1 Company Prefix, item reference, and check digit used to identify trade items.

- For regulated healthcare non-retail applications above, GTIN-14 is the 14-digit GS1 identification key composed of an indicator digit (1-9), GS1 Company Prefix, item reference, and check digit used to identify trade items.

Rules

All existing rules in the sections, which appear in figure 2.1.8-1 apply as described in each section.

Attributes**Required**

Not applicable

Optional

For the purpose of indirect mode, all attributes in the sections which appear in the figure in section [2.1.8](#) apply as described in each section.

For the purpose of direct mode, AI (8200) must be used in combination with GTIN when brand owners provide extended packaging information or applications.

Rules

All rules in the sections which appear in the figure in section [2.1.8](#) apply as described in each section.

Data carrier specification**Carrier choices**

For the purpose of supporting indirect mode, all carrier choices in the sections which appear in the figure in section [2.1.8](#) apply as described in each section.

For the purpose of direct mode, in addition to the symbol required for indirect mode, when AI (8200) is used, GS1 DataMatrix and GS1 QR Code are the only approved data carriers. In the case of regulated healthcare consumer trade items, only GS1 DataMatrix is approved.

Symbol X-dimensions, minimum symbol height, and minimum symbol quality

To determine the appropriate specifications for printing and quality control, see the GS1 system symbol specification table(s) referred to in each Application Standard shown in the figure in section [2.1.8](#). See note below [Figure 5.5.2.7.1-2. GS1 system symbol specification table 1 addendum for AI \(8200\)](#) related to reverse and mirror-image representation constraint.

Symbol placement

None defined.

Unique application processing requirements

For a description of processing requirements, see section 7.

2.2 Logistic units

A logistic unit is an item of any composition established for transport and/or storage that needs to be managed through the supply chain.

Tracking and tracing logistic units in the supply chain is a major application of the GS1 system. Scanning the standard identification number, marked on each logistic unit, allows the physical movement of units to be individually tracked and traced by providing a link between the physical movement of items and the associated information flow. It also opens up the opportunity to implement a wide range of applications, such as cross docking, shipment routing, and automated receiving.

Logistic units are identified with a GS1 identification number called the SSCC (Serial Shipping Container Code). The SSCC is the only GS1 key that SHALL be used as the identifier of a logistic unit. The SSCC ensures that logistic units are identified with a number that is unique worldwide.

If, in addition to being a logistic unit, the item is regarded as a trade item by the brand owner, it may additionally be identified with a GTIN. The combination of a GTIN and a serial number must not replace the SSCC as the identifier of a logistic unit.

If, in addition to being a logistic unit, the item is part of a consignment and or a shipment, it may also be associated with the GINC and or the GSIN.

Attribute information, such as a Global Identification Number for Consignment, AI (401), may be optionally encoded using internationally agreed data structures and a barcode symbology that allow unambiguous interpretation.

2.2.1 Individual logistic units

Application description

A logistic unit is an item of any composition established for transport and/or storage that needs to be managed through the supply chain. The identification and symbol marking of logistic units enables a large number of user applications. In particular, the SSCC (Serial Shipping Container Code) provides a link between the physical logistic unit and information pertaining to the logistic unit that is communicated between trading partners using Electronic Data Interchange (EDI).

The SSCC element string AI (00) is used for the identification of logistic units (see section 3). Each individual logistic unit is allocated a unique number, which remains the same for the life of the logistic unit. When assigning an SSCC, the rule is that an individual SSCC number must not be reallocated within one year of the shipment date from the SSCC assignor to a trading partner. However, prevailing regulatory or industry organisation specific requirements may extend this period.

In principle, the SSCC provides a unique reference number that can be used as the key to access information regarding the logistic unit in computer files. However, attributes relating to the logistic unit (e.g., ship to information, logistic weights) are also available as standardised element strings.

GS1 key

Definition

The SSCC is the GS1 identification key used to identify logistics units. The key is comprised of an extension digit, the GS1 Company Prefix, serial reference, and check digit. The GS1 Application Identifier for the SSCC is AI (00), see section [3.2](#) for details of the SSCC and associated data elements.

Rules

All SSCC rules described in section 4.

Attributes

Required

Fixed measure AI (02) or routing code AI (403) are used when:

- A logistic unit is a grouping of trade items, it is sometimes useful to indicate the Global Trade Item Number (GTIN) of the contained items in association with the SSCC. See section [3.2](#),

Identification of trade items contained in a logistic unit - fixed measure, AI (02), and Count of trade items contained in a logistic unit, AI (37).

- Use of AI (02) and AI (37) with SSCC AI (00) is not the preferred option for regulated healthcare trade items. For regulated healthcare trade items, AI (02) + AI (37) is limited to bilateral use between trading partners for exception handling during a migration period to EDI implementation or if the product is sold as a non-regulated trade item within a retail distribution channel for certain markets. SSCC is the approach selected by healthcare and provides the appropriate level of identification when associated with EDI messaging to provide traceability inclusive of count for trade items contained. SSCC when associated with EDI is required for identification purposes to reach our extended goals for traceability.
- The routing code, AI (403), is assigned by a parcel carrier. It is intended to provide a migration path to the adoption of a yet to be defined international, multi-modal solution. See section [3.2](#), *Routing code, AI (403)*.

Optional

The use of attribute information on logistic units is optional. However, when used, attribute information SHOULD be processed with the SSCC that identifies the logistic unit.

- The element string *Ship to - Deliver to Global Location Number*, AI (410) has been designed to allow the automatic sortation of logistic units using the Global Location Number (GLN).
- The element string *Ship for - Deliver for - Forward to Global Location Number*: AI (413), has been designed to allow the cross docking of logistic units using the Global Location Number (GLN). It is used in conjunction with the element string AI (410) to indicate the cross docking station and the final destination of the logistic unit.
- The element string *Ship to - Deliver to Postal Code within a Single Postal Authority*, AI (420) has been designed to allow the automatic sortation of logistic units using the postal code in a single postal area.
- The element string *Ship to - Deliver to Postal Code with Three-Digit ISO Country Code*, AI (421) has been designed to allow the automatic sortation of logistic units using the postal code. As the postal code is prefixed by the ISO country code, it may be used internationally.

See section [3.2](#) for more details and the list of all GS1 Application Identifiers.

Rules

Refer to section 4 for the mandatory associations.

Data carrier specification

Carrier choices

The mandatory data carrier used to represent GS1 system individual logistic units is the GS1-128 barcode symbology.

For healthcare, see the “Data Carrier Specification Carrier Choices” recommendations on *Options in Addition to the barcode* at the end of section [2.1.2.4](#) in figure 2.1.2.4-2 Carrier choices.

Symbol X-dimensions, minimum symbol height, and minimum symbol quality

See section [5.5.2.7.5](#), GS1 system symbol specification table 5.

Symbol placement

All the symbol placement guidelines defined in section 6.

Unique application processing requirements

For a description of processing requirements, see section 7.

2.2.2 Multiple logistic units – Global Identification Number for Consignment

Application description

- Consignments can comprise one or many logistic units. If the consignment comprises more than one physical object there is no requirement that they are attached together. A consignment number identifies a logical grouping. When a consignment number is read the message is that this physical unit should be associated with any other physical units carrying the same consignment number. Individual physical units carry the SSCC as described in the previous section.
- The Global Identification Number for Consignment is assigned by the freight forwarder or carrier of the transport units and is referenced in the relevant transport messages and documents (e.g. waybill). It may be used as a communication reference by all parties in the transport chain, such as in Electronic Data Interchange (EDI) messages where it can be used as a consignment reference and/or freight forwarders or carriers loading list. See section [3.2](#), Global Identification Number for Consignment (GINC): AI (401).



Note: Shipment and consignment are terms, which may be used interchangeably within the transport and logistics sector however for the purposes of clarity, when referring to multiple logistic unit identification for trade, GS1 uses the term shipment and when referring to multiple logistic unit identification for transport, GS1 uses the term consignment

GS1 key

Definition

The Global Identification Number for Consignment, AI (401), identifies a logical grouping of goods (one or more physical entities) that has been consigned to a freight forwarder or carrier and is intended to be transported as a whole. Refer to section [3.2](#) for the list of GS1 Application Identifiers with detailed information.

Rules

The data transmitted means that the element string denoting a Global Identification Number for Consignment has been captured. The Global Identification Number for Consignment may be processed as stand-alone information where applicable or with other identification data appearing on the same unit. See section [4.9](#).

Attributes

Required

Not applicable

Optional

Not applicable

Data carrier specification

Carrier choices

The data carrier used to represent the GS1 Global Identification Number for Consignment is the GS1-128 barcode symbology.

Symbol X-dimensions, minimum symbol height, and minimum symbol quality

See section [5.5.2.7.2](#), GS1 system symbol specification table 2.

Symbol placement

All the symbol placement guidelines defined in section 6.

Unique application processing requirements

For a description of processing requirements, see section 7.

2.2.3 Multiple logistic units – Global Shipment Identification Number

Application description

- Shipments can comprise one or many logistic units. If the shipment comprises more than one physical object there is no requirement that they are attached together. A shipment number identifies a logical grouping. When a shipment number is read the message is that this physical unit should be associated with any other physical units carrying the same shipment number. Individual physical units carry the SSCC as described in the previous section.
- The Global Shipment Identification Number is assigned by a seller (sender) of the goods and is referenced in the despatch advice and bill of lading, etc. It is a globally unique number that identifies a logical grouping of physical units in a transport shipment. It may be used as a communication reference by all parties in the transport chain, such as in Electronic Data Interchange (EDI) messages where it can be used as a shipment reference and/or a consignor's loading list.
- Note: Shipment and consignment are terms which may be used interchangeably within the transport and logistics sector, however for the purposes of clarity, when referring to multiple logistic unit identification for trade, GS1 uses the term shipment and when referring to multiple logistic unit identification for transport, GS1 uses the term consignment.

GS1 key

Definition

The Global Shipment Identification Number (bill of lading) is a number assigned by a seller (sender) of the goods. It provides a globally unique number that identifies a logical grouping of physical units for the purpose of a transport shipment. The GS1 Application Identifier for the GSIN is AI (402), see section [3.2](#).

Rules

The data transmitted means that the element string denoting a shipment identification number has been captured. The Global Shipment Identification Number may be processed as stand-alone information where applicable or with other identification data appearing on the same unit.

See section [4.10](#).

Attributes

Required

Not applicable

Optional

Not applicable

Data carrier specification

Carrier choices

The data carrier used to represent GS1 Global Shipment Identification Number is the GS1-128 barcode symbology.

Symbol X-dimensions, minimum symbol height, and minimum symbol quality

See section [5.5.2.7.2](#), GS1 system symbol specification table 2.

Symbol placement

All the symbol placement guidelines defined in section 6.

Unique application processing requirements

For a description of processing requirements, see section 7.

2.3 Assets

The GS1 system provides a method for the identification of assets. The object of asset identification is to identify a physical entity as an inventory item. Each company holding a GS1 Company Prefix may assign asset identifiers to the assets or trade items supplied to their customers.

Each company holding a GS1 Company Prefix may assign a Global Returnable Asset Identifier (GRAI) or Global Individual Asset Identifier (GIAI). If the asset is manufactured on behalf of a company best practice may dictate that the manufacturing company applies the GRAI or GIAI during the manufacturing process on behalf of this customer.

- ✔ **Note:** Where assets of the same type need to be ordered a GTIN is required for the ordering process. There is no conflict when a GTIN and a GRAI (GS1 Company Prefix, asset type and check digit) have the same digits, because the data carrier (EDI qualifier, GS1 barcode with GS1 Application Identifier, or EPC/RFID) will distinguish between the two GS1 identification keys.

The GS1 asset identifiers act as keys to access the characteristics of an asset stored in a computer file and/or to record movements of assets.

- ✔ **Note:** The attributes of the asset should be recorded and shared digitally using the GS1 asset identifier as the key to the information. Examples of the type of information held include the party who owns the asset, the value of the asset, the location of the asset, and the life-cycle history of the asset.

Asset identifiers may be used for applications, such as the location and usership of a given asset (e.g., a personal computer or returnable transport item) or for complex applications, such as recording the characteristics of a returnable asset (e.g., a reusable beer keg), its movements, its life-cycle history, and any relevant data for accounting purposes.

2.3.1 Global Returnable Asset Identifier (GRAI): AI (8003)

Application description

A returnable asset is a reusable package or transport equipment of a certain value, such as a beer keg, a gas cylinder, a plastic pallet, or a crate. The GS1 system identification of a returnable asset, the Global Returnable Asset Identifier (GRAI), enables tracking as well as recording of all relevant data.

The element string comprises the GRAI. The GRAI is composed of the GS1 Company Prefix of the company assigning the asset identifier and of the asset type. The latter is assigned to uniquely identify, together with the GS1 Company Prefix, a particular kind of asset. The GRAI remains the same for all identical Returnable Assets. Although consecutive numbering is recommended, the structure is left to the discretion of the assigning company. An optional serial component may be used to distinguish Individual Assets within a given asset type.

A typical application using this element string is in tracking returnable beer kegs. The owner of the beer keg applies a barcode carrying a GRAI to the keg using a permanent marking technique. This barcode is scanned whenever the keg is supplied full to a customer and scanned again when it is returned. This scanning operation allows the beer keg owner to automatically capture the life-cycle history of a given keg and to operate a deposit system, if desired.

- ✔ **Note:** This element string identifies a physical entity as a returnable asset. When such a physical entity is used to transport or to contain a trade item, the element string AI (8003) must never be used to identify the transported or contained trade item.

GS1 refers to GRAI in the section [2.1.2.7](#), which deals with medical devices for the Automatic Identification and Data Capture (AIDC) management of these items within the micro-logistics cycle of use, cleaning and sterilisation. See section [2.1.2.7](#) for more details.

GS1 key

Definition

The Global Returnable Asset Identifier (GRAI) is the GS1 identification key used to identify returnable assets. The key is comprised of a GS1 Company Prefix, asset type, check digit, and optional serial component.

The structure of the element string for a GRAI can include two parts: the mandatory asset type identification and an optional serial component.

The GS1 Application Identifier to indicate the Global Returnable Asset Identifier (GRAI) is AI (8003). See section [3.2](#) for the list of all GS1 Application Identifiers.

Rules

See section 4, Application rules.

Attributes

Required

Not applicable.

Optional

Not applicable.

Rules

See section 4, Application rules.

Data carrier specification

Carrier choices

The GS1 data carriers that can be used to represent the GRAI are:

- GS1-128.
- GS1 DataMatrix.
- GS1 QR Code.
- EPC/RFID.

When encoding an asset identifier for medical devices see section [2.1.2.7](#).

When applying direct part marking, also see the information in section [2.1.4](#).

Symbol X-dimension, minimum symbol height, and minimum symbol quality

For GS1-128, GS1 DataMatrix and GS1 QR Code, see section [5.5.2.7.9](#) GS1 system symbol specification table 9 and section [5.5.2.7.7](#) GS1 system symbol specification table 7 (direct part marking).

Symbol placement

Not applicable.

Unique application processing requirements

For a description of processing requirements, see section 7.

2.3.2 Global Individual Asset Identifier (GIAI): AI (8004)

Application description

In the GS1 system, an individual asset is considered a physical entity made up of any characteristics.

This element string identifies a particular physical entity as an asset. It must not be used for other purposes and must be unique for a period well beyond the lifetime of the relevant asset records. Whether or not the assigned Global Individual Asset Identifier (GIAI) may remain with the asset when changing hands depends on the particular business application. If it remains with the asset it SHALL never be reused.

The GIAI comprises the GS1 Company Prefix of the company assigning the asset identifier and an individual asset reference (see section 3). The individual asset reference is alphanumeric. Its structure is left to the discretion of the asset owner or manager.

This element string might, for example, be used to record the life-cycle history of aircraft parts. By symbol marking the GIAI, AI (8004), on a given part, aircraft operators are able to automatically update their inventory database and track assets from acquisition until retirement.

GS1 refers to GIAI in the section [2.1.2.7](#), which deals with Automatic Identification and Data Capture (AIDC) for medical devices within the micro-logistics cycle of use, cleaning and sterilisation. See section [2.1.2.7](#) for more details.

GS1 key

Definition

The Global Individual Asset Identifier (GIAI) is the GS1 identification key used to identify an individual asset. The key is comprised of a GS1 Company Prefix and an individual asset reference.

The GS1 Application Identifier to indicate the Global Individual Asset Identifier (GIAI) is AI (8004). See section [3.2](#) for the list of all GS1 Application Identifiers.

 **Note:** The GIAI of assemblies (composite components) may need to be marked on a component of the assembly (the so called leading part) when there is no dedicated space to mark the GIAI on the assembly itself. For example, the GIAI of a *side buffer* of a rail vehicle may be included in a separate marking on the *buffer casing*, in addition to the marking of the *buffer casing* itself. To be able to recognise the marking of the assembly AI (7023) SHALL be used to indicate the GIAI of the assembly.

Figure 2.3.2-1. Example: Side buffer (assembly) with buffer casing (leading part)



Rules

See section 4, Application rules.

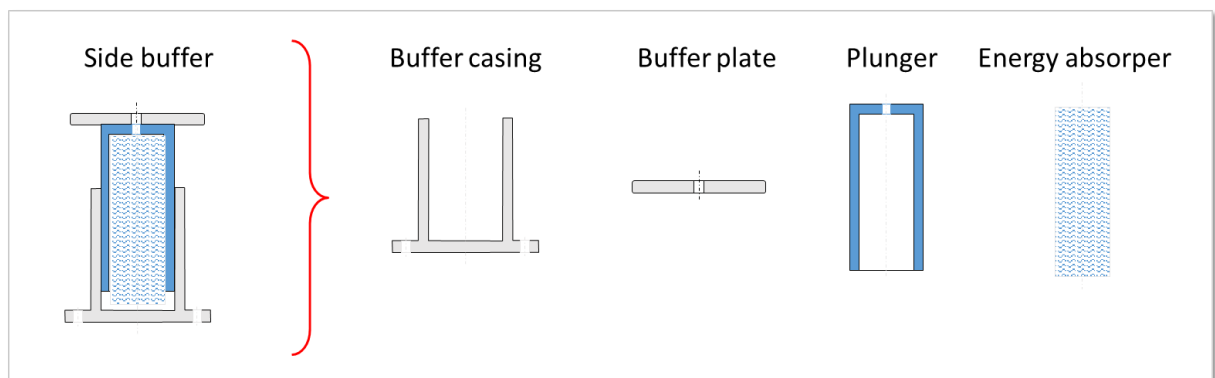
Attributes

Required

Not applicable

Optional

Not applicable

Rules

See section 4, Application rules (none is currently identified).

Data carrier specification

Carrier choices

The GS1 data carriers that can be used to represent the GIAI are:

- GS1-128.
- GS1 DataMatrix.
- GS1 QR Code.
- EPC/RFID.

When encoding an asset identifier for medical devices see section [2.1.2.7](#).

When applying direct part marking, also see the information in section [2.1.4](#).

Symbol X-dimension, minimum symbol height, and minimum symbol quality

For GS1-128, GS1 DataMatrix and GS1 QR Code, see section [5.5.2.7.9](#) GS1 system symbol specification table 9 and section [5.5.2.7.7](#) GS1 system symbol specification table 7 (direct part marking).

Symbol placement

Not applicable

Unique application processing requirements

For a description of processing requirements, see section 7.

2.4 Locations and parties

The Global Location Number (GLN) provides a unique and unambiguous identification of:

1. Physical Locations - A site (an area, a structure or group of structures) or an area within the site where something was, is, or will be located.

The identification of physical locations is an essential element for supply chain visibility. A GLN assigned to a physical location always has a permanent and identifiable geographical address regardless of any business process roles conducted at the site.

2. Digital Locations - A digital location represents an electronic (non-physical) address that is used for communication between computer systems.

Just as the exchange of physical goods is a transaction between companies, the exchange of data is a transaction between systems, for example the delivery of an invoice by EDI or email to an accounting system.

3. Legal Entities – Any business, government body, department, charity, individual or institution that has standing in the eyes of the law and has the capacity to enter into agreements or contracts.

4. Functions – An organisational subdivision or department based on the specific tasks being performed, as defined by the organisation.

Legal entities and functions can engage as **parties** in business processes. The use of Global Location Numbers (GLNs) in these areas is driven by the exact role of each party within a given business process.

2.4.1 GLN definition

The GLN enables the unique and unambiguous identification of any type of location used in business processes. Identification in this manner is a prerequisite for efficient communication between trading partners. A GLN acts as a database key which references location specific information that is repeatedly applied. Its function is to reduce input errors and increase efficiency.

Each company or organisation that is a member of a GS1 Member Organisation may use GLNs to identify locations under the terms of its membership. Contact details for all GS1 Member Organisations are available on the GS1 website, www.gs1.org.

In some countries, GS1 Member Organisations administer national GLN databases, known as GLN registries, provide a common list of GLNs registered within that country. However, the company issuing these GLNs is responsible for keeping business partners informed of all GLNs related to the trading relationship. Special care is needed if company ownership or structure changes (see section [1.6](#)).

In business operations, location numbers are of no value if they are not associated with business attributes. The attributes of the location ideally should be established as part of master data management using the GLN as the key to the information.

For rules on GLN allocation, see section 4.

2.4.2 GLN in electronic data sharing standards

The GLN is widely used in the sharing of electronic data between companies, since it enables unambiguous identification of the parties, locations and systems. Therefore the GLN is a foundational key in the related GS1 standards.



Note: The *GS1 General Specifications* provides a high level overview of the electronic data sharing standards and applications. For further information, please consult the relevant GS1 standard.

EDI

Electronic Data Interchange (EDI) ideally uses Global Location Numbers (GLNs) to identify all trading partners and physical locations involved. Also the EDI mailbox or network address for

companies is often identified with a GLN. The EDI standards promoted by the GS1 system (EANCOM, GS1 XML) make full use of GLNs to simplify the automation of business messaging.

GLNs and associated information of trading partners are communicated at the start of the relation through the party information message (PARTIN). GLNs are then used during the trading relationship in any other business message, such as invoice, order, pay, or deliver.

GDSN

Data pools and the GS1 Global Registry that links them for the purpose of global data synchronisation mandate the use of GLNs to identify each party that provides information to any data pool or who requires information about products and locations.



Note: The *GS1 General Specifications* do not provide details on business messages or the Global Data Synchronisation Network (GDSN). For further information, please consult the relevant GS1 standard.

EPCIS

Electronic Product Code Information Services (EPCIS) is a GS1 Standard that defines a common data model for visibility data and interfaces for capturing and sharing visibility data within an enterprise and across an open supply chain. GS1 EPCIS implementations use the GLN to identify Read Points and Business Locations. A Read Point indicates the specific location at which an event took place, and thereby the whereabouts of objects at the time of a given event. A Business Location indicates the specific place of objects following a given event.

2.4.3 Application overview

The GLN is used in applications that cover the electronic sharing of location information and the automatic identification and data capture (AIDC). The following applications focus on the use of the GLN in AIDC applications. Three broad categories of use of the GLN exist:

1. Identification of a physical location, for example through a label attached to a loading dock or to a shelf location in a warehouse.
2. Specification of a delivery location, for example a ship to location on a logistics label.
3. Specification of a party, for example the invoicing party on a payment slip.

2.4.3.1 Identification of a physical location

Application description

The following GS1 Application Identifiers enable the identification of a physical location using a data carrier present at the location itself:

- AI (414) Physical Location
- AI (254) GLN extension component

AI (414) Physical location

The GLN can be used to identify a physical location represented in a data carrier on the location itself. Physical locations may, for example, be a room, a door of a warehouse, an x-ray room in a hospital, or a control point.

The element string may be used to record and confirm presence at a given location for any purpose. An equivalent field will hold this information in electronic messages.

AI (254) GLN extension component

Business processes causes objects (products, assets, or other equipment) to move from one physical location to another. The ability to have visibility of these movements is an essential element in any supply chain. These physical locations can be a site such as a distribution centre or a specific location within the site such as a selling floor, a room in a hospital or a yard of a warehouse; it can even be as granular as a specific area on a shelf.

The GLN extension component may be used to identify internal physical locations within a location identified with a GLN (e.g., stores, factories, buildings). A company may alternatively choose to assign a unique GLN, without an extension component, as a way to identify these locations.

The following figure illustrates just one likely example; it is not the only normative solution.

Figure 2.4.3.1-1. Physical locations in a logistic process

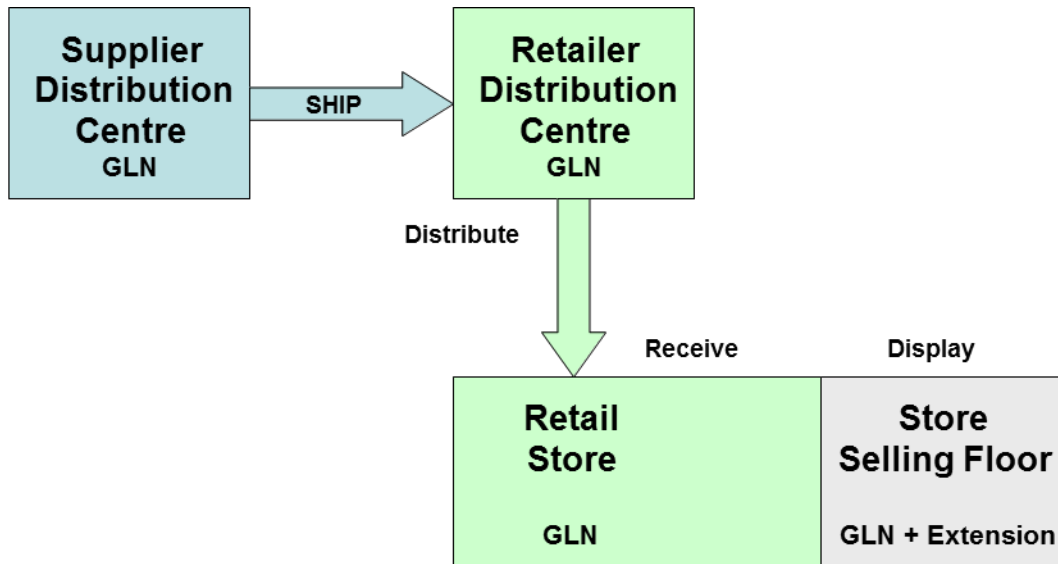

Important:

- The use of GLN + GLN extension component is restricted to physical locations.
- The GLN extension component may be communicated to trading partners, by mutual agreement.
- If the GLN + GLN extension component are used to identify locations within the site, each sub-location identification SHALL follow the same allocation rules defined for the physical location GLN, see section 4.

GS1 key

Definition

The Global Location Number (GLN) is the GS1 identification key used to identify physical locations or parties. The key is comprised of a GS1 Company Prefix, location reference, and check digit.

Identification of a Physical Location - Global Location Number: AI (414)

Rules

All GLN Allocation Rules described in section 4.

Attributes

Required

Not applicable

Optional

The extension component may be used to identify internal physical locations within a location identified with a GLN (e.g., stores, factories, buildings). The use of GLN extension component is restricted to physical locations.

The GLN extension component may be communicated to trading partners, by mutual agreement.

The GS1 Application Identifier (254) is used to represent the GLN extension component in conjunction with AI (414).

For more information, see section [3.2](#) for the list of GS1 Application Identifiers.

Rules

See section 4, Mandatory association of element strings.

Data carrier specification

Carrier choices

The GS1 data carriers that can be used to represent the GLN or GLN + GLN extension component are:

- GS1-128
- GS1 DataMatrix
- GS1 QR Code
- EPC/RFID



Note: GS1's *EPC Tag Data Standard* (TDS) defines the SGLN as a Global Location Number (GLN), with or without the optional extension (AI 254), which is used to identify physical locations. Examples of such locations include a specific building or unit of shelving within a warehouse. For more information on EPC carriers see the *EPC Tag Data Standard*

Symbol X-dimension, minimum symbol height, and minimum symbol quality

See section [5.5.2.7.9](#), GS1 system symbol specification table 9.



Note: For location marking barcodes may be printed at a higher maximum X-dimension: GS1-128 at 1.016 mm (0.0400 inches), GS1 DataMatrix and GS1 QR Code at 1.520 mm (0.0600 inches).

Symbol placement

Not applicable

Unique application processing requirements

For a description of processing requirements, see section 7.

2.4.3.2 Specification of a physical location

Application description

The following GS1 Application Identifiers enable the specification of a physical location on a label or document, relative to its role in a business process:

- AI (410) Ship to - Deliver to.
- AI (413) Ship for - Deliver for.
- AI (416) Production or service location

AI (410) Ship to - Deliver to

An element string with GS1 Application Identifier AI (410) represents the Global Location Number (GLN) of the recipient of a logistic unit. The GLN refers to the address where a particular transport unit identified with an SSCC is to be delivered. This element string is used in single leg transport operations. A logistic unit may include a barcode carrying the GLN of the unit's intended destination. When scanning this element string, the data transmitted may be used to retrieve the related address and/or to sort the item by destination.

AI (413) Ship for - Deliver for

An element string with GS1 Application Identifier AI (413) is used by the consignee for determining the internal or subsequent final destination of a physical unit.

Cross docking is a typical application using this element string. Here, a barcode carrying the element string AI (410) is placed on a logistic unit at the point of creation to direct the goods to the intermediate destination (e.g., a distribution centre). The element string AI (413) is also carried by the barcode to direct the goods to their final destination (e.g., a retail store served by the distribution centre).

Figure 2.4.3.2-1. Example of a cross docking application

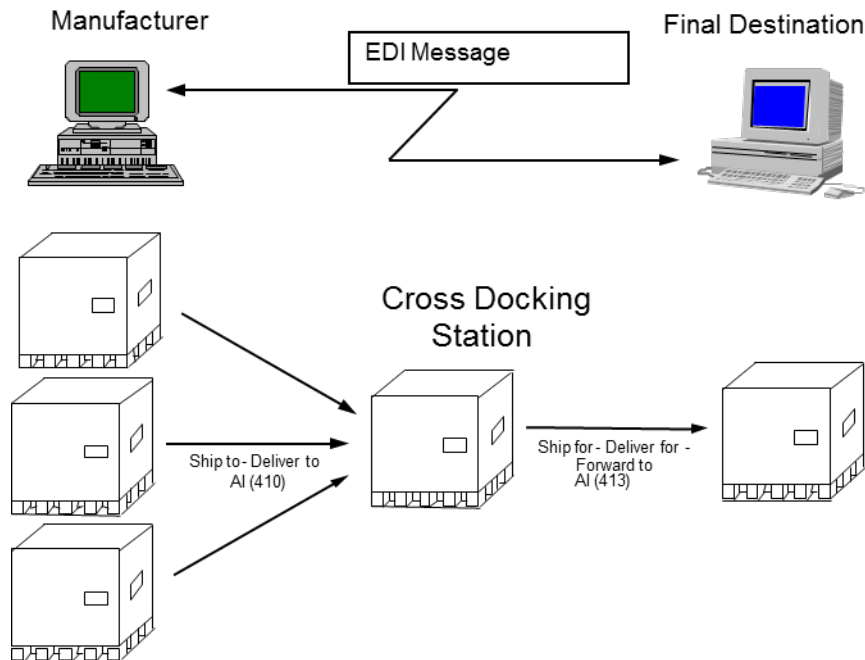

AI (416) GLN of the production or service location

An element string with a GS1 Application Identifier AI (416) represents the Global Location Number (GLN) of the production or service location. It may for example be used to specify the location where a trade item or asset was produced or refurbished.

GS1 key

Definition

The Global Location Number (GLN) is the GS1 identification key used to identify physical locations or parties. The key is comprised of a GS1 Company Prefix, location reference, and check digit.

Rules

All GLN Allocation Rules described in section 4.

Attributes

Required

Not applicable

Optional

Not applicable

Rules

Not applicable

Data carrier specification

If the GLN is carried in a barcode or EPC/RFID tag on a product, the rules for trade item applications apply, see section [2.1](#).

If the GLN is carried in a barcode on a GS1 Logistics Label, the rules for logistic unit applications apply, see section [2.2](#).

Unique application processing requirements

For a description of processing requirements, see section 7.

2.4.3.3 Specification of a party

Application description

The following GS1 Application Identifiers enable the specification of a party on a label or document, relative to its role in a business process:

- AI (411) Bill to - Invoice to.
- AI (412) Purchased From.
- AI (415) Invoicing Party.
- AI (703*) Approval Number of processor (with ISO country code '999').

AI (411) Bill to – Invoice to

An element string with GS1 Application Identifier AI (411) represents the Global Location Number (GLN) of the addressee of an invoice. The GLN refers to the name and address of the business partner to which an entity shall be invoiced and includes accounting-related information that may be used wherever required.

AI (412) Purchased from

In business it is sometimes important to know from where a particular item was purchased. Applied on a trade item, an element string with GS1 Application Identifier AI (412) provides the Global Location Number (GLN) of the company from which the respective trade item has been purchased.

AI (415) Invoicing party

An element string with GS1 Application Identifier AI (415) is used to indicate the Global Location Number (GLN) of the invoicing party. The GLN is mandatory information for the payment slip application (see section [2.6.6](#)).

AI (703*) Number of processor

An element string with GS1 Application Identifier (703s) represents the ISO country code and approval number or GLN of the processor of a trade item. If '999' is entered as the ISO country code it signifies that the subsequent data is a Global Location Number (GLN), and not an 'approval number'.

As an attribute of a trade item the number of processor must be processed together with the GTIN of the trade item to which it relates. See section [3.8.16](#) for more information.

GS1 key

Definition

The Global Location Number (GLN) is the GS1 identification key used to identify physical locations or parties. The key is comprised of a GS1 Company Prefix, location reference, and check digit.

Rules

All GLN Allocation Rules described in section 4.

Attributes

Required

Not applicable

Optional

Not applicable

Rules

Not applicable

Data carrier specification

If the GLN is carried in a barcode on a product, the rules for trade item applications apply, see section [2.1](#).

If the GLN is carried in a barcode on a GS1 Logistics Label, the rules for logistic unit applications apply, see section [2.2](#).

If the GLN is carried in a barcode on a payment slip the rules for the payment slips application apply, see section [2.6.6](#).

Unique application processing requirements

For a description of processing requirements, see section 7.

2.5 Service relationships

Application description

The Global Service Relation Number (GSRN) is a non-significant number used to identify the relationship between an organisation offering services and the individual entities providing or benefitting from the services. The GSRN provides unique and unambiguous identification. It is the key to accessing information, stored on computer systems, relevant to service(s) provided and received and in some cases, these services could be recurring. The GSRN may also be used for referencing information transferred via Electronic Data Interchange (EDI).

When using the GSRN, often two types of relationships may need to be captured in one transaction:

1. The relationship between the organisation offering the service and the actual recipient of the service.
2. The relationship between the organisation offering the service and the actual provider of the service.

It should be noted that the GSRN is not meant to identify a single service as a trade item, neither is it used to identify a physical unit as a trade item. It may identify a physical unit for service purposes (e.g., a computer with a service agreement).

2.5.1 Global Service Relation Number – Provider: AI (8017)

An element string with GS1 Application Identifier AI (8017) represents the Global Service Relation Number of a relationship between the organisation offering the service and the provider of the service. Some examples of how the GSRN can be used to identify the service relationships are:

- A medical procedure, where it could be used to identify an individual medical provider by role. For identification of the individual provider of care, the hospital or the appropriate authority generates a GSRN with AI (8017) for each of its caregivers and encodes it in an appropriate GS1 Data carrier (barcode) symbol on the caregiver's ID card, work station, work order, etc. In this case, the GSRN would ensure non-significant identification management, securing identification uniqueness and also allowing linkage to local rule management systems.
- A service agreement, where it could be used to manage agreed upon services, such as maintenance services for a television or computer.
- A loyalty program required to identify the service relationship between the loyalty program and the service provider (i.e. company providing merchandise due to use of loyalty points).
- A hospital administration can identify the service relationship between hospital and the doctor, nurses, etc.

GS1 key

Definition

The Global Service Relation Number is the GS1 identification key used to identify the relationship between an organisation offering services and the recipient or provider of services. The key is comprised of a GS1 Company Prefix, service reference and check digit.

See section [3.2](#), *Global Service Relation Number AI (8017) and AI (8018)* for the definition of the GS1 Application Identifier.

Rules

See section [4.2.5](#), GSRN rules.

Attributes

Required

Not applicable

Optional

GS1 Application Identifier AI (8019) Service Relation Instance Number, section [3.2](#)

Rules

Not applicable

Data carrier specification**Carrier choices**

The data carriers for the Global Service Relation Number (GSRN) are the GS1-128, GS1 DataMatrix and GS1 QR Code symbologies.

Symbol X-dimension, minimum symbol height, and minimum symbol quality

See section [5.5.2.7.11](#), GS1 system symbol specification table 11

Symbol placement

No standard placement is required.

Unique application processing requirements

For a description of processing requirements, see section 7.

2.5.2 Global Service Relation Number – Recipient: AI (8018)

An element string with GS1 Application Identifier AI (8018) represents the Global Service Relation Number of a relationship between the organisation offering the service and the recipient of the service. Some examples of how the GSRN can be used to identify the service relationships are:

- A hospital admission, where it could be used to identify a subject of care globally and uniquely for AIDC purposes and establish an identification uniqueness that does not harm privacy. For identification of the subject of care (patient) the hospital generates a GSRN with AI (8018) for each of its patients and encodes it in an appropriate GS1 Data carrier (barcode) on the patient's wristband as well as his or her corresponding medical record, pathology samples, etc. The GSRN may then be used as the key to link multiple or specific instances of treatment, room charges, medical tests, and patient charges.
- A membership in a frequent flyer programme, where it could be used to record awards, claims, and preferences.
- A membership in a loyalty scheme, where it could be used to record visits, purchase value, and awards.
- A membership in a club, where it could be used for recording entitlements, use of facilities, and subscriptions.
- A loyalty program required to identify the service relationship between the loyalty program and the recipient of the loyalty program (the end user or customer who earns loyalty points).
- Patient admission to a hospital can identify the service relationship between the hospital and the patient.
- Utility networks, such as those providing electricity, gas or water, where it could be used to identify the relationship between network service providers and suppliers of utility products.
- A GSRN could be used to give students access to other libraries that have formed a cooperative lending agreement. A typical application is the identification of membership in a student library. The library would issue all members a card that includes a unique GSRN identifying the relationship between the library and a student. The library would then scan the GSRN whenever a book was lent or returned. The Electronic Message from the scanner would then be used to automatically update the library's stock management database. See the figure below for an example of how the service relationship identifier would appear on this membership card.

Figure 2.5.2-1. Example of GSRN on a membership card

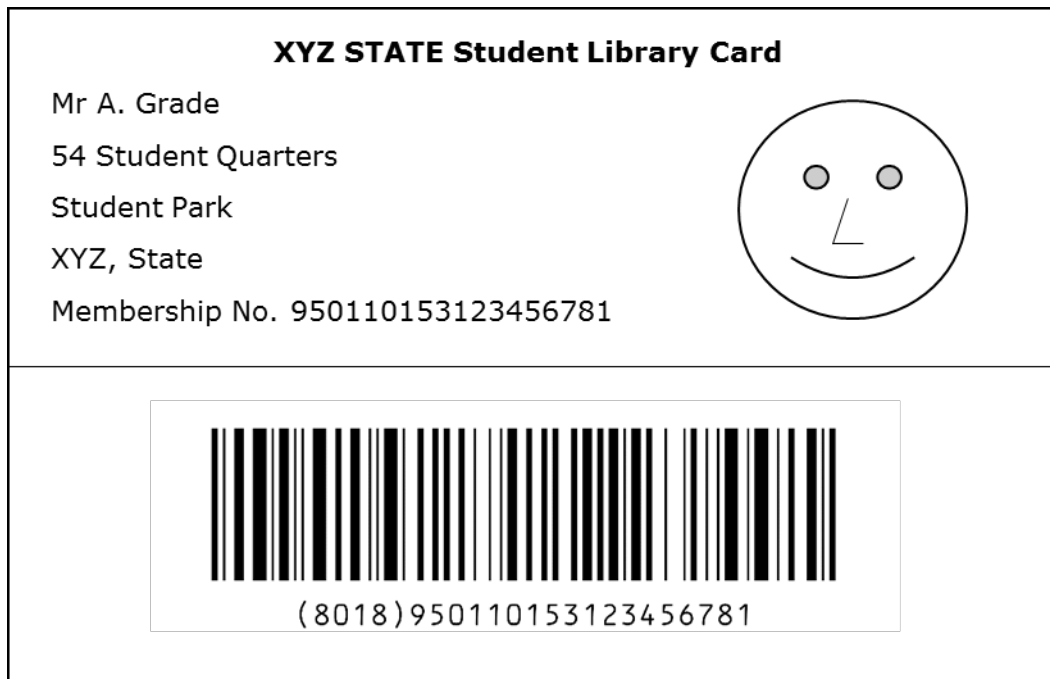

GS1 key

Definition

The Global Service Relation Number is the GS1 identification key used to identify the relationship between an organisation offering services and the recipient or provider of services. The key is comprised of a GS1 Company Prefix, service reference and check digit.

See section [3.2](#), *Global Service Relation Number AI (8017) and AI (8018)* for the definition of the GS1 Application Identifier.

Rules

See section [4.2.5](#), GSRN rules.

Attributes

Required

Not applicable

Optional

GS1 Application Identifier AI (8019) Service Relation Instance Number, section [3.2](#).

Rules

Not applicable

Data carrier specification

Carrier choices

The data carriers for the Global Service Relation Number (GSRN) are the GS1-128, GS1 DataMatrix and GS1 QR Code symbologies.

Symbol X-dimension, minimum symbol height, and minimum symbol quality

See section [5.5.2.7.11](#), GS1 system symbol specification table 11

Symbol placement

No standard placement is required.

Unique application processing requirements

For a description of processing requirements, see section 7.

2.5.3 Service Relation Instance Number: AI (8019)

When a product or service is administered (e.g., a particular treatment is given) it can easily be associated with the patient by scanning the Global Trade Item Number (GTIN) of the product or service as well as the caregiver's GSRN (barcoded with AI (8017)) and the patient's GSRN (barcoded with AI (8018)). If the subject of care identification needs to, optionally, be made more granular with a sequence indicator corresponding to each encounter during the episode of care, attribute data in the form of a Service Relation Instance Number (GS1 Application Identifier AI (8019), see section [3.2](#)) may be added. This would, for example, allow differentiation of subject of care identification captured from an identification band, both before and after its replacement (i.e. radiology examination). If the treatment plan requires different instances of care, such as chemotherapies, and when a record should be captured for each instance, the SRIN linked to the GSRN may be used.

2.6 Special applications

2.6.1 Coupons

A coupon is a digital or paper based voucher that can be redeemed at the point-of-sale for a cash value or free item. Coupon identification is organised at the local level. Determining the data structure of a coupon is, therefore, the responsibility of the GS1 Member Organisations for their area of jurisdiction.

The purpose of coupon numbering and symbol marking is to automate and speed up coupon handling procedures at the point-of-sale. Moreover, coupon issuers and retailers may be able to reduce the costs involved in sorting coupons, administering manufacturers' payments, and producing reports on redemption.

All GS1 system coupon standards presented here allow for coupon validation (e.g., to check whether the item(s) covered by the coupon is within the customer's order).

If either validation or value look up is performed, manufacturers must advise their distributors and retailers of the impending issue of a coupon so that retailers' files can be updated to process the information at the point-of-sale.

A GS1 system coupon number is used for numbering promotional coupons for manufacturers and retailers as well as tokens with monetary value, such as gift tokens, book tokens, food stamps, luncheon vouchers, and social security tokens.

The structure of GS1 system coupon numbers ensures uniqueness against all other GS1 system numbers only when used within the monetary area of the appropriate GS1 Member Organisation(s).

2.6.2 Coupons identified using the Global Coupon Number

2.6.2.1 Paper coupons

Application description

A paper coupon is a physical representation that is distributed and presented in hard-copy form, and can be exchanged for a financial discount or for loyalty points when making a purchase.

Paper coupons may be identified by a Global Coupon Number (GCN) assigned by the coupon issuer. The GCN comprises a GS1 Company Prefix followed by a coupon reference. It may be supplemented by an optional serial number.

Before implementing the Global Coupon Number to identify paper coupons, it is advised that the issuer of the coupons confirm the acceptance of the Global Coupon Number with their trading partners. Several options exist for coupons with restricted geographic distribution that may be preferred method of identifying coupons, see section [2.6.3](#).

GS1 key

Definition

The Global Coupon Number is the GS1 identification key that provides a globally unique identification for a coupon, with an optional serial number.

The GS1 Application Identifier to indicate the Global Coupon Number (GCN) is AI (255) (see section [3.2](#) for a list of all GS1 Application Identifiers).

Rules

All the GCN application rules described in section 4.

Attributes

Required

Not applicable

Optional

To provide additional information to the Global Coupon Number, the following AIs can be used: AI (17) Expiration date, AI (390N) Coupon value – Single monetary area or AI (394n) Percentage discount of a coupon or AI (8111) Loyalty points of a coupon (see section 3).

Data carrier specification

Carrier choices

GS1 DataBar

Symbol placement

Not applicable

Examples

Example 1 Coupon with GCN



Coupon barcode contains AI (255) GCN (serialised) which serves as database access to all relevant coupon data.

Example 2 Coupon with GCN and free gift amount



Coupon barcode contains AI (255) GCN (serialised) and AI (3900) AMOUNT with value "000" which indicates a free gift. In order to process this coupon value correctly as free gift the till software needs to be adjusted accordingly.

Example 3 Coupon with GCN, expiration date and coupon value



Coupon barcode contains AI (255) GCN, AI (17) EXPIRY and AI (3902) AMOUNT (two decimals)

Example 4 Coupon with GCN and loyalty points

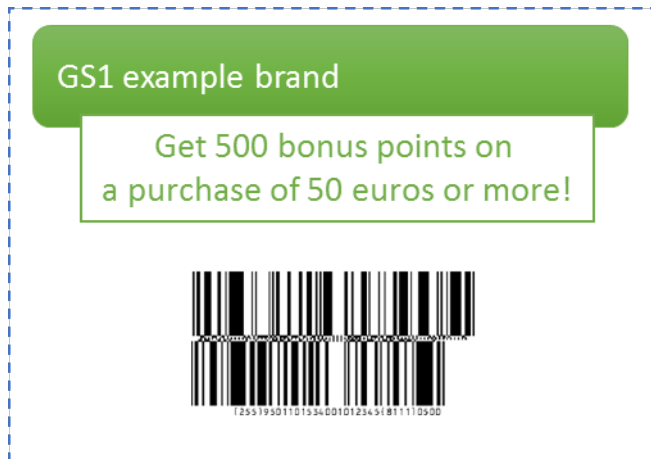

Coupon barcode contains AI (255) GCN (serialised) and AI (8111) POINTS

Example 5 Coupon with GCN and percentage discount



Coupon barcode contains AI (255) GCN and AI (3941) PRCNT OFF (one decimal)

2.6.2.2 Digital coupons

Application description

A digital coupon is an electronic presentation that is distributed and presented without manifesting as “paper” or in other hard-copy form, and can be exchanged for a financial discount or for loyalty points when making a purchase. GS1 global standards enable efficient digital coupon processes for the benefit of:

Brands who can execute offers in the same way in multiple countries and with multiple retailers. Brands can have more relevant/targeted marketing and campaign opportunities tied to specific factors (ex. Location, consumer, products, interest, and interaction with media).

Mobile industry and solution providers who will have a baseline and one standard to implement rather than multiple.

Retailers who can accept offers from coupon issuers in one rather than multiple ways and can understand how to configure (and possibly upgrade) the POS system. Retailers can also accept digital coupons acquired from multiple distributions channels, process them in a uniform and standard way, and integrate where appropriate with their loyalty system.

Consumers who will have a consistent and a satisfying experience when they manage their coupon offers (digital coupons are searchable, sort-able, allowing customers to browse by merchant, category, offer date, and other criteria).

The following diagram illustrates the digital coupon management process. The process is specified in detail in the *Digital Coupon Management Standard Specification Document*.

Figure 2.6.2.2-1. Digital coupon management process

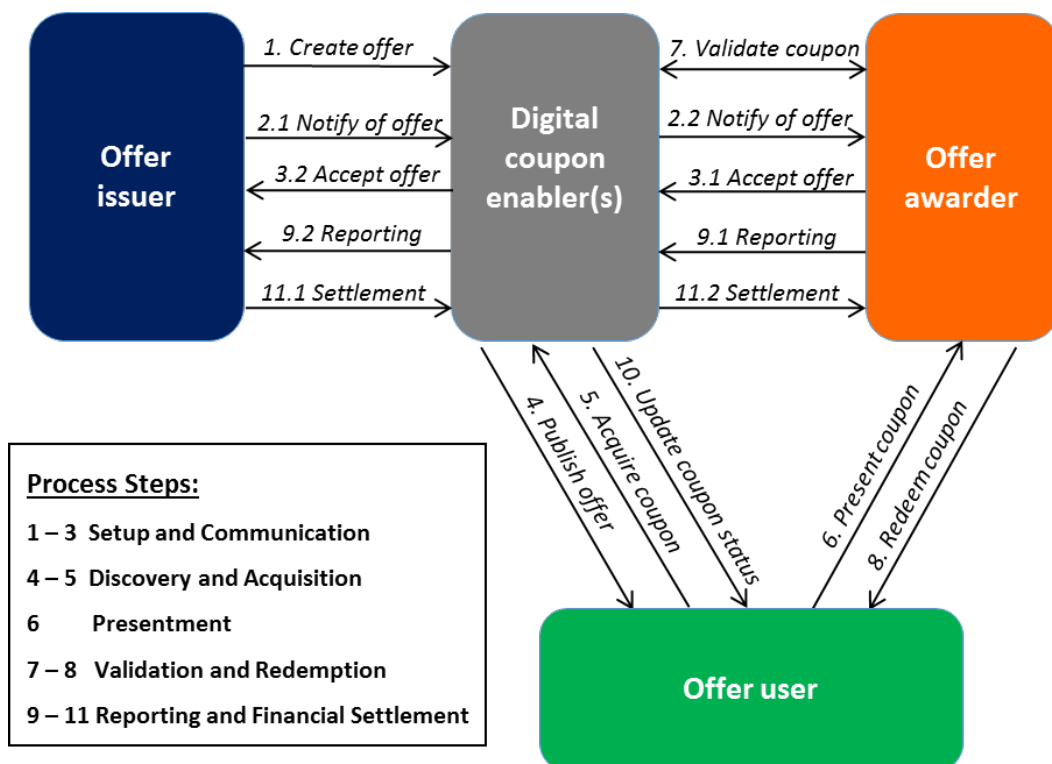

2.6.2.2.1 Relation with existing coupon specifications

The digital coupons specification will co-exist in the foreseeable future with coupon specifications described in section 2.6.3 that are restricted to national or common currency regional applications specified by the respective GS1 Member Organisations.

2.6.2.2.2 Identification requirements for digital coupons

The digital coupon management process specifies the following identification requirements:

- Parties, e.g. offer issuer, digital coupon enabler, retailer, SHALL be identified with a GLN.
- Digital coupons are always related to offers and promotions on products or services. Products as well as services shall be identified with a GTIN.
- Digital coupons may be managed in conjunction with loyalty cards. If appropriate, consumer loyalty cards accounts may be identified with a GSRN.

Digital coupons SHALL be identified by a Global Coupon Number assigned by the coupon issuer. The GCN comprises a GS1 Company Prefix followed by a coupon reference. It may be supplemented by an optional serial number.

GS1 key

Definition

The Global Coupon Number (GCN) is the GS1 identification key that provides a globally unique identification for a coupon, with an optional serial number.

The GS1 Application Identifier to indicate the Global Coupon Number (GCN) is AI (255) (see section [3.2](#) for a list of all GS1 Application Identifiers).

Rules

All the GCN Application Rules described in section 4.

Attributes

Required

Not applicable

Optional

Not applicable

Data carrier specification

Carrier choices

Data carrier specifications for the GCN were out of scope and therefore not addressed when this standard was developed. Local implementations may choose to use the GS1 DataBar to carry the coupon identifier, as it is the only carrier that is capable of holding the identifier structure that is approved for POS use within the GS1 system.

Symbol placement

Not applicable

2.6.3 Coupons with restricted geographic distribution

2.6.3.1 General rule

GS1 system coupon identification specifications are flexible and have been designed to cater to current and future requirements.

Due to the nature of coupon numbering, a range of national solutions is offered, each of which is defined by the respective GS1 Member Organisation. National coupon solutions are not unique worldwide and must be operated in the restricted area defined by the GS1 Member Organisation.

In the interest of consistency and to avoid misinterpretation by equipment vendors, when defining national specifications, GS1 Member Organisations SHOULD include appropriate mention of all GS1 system coupon data structures.

Coupon reference numbers must not be reused for a period of three years.

2.6.3.2 Recommendation on allocating coupon reference numbers

The exact method used to allocate GS1 system coupon reference numbers is left to the discretion of the issuing organisation. However, the GS1 US Coupon Code must be unique for each individual promotion. For ease of administration, coupon reference numbers SHOULD be allocated sequentially.

2.6.3.3 Coupon identification for restricted geographic distribution (GS1 Prefix 99)

Application description

A coupon is a voucher with a cash value that is deducted at the point-of-sale. It is sometimes associated with a specific trade item. Coupon identification is organised on a national level and is therefore not unique worldwide. The specification of the coupon data structure in the element string is the responsibility of each GS1 Member Organisation. The internationally agreed standard for GS1 system coupon numbers is shown in the figure below.

Figure 2.6.3.3-1. Format of the element string

GS1 Prefix	Coupon data (structure determined by GS1 Member Organisation)	Check digit
9 9	N ₃ N ₄ N ₅ N ₆ N ₇ N ₈ N ₉ N ₁₀ N ₁₁ N ₁₂	N ₁₃

The GS1 Prefix 99 denotes the element string for GS1 coupon identification.

The structure of the coupon data field is determined according to the needs of a particular country. Mandatory components are the coupon issuer number and the coupon reference number. Other useful data are the redemption value in real or encoded format and codes for the decimal point or tax rates.

The check digit is explained in section 7.9. Its verification, carried out automatically by the barcode reader, ensures that the data corresponds with the verification rules.

The data transmitted from the barcode reader means that the data of a coupon has been captured. Processing of coupons at a point-of-sale usually consists of validity checks and deduction of its value.

Within this agreed standard for GS1 system coupon numbers, each GS1 Member Organisation is free to develop a national coupon solution. Four recommended structures provide a degree of equipment standardisation. These recommended structures are shown in the figure below.

Figure 2.6.3.3-2. Recommended coupon data structures

GS1 Prefix	Recommended coupon data structures (exact structure determined by GS1 Member Organisation)	Check digit
9 9	Y Y Y Y R R R V V V	C
9 9	Y Y Y R R R V V V V	C
9 9	Y Y Y Y Y R R R T T	C
9 9	Y Y Y Y Y R R R R R	C

Where:

- Y** = Coupon issuer number (issued by the GS1 Member Organisation).
- R** = Coupon reference number (allocated by a coupon issuer).
- V** = Redemption value.
- T** = Value code (standardised by the GS1 Member Organisation).
- C** = Check digit calculated according to the standard algorithm.

The GS1 Member Organisations or retailers may require that the third digit of the coupon numbers (990 to 999) be programmable in order to cope with specific demands such as:

- Taxable or non-taxable coupons.
- Different currencies.

- Indication of the decimal position.

GS1 key

Definition

Not applicable

Rules

Not applicable

Attributes

Required

Not applicable

Optional

Not applicable

Rules

Not applicable

Data carrier specification

Carrier choices

A coupon with the GS1 Prefix 99 is carried by the EAN-13 barcode.

The system recognises this element string by the symbology identifier **JE0** and the GS1 Prefix.

Symbol X-dimension, minimum symbol height, and minimum symbol quality

See section [5.5.2.7.1](#), GS1 system symbol specification table 1.

Symbol placement

Not applicable

Unique application processing requirements

For a description of processing requirements, see section 7.

2.6.3.4 GS1 common currency coupon identification (GS1 Prefixes 981 to 983)

A coupon is a voucher with a cash value that is deducted at the point-of-sale. It is sometimes associated with a specific trade item. Coupon identification is normally organised on a national level using the GS1 Prefix 99. However, for a common currency area, coupon identification is organised between participating countries. Determining the coupon data structure in the element string is the responsibility of all the GS1 Member Organisations in the common currency area. The GS1 Prefixes 981 to 983 have been released for use with coupons expressing a value in a common currency.

The structure of the coupon data positions is determined according to the needs of a particular set of countries. Mandatory components are the coupon issuer number and the coupon reference number. Further useful data is the redemption value in real or encoded format and numbers for the decimal point or tax rates.

The check digit is explained in section [7.9](#). Its verification, carried out automatically by the barcode reader, ensures that the data corresponds with the verification rules. The internationally agreed standard for GS1 common currency coupon codes is shown in the figure below.

Figure 2.6.3.4-1. Format of the element string

GS1 Prefix	Coupon data (structure determined by GS1 MOs in common currency area)	Check digit
9 8 1		
-	N ₄ N ₅ N ₆ N ₇ N ₈ N ₉ N ₁₀ N ₁₁ N ₁₂	N ₁₃
9 8 3		

Within this structure, GS1 Member Organisations in a common currency area SHOULD develop a common coupon solution that is valid throughout the common currency area.

2.6.3.5 Use of GS1 common currency coupon code for the euro

Application description

At present the only application of GS1 Prefixes 981, 982 and 983 is for the euro. Within the euro area, coupon issuer numbers are administered by:

GS1 BELGIUM • LUXEMBOURG

Rue Royale 76 b1

1000 Brussels

Belgium

Tel: + 32.2.229.18.80

Fax: + 32.2.217.43.47

Contact: info@gs1belu.org

See the figure below for the coupon data structure in the euro area.

Figure 2.6.3.5-1. Format of the element string

GS1 Prefix	Coupon data			Check digit
9 8 1	Y ₁ Y ₂ Y ₃ Y ₄	R ₁ R ₂	E E , E	C
9 8 2	Y ₁ Y ₂ Y ₃ Y ₄	R ₁ R ₂	E , E E	C
9 8 3	Y ₁ Y ₂ Y ₃ Y ₄	R ₁ R ₂	E , E E	C

- Where:
- Y = Coupon issuer number (issued by a GS1 Member Organisation).
 - R = Coupon reference number (allocated by a coupon issuer).
 - E = Redemption value (expressed in euro); value 000 indicates free gift.
 - C = Check digit calculated according to the standard algorithm.



Note: The only difference between the two structures is the position of the implied decimal point.

GS1 key

Definition

Not applicable

Rules

Not applicable

Attributes

Required

Not applicable

Optional

Not applicable

Rules

Not applicable

Data carrier specification

Carrier choices

A coupon with the GS1 Prefix 981, 982 or 983 is carried by the EAN-13 barcode.

The system recognises this element string by the symbology identifier **JE0** and the GS1 Prefix. The data transmitted from the barcode reader means that the data of a common currency coupon has been captured. Processing of coupons at a point-of-sale usually consists of validity checks and deduction of its value.

Symbol X-dimension, minimum symbol height, and minimum symbol quality

See section [5.5.2.7.1](#), GS1 system symbol specification table 1.

Symbol placement

Not applicable

Unique application processing requirements

For a description of processing requirements, see section 7.

2.6.3.6 Coupon code identification for use in North America (AI 8110)

Application description

This GS1 Application Identifier has replaced the GS1 US Prefix 5 system in 2011. The new system has been rolled out for paper coupons.

See GS1 US for the *North American Coupon Application Guideline using GS1 DataBar Expanded Symbols* for detailed information on GS1 US coupon code data content.

A stimulus for change is the fact that GS1 US has begun issuing variable-length GS1 Company Prefixes and retailers are expected to accept imported products identified with GS1 Company Prefixes. Both changes will lead to an increasing number of coupon mis-redemptions if the full Company Prefix is not processed. This will impact retailers, manufacturers, and coupon processing agents.

The new coupon format has a large number of fields (many of them optional) for specifying the more complex coupon offers in use today. Data encoded in the coupon barcode is used to identify the source (typically a manufacturer) producing the coupon, the conditions for fulfilling the offer and the specific save value offered to the consumer.

2.6.3.7 Paperless Coupon code identification for use in North America (AI 8112)

Application description

See GS1 US for the *North American Coupon Application Guideline using GS1 DataBar Expanded Symbols* for detailed information on GS1 US coupon code data content.

When a transaction occurs at the point-of-sale the record of the transaction is the cash in the drawer, this is reconciled against the transaction log in the retailers accounting system. When a coupon is presented and redeemed, the coupon is treated just like cash and it also is used to reconcile the cashiers till. When a paperless coupon is accepted and redeemed at point of sale there is no record of the transaction as there is for paper coupons and cash transactions. If a paperless coupon is presented using the same GS1 Application Identifier as is used for paper coupons the reconciliation process and the audit requires the paper backup. If a paperless coupon is presented using its own AI, the requirement for a paper backup is not required, since the transaction log will note that the coupon is paperless.

The paperless coupon format has a large number of fields (many of them optional) for specifying the more complex coupon offers in use today. Data transmitted is used to identify the source (typically a manufacturer) producing the paperless coupon, the conditions for fulfilling the offer and the specific save value offered to the consumer.

2.6.4 Refund receipts

Application description

Refund receipts are vouchers produced to automate payment for returned empty containers. Refund receipts automate and expedite the handling of empty containers (e.g., bottles, crates) that have a refund value in a retail store.

When customers return empty containers (that have a refund value), the containers have to be checked and valued. This process can be done manually or by automated equipment capable of handling empty containers. When the returned containers have been valued, a refund receipt is printed and given to the customer. The customer presents the refund receipt at the store checkout, and the corresponding amount is refunded in cash or deducted from the customer's bill.

An EAN-13 barcode can be printed on the refund receipt to encode the required data including a security number and the monetary value.

The structure of refund receipts ensures uniqueness against all other GS1 system ID numbers only when used within the restricted environment defined by the appropriate GS1 Member Organisation.

The GS1 Prefix 980 has been released for use with refund receipt data. The internationally agreed standard for GS1 system refund receipt data is shown in the figure below.

Figure 2.6.4-1. Format of the element string

GS1 Prefix	Refund receipt data (structure determined by GS1 Member Organisation)	Check digit
9 8 0	N ₄ N ₅ N ₆ N ₇ N ₈ N ₉ N ₁₀ N ₁₁ N ₁₂	N ₁₃

Within this structure, each GS1 Member Organisation develops its own national refund receipt solution. The recommended structure shown in the figure below provides some degree of equipment standardisation.

Figure 2.6.4-2. Format of the element string

GS1 Prefix	Recommended structure	Check digit
9 8 0	S S S S S V V V V	C
<p>S = Security number. This number is used to provide some security in the handling of the refund receipt. For example, it consists of a sequential number, which is incremented by 1, for each ticket generated. In this case, the point-of-sale system will be able to recognise a refund receipt that had already been refunded. The security number can also include a two-digit machine number and a three-digit sequential number, in the case where several machines are available to the customers at the same location.</p> <p>V = Monetary value of the refund. The scale factor (decimal places) will depend on the currency used.</p> <p>C = Check digit. Calculated according to the standard algorithm</p>		

GS1 key

Definition

Not applicable

Rules

Refund receipt specifications are flexible and have been designed to cater for current and future requirements.

Due to the nature of refund receipt identification, several national solutions are offered, each of which is defined by the respective GS1 Member Organisation. National refund receipt solutions are not unique worldwide and must be operated in the restricted circulation defined by the GS1 Member Organisation.

Data carrier specification

Carrier choices

EAN-13 barcodes are used with refund receipts.

Symbol s-dimension, minimum symbol height, and minimum symbol quality

See section [5.5.2.7.1](#), GS1 system symbol specification table 1.

Symbol placement

Not applicable

Unique application processing requirements

For a description of processing requirements, see section 7.

2.6.5 Electronic serial identifier for cellular mobile telephones (CMTI): AI (8002)**Application description**

The purpose of an electronic serial identifier, AI (8002), for cellular mobile telephones (CMTI) is to uniquely identify a cellular phone within a given jurisdiction.

The information from the barcode can be used to automate and speed up the capture of CMTIs. CMTIs are usually assigned by a national or pluri-national authority. Issuing authorities must ensure that the electronic serial identifier is unique for each cellular phone. However, because electronic serial identifiers are assigned by different issuing authorities, they are not unique worldwide. An electronic serial identifier, AI (8002), is assigned by the appropriate national or pluri-national body and can be carried by a barcode placed directly on the cellular phone. The electronic serial identifier, AI (8002), is unique for each cellular telephone within the jurisdiction of the issuing body.

GS1 key**Definition**

Not applicable

Rules

Not applicable

Attributes**Required**

See section [3.2](#), Cellular mobile telephone identifier: AI (8002).

Optional

Not applicable

Rules

Not applicable

Data carrier specification**Carrier choices**

The electronic serial identifier for cellular mobile telephones (CMTI), AI (8002), is carried by the GS1-128 barcode.

Symbol X-dimension, minimum symbol height, and minimum symbol quality

See section [5.5.2.7.4](#), GS1 system symbol specification table 4.

Symbol placement

Not applicable

Unique application processing requirements

Not applicable

2.6.6 Payment slips

Application description

A payment slip is that part of a paper invoice used to facilitate payment. Payment slips cover a wide range of payment demands, such as telephone bills, electricity bills, and insurance renewals. The payment slip is normally issued by a service provider (the invoicing party) to a final customer (the invoicee) and represents a payment demand. Normally the payment slip would outline in non-HRI text:

- Details of the customer.
- Details of the service provider.
- A detailed invoice for the service(s) provided.
- A reference number.
- The amount payable.
- The payment conditions (e.g., pay before date, where to pay).

GS1 key

Definition

Not applicable

Rules

Not applicable

Attributes

Required

- **Global Location Number of the invoicing party** – The GS1 Application Identifier (AI) to indicate the Global Location Number (GLN) of the invoicing party is AI (415) (see section 3). The GLN of the invoicing party identifies the issuer of the payment slip. It is used as a key to access database information about the invoicing party (normally held by the payment receiving agency). The same GLN is used for all payment slips issued by the invoicing party under identical payment conditions. The GLN of the invoicing party is used by the payment receiving agency to reference the characteristics of the contract with the invoicing party, such as:
 - Whether the payment can be accepted.
 - Contact details of the invoicing party.
 - Action to take if the due date has expired.
 - Transfer arrangement of funds to the invoicing party's bank.

A different GLN SHALL be used whenever the payment conditions are different. For more information, see section 4.

- **International Bank Account Number (IBAN): AI (8007)** – The GS1 Application Identifier to indicate the International Bank Account Number (IBAN) is AI (8007). See section [3.2](#) for a list of all GS1 Application Identifiers.

The bank account identifier of the invoicing party is defined in *ISO 13616*. It is used to identify where to send the payment and, in the receiving country, which bank holds the account for international bank payment.

- **Payment slip reference number: AI (8020)** – The GS1 Application Identifier to indicate a payment slip reference number is AI (8020). See section [3.2](#) for a list of all GS1 Application Identifiers.

By their nature, payment slips need to be individually tailored for the invoicee and, therefore, require a unique reference number, the payment slip reference number, AI (8020). Reminder notices SHOULD use the same number as the original notice. The payment slip reference

number, AI (8020), is issued by the invoicing party and is a unique number in the system. Payment slip reference numbers, AI (8020), SHOULD be sequentially allocated.

The payment slip reference number, AI (8020), uniquely identifies the payment slip when used in conjunction with the Global Location Number (GLN) of the invoicing party. It is used to communicate details of payment among all the partners involved: invoicing party, invoicee, payment receiving agency, and banks. It is also used to access locally held information.

- **Amount payable** – There are two GS1 Application Identifiers to indicate the amount payable:
 - AI (390n) = amount payable for a single monetary area. See section [3.2](#) for a list of all GS1 Application Identifiers.
 - AI (391n) = amount payable with ISO three-digit currency code. See section [3.2](#) for a list of all GS1 Application Identifiers.

(n = indicates the implied decimal point position)

If the amount payable is expressed in a barcode, AI (391n) should be used, as this ensures the currency of the payment can be automatically processed and verified by the system. However, if the currency is unambiguously implied by the system, AI (390n) may be used. To avoid ambiguity, only one AI encoding the amount payable SHALL be used, and the currency must be clearly indicated in human readable form.

Scanning systems should have the facility to override the amount payable. This functionality is required should the invoicee wish to make the minimum required payment, which could be less than the total amount due. The amount due is attribute information and, when used, must be processed with the Global Location Number (GLN) of the invoicing party.

- **Due date for amount on payment slip** – The GS1 Application Identifier to indicate the due date is AI (12). See section [3.2](#) for a list of all GS1 Application Identifiers.

The due date indicates the date by which the invoice should be paid (by the invoicee). It is attribute information and, when used, must be processed with the Global Location Number (GLN) of the invoicing party.



Note: The due date must be represented in the YYMMDD format in the barcode; however, the human readable interpretation can be presented in whatever form is appropriate.

Optional

Not applicable

Rules

See section [4.13.2](#), Mandatory association of element strings.

Data carrier specification

Carrier choices

The GS1-128 barcode is used with payment slips. They in no way replace the need for the human readable interpretation.

Symbol X-dimension, minimum symbol height, and minimum symbol quality

See section [5.5.2.7.4](#), GS1 system symbol specification table 4.

Symbol placement

No standard placement. The figure below is an example.

Figure 2.6.6-1. Example of numbering and symbol marking for payment slips

<p>ABC-Electric Company</p> <p>Mr A.N. Customer 45 Sunrise Drive Cape Town, TX 765444</p> <p>Electricity consumption period: 1 January 2001 to 31 March 2001</p> <p>Amount Payable 12.50 South African Rand</p> <p>DUE DATE 25 April 2001 PAY TO: 5412345678908 REF NO.: ABC123</p>		 <p>(415) 5412345678908 (3911) 710125</p>
	 <p>(12) 010425 (8020) ABC 123</p>	

Notes to the example in figure 2.6.6-1:

- **(415) 5412345678908** – AI (415) indicates the Global Location Number (GLN) of the invoicing party. The GLN is a fixed length 13-digit number terminated by a standard check digit. The rules for allocating GLNs ensure that this number is unique worldwide. GLNs are used by the payment receiving agent to distinguish between payment slips that can and cannot be accepted.
- **(12) 010425** – AI (12) indicates the due date by which the payment should be made. The due date is always encoded YYMMDD; however, other formats may be used for the human readable interpretation equivalent. The use of the due date is optional, but if used, the payment receiving agent and the invoicing party SHOULD agree about what action will be taken if the due date has expired.
- **(3911) 710125** – AI (3911) indicates the amount payable with ISO currency number. From *ISO 4217*, “710” indicates South African Rand. It is strongly recommended to use the ISO currency number when encoding this optional data element. The fourth digit of this AI is the decimal point indicator. For example, the digit 1 in this position would indicate one digit after the decimal point; a 2 would indicate two digits after the decimal point.
- **(8020) ABC123** – AI (8020) indicates the payment slip reference number. The payment slip reference number, AI (8020), is a mandatory data element for this application. It is processed with the GLN of the invoicing party and provides a unique reference for all communications between the payment agent and the invoicing party.

Unique application processing requirements

Not applicable

2.6.7 Customer specific articles

2.6.7.1 Introduction

The GS1 system guidelines for trade items (see section [2.1](#)) state that each item of trade is assigned a non-significant number that uniquely identifies the item in an unrestricted environment. The same number is used to identify a series of identical items, with every variant being allocated a separate unique identification number whenever the variation is apparent and significant between partners in the supply chain or to the final user.

This system enables the use of Automatic Data Capture (ADC) and Electronic Data Interchange (EDI) in an open environment, globally. However, in a number of business sectors, because of the

vast number of possible manifestations of certain made-to-order articles, pre-allocation of Global Trade Item Numbers (GTINs) at the lowest level is not feasible.

For organisations that trade in such made-to-order products, GS1 in association with trade representatives has developed the following guidelines. They have been designed to improve supply chain efficiency by enabling ADC and, in particular, efficient ordering via EDI.

These guidelines are fully compatible with, and should be treated as a special case of, the GS1 system recommendations for the numbering and symbol marking of trade items.

2.6.7.2 Application overview

2.6.7.2.1 Definition

A customer specific article (CSA) is broadly defined as any item where the supplier defines all possible manifestations of the article from which the customer may choose, and pre-allocation of article numbers at the lowest level is not feasible. CSAs are never made for stock, and hence are always made to order. However, made-to-order articles are not necessarily customer specific, but could be standard.

A typical example of a CSA is a chair that is available in 300 different types of upholstery for the seat, back, and armrest. This list of available upholstery could also be used for other types of furniture the supplier offers. There are 27,000,000 ordering possibilities for this chair (300 x 300 x 300). Typically the supplier's catalogue lists a generic style of chair as well as the 300 different upholstery options. The customer chooses the style of chair and selects upholstery for the seat, back, and armrest.

On receipt of order, the supplier produces the customer specific chair and makes it available to the customer. Because the supplier defines the customer's options, and because the customer must specify his or her choices based on those options, the order contains all the information the supplier requires to manufacture the chair. This example highlights four separate process steps:

- The supplier makes available all the possible manifestations of an article.
- The customer specifies the actual article required using the supplier catalogue.
- The supplier manufactures the article in accordance with the customer's specifications.
- The CSA is delivered.
- The GS1 system has formalised this process, enabling efficient Automatic Data Capture (ADC) and Electronic Data Interchange (EDI) throughout the supply chain. The CSA data model is based on the assumption that the supplier defines the possible components (either in a paper or electronic catalogue) and the customer specifies the actual article required.

The processes for identifying and ordering the article are dealt with separately. Although these processes are closely related, each requires separate consideration in an open system.

2.6.7.2.2 Customer specific articles data flow

The data flow model is organised on a series of assumptions designed to ensure that the model is independent of the type of article and the sector: It is a generic model. Because many different procedures may be applied by various manufacturers, the generic model is meant to be a general guide. By using this model, companies can communicate in a standard way and (re)organise the automated handling of customer specific article (CSA) specification according to this guideline.

The model assumes that the supplier informs the customer of all available ordering options and specifications. This is achieved by means of an electronic catalogue (see the figure below). From this catalogue the customer can determine which article(s) to order. In the order message the base article number and the chosen specifications are communicated.

Figure 2.6.7.2.2-1. Customer Specific Articles - data flow

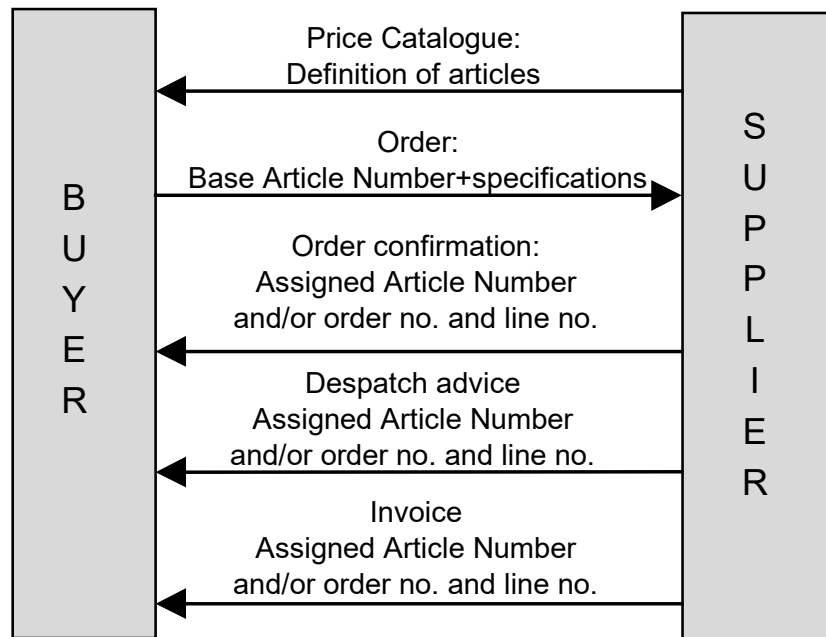

In the order confirmation, the supplier may confirm that the article ordered can be manufactured (that is, that the buyer has made a correct combination of specifications). This should be the case assuming the customer has up-to-date database information. The order confirmation may also be used to notify the customer of the assigned article number. The assigned article number may be used in all subsequent communications. For example, the despatch advice and invoice messages use the assigned article number and, if required, the order number plus the order line number to establish an unambiguous link with the CSA.

The article produced may not be numbered with a string of numbers representing the base article number plus the applicable specifications (see section [2.6.7.4.5](#)).

2.6.7.3 Allocating system numbers for customer specific articles

2.6.7.3.1 General rule

Each different product must be identified by a unique number. This implies that each variant of a product is assigned a different number. For example, each different size or colour of a garment has its own individual identification number. Article numbers SHOULD be sequentially allocated for this purpose.

2.6.7.3.2 Ordering of customer specific articles

The ordering process of customer specific articles (CSAs), the customer specification process, is based on a supplier's catalogue definitions. Internal identification systems are often manual and become increasingly complex and prone to error as the number of trading partners increases. In addition, the use of internal codes can be cumbersome, inflexible, and prone to duplication among different suppliers. These recommendations, which are based on the open systems principle, seek to avoid internally-based systems. Catalogue products using GS1 system identification numbers are guaranteed to be uniquely identifiable worldwide.

A customer specific articles EANCOM user profile for the price catalogue (PRICAT), orders (ORDERS), and the response to order (ORDRSP) messages have been published that use the numbering system outlined in the following subsections.

2.6.7.4 Base article number

A supplier assigned base article number is given to each generic product type for ordering purposes. A GTIN-13 is used for this functionality. The GTIN-13 is defined by the supplier and must be unique with respect to all other GS1 system identification numbers. Because it does not identify an item, the base article number will never be carried by a barcode on an article. It is solely used for ordering purposes.

The base article number indicates to the customer that a number of supplier defined questions have to be answered by the customer. These specifications (questions and associated answers), which are relevant to a base article number, are communicated via an electronic catalogue. The specifications available for each different article are defined by the supplier.

2.6.7.4.1 Specifications

Specifications are linked to the different base article numbers for the purposes of ordering. The same specifications may be used with different base article numbers. Specifications fall into one of the categories described in the following subsections.

2.6.7.4.2 Option

An option is a specification with a discrete value that is predefined by the supplier and associated with a base article number.

Each option may be identified with a GTIN-13. The GTIN-13 is defined by the supplier and must be unique with respect to all other GS1 system identification numbers. An ID number of an option will never be carried by a barcode on an article. It solely is used for communication purposes.

Options, such as red leather seat covers may be valid for different base articles.

2.6.7.4.3 Parameter

A parameter is a specification within a range of values (e.g., dimensions) ranging from a minimum to a maximum and including a step size.

Each parameter may be identified with a GTIN-13. The GTIN-13 is defined by the supplier and must be unique with respect to all other GS1 system identification numbers. The parameter identification will never be carried by a barcode on an article. It is solely used for ordering purposes. Parameters SHOULD be communicated using the standard EANCOM syntax and SHOULD be related to a base article number.

2.6.7.4.4 Part

A part is a physical article that may also be ordered separately. Parts are identified within Global Trade Item Numbers (GTINs). The GTIN-13 for the part may be used in association with a base article number to create a composite, an article made up of one or more individual parts. A part may be associated with a number of different base articles.

2.6.7.4.5 External references

An external reference is often required for a customer-designed or custom-made item. External references are specified through a separate, non-EDI communication channel, such as a fax or CAD/CAM drawing. A secondary source can be used to communicate a set of customer-defined specifications (not predefined by the supplier).

2.6.7.4.6 Data carrier

GS1 system identification numbers used to identify customer specific articles (CSAs) for ordering purposes may never be carried by a barcode on the physical article. However, suppliers may wish to utilise barcode scanning as part of the order process. This may be achieved by representing base articles and identification numbers in machine readable form in a paper catalogue. GS1-128 barcodes, utilising an GS1 Application Identifier for internal applications, SHOULD be used for this purpose.

2.6.7.5 Identification of the physical article actually produced

Application description

In environments with automated systems the physical article needs to be identified and the identification of the produced article is required in machine readable form (as a barcode). The identification of the physical article must be communicated from the supplier to the customer. Both supplier and customer should be able to use the same identification number and each need to keep a record of this number.

For open systems, the most appropriate identification number is the GTIN-13. Identifying a physical article with a GTIN-13 and a barcode allows customer specific articles (CSAs) to be integrated within a system that manages all other items identified using the GS1 system. During order confirmation, the supplier assigns GTIN-13 to the product. It is not necessary to pre-assign numbers to all possible articles, only to those that are actually produced.

Each different product must be identified by a unique number. This implies that each variant of a product is assigned a different number. For example, each different size or colour of a garment has its own individual identification number. Article numbers SHOULD be sequentially allocated for this purpose.

GS1 key

Definition

The Global Trade Item Number (GTIN) is the GS1 identification key used to identify trade items. The key is comprised of a GS1 or U.P.C. Company Prefix followed by an item reference and a check digit.

Rules

All the GTIN rules described in section 4.

Attributes

Required

Not applicable

Optional

Not applicable

Data carrier specification

Carrier choices

The barcode requirements for customer specific articles (CSAs) are the same as those for trade items. The data carrier used to carry the GS1 system identification number of a physical article SHALL be one of the following:

- EAN-13, or UPC-A barcode.
- ITF-14 barcode.
- GS1-128 barcode (attribute information always uses GS1-128 barcodes).

With CSAs, the choice of data carrier is left to the discretion of the organisation responsible for issuing the GS1 system identification number. Trade items that will be scanned at a point-of-sale always SHOULD be marked using the EAN/UPC symbology.

Symbol X-dimension, minimum symbol height, and minimum symbol quality

See section [5.5.2.7.1](#), GS1 system symbol specification table 1.

Symbol placement

Not applicable

Unique application processing requirements

For a description of processing requirements, see section 7.

2.6.8 Custom trade item

2.6.8.1 Allocating system numbers for custom trade items

2.6.8.1.1 General rule

Customer specific items, as described in the previous section, (section [2.6.7](#)) are configured from a wide variety of known parameters. Things like colour, size, model, and various materials are listed and uniquely identified. A customer specific item is created when a selection is made from each category, sufficient to create the item. Customer specific items may be intended for the end consumer (e.g. furniture) and can be marked with a GTIN and data carrier appropriate for point-of-sale (POS).

Custom made-to-order trade items are different from customer specific items in that they are one-of-a-kind, made-to-order items that are strictly sold from business to business. Their use is approved for the manufacturing and maintenance, repair & overhaul (MRO) environment. Examples include custom abrasive belts, special adhesives, and made-to-order cutting tools needed for a specific machine and cutting application. Their specifications may be called out in a series of blue prints or other technical documents.

Each different product must be identified by a unique number. If a trade item is a stock trade item, it is assigned the appropriate fixed measure GTIN. If any trade item, custom or not, will be scanned at POS, then it must be assigned a GTIN-12, GTIN-8, or GTIN-13 and represented in a barcode symbology approved for POS. At the discretion of the supplier, it is always acceptable to use a GTIN-12, GTIN-8 or GTIN-13 to identify a trade item, whether custom or not. In other words, a supplier or manufacturer is not required to use the method described below to identify a custom item. They may give each and every different trade item a unique GTIN. However, this will deplete their pool of possible GTIN more quickly.

This method of assigning unique product identification uses a base GTIN-14, indicator digit 9 which signifies a GTIN with a variable component (i.e. it is a custom, made-to-order item), followed by a Made-to-Order variation number. The Made-to-Order variation number is a variable length, numeric field up to six digits. This allows each base GTIN-14, indicator digit 9 to be used for 1,000,000 different custom variations. Multiple items, made to the same specifications could have the same combination of the base GTIN-14, indicator digit 9 and Made-to-Order variation number.

2.6.8.1.2 Ordering of custom trade items

A supplier or manufacturer may indicate in their paper or electronic catalogue that certain items can be ordered based on customer specifications. A GTIN-14, indicator digit 9 can be assigned to denote that it is possible to order a customized version of this trade item. However, in this case, no physical item exists. When the order is accepted for the made-to-order custom item, a Made-to-Order Variation number is assigned to this specific version. Multiples of this same item may be ordered at one time. It is the combination of the GTIN-14, indicator digit 9 and the Made-to-Order variation number that uniquely identifies the custom items.

2.6.8.1.2.1 Custom trade item number

A GTIN-14, indicator digit 9 indicates a variable measure trade item. Additional information is needed to complete the identification of the trade item. A custom trade item number is the combination of a GTIN-14, indicator digit 9, and the Made-to-Order variation number. This combination is used in electronic business transactions and in barcode representation. When many items with the exact same specifications are manufactured at one time, they will each carry the same combination of GTIN-14, indicator digit 9 and Made-to-Order variation number.

2.6.8.1.2.2 Base GTIN-14

To indicate that a trade item is available in a custom format, a base GTIN-14, indicator digit 9, is used. A base GTIN-14, indicator digit 9 may appear in the supplier's paper or electronic product catalogue to indicate the possibility of a custom item. This GTIN does not identify a specific trade item, but a general category of possible custom trade items. The description indicates that this is a custom, made-to-order item. A manufacturer may create one GTIN-14, indicator digit 9 to represent

any and all made-to-order trade items, or they may assign one for each category of custom items (custom abrasive belts, custom abrasive pads, etc.). Further a manufacturer may choose to create a GTIN-14 indicator digit 9 for sub-categories (custom abrasive belts, 1 to 2 Inches Wide; custom abrasive belts, 2 to 3 inches wide, and so on).

2.6.8.1.2.3 Made-to-Order variation number

Once the specifications for a custom trade item are agreed upon between the customer and the manufacturer, the manufacturer will assign a Made-to-Order variation number to that custom item. A Made-to-Order variation number is always used with a GTIN-14, indicator digit 9.

The Made-to-Order variation number is communicated from the manufacturer to the customer during the Request for Quote / Response to Request for Quote process or on a Purchase Order Acknowledgement or by some other mutually agreed upon method. In a barcode representation, GS1 Application Identifier AI (242) is used to denote a Made-to-Order variation number. The Made-to-Order variation number is numeric and variable length up to, and including, six digits.

A Made-to-Order variation number will never appear alone, but must always be associated with the appropriate GTIN-14, indicator digit 9. Further, a Made-to-Order variation number may not be used with GTIN-8, GTIN-12, GTIN-13, and GTIN-14 indicator digit 1 through 8.

The use of a GTIN-14, indicator digit 9 and a Made-to-Order variation number is only approved for the manufacturing and maintenance, repair & overhaul (MRO) environment.

2.6.8.1.2.4 Data carrier

GS1 system identification numbers used to identify custom made-to-order items in the manufacturing, pick, pack, shipping, receiving and inventory management process may be carried by a barcode on the physical article. This may be achieved by representing identification numbers in machine readable form. GS1 barcodes, utilising GS1 Application Identifiers, should be used for this purpose.

2.6.8.2 Identification of the physical article actually produced

Application description

In environments with automated systems the physical article needs to be identified and the identification of the produced article is required in machine readable form (e.g. as a barcode). The identification of the physical article must be communicated from the supplier to the customer. Both supplier and customer should be able to use the same identification number and each need to keep a record of this number.

For open systems, the appropriate identification number for a custom trade item is the base GTIN-14 indicator digit 9, followed by a Made-to-Order variation number. During order confirmation, the supplier assigns the Made-to-Order variation number to this version of the product.

Products made to the same specifications can carry the same combination GTIN-14, indicator digit 9, and Made-to-Order variation number.

GS1 key

Definition

The Global Trade Item Number (GTIN) is the GS1 identification key used to identify trade items. The base GTIN-14, indicator digit 9 in combination with the Made-to-Order variation number comprises the key for a custom trade item. The base GTIN-14 is comprised of indicator digit 9, GS1 Company Prefix followed by an item reference and a check digit. The Made-to-Order Variation number is variable length, numeric, up to and including six digits.

Attributes

Required

Not applicable

Optional

Not applicable

Data carrier specification**Carrier choices**

The combination of a GTIN-14, indicator digit 9, and a Made-to-Order variation number, can be carried by using the appropriate GS1 Application Identifiers in the following symbologies:

- GS1-128
- GS1 DataBar
- GS1 DataMatrix
- GS1 QR Code

AI (01) is used for the GTIN-14, indicator digit 9, plus AI (242) for the Made-to-Order variation number when the item is considered a trade item. The combination of AI (02) plus AI (242) and AI (37) Count of trade items contained in a logistic unit, is used in conjunction with an (00) Serial Shipping Container Code when marking a logistics unit of custom trade items.

Symbol X-dimension, minimum symbol height, and minimum symbol quality

See section [5.5.2.7.4](#), GS1 system symbol specification table 4.

Symbol placement

Not applicable

2.6.9 Global Document Type Identifier for document control

Introduction

The Global Document Type Identifier is the GS1 identification key used to identify documents, electronic messages and digital files for the purposes of document control. Any aspect of referenced modification, version control, specific instance recording would fall into the process of document control, either internal or externally with trade partners, where unique identification is required

The term “document” is applied broadly to cover any paper(s) or digital file(s). The Global Document Type Identifier (GDTI) can be used to identify any type of document including but not limited to:

- commercial documents (e.g. invoice, purchase order)
- documents that infer a right (e.g., proof of ownership)
- documents that infer an obligation (e.g., notification or call for military service)
- identification documents (e.g. driver’s licence, passport); and
- digital files
- electronic messages

Application description

Physical documents and electronic messages used in communications with other parties often include a unique number that can be used as a reference. Also digital files shared with other parties may require a unique identifier to ensure the use of the right type and version. The issuer of the document is normally responsible for the identification of the document.

The GDTI enables issuers to assign globally unique identifiers to documents and, where applicable, to physically mark these on the physical version(s) in barcode or EPC/RFID format.

Examples of documents that can be identified with the GDTI include, but are not limited to:

- Land registration papers

- Tax demands
- Proof of shipment/receipt forms
- Custom's clearance forms
- Insurance policies
- Internal invoices
- National press documents
- Educational papers
- Transporting company documents
- Mail company documents
- Images

GS1 key

Definition

The GS1 Application Identifier to indicate the Global Document Type Identifier (GDTI) is AI (253) (see section [3.2](#) for a list of all GS1 Application Identifiers).

Rules

See section [4.8](#), *GDTI rules*.

Attributes

Required

Not applicable

Optional

Not applicable

Data carrier specification

Carrier choices

The GS1-128, GS1 DataMatrix or GS1 QR Code symbology is used to represent the GDTI in barcoded format.

Symbol X-dimension, minimum symbol height, and minimum symbol quality

See section [5.5.2.7.9](#), GS1 system symbol specification table 9.

Symbol placement

No standard placement. The following are examples of numbering and symbol marking for document control:

Unique application processing requirements

For description of processing requirements, see section 7.

Example 1: Legally required declaration prior to travel

This example shows how GS1-128 barcodes can be used to automate the capture of information for traveller who enters or leaves the country.

Figure 2.6.9-1. Legally required travel declaration



Declaration of Luggage and Money of Travellers





(253)950110153005812345678901

Name: _____

Address: _____

Date of Entrance: _____

Items to Declare:

Amount	Description	Value	Customs Value

I have read the instructions and declare the truth: _____

Date and Signature: _____

Document serial number: 12345678901

Example 2: Insurance policy

This example shows how GS1-128 barcodes can be used to automate the capture of information on insurance policies. This standard solution provides benefit for the insurer, the insured, and any potential beneficiaries as well as facilitates the automation of any monitoring and inspection of the requirement to fulfil the legal norms.

Figure 2.6.9-2. Insurance policy

Policy Number:
67890543210987

**Insurance
Company**

Branch: Bogotá	Date of Policy: March 23, 2014
Name: Name of Insured	
Age: 34	Valid From: March 23, 2014
	Valid To: March 22, 2017
Contract Cover: Life	Value: 10,000
Date and Signature:	



(253)950110153006567890543210987

Example 3: Application form

This example shows how GS1-128 barcodes can be used to automate the capture of information on application forms. Many organisations require their clients to complete an application form.

Figure 2.6.9-3. Membership application form

Membership Application Form 7654321	
Name	
Address	
Postal code	
City	
Country	
Telephone number	
Email address	
Signature	Date and place

(253)95011015300657654321

Example 4: Freight-forwarding authorisation

This example shows how GS1-128 barcodes can be used to automate the capture of information on freight-forwarding forms. Many organisations require documentary evidence that goods have been dispatched prior to making payment.

Figure 2.6.9-4. Freight-forwarding authorisation

Suppliers or Forwarders Principals		 FIATA FCT Forwarders Certificate of Transport ORIGINAL		No. 123456 Country Code
Consigned to order of		 (253)9501101530065123456		
Notify address				
Conveyance	from/via			
Destination				
Marks and numbers	Number and kind of packages	Description of goods	Gross weight	Measurement
				
according to the declaration of the consignor The goods and instructions are accepted and dealt with subject to the General Conditions printed overleaf. Acceptance of this document or the invocation of rights arising therefrom acknowledges the validity of the following conditions, regulations and exceptions also of the trading conditions printed overleaf, except where the latter conflict with conditions 1-6 below. 1. The undersigned are authorized to enter into contracts with carriers and others involved in the execution of the transport subject to the latter's usual terms and conditions. 2. The undersigned do not act as Carriers but as Forwarders. In consequence they are only responsible for the careful selection of third parties, instructed by them, subject to the conditions of Clause 3 hereunder. 3. The undersigned are responsible for delivery of the goods to the holder of this document through the intermediary of a delivery agent of their choice. They are not responsible for acts or omissions of Carriers involved in the execution of the transport or of other third parties. The undersigned Forwarders will, on request, assign their rights and claims against Carriers and other parties. 4. Insurance of the goods will only be effected upon express instructions in writing. 5. Unforeseen and/or unforeseeable circumstances entitle the undersigned to arrange for deviation from the envisaged route and/or method of transport. 6. Unforeseen and/or unforeseeable disbursements and charges are for the account of the goods. Insurance through the intermediary or the undersigned Forwarders <input type="checkbox"/> Not covered <input type="checkbox"/> Covered according to the attached Insurance Policy / Certificate All disputes shall be governed by the law and within the exclusive jurisdiction of the courts at the place of issue. For delivery of the goods please apply to: Freight and charges prepaid to: thence for account of goods, lost or not lost.				
Text authorised by FIATA. COPYRIGHT FIATA / Zurich - Switzerland 5.96		We, the Undersigned Forwarders in accordance with the instructions of our Principals, have taken charge of the abovementioned goods in good external condition at: for despatch and delivery as stated above or order against surrender of this document properly endorsed. In witness thereof the Undersigned Forwarders have signed originals of this FCT document, all of this tenor and date. When one of these has been accomplished, the other(s) will lose their validity. Place and date of issue Stamp and signature		

2.6.10 Internal applications

The GS1 system provides ten GS1 Application Identifiers for internal applications.

Data carrier specification

GS1 data carriers that can be used to represent GS1 Application Identifiers for internal applications are:

- GS1 DataBar Expanded Versions
- GS1-128
- GS1 DataMatrix
- GS1 QR Code
- EPC/RFID

Data carrier specifications (e.g., size, quality, placement) are to be determined internally, however GS1-128 symbols SHALL NOT be used for symbols that require more than 48 data characters and GS1 DataBar Expanded Versions SHALL NOT be used when symbols require more than 74 numeric or 41 alphabetic characters of data.

Though the definition of AIs (91) to (99) in the GS1 Tag Data Standard (TDS) allows for larger fields, to ensure compatibility with the General Specification, AI (91) to (99) character values encoded in the User Memory of an EPC/RFID tag should not exceed 90 characters in length.

2.6.10.1 Information mutually agreed between trading partners: AI (90)

Element string AI (90) may be used to represent any information that has been mutually agreed between two trading partners. The agreement may include the use of FACT DIs (Data Identifiers). If a FACT DI is used, it SHOULD appear immediately after the AI (90), followed by the appropriate data. The use of FACT DIs gives little security to users.

The data carrier containing this element string SHOULD be removed from any item that leaves the jurisdiction of the trading partners. Failure to remove the symbol may cause problems if another trading partner using the same AI for a separate internal application scans the item.

2.6.10.2 Company internal information: AIs (91 to 99)

Element strings AI (91) to (99) may contain any internal information relevant to a company's internal applications.

The data carrier containing these element strings SHOULD be removed from any item that leaves the jurisdiction of the company. Failure to remove the symbol may cause problems if a trading partner using the same AI for a separate internal application scans the item.

2.6.11 Consumer trade item production control

This application standard utilises GTIN and a GTIN attribute which are used by consumer trade item manufacturers to ensure the proper association of packaging components during production of a finished consumer trade item. The attribute is called a Packaging Component Number (PCN). The PCN identifies a packaging component which is used by only one manufacturer and is an attribute of the GTIN of the finished consumer trade item. For example, a bottle of cough syrup has a front and back label. It is critical the declarations on the labels match the product filled in the bottle. By using a different PCN on each label during packaging for a specific trade item identified with a GTIN, the manufacturer can ensure the right labels are used to produce the product (GTIN to PCN associations). PCN may be encoded as a standalone symbol or the PCN and GTIN may be encoded together. Package components shared between two or more manufacturers are not covered by this standard. Manufacturers and their packaging component suppliers will have to manage this situation. The PCN is assigned by the manufacturer (possibly under the direction of the brand owner).

GS1 key

Definition

- GTIN-8 is the 8-digit GS1 identification key composed of a GS1-8 Prefix, item reference, and check digit used to identify trade items.
- GTIN-12 is the 12-digit GS1 identification key composed of a U.P.C. Company Prefix, item reference, and check digit used to identify trade items.
- GTIN-13 is the 13-digit GS1 identification key composed of a GS1 Company Prefix, item reference, and check digit used to identify trade items.
- For regulated healthcare non-retail applications, GTIN-14 is the 14-digit GS1 identification key composed of an indicator digit (1-9), GS1 Company Prefix, item reference, and check digit used to identify trade items.

Rules

GTIN of the finished consumer trade item SHALL NOT be used to identify packaging components (e.g., bottle, bottle cap, front label, back label) for the purpose of trade item production control; however GTIN is specified as the GS1 key for consumer trade item production control as the GTIN determines which packaging components are used in production.

Attributes

Required

The GS1 Application Identifier to indicate the Packaging Component Number is AI (243) (see section [3.2](#) for a list of all GS1 Application Identifiers).

Rules

PCN SHALL NOT replace GTIN for pricing, ordering, or invoicing upstream packaging components from the manufacturer's upstream suppliers. Per section [4.13.2](#), PCN has a mandatory association with one or more finished consumer trade item GTIN(s). The PCN and GTIN may or may not be encoded in the same symbol.

PCN is used only on packaging components used by one manufacturer. There may be more than one PCN associated with one GTIN. One PCN may be associated with multiple GTINs

There SHALL only be one PCN per each packaging component for the lifespan of the packaging component and one packaging component may change while another does not. For example a front and back label would each have a unique PCN and the front label may change while the back label does not.

Over a GTIN's lifespan, there may be more than one PCN per packaging component (e.g., front label).

Optional

Not applicable

Data carrier specification

Carrier choices

Figure 2.6.11-1. Carrier choices

Symbol options by consumer trade item type	Type of consumer trade item		
	General retail POS	Regulated healthcare POS (retail)	Regulated healthcare POC (non-retail)
GTIN and PCN in one symbol	GS1 DataBar	GS1 DataBar or GS1 DataMatrix	GS1 DataBar, GS1 DataMatrix, GS1-128, Composite Component
PCN standalone	GS1 symbol selection/size specifications left to the manufacturer's discretion		
GTIN, PCN, & Extended Packaging URL in one symbol	(*) GS1 DataMatrix or GS1 QR Code	GS1 DataMatrix	GS1 DataMatrix
(*) For general retail consumer trade items where PCN is combined with AI (8200) GS1 DataMatrix or GS1 QR Code may be used according to the specifications in Figure 5.5.2.7.1-2 GS1 system symbol specification table 1 Addendum			

Symbol X-dimensions, minimum symbol height, and minimum symbol quality

To determine the appropriate specifications for printing and quality control, see the GS1 system symbol specification table(s) referred to in each Application Standard.

Symbol placement

When the PCN is encoded together with GTIN, symbol placement rules for consumer trade item apply. If the production line scanning of the PCN prohibits use of this symbol placement, the PCN must be encoded in a separate barcode.

Unique application processing requirements

For a description of processing requirements, see section 7.

2.6.12 Component / part identification

2.6.12.1 Application description

This application is subject to the following restrictions:

- The Component & Part Identifier is available for business processes where products are identified by the buyer. The buyer instructs his suppliers on how to identify and mark the products delivered to him.
- The identifier SHALL NOT be used in open supply chains. It is restricted to use by mutual agreement. The GTIN is the only GS1 standard identifier for trade items in open supply chains.

A Component / Part (C/P) is defined as an item that is intended to undergo at least one further transformation process to create finished goods for the purpose of downstream consumption. C/P examples may include:

- Drive motor for washing machine
- Fan assembly for a jet engine
- Pipe / tube
- Printed circuit board for television
- Starter motor for vehicle
- Magnetic coil for a Magnetic Resonance Imaging (MRI) machine
- Wheel axle

Several industry sectors use established systems for the identification of C/P in the supply chain. Very often, companies use alphanumeric identifiers for their C/P, which may be serialised. Many IT systems rely on the identifiers structure that includes limited meaningful information. Time-critical processes (material resource planning, delivery schedules, etc.) do not allow for a mapping of the identification schemes to other identifiers. In addition, there is often no ubiquitous network access available. Network failures can happen in reality and could lead to production interruptions which in turn lead to tremendous economic losses. For that reason, technical industries have implemented autonomous assembly lines, which are controlled by dedicated control terminals that need no permanent network access.

This application specifies a C/P Identifier that is available for the following processes:

- The C/P Identifier may be used by an OEM for their C/P procurement. The typical scenario is that an Original Equipment Manufacturer (OEM) assigns identifiers to Components / Parts necessary to build finished goods, such as automobiles. The C/P production is contracted to suppliers who use the C/P Identifier assigned by their customer, the OEM.
- The OEM and/or agents make use of the C/P Identifier in their production process.
- C/P Identifiers are also available to points of service for after sales services and maintenance activities, including procurement.

Note: GTIN remains the mandatory solution for items crossing aftermarket retail points of sale.

The following diagram illustrates the three main business processes where C/P Identifiers may be appropriate:

Figure 2.6.12.1-1. Business processes where C/P Identifiers may be appropriate

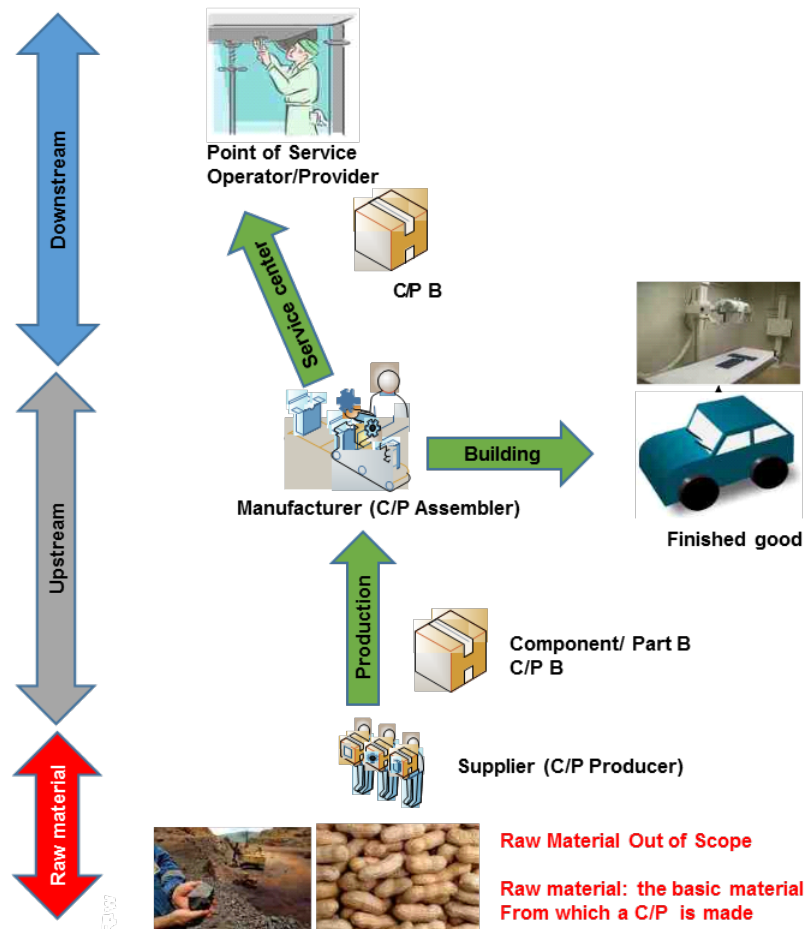

2.6.12.2 Identification requirements

Components / Parts that meet the requirements described above can be identified by a C/P Identifier that has the following characteristics:

- The C/P Identifier comprises a GS1 Company Prefix and C/P reference assigned by the GS1 Company Prefix holder.
- The C/P reference format is variable length. The Component / Part reference SHALL only consist of numeric, alphabetic upper-case or special characters "#", "-", or "/"
- The total length of the identifier SHALL NOT exceed 30 characters.
- The C/P Identifier would be classified as a "GS1 key" according to the current GS1 definitions. However it is not to be used in open supply chains but can be used as primary identifier in barcoding applications, EPC/RFID and EPCIS.

GS1 key

Definition

The C/P Identifier would be classified as a "GS1 key" according to the current GS1 definitions. However it is not to be used in open supply chains. The GS1 Application Identifier to indicate the Component / Part Identifier (CPID) is AI (8010) (see section [3.2](#) for a list of all GS1 Application Identifiers).

Rules

See above

Attributes

Required

Not applicable

Optional

The C/P Identifier may be supplemented by an optional serial number. The format of the serial number is numeric only, maximum 12 digits. See GS1 Application Identifier (8011) Component / Part Identifier in section 3.

Data carrier specification

Carrier choices

The GS1 data carriers that can be used to represent the C/P Identifier and the optional serial number are:

- GS1-128
- GS1 DataMatrix
- GS1 QR Code
- EPC/RFID

Data carrier specifications are to be provided by the OEM to its partners.

Symbol placement

Not applicable

Unique application processing requirements

Not applicable

2.7 Summary of applications and operative scanning environments for GS1 system symbols

The figure below provides a cross-reference for all system applications defined in section 2 and the GS1 symbol specification tables (SSTs) in section 5. The application where the barcode will be used SHALL be determined prior to locating the correct symbol specification table (SST) entry. Use the "SST(s)" column to find the SST appropriate for the application area. Because most application areas provide a reference to two symbol specification tables based on the operative scanning environment, a decision must be made between the two. See the decision tree figure 5.5.2.6.1 - 2 to determine the correct symbol specification table.

Figure 2.7-1. Areas of GS1 system application

Application	See section	SST(s)	Carrier choices
Fixed measure trade items – general retail consumer trade items scanned in general retail at POS:	2.1.2.1		
<ul style="list-style-type: none"> ▪ GTIN-12 and GTIN-13 	2.1.2.1.2	1	UPC-A, EAN-13, GS1 DataBar Retail POS family
<ul style="list-style-type: none"> ▪ GTIN-12 carried by a UPC-E barcode 	2.1.2.1.3	1	UPC-E
<ul style="list-style-type: none"> ▪ GTIN-8 carried by an EAN-8 barcode 	2.1.2.1.4	1	EAN-8, GS1 DataBar Retail POS family
<ul style="list-style-type: none"> ▪ Hardcover books and paperbacks: ISBN, GTIN-13, and GTIN-12 	2.1.2.1.5	1	EAN-13, UPC-A, UPC-E. Options: EAN/UPC 2-digit or 5-digit add-on symbols
<ul style="list-style-type: none"> ▪ Serial publications: ISSN, GTIN-13, and GTIN-12 	2.1.2.1.6	1	EAN-13, UPC-A, UPC-E. Options: EAN/UPC 2-digit or 5-digit add-on symbols
Fixed measure trade item - fresh food trade items scanned at POS	2.1.2.2	1	GS1 DataBar Omnidirectional, GS1 DataBar Stacked Omnidirectional, UPC-A, EAN-13, EAN-8
Trade Items intended for general distribution and POS	2.1.2.3	3	EAN/UPC, GS1 DataBar Retail POS family
Healthcare primary packaging (non-retail trade items)	2.1.2.4	6	GS1-128, GS1 DataMatrix, GS1 DataBar, EAN/UPC, ITF-14, Composite Component
Healthcare secondary packaging (regulated healthcare retail consumer trade items)	2.1.2.5	8 or 10	GS1-128, GS1 DataMatrix, GS1 DataBar, EAN/UPC, ITF-14, Composite Component
Trade items intended for general distribution scanning only	2.1.2.6	2	EAN/UPC, ITF-14, GS1-128, GS1 DataBar
<ul style="list-style-type: none"> ▪ Trade items intended for general distribution scanning only – regulated healthcare trade items 	2.1.2.6	8	GS1-128, GS1 DataBar, GS1 DataMatrix, EAN/UPC, ITF-14
<ul style="list-style-type: none"> ▪ Trade items intended for distribution scanning in manufacturing, maintenance, repair and overhaul processes. 	2.1.2.6	4	GS1-128, GS1 DataMatrix, GS1 QR Code
Medical devices (non-retail trade items)	2.1.2.7	7	GS1 DataMatrix
Fixed measure trade items packed in several individual pieces not scanned at POS	2.1.3	2, 4	GS1-128, GS1 DataMatrix, GS1 QR Code
<ul style="list-style-type: none"> ▪ Fixed measure trade items packed in several individual pieces not scanned at POS – Healthcare 	2.1.3	8 or 10	GS1-128
Direct marking	2.1.4	4, 7	GS1 DataMatrix, GS1 QR Code
Variable measure trade items – Packages/containers not scanned in general retail at POS	2.1.5	2	GS1-128, GS1 DataBar Expanded, GS1 DataBar Expanded Stacked, ITF-14
Fixed measure trade items – Restricted distribution	2.1.6		

Application	See section	SST(s)	Carrier choices
<ul style="list-style-type: none"> Company internal numbering – RCN-8 Prefix 0 or 2 	2.1.6.1	1	EAN-8
<ul style="list-style-type: none"> Company internal numbering – RCN- 13 GS1 Prefix 04 (RCN-12 U.P.C. Prefix 4) 	2.1.6.2	1	EAN-13, UPC-A
<ul style="list-style-type: none"> Company internal numbering – RCN- 12 U.P.C. Prefix 0 (LAC and RZSC) 	2.1.6.3	1	UPC-E
<ul style="list-style-type: none"> GS1 Prefixes 02, 20 to 29 - Restricted Circulation 	2.1.6.4	1	EAN-13 symbols
Variable measure fresh food trade items scanned at point-of-sale using GTIN	2.1.7.1	1	GS1 DataBar Expanded, GS1 DataBar Expanded Stacked
Variable measure trade items scanned at point-of-sale using Restricted Circulation Numbers	2.1.7.2	1	EAN-13, UPC-A
Trade Item extended packaging (general retail trade items)	2.1.8	1 Addendum for AI (8200)	GS1 DataMatrix, GS1 QR Code
<ul style="list-style-type: none"> Trade item extended packaging (regulated healthcare trade items) 	2.1.8	6, 7, 8, or 10	GS1 DataMatrix only
Logistics units - individual logistic units	2.2.1	5	GS1-128
Logistics units - multiple logistic units (GSIN, GINC)	2.2.2 , 2.2.3	2	GS1-128
Assets – Global Returnable Asset Identifier (GRAI)	2.3.1	9	GS1-128, GS1 DataMatrix, GS1 QR Code
<ul style="list-style-type: none"> Direct part marking of GRAI 	2.3.1 2.1.4	7	GS1 DataMatrix, GS1 QR Code
Assets – Global Individual Asset Identifier (GIAI)	2.3.2	9	GS1-128, GS1 DataMatrix, GS1 QR Code
<ul style="list-style-type: none"> Direct part marking of GIAI 	2.3.2 2.1.4	7	GS1 DataMatrix, GS1 QR Code
Locations and parties - Identification of a physical location	2.4.3.1	9	GS1-128, GS1 Data Matrix, GS1 QR Code, EPC/RFID
Service relationships	2.5	11	GS1-128, GS1 DataMatrix, GS1 QR Code
Coupons identified using the Global Coupon Number	2.6.2	1	GS1 DataBar Expanded, GS1 DataBar Expanded Stacked
Coupon identification for restricted geographic distribution (GS1 Prefix 99) GS1 common currency coupon identification (GS1 Prefixes 981 to 983)	2.6.3.3 2.6.3.4 2.6.3.5	1	EAN-13
Coupon code identification for use in North America (AI 8110, 8112)	2.6.3.6 2.6.3.7	(*)	GS1 DataBar Expanded, GS1 DataBar Expanded Stacked or digitally transmitted
Refund receipts	2.6.4	1	EAN-13
Electronic serial identifier for cellular mobile telephones (CMTI): AI(8002)	2.6.5	4	GS1-128
Payment slips	2.6.6	4	GS1-128
Customer specific articles	2.6.7	1	EAN-13, UPC-A, ITF-14, GS1-128
Custom trade item	2.6.8	4	GS1-128, GS1 DataBar, GS1 DataMatrix, GS1 QR Code
Global Document Type Identifier for document control	2.6.9	9	GS1-128, GS1 DataMatrix, GS1 QR Code
Internal applications	2.6.10	N/A	GS1-128, GS1 DataBar Expanded, GS1 DataMatrix, GS1 QR Code

Application	See section	SST(s)	Carrier choices
Consumer trade item production control	2.6.11	N/A	GS1 DataBar, GS1 DataMatrix, GS1 QR Code, GS1-128, Composite Component
Component / part identification	2.6.12	N/A	GS1-128, GS1 DataMatrix, GS1 QR Code
(*) See <i>US Coupon Application Guideline Using GS1 DataBar Expanded Symbols</i> for the appropriate SST.			



Note: GS1 DataBar has the capacity to carry GTIN-14, GTIN-14 is not intended for use at point-of-sale (POS) applications; therefore GS1 DataBar symbols for POS must not encode GTIN-14.

3 GS1 Application Identifier definitions

3.1	Introduction.....	128
3.2	GS1 Application Identifiers in numerical order.....	129
3.3	GS1 Application Identifiers starting with digit 0	134
3.4	GS1 Application Identifiers starting with digit 1	135
3.5	GS1 Application Identifiers starting with digit 2	139
3.6	GS1 Application Identifiers starting with digit 3	145
3.7	GS1 Application Identifiers starting with digit 4	151
3.8	GS1 Application Identifiers starting with digit 7	160
3.9	GS1 Application Identifiers starting with digit 8	169
3.10	GS1 Application Identifiers starting with digit 9	176
3.11	Compatibility of EPC Tag Data Standard and GS1 General Specifications	177

3.1 Introduction

This section describes the meaning, structure, and function of the GS1 system element strings so they can be correctly processed in users' application programmes. An element string is the combination of a GS1 Application Identifier and a GS1 Application Identifier data field. The allowable character set to be used for GS1 Application Identifier element strings is defined in section [7.11](#). There are AIs that have additional syntax restrictions, e.g. numerical only; see below definition for each AI.

Automatic processing of element strings in business applications requires information about the type of transaction to which the transferred data refers. See section 7 for an explanation of this process. Element strings can be carried by GS1-128, GS1 DataBar symbology, GS1 Composite, GS1 DataMatrix and GS1 QR Code symbols. The rules for use and interrelationships between the GS1 Application Identifiers are contained in section 2 and 4.

When a predefined length GS1 key and attributes are encoded together, the GS1 key SHOULD appear before the attributes. In most cases predefined length element strings SHOULD be followed by non-predefined element strings. The sequence of predefined and non-predefined element strings should be at the discretion of the creator of the element strings.

3.2 GS1 Application Identifiers in numerical order

Figure 3.2-1. GS1 Application Identifiers

AI	Data Content	Format (*)	FNC1 required (****)	Data title
00	Serial Shipping Container Code (SSCC)	N2+N18		SSCC
01	Global Trade Item Number (GTIN)	N2+N14		GTIN
02	GTIN of contained trade items	N2+N14		CONTENT
10	Batch or lot number	N2+X..20	(FNC1)	BATCH/LOT
11 (**)	Production date (YYMMDD)	N2+N6		PROD DATE
12 (**)	Due date (YYMMDD)	N2+N6		DUE DATE
13 (**)	Packaging date (YYMMDD)	N2+N6		PACK DATE
15 (**)	Best before date (YYMMDD)	N2+N6		BEST BEFORE or BEST BY
16 (**)	Sell by date (YYMMDD)	N2+N6		SELL BY
17 (**)	Expiration date (YYMMDD)	N2+N6		USE BY OR EXPIRY
20	Internal product variant	N2+N2		VARIANT
21	Serial number	N2+X..20	(FNC1)	SERIAL
22	Consumer product variant	N2+X..20	(FNC1)	CPV
240	Additional item identification	N3+X..30	(FNC1)	ADDITIONAL ID
241	Customer part number	N3+X..30	(FNC1)	CUST. PART NO.
242	Made-to-Order variation number	N3+N..6	(FNC1)	MTO VARIANT
243	Packaging component number	N3+X..20	(FNC1)	PCN
250	Secondary serial number	N3+X..30	(FNC1)	SECONDARY SERIAL
251	Reference to source entity	N3+X..30	(FNC1)	REF. TO SOURCE
253	Global Document Type Identifier (GDTI)	N3+N13+X..17	(FNC1)	GDTI
254	GLN extension component	N3+X..20	(FNC1)	GLN EXTENSION COMPONENT
255	Global Coupon Number (GCN)	N3+N13+N..12	(FNC1)	GCN
30	Variable count of items (variable measure trade item)	N2+N..8	(FNC1)	VAR. COUNT
310n (***)	Net weight, kilograms (variable measure trade item)	N4+N6		NET WEIGHT (kg)
311n (***)	Length or first dimension, metres (variable measure trade item)	N4+N6		LENGTH (m)
312n (***)	Width, diameter, or second dimension, metres (variable measure trade item)	N4+N6		WIDTH (m)
313n (***)	Depth, thickness, height, or third dimension, metres (variable measure trade item)	N4+N6		HEIGHT (m)
314n (***)	Area, square metres (variable measure trade item)	N4+N6		AREA (m ²)
315n (***)	Net volume, litres (variable measure trade item)	N4+N6		NET VOLUME (l)
316n (***)	Net volume, cubic metres (variable measure trade item)	N4+N6		NET VOLUME (m ³)
320n (***)	Net weight, pounds (variable measure trade item)	N4+N6		NET WEIGHT (lb)
321n (***)	Length or first dimension, inches (variable measure trade item)	N4+N6		LENGTH (i)
322n (***)	Length or first dimension, feet (variable measure trade item)	N4+N6		LENGTH (f)

AI	Data Content	Format (*)	FNC1 required (***)	Data title
323n (***)	Length or first dimension, yards (variable measure trade item)	N4+N6		LENGTH (y)
324n (***)	Width, diameter, or second dimension, inches (variable measure trade item)	N4+N6		WIDTH (i)
325n (***)	Width, diameter, or second dimension, feet (variable measure trade item)	N4+N6		WIDTH (f)
326n (***)	Width, diameter, or second dimension, yards (variable measure trade item)	N4+N6		WIDTH (y)
327n (***)	Depth, thickness, height, or third dimension, inches (variable measure trade item)	N4+N6		HEIGHT (i)
328n (***)	Depth, thickness, height, or third dimension, feet (variable measure trade item)	N4+N6		HEIGHT (f)
329n (***)	Depth, thickness, height, or third dimension, yards (variable measure trade item)	N4+N6		HEIGHT (y)
330n (***)	Logistic weight, kilograms	N4+N6		GROSS WEIGHT (kg)
331n (***)	Length or first dimension, metres	N4+N6		LENGTH (m), log
332n (***)	Width, diameter, or second dimension, metres	N4+N6		WIDTH (m), log
333n (***)	Depth, thickness, height, or third dimension, metres	N4+N6		HEIGHT (m), log
334n (***)	Area, square metres	N4+N6		AREA (m ²), log
335n (***)	Logistic volume, litres	N4+N6		VOLUME (l), log
336n (***)	Logistic volume, cubic metres	N4+N6		VOLUME (m ³), log
337n (***)	Kilograms per square metre	N4+N6		KG PER m ²
340n (***)	Logistic weight, pounds	N4+N6		GROSS WEIGHT (lb)
341n (***)	Length or first dimension, inches	N4+N6		LENGTH (i), log
342n (***)	Length or first dimension, feet	N4+N6		LENGTH (f), log
343n (***)	Length or first dimension, yards	N4+N6		LENGTH (y), log
344n (***)	Width, diameter, or second dimension, inches	N4+N6		WIDTH (i), log
345n (***)	Width, diameter, or second dimension, feet	N4+N6		WIDTH (f), log
346n (***)	Width, diameter, or second dimension, yard	N4+N6		WIDTH (y), log
347n (***)	Depth, thickness, height, or third dimension, inches	N4+N6		HEIGHT (i), log
348n (***)	Depth, thickness, height, or third dimension, feet	N4+N6		HEIGHT (f), log
349n (***)	Depth, thickness, height, or third dimension, yards	N4+N6		HEIGHT (y), log
350n (***)	Area, square inches (variable measure trade item)	N4+N6		AREA (i ²)
351n (***)	Area, square feet (variable measure trade item)	N4+N6		AREA (f ²)

AI	Data Content	Format (*)	FNC1 required (****)	Data title
352n (***)	Area, square yards (variable measure trade item)	N4+N6		AREA (y ²)
353n (***)	Area, square inches	N4+N6		AREA (i ²), log
354n (***)	Area, square feet	N4+N6		AREA (f ²), log
355n (***)	Area, square yards	N4+N6		AREA (y ²), log
356n (***)	Net weight, troy ounces (variable measure trade item)	N4+N6		NET WEIGHT (t)
357n (***)	Net weight (or volume), ounces (variable measure trade item)	N4+N6		NET VOLUME (oz)
360n (***)	Net volume, quarts (variable measure trade item)	N4+N6		NET VOLUME (q)
361n (***)	Net volume, gallons U.S. (variable measure trade item)	N4+N6		NET VOLUME (g)
362n (***)	Logistic volume, quarts	N4+N6		VOLUME (q), log
363n (***)	Logistic volume, gallons U.S.	N4+N6		VOLUME (g), log
364n (***)	Net volume, cubic inches (variable measure trade item)	N4+N6		VOLUME (i ³)
365n (***)	Net volume, cubic feet (variable measure trade item)	N4+N6		VOLUME (f ³)
366n (***)	Net volume, cubic yards (variable measure trade item)	N4+N6		VOLUME (y ³)
367n (***)	Logistic volume, cubic inches	N4+N6		VOLUME (i ³), log
368n (***)	Logistic volume, cubic feet	N4+N6		VOLUME (f ³), log
369n (***)	Logistic volume, cubic yards	N4+N6		VOLUME (y ³), log
37	Count of trade items	N2+N..8	(FNC1)	COUNT
390n (***)	Applicable amount payable or Coupon value, local currency	N4+N..15	(FNC1)	AMOUNT
391n (***)	Applicable amount payable with ISO currency code	N4+N3+N..15	(FNC1)	AMOUNT
392n (***)	Applicable amount payable, single monetary area (variable measure trade item)	N4+N..15	(FNC1)	PRICE
393n (***)	Applicable amount payable with ISO currency code (variable measure trade item)	N4+N3+N..15	(FNC1)	PRICE
394n (***)	Percentage discount of a coupon	N4+N4	(FNC1)	PRCNT OFF
400	Customer's purchase order number	N3+X..30	(FNC1)	ORDER NUMBER
401	Global Identification Number for Consignment (GINC)	N3+X..30	(FNC1)	GINC
402	Global Shipment Identification Number (GSIN)	N3+N17	(FNC1)	GSIN
403	Routing code	N3+X..30	(FNC1)	ROUTE
410	Ship to - Deliver to Global Location Number	N3+N13		SHIP TO LOC
411	Bill to - Invoice to Global Location Number	N3+N13		BILL TO
412	Purchased from Global Location Number	N3+N13		PURCHASE FROM
413	Ship for - Deliver for - Forward to Global Location Number	N3+N13		SHIP FOR LOC

AI	Data Content	Format (*)	FNC1 required (****)	Data title
414	Identification of a physical location - Global Location Number	N3+N13		LOC No
415	Global Location Number of the invoicing party	N3+N13		PAY TO
416	GLN of the production or service location	N3+N13		PROD/SERV LOC
420	Ship to - Deliver to postal code within a single postal authority	N3+X..20	(FNC1)	SHIP TO POST
421	Ship to - Deliver to postal code with ISO country code	N3+N3+X..9	(FNC1)	SHIP TO POST
422	Country of origin of a trade item	N3+N3	(FNC1)	ORIGIN
423	Country of initial processing	N3+N3+N..12	(FNC1)	COUNTRY - INITIAL PROCESS.
424	Country of processing	N3+N3	(FNC1)	COUNTRY - PROCESS.
425	Country of disassembly	N3+N3+N..12	(FNC1)	COUNTRY - DISASSEMBLY
426	Country covering full process chain	N3+N3	(FNC1)	COUNTRY - FULL PROCESS
427	Country subdivision Of origin	N3+X..3	(FNC1)	ORIGIN SUBDIVISION
7001	NATO Stock Number (NSN)	N4+N13	(FNC1)	NSN
7002	UN/ECE meat carcasses and cuts classification	N4+X..30	(FNC1)	MEAT CUT
7003	Expiration date and time	N4+N10	(FNC1)	EXPIRY TIME
7004	Active potency	N4+N..4	(FNC1)	ACTIVE POTENCY
7005	Catch area	N4+X..12	(FNC1)	CATCH AREA
7006	First freeze date	N4+N6	(FNC1)	FIRST FREEZE DATE
7007	Harvest date	N4+N6..12	(FNC1)	HARVEST DATE
7008	Species for fishery purposes	N4+X..3	(FNC1)	AQUATIC SPECIES
7009	Fishing gear type	N4+X..10	(FNC1)	FISHING GEAR TYPE
7010	Production method	N4+X..2	(FNC1)	PROD METHOD
7020	Refurbishment lot ID	N4+X..20	(FNC1)	REFURB LOT
7021	Functional status	N4+X..20	(FNC1)	FUNC STAT
7022	Revision status	N4+X..20	(FNC1)	REV STAT
7023	Global Individual Asset Identifier (GIAI) of an assembly	N4+X..30	(FNC1)	GIAI - ASSEMBLY
703s	Number of processor with ISO Country Code	N4+N3+X..27	(FNC1)	PROCESSOR # s
710	National Healthcare Reimbursement Number (NHRN) - Germany PZN	N3+X..20	(FNC1)	NHRN PZN
711	National Healthcare Reimbursement Number (NHRN) - France CIP	N3+X..20	(FNC1)	NHRN CIP
712	National Healthcare Reimbursement Number (NHRN) - Spain CN	N3+X..20	(FNC1)	NHRN CN
713	National Healthcare Reimbursement Number (NHRN) - Brasil DRN	N3+X..20	(FNC1)	NHRN DRN
... (****)	National Healthcare Reimbursement Number (NHRN) - Country "A" NHRN	N3+X..20	(FNC1)	NHRN xxx
8001	Roll products (width, length, core diameter, direction, splices)	N4+N14	(FNC1)	DIMENSIONS
8002	Cellular mobile telephone identifier	N4+X..20	(FNC1)	CMT No
8003	Global Returnable Asset Identifier (GRAI)	N4+N14+X..16	(FNC1)	GRAI
8004	Global Individual Asset Identifier (GIAI)	N4+X..30	(FNC1)	GIAI

AI	Data Content	Format (*)	FNC1 required (***)	Data title
8005	Price per unit of measure	N4+N6	(FNC1)	PRICE PER UNIT
8006	Identification of an individual trade item piece	N4+N14+N2+N2	(FNC1)	ITIP or GCTIN (*****)
8007	International Bank Account Number (IBAN)	N4+X..34	(FNC1)	IBAN
8008	Date and time of production	N4+N8+N..4	(FNC1)	PROD TIME
8010	Component / Part Identifier (CPID)	N4 + X..30	(FNC1)	CPID
8011	Component / Part Identifier serial number (CPID SERIAL)	N4 + N..12	(FNC1)	CPID SERIAL
8012	Software version	N4 + X..20	(FNC1)	VERSION
8017	Global Service Relation Number to identify the relationship between an organisation offering services and the provider of services	N4+N18	(FNC1)	GSRN - PROVIDER
8018	Global Service Relation Number to identify the relationship between an organisation offering services and the recipient of services	N4+N18	(FNC1)	GSRN - RECIPIENT
8019	Service Relation Instance Number (SRIN)	N4+N..10	(FNC1)	SRIN
8020	Payment slip reference number	N4+X..25	(FNC1)	REF No
8110	Coupon code identification for use in North America	N4+X..70	(FNC1)	-
8111	Loyalty points of a coupon	N4+N4	(FNC1)	POINTS
8112	Paperless coupon code identification for use in North America (AI 8112)	N4+X..70	(FNC1)	-
8200	Extended Packaging URL	N4+X..70	(FNC1)	PRODUCT URL
90	Information mutually agreed between trading partners	N2+X..30	(FNC1)	INTERNAL
91 to 99	Company internal information	N2+X..90	(FNC1)	INTERNAL

NOTES:

(*): The first position indicates the length (number of digits) of the GS1 Application Identifier. The following value refers to the format of the data content. The following convention is applied:

- n implied decimal point position
- N numeric digit
- X any character in [Figure 7.11-1](#)
- N3 3 numeric digits, predefined length
- N..3 up to 3 numeric digits
- X..3 up to 3 characters in [Figure 7.11-1](#)

(**): If only year and month are available, DD must be filled with two zeroes.

(***): The fourth digit of this GS1 Application Identifier indicates the number of decimal places (and in that way the implied decimal point position).

Example:

- 3100 Net weight in kg without a decimal point
- 3102 Net weight in kg with two decimal places

(****): All GS1 element strings that begin with GS1 Application Identifiers not contained in the predefined table shown in figure 5.10.1-2 SHALL be separated by a separator character unless this element string is the last one to be encoded in the symbol. For details on the separator character see section [7.8.3](#).

(*****): An example to illustrate future additional National Healthcare Reimbursement Numbers (NHRNs). If additional NHRN AIs are required, a request for a new NHRN AI SHALL be made through the GS1 GSMP.

(*****): ITIP is the preferred data title for AI (8006) and GCTIN will have a sunset date of January 2020.

3.3 GS1 Application Identifiers starting with digit 0

3.3.1 Identification of a logistic unit (SSCC): AI (00)

The GS1 Application Identifier (00) indicates that the GS1 Application Identifier data field contains an SSCC (Serial Shipping Container Code). The SSCC is used to identify logistic units (see section 2.2).

The extension digit is used to increase the capacity of the serial reference within the SSCC. It is assigned by the company that constructs the SSCC. The extension digit ranges from 0-9.

The GS1 Company Prefix is allocated by GS1 Member Organisations to the company that allocates the SSCC – here the physical builder or the brand owner of the logistic unit (see section 1.4.4). It makes the SSCC unique worldwide but does not identify the origin of the unit.

The structure and content of the serial reference is at the discretion of owner of the GS1 Company Prefix to uniquely identify each logistic unit.

The check digit is explained in section 7.9. Its verification, which must be carried out in the application software, ensures that the number is correctly composed.

Figure 3.3.1-1. Format of the element string

GS1 Application Identifier	SSCC (Serial Shipping Container Code)																	
	Extension digit	GS1 Company Prefix						Serial reference						Check digit				
0 0	N ₁	N ₂	N ₃	N ₄	N ₅	N ₆	N ₇	N ₈	N ₉	N ₁₀	N ₁₁	N ₁₂	N ₁₃	N ₁₄	N ₁₅	N ₁₆	N ₁₇	N ₁₈

The data transmitted from the barcode reader means that the element string denoting the SSCC of a logistic unit has been captured. When indicating this element string in the non-HRI text section of a barcode label, the following data title SHOULD be used (see also section 3.2): **SSCC**

3.3.2 Identification of a trade item (GTIN): AI (01)

The GS1 Application Identifier (01) indicates that the GS1 Application Identifier data field contains a GTIN. The GTIN is used to identify trade items (see section 4).

The GTIN for trade items may be a GTIN-8, GTIN-12, GTIN-13 or a GTIN-14. See section 2.1 for the rules for GTIN formats and mandatory or optional attributes in the various trade item applications.

The check digit is explained in section 7.9. Its verification, which must be carried out in the application software, ensures that the number is correctly composed.

Figure 3.3.2-1. Format of the element string

	GS1 Application Identifier	Global Trade Item Number (GTIN)													
		GS1-8 Prefix or GS1 Company Prefix						Item reference						Check digit	
(GTIN-8)	0 1	0	0	0	0	0	0	N ₁	N ₂	N ₃	N ₄	N ₅	N ₆	N ₇	N ₈
(GTIN-12)	0 1	0	0	N ₁	N ₂	N ₃	N ₄	N ₅	N ₆	N ₇	N ₈	N ₉	N ₁₀	N ₁₁	N ₁₂
(GTIN-13)	0 1	0	N ₁	N ₂	N ₃	N ₄	N ₅	N ₆	N ₇	N ₈	N ₉	N ₁₀	N ₁₁	N ₁₂	N ₁₃
(GTIN-14)	0 1	N ₁	N ₂	N ₃	N ₄	N ₅	N ₆	N ₇	N ₈	N ₉	N ₁₀	N ₁₁	N ₁₂	N ₁₃	N ₁₄

The data transmitted from the barcode reader means that the element string denoting the GTIN of a fixed measure trade item has been captured.

When indicating this element string in the non-HRI text section of a barcode label, the following data title SHOULD be used (see also section 3.2): **GTIN**

3.3.3 Identification of trade items contained in a logistic unit: AI (02)

The GS1 Application Identifier (02) indicates that the GS1 Application Identifier data field includes the GTIN of the contained trade items. The GTIN is used to identify trade items (see section 4).

The GTIN for trade items may be a GTIN-8, GTIN-12, GTIN-13 or a GTIN-14. See section 2 for the rules for GTIN formats and mandatory or optional attributes in the various trade item applications.

The GTIN of the trade items contained is the GTIN of the highest level of trade item contained in the logistic unit.

Note: This element string SHALL be used only on a logistic unit if:

- the logistic unit is not itself a trade item; and
- all trade items that are contained at the highest level have the same GTIN.

The check digit is explained in section 7.9. Its verification, which must be carried out in the application software, ensures that the number is correctly composed.

Figure 3.3.3-1. Format of the element string

	GS1 Application Identifier	Global Trade Item Number (GTIN)													Check digit
		GS1-8 Prefix or GS1 Company Prefix						Item reference							
(GTIN-8)	0 2	0	0	0	0	0	0	N ₁	N ₂	N ₃	N ₄	N ₅	N ₆	N ₇	N ₈
(GTIN-12)	0 2	0	0	N ₁	N ₂	N ₃	N ₄	N ₅	N ₆	N ₇	N ₈	N ₉	N ₁₀	N ₁₁	N ₁₂
(GTIN-13)	0 2	0	N ₁	N ₂	N ₃	N ₄	N ₅	N ₆	N ₇	N ₈	N ₉	N ₁₀	N ₁₁	N ₁₂	N ₁₃
(GTIN-14)	0 2	N ₁	N ₂	N ₃	N ₄	N ₅	N ₆	N ₇	N ₈	N ₉	N ₁₀	N ₁₁	N ₁₂	N ₁₃	N ₁₄

The data transmitted from the barcode reader means that the element string denoting the GTIN of trade items contained in a logistic unit has been captured. This element string must be processed together with the count of trade items, AI (37), which must appear on the same unit (see section 3.6.5). When indicating this element string in the non-HRI text section of a barcode label, the following data title SHOULD be used (see also section 3.2): **CONTENT**

3.4 GS1 Application Identifiers starting with digit 1

3.4.1 Batch or lot number: AI (10)

The GS1 Application Identifier (10) indicates that the GS1 Application Identifier data field contains a batch or lot number. The batch or lot number associates an item with information the manufacturer considers relevant for traceability of the trade item to which the element string is applied. The data may refer to the trade item itself or to items contained. The number may be, for example, a production lot number, a shift number, a machine number, a time, or an internal production code. The data is alphanumeric and may include all characters contained in [Figure 7.11-1](#).

Note: The batch or lot number is not part of the unique identification of a trade item.

Figure 3.4.1-1. Format of the element string

GS1 Application Identifier	Batch or lot number
1 0	X ₁ → variable length → X ₂₀

The data transmitted by the barcode reader means that the element string denoting a batch or lot number has been captured. As this element string is an attribute of a particular item, it must be processed together with the GTIN of the trade item to which it relates. When indicating this element

string in the non-HRI text section of a barcode label, the following data title SHOULD be used (see also section 3.2): **BATCH/LOT**

3.4.2 Production date: AI (11)

The GS1 Application Identifier (11) indicates that the GS1 Application Identifier data field contains a production date. The production date is the production or assembly date determined by the manufacturer. The date may refer to the trade item itself or to items contained. The structure is:

- Year: the tens and units of the year (e.g., 2003 = 03), which is mandatory.
- Month: the number of the month (e.g., January = 01), which is mandatory.
- Day: the number of the day of the relevant month (e.g., second day = 02); if it is not necessary to specify the day, the field must be filled with two zeros.

✔ **Note:** When it is not necessary to specify the day (the day field is filled with two zeros), the resultant data string shall be interpreted as the last day of the noted month including any adjustment for leap years (e.g. "130200" is "2013 February 28", "160200" is "2016 February 29", etc.).

✔ **Note:** This element string can only specify dates ranging from 49 years in the past to 50 years in the future. Determination of the correct century is explained in section 7.12.

Figure 3.4.2-1. Format of the element string

GS1 Application Identifier	Production date		
	Year	Month	Day
1 1	N ₁ N ₂	N ₃ N ₄	N ₅ N ₆

The data transmitted from the barcode reader means that the element string denoting a production date has been captured. As this element string is an attribute of a trade item, it must be processed together with the GTIN of the trade item to which it relates. When indicating this element string in the non-HRI text section of a barcode label, the following data title SHOULD be used (see also section 3.2): **PROD DATE**

3.4.3 Due date for amount on payment slip: AI (12)

The GS1 Application Identifier (12) indicates that the GS1 Application Identifier data field contains the date by which an invoice should be paid. This data element represents an attribute of a payment slip reference number, AI (8020), and a Global Location Number (GLN) of the invoicing party. The structure is:

- Year: the tens and units of the year (e.g., 1998 = 98), which is mandatory.
- Month: the number of the month (e.g., January = 01), which is mandatory.
- Day: the number of the day of the relevant month (e.g., second day = 02); if it is not necessary to specify the day, the field must be filled with two zeros.

✔ **Note:** When it is not necessary to specify the day (the day field is filled with two zeros), the resultant data string SHALL be interpreted as the last day of the noted month including any adjustment for leap years (e.g. "130200" is "2013 February 28", "160200" is "2016 February 29", etc.).

✔ **Note:** This element string can only specify dates ranging from 49 years in the past to 50 years in the future. Determination of the correct century is explained in section 7.12.

Figure 3.4.3-1. Format of the element string

GS1 Application Identifier	Due date		
	Year	Month	Day
1 2	N ₁ N ₂	N ₃ N ₄	N ₅ N ₆

The data transmitted from the barcode reader means that the element string denoting a due date has been captured. This element string must be processed together with a payment slip reference number, AI (8020), and a GLN of the invoicing party, AI (415).

When indicating this element string in the non-HRI text section of a barcode label, the following data title SHOULD be used (see also section [3.2](#)): **DUE DATE**

3.4.4 Packaging date: AI (13)

The GS1 Application Identifier (13) indicates that the GS1 Application Identifier data fields contain a packaging date. The packaging date is the date when the goods were packed as determined by the packager. The date may refer to the trade item itself or to items contained. The structure is:

- Year: the tens and units of the year (e.g., 2003 = 03), which is mandatory.
- Month: the number of the month (e.g., January = 01), which is mandatory.
- Day: the number of the day of the relevant month (e.g., second day = 02); if it is not necessary to specify the day, the field must be filled with two zeros.

✓ **Note:** When it is not necessary to specify the day (the day field is filled with two zeros), the resultant data string shall be interpreted as the last day of the noted month including any adjustment for leap years (e.g. "130200" is "2013 February 28", "160200" is "2016 February 29", etc.).

✓ **Note:** This element string can only specify dates ranging from 49 years in the past to 50 years in the future. Determination of the correct century is explained in section [7.12](#).

Figure 3.4.4-1. Format of the element string

GS1 Application Identifier	Packaging date		
	Year	Month	Day
1 3	N ₁ N ₂	N ₃ N ₄	N ₅ N ₆

The data transmitted from the barcode reader means that the element string denoting a packaging date has been captured. As this element string is an attribute of a trade item, it must be processed together with the GTIN of the trade item to which it relates. When indicating this element string in the non-HRI text section of a barcode label, the following data title SHOULD be used (see also section [3.2](#)): **PACK DATE**

3.4.5 Best before date: AI (15)

The GS1 Application Identifier (15) indicates that the GS1 Application Identifier data fields contain a best before date. Best before date on the label or package signifies the end of the period under which the product will retain specific quality attributes or claims even though the product may continue to retain positive quality attributes after this date. Best before date is primarily used for consumer information and may be a regulatory requirement.

✓ **Note:** A retailer may use this to determine a date that after which, they will no longer merchandise the product. Currently, there are implementations of best before date which are interpreted in their processes as date to Sell By.

The structure is:

- Year: the tens and units of the year (e.g., 2003 = 03), which is mandatory.
 - Month: the number of the month (e.g., January = 01), which is mandatory.
 - Day: the number of the day of the relevant month (e.g., second day = 02); if it is not necessary to specify the day, the field must be filled with two zeros.
- ✓ **Note:** When it is not necessary to specify the day (the Day field is filled with two zeros), the resultant data string SHALL be interpreted as the last day of the noted month including any adjustment for leap years (e.g. "130200" is "2013 February 28", "160200" is "2016 February 29", etc.).
- ✓ **Note:** This element string can only specify dates ranging from 49 years in the past to 50 years in the future. Determination of the correct century is explained in section [7.12](#).

Figure 3.4.5-1. Format of the element string

GS1 Application Identifier	Best before date		
	Year	Month	Day
1 5	N ₁ N ₂	N ₃ N ₄	N ₅ N ₆

The data transmitted from the barcode reader means that the element string denoting a best before date has been captured. As this element string is an attribute of a trade item, it must be processed together with the GTIN of the trade item to which it relates.

When indicating this element string in the non-HRI text section of a barcode label, the following data title SHOULD be used (see also section [3.2](#)): **BEST BEFORE** or **BEST BY**

3.4.6 Sell by date: AI (16)

The GS1 Application Identifier (16) indicates the date specified by the manufacturer as the last date the retailer is to offer the product for sale to the consumer. The product should not be merchandised after this date.

- ✓ **Note:** This AI is to be used in sectors where the manufacturer has agreed to apply the SELL BY date for the customer's use.

The structure is:

- Year: the tens and units of the year (e.g., 2003 = 03), which is mandatory.
 - Month: the number of the month (e.g., January = 01), which is mandatory.
 - Day: the number of the day of the relevant month (e.g., second day = 02); if it is not necessary to specify the day, the field must be filled with two zeros.
- ✓ **Note:** This element string can only specify dates ranging from 49 years in the past to 50 years in the future. Determination of the correct century is explained in section [7.12](#).

Figure 3.4.6-1. Format of the element string

GS1 Application Identifier	Sell by date		
	Year	Month	Day
1 6	N ₁ N ₂	N ₃ N ₄	N ₅ N ₆

The data transmitted from the barcode reader means that the element string denoting a sell by date has been captured. As this element string is an attribute of a trade item, it must be processed together with the GTIN of the trade item to which it relates.

When indicating this element string in the non-HRI text section of a barcode label, the following data title SHOULD be used (see also section [3.2](#)): **SELL BY**

3.4.7 Expiration date: AI (17)

The GS1 Application Identifier (17) indicates that the GS1 Application Identifier data fields contain an expiration date. The expiration date is the date that determines the limit of consumption or use of a product / coupon. Its meaning is determined based on the trade item context (e.g., for food, the date will indicate the possibility of a direct health risk resulting from use of the product after the date, for pharmaceutical products, it will indicate the possibility of an indirect health risk resulting from the ineffectiveness of the product after the date). It is often referred to as "use by date" or "maximum durability date."

The structure is:

- Year: the tens and units of the year (e.g., 2003 = 03), which is mandatory.
- Month: the number of the month (e.g., January = 01), which is mandatory.
- Day: the number of the day of the relevant month (e.g., second day = 02); if it is not necessary to specify the day, the field must be filled with two zeros.

✔ **Note:** When it is not necessary to specify the day (the day field is filled with two zeros), the resultant data string SHALL be interpreted as the last day of the noted month including any adjustment for leap years (e.g. "130200" is "2013 February 28", "160200" is "2016 February 29", etc.).

✔ **Note:** This element string can only specify dates ranging from 49 years in the past to 50 years in the future. Determination of the correct century is explained in section [7.12](#).

Figure 3.4.7-1. Format of the element string

GS1 Application Identifier	Expiration date		
	Year	Month	Day
1 7	N ₁ N ₂	N ₃ N ₄	N ₅ N ₆

The data transmitted from the barcode reader means that the element string denoting an expiration date has been captured. As this element string is an attribute of a trade item or a coupon, it must be processed together with the GTIN of the trade item or the Global Coupon Number (GCN) to which it relates.

When indicating this element string in the non-HRI text section of a barcode label, the following data title SHOULD be used (see also section [3.2](#)): **USE BY or EXPIRY**

3.5 GS1 Application Identifiers starting with digit 2

3.5.1 Internal product variant: AI (20)

This element string may be used to distinguish an internal product variant from the usual item if the variation is not sufficiently significant to require a separate Global Trade Item Number (GTIN) and the variation is relevant only to the brand owner and any third party acting on its behalf.

The internal product variant is only for use by the brand owner and any third party acting on its behalf and not for dealings with any other trading partners. The product variant SHALL NOT be used where the variation would trigger the allocation of a different GTIN per the *GTIN Management Standard*.

Although the element string will not have meaning to all trading partners, the element string may remain on the item throughout distribution.

Figure 3.5.1-1. Format of the element string

GS1 Application Identifier	Internal product variant
2 0	N ₁ N ₂

The GS1 Application Identifier (20) indicates that the data field contains an internal product variant number.

The internal product variant number must only be assigned by the brand owner. It forms a subsidiary numbering facility that can be used in addition to the item’s GTIN and allows the creation of 100 variants of a particular item.

The data transmitted from the barcode reader means that the element string denoting an internal product variant has been captured. The internal product variant must be processed together with the GTIN of the same trade item. Beyond the brand owner and any third party acting on its behalf, it should be ignored. When indicating this element string in the non-HRI text section of a barcode label, the following data title SHOULD be used (see also section 3.2): **VARIANT**

3.5.2 Serial number: AI (21)

The GS1 Application Identifier (21) indicates that the GS1 Application Identifier data field contains a serial number. A serial number is assigned to an entity for its lifetime. When combined with a GTIN, a serial number uniquely identifies an individual item. The serial number field is alphanumeric and may include all characters contained in [Figure 7.11-1](#). The manufacturer determines the serial number.

Figure 3.5.2-1. Format of the element string

GS1 Application Identifier	Serial number
2 1	X ₁ ————— variable length —————> X ₂₀

The data transmitted from the barcode reader means that the element string denoting a serial number has been captured. As this element string is an attribute of a trade item, it must be processed together with the GTIN of the trade item to which it relates.

When indicating this element string in the non-HRI text section of a barcode label, the following data title SHOULD be used (see also section 3.2): **SERIAL**

3.5.3 Consumer product variant: AI (22)

This element string may be used to distinguish one variant of a retail consumer trade item from another if the change does not require the allocation of a different Global Trade Item Number (per the GTIN Management Standard), but communication between trading partners is required to support consumers. The brand owner is responsible for assigning the consumer product variant. The data is alphanumeric and may include all characters contained in [Figure 7.11-1](#).

Figure 3.5.3-1. Format of the element string

GS1 Application Identifier	Consumer product variant
2 2	X ₁ ————— variable length —————> X ₂₀

The GS1 Application Identifier (22) indicates that the data field contains a consumer product variant.

 **Note:** The consumer product variant, AI (22), differs from the internal product variant, element string AI (20), which is relevant only to the brand owner and any third party acting on its behalf.

The data transmitted from the barcode reader means that the element string denoting a consumer product variant has been captured. The consumer product variant must be processed together with the GTIN of the same retail consumer trade item.

When indicating this element string in the non-HRI text section of a barcode label, the following data title SHOULD be used (see also section 3.2): **CPV**

3.5.4 Additional product identification assigned by the manufacturer: AI (240)

The GS1 Application Identifier (240) indicates that the GS1 Application Identifier data field contains additional item identification. The purpose of this element string is to enable identification data other than the Global Trade Item Number (GTIN) to be represented in a GS1 system data carrier. It is a cross-reference to previously used catalogue numbers. The additional item identification is considered an attribute of the GTIN (e.g., it facilitates migration to the GS1 system during a transitional period). However, it must not be used to replace the GTIN.

The additional item identification field is alphanumeric and may include all characters contained in [Figure 7.11-1](#). Its content and structure are at the discretion of the company applying the element string.

Figure 3.5.4-1. Format of the element string

GS1 Application Identifier	Additional item identification
2 4 0	X ₁ ————— variable length —————> X ₃₀

The data transmitted from the barcode reader means that the element string denoting an additional item identification has been captured. This element string must be processed together with the GTIN of the same trade item.

When indicating this element string in the non-HRI text section of a barcode label, the following data title SHOULD be used (see also section 3.2): **ADDITIONAL ID**

3.5.5 Customer part number: AI (241)

The GS1 Application Identifier (241) indicates that the GS1 Application Identifier data field contains a customer part number. The purpose of this element string is to enable identification data other than the Global Trade Item Number (GTIN) to be represented in a GS1 system data carrier. The element string SHOULD only be used between trading partners that are currently using the customer part number for ordering and who have agreed on a timetable to convert to the GTIN for their business purposes. Therefore, the use of the GTIN and the AI (241) on trade items is for transitional use during the conversion. The customer part number must not be used in place of the GTIN. The customer part number field is alphanumeric and may include all characters contained in [Figure 7.11-1](#).

Figure 3.5.5-1. Format of the element string

GS1 Application Identifier	Customer part number
2 4 1	X ₁ ————— variable length —————> X ₃₀

The data transmitted from the barcode reader means that the element string denoting a customer part number has been captured. This element string must be processed together with the GTIN of the same trade item. When indicating this element string in the non-HRI text section of a barcode label, the following data title SHOULD be used (see also section 3.2): **CUST. PART NO.**

3.5.6 Made-to-Order variation number: AI (242)

The GS1 Application Identifier (242) indicates that the data field contains a Made-to-Order variation number. The data is variable length numeric up to and including six digits.

The Made-to-Order variation number provides the additional data needed to uniquely identify a custom trade item (see section 2.6.8).

There is a mandatory association of AI 242 with a GTIN-14, indicator digit 9. This association indicates that the GTIN-14, indicator digit 9 represents a custom trade item when paired with AI (242).

A Made-to-Order variation number may not be used with the following GTINs: GTIN-8, GTIN-12, GTIN-13, and GTIN-14 indicator digit 1 through 8. The use of a GTIN-14, indicator digit 9 and a Made-to-Order variation number is only approved for the manufacturing and maintenance, repair & overhaul (MRO) environment.

Figure 3.5.6-1. Format of the element string

GS1 Application Identifier	Made-to-Order variation number
2 4 2	N ₁ ————— variable length—————> N ₆

The data transmitted by the barcode reader means that the element string denoting a Made-to-Order variation number has been captured. This element string must be processed together with the GTIN of the trade item to which it relates (see section [3.3.2](#)). When indicating this element string in the non-HRI text section of a barcode label, the following data title SHOULD also be used (see also section [3.2](#)): **MTO VARIANT**

3.5.7 Packaging component number: AI (243)

The GS1 Application Identifier (243) indicates the GS1 Application Identifier data field contains a Packaging Component Number (PCN). A PCN is assigned to the packaging component for its lifetime. When associated with a GTIN, a PCN uniquely identifies the relationship between a finished consumer trade item and one of its packaging components.

The current use case for PCN is for internal use only however the PCN may be considered in future use cases for open supply chain applications. The Packaging Component Number field is alphanumeric and may include all characters contained in [Figure 7.11-1](#).

Figure 3.5.7-1. Format of the element string

GS1 Application Identifier	Packaging Component Number
2 4 3	X ₁ —————> variable length—————> X ₂₀

The data transmitted from the barcode reader means that the element string denoting a Packaging Component Number has been captured. As this element string is an attribute of a particular item, it must be processed together with the GTIN of the trade item to which it relates.

When indicating this element string in the non-HRI text section of a barcode label, the following data title SHOULD be used (see also section [3.2](#)): **PCN**

3.5.8 Secondary serial number: AI (250)

The GS1 Application Identifier (250) indicates that the GS1 Application Identifier data field contains a secondary serial number. While the element string using AI (21) (see section [3.5.2](#)) contains the serial number of the trade item, the element string denoting a secondary serial number represents the serial number of a component of that item. The company applying the element string determines which component the element string refers to for a given trade item. The recognition of the meaning of the secondary serial number is accomplished via the GTIN and information provided by the issuer regarding the component to which the secondary serial number refers.

If this element string is being used, the trade item must be symbol marked with the following element strings:

- AI (01): representing the GTIN of the trade item.
- AI (21): representing the serial number of the trade item.
- AI (250): representing the serial number of a component of the trade item.

Only one element string with AI (250) may be associated with a particular GTIN.

The secondary serial number field is alphanumeric and may include all characters contained in [Figure 7.11-1](#). The number and to what component it relates is determined by the issuer.

Figure 3.5.8-1. Format of the element string

GS1 Application Identifier	Secondary serial number
2 5 0	X ₁ ————— variable length —————>X ₃₀

The data transmitted from the barcode reader means that the element string denoting a secondary serial number has been captured. This element string must be processed together with the GTIN of the trade item to which it relates and the serial number of the trade item AI (21). When indicating this element string in the non-HRI text section of a barcode label, the following data title SHOULD be used (see also section [3.2](#)): **SECONDARYSERIAL**



Note: The actual data title may be specified by the issuer of the data.

3.5.9 Reference to source entity: AI (251)

The GS1 Application Identifier (251) indicates that the GS1 Application Identifier data field consists of a reference to the original item. Reference to source entity is an attribute of a trade item used to refer to the original item from which the trade item was derived. The issuer of the trade item must indicate through other means the source entity to which the data refers.

For example, the original item could be an animal from which a carcass of beef is derived. This element string would enable reference to the original animal, so that, if the animal was found to be contaminated, all derived products could be isolated. In addition, this element string could also be used for regulatory compliance when recycling parts from various white goods, such as refrigerators, where it is necessary to refer to the original appliance. The reference to the source entity field is alphanumeric and may include all characters contained in [Figure 7.11-1](#).

Figure 3.5.9-1. Format of the element string

GS1 Application Identifier	Reference to source entity
2 5 1	X ₁ ————— variable length —————>X ₃₀

The data transmitted by the barcode reader means that the element string denoting a reference to source entity has been captured. As this element string is an attribute of a trade item, it must be processed together with the GTIN of the trade item to which it relates.

When indicating this element string in the non-HRI text section of a barcode label, the following data title SHOULD be used (see also section [3.2](#)): **REF. TO SOURCE**



Note: The actual data title may be specified by the issuer of the data.

3.5.10 Global Document Type Identifier (GDTI): AI (253)

The GS1 Application Identifier (253) indicates that the GS1 Application Identifier data field contains the Global Document Type Identifier (GDTI). The GDTI is used to identify a document type with an optional serial number.

The GS1 Company Prefix is allocated by GS1 Member Organisations to the company that allocates the GDTI – here the document issuer (see section [1.4.4](#)). It makes the number unique worldwide.

The structure and content of the Document Type is at the discretion of the document issuer, in order to uniquely identify each type of document.

The check digit is explained in section [7.9](#). Its verification, which must be carried out in the application software, ensures that the number is correctly composed.

The optional serial component is assigned to a single document for its lifetime. When the serial component is included, the GDTI uniquely identifies an individual document. The serial component field is alpha-numeric and may contain up to 17 characters. It may contain all characters contained in [Figure 7.11-1](#). The issuer of the document determines the serial component.

Figure 3.5.10-1. Format of the element string

GS1 Application Identifier	Global Document Type Identifier (GDTI)			
	GS1 Company Prefix →	Document type ←	Check digit	Serial component (optional)
2 5 3	N ₁ N ₂ N ₃ N ₄ N ₅ N ₆ N ₇ N ₈ N ₉ N ₁₀ N ₁₁ N ₁₂		N ₁₃	X ₁ —variable— X ₁₇

The data transmitted from the barcode reader means that the element string denoting a GDTI has been captured. When indicating this element string in the non-HRI text section of a barcode label, the following data title SHOULD be used (see also section 3.2): **GDTI**

3.5.11 GLN extension component: AI (254)

The GS1 Application Identifier (254) indicates that the data field contains an extension component of a Global Location Number (GLN). The use of AI (254) is optional, but when used it must appear in conjunction with AI (414), identification of a physical location.

The party who defined the location determines the extension component. Once determined, it is unchanged for the life of the associated GLN. The GLN extension component field is alphanumeric and may include all characters contained in [Figure 7.11-1](#).

Figure 3.5.11-1. Format of the element string

GS1 Application Identifier	GLN extension component
2 5 4	X ₁ ————— variable length —————> X ₂₀

The data transmitted from the reader means that the element string denoting an extension component of a GLN has been captured. As this element string is an attribute of a physical location, it must be processed together with the GLN, AI (414), to which it relates.

When indicating this element string in the non-HRI text section of a barcode label, the following data title SHOULD be used (see also section 3.2): **GLN EXTENSION COMPONENT**

3.5.12 Global Coupon Number (GCN): AI (255)

The GS1 Application Identifier (255) indicates that the GS1 Application Identifier data field contains the Global Coupon Number (GCN). The GCN provides a globally unique identification for a coupon, with an optional serial number.

The GS1 Company Prefix is allocated by GS1 Member Organisations to the company that allocates the GCN. It makes the number unique worldwide.

The structure and content of the coupon reference is at the discretion of the coupon issuer, in order to uniquely identify each type of coupon.

The check digit is explained in section 7.9. Its verification, which must be carried out in the application software, ensures that the number is correctly composed.

The optional serial component is assigned to an individual instance of a coupon. The combination of GS1 Company Prefix, coupon reference and serial component uniquely identifies an individual coupon. The serial component field is numeric and may contain up to 12 digits. The issuer of the Global Coupon Number determines the serial component.

Figure 3.5.12-1. Format of the element string

GS1 Application Identifier	Global Coupon Number (GCN)			
	GS1 Company Prefix →	Coupon reference ←	Check digit	Serial component (optional)
2 5 5	N ₁ N ₂ N ₃ N ₄ N ₅ N ₆ N ₇ N ₈ N ₉ N ₁₀ N ₁₁ N ₁₂		N ₁₃	N ₁ —variable—> N ₁₂

When indicating this element string in the non-HRI text section of a barcode label, the following data title SHOULD be used (see also section 3.2): **GCN**

3.6 GS1 Application Identifiers starting with digit 3

3.6.1 Variable count of items: AI (30)

The GS1 Application Identifier (30) indicates that the GS1 Application Identifier data field contains the number of items contained in a variable measure trade item. This element string is used to complete the identification of a variable measure trade item and, therefore, should never be applied in isolation.

The variable count of items field represents the quantity contained in the respective trade item. It is of variable length and may have up to eight digits.

 **Note:** This element string must not be used to indicate the contained quantity of a fixed measure trade item. However, if this element string appears on a fixed measure trade item (in error) it should not invalidate the item identification but should be treated as redundant data.

Figure 3.6.1-1. Format of the element string

GS1 Application Identifier	Variable count of items
3 0	N ₁ ———variable length ———>N ₈

The data transmitted from the barcode reader means that the element string denoting a quantity (variable count of items), which can be considered part of the identification of a variable measure trade item, has been captured. This element string must be processed with the GTIN of the trade item to which it relates (see section [3.3.2](#)).

When indicating this element string in the non-HRI text section of a barcode label, the following data title SHOULD be used (see also section [3.2](#)): **VAR. COUNT**

3.6.2 Trade measures: AIs (31nn, 32nn, 35nn, 36nn)

The GS1 Application Identifiers (digits A1 to A4 – see figure below) indicate that the GS1 Application Identifier data field contains the quantity or dimension of a variable measure trade item. It also denotes the unit of measure. These element strings are used to complete the identification of a variable measure trade item. They contain information such as the weight, size, volume, or dimension of a variable measure trade item and, therefore, should never be applied alone. Several element strings are possible if the variables required are dimensions or weights expressed in kilograms and pounds.

The GS1 Application Identifier digit A4 indicates the implied decimal point position, where, for example, the digit 0 means that there is no decimal point, and the digit 1 means that the decimal point is between N5 and N6. The “applicable value” field contains the variable measure that applies to the respective trade item.

Figure 3.6.2-1. Format of the element string

GS1 Application Identifier	Applicable value
A ₁ A ₂ A ₃ A ₄	N ₁ N ₂ N ₃ N ₄ N ₅ N ₆

The GS1 Application Identifiers used with this element string are shown in the figure below.

 **Note:** Other values of AI (3nnn) specify gross measures and logistic measures.

Figure 3.6.2-2. GS1 Application Identifiers for trade measures

A ₁	A ₂	A ₃	A ₄	Trade measure	Unit of measure
3	1	0	n	Net weight	Kilograms
3	1	1	n	Length or first dimension	Metres
3	1	2	n	Width, diameter, or second dimension	Metres

A ₁	A ₂	A ₃	A ₄	Trade measure	Unit of measure
3	1	3	n	Depth, thickness, height, or third dimension	Metres
3	1	4	n	Area	Square metres
3	1	5	n	Net volume	Litres
3	1	6	n	Net volume	Cubic metres
3	2	0	n	Net weight	Pounds
3	2	1	n	Length or first dimension	Inches
3	2	2	n	Length or first dimension	Feet
3	2	3	n	Length or first dimension	Yards
3	2	4	n	Width, diameter, or second dimension	Inches
3	2	5	n	Width, diameter, or second dimension	Feet
3	2	6	n	Width, diameter, or second dimension	Yards
3	2	7	n	Depth, thickness, height, or third dimension	Inches
3	2	8	n	Depth, thickness, height, or third dimension	Feet
3	2	9	n	Depth, thickness, height, or third dimension	Yards
3	5	0	n	Area	Square inches
3	5	1	n	Area	Square feet
3	5	2	n	Area	Square yards
3	5	6	n	Net weight	Troy ounces
3	5	7	n	Net weight (or volume)	Ounces
3	6	0	n	Net volume	Quarts
3	6	1	n	Net volume	Gallons (U.S.)
3	6	4	n	Net volume	Cubic inches
3	6	5	n	Net volume	Cubic feet
3	6	6	n	Net volume	Cubic yards

The data transmitted from the barcode reader means that the element string denoting a quantity, which can be considered part of the identification of a variable measure trade item, has been captured. This element string must be processed together with the GTIN of the trade item to which it relates (see section 3.3.2). When indicating this element string in the non-HRI text section of a barcode label, the data title in section 3.2 SHOULD be used.

3.6.3 Logistic measures: AIs (33nn, 34nn, 35nn, 36nn)

The GS1 Application Identifiers (A1 to A4 see figure below) indicate that the GS1 Application Identifier data field contains the logistic quantity or dimension of a logistic unit or a variable measure trade item. They also denote the unit of measure.

 **Note:** The GS1 system provides standards for logistic weights and measures in metric and other units of measure. In principle, a particular logistic measure SHOULD be applied in only one unit of measure on a given logistic unit. However, application of the same attribute in several units of measure does not impede the correct processing of the transmitted data.

The GS1 Application Identifier digit in field A4 indicates the implied decimal point position, where, for example, the digit 0 means that there is no decimal point, and the digit 1 means that the decimal point is between N5 and N6. The Applicable Value field represents the measures of the respective unit.

Figure 3.6.3-1. Format of the element string

GS1 Application Identifier				Applicable value					
A ₁	A ₂	A ₃	A ₄	N ₁	N ₂	N ₃	N ₄	N ₅	N ₆

The GS1 Application Identifiers used with this element string are shown in the figure below.

Figure 3.6.3-2. GS1 Application Identifiers for logistic measures

A ₁	A ₂	A ₃	A ₄	Definition of logistic measures	Unit of measure
3	3	0	n	Logistic weight	Kilograms
3	3	1	n	Length or first dimension	Metres
3	3	2	n	Width, diameter, or second dimension	Metres
3	3	3	n	Depth, thickness, height, or third dimension	Metres
3	3	4	n	Area	Square metres
3	3	5	n	Logistic volume	Litres
3	3	6	n	Logistic volume	Cubic metres
3	4	0	n	Logistic weight	Pounds
3	4	1	n	Length or first dimension	Inches
3	4	2	n	Length or first dimension	Feet
3	4	3	n	Length or first dimension	Yards
3	4	4	n	Width, diameter, or second dimension	Inches
3	4	5	n	Width, diameter, or second dimension	Feet
3	4	6	n	Width, diameter, or second dimension	Yards
3	4	7	n	Depth, thickness, height, or third dimension	Inches
3	4	8	n	Depth, thickness, height, or third dimension	Feet
3	4	9	n	Depth, thickness, height, or third dimension	Yards
3	5	3	n	Area	Square inches
3	5	4	n	Area	Square feet
3	5	5	n	Area	Square yards
3	6	2	n	Logistic volume	Quarts
3	6	3	n	Logistic volume	Gallons (U.S.)
3	6	7	n	Logistic volume	Cubic inches
3	6	8	n	Logistic volume	Cubic feet
3	6	9	n	Logistic volume	Cubic yards

The data transmitted from the barcode reader means that the element string denoting a logistic measure has been captured. This element string must be processed with the SSCC of the logistic unit or the GTIN of the variable measure trade item to which it relates. When indicating this element string in the non-HRI text section of a barcode label, the data title in section 3.2 SHOULD be used.

3.6.4 Kilograms per square metre: AI (337n)

The GS1 Application Identifier (337n) indicates that the GS1 Application Identifier data field contains the kilograms per square metre of a particular trade item.

The GS1 Application Identifier digit shown as “n” indicates the implied decimal point position, where, for example, the digit 0 means that there is no decimal point, and the digit 1 means that the decimal point is between N₅ and N₆.

The **kilograms per square metre** field contains the weight per area of the respective trade item. The unit of measure is kilograms.

Figure 3.6.4-1. Format of the element string

GS1 Application Identifier	Kilograms per square metre					
3 3 7 n	N ₁	N ₂	N ₃	N ₄	N ₅	N ₆

The data transmitted from the barcode reader means that the element string denoting kilograms per square metre has been captured. As this element string is an attribute of a trade item, it must be processed together with the GTIN of the trade item to which it relates.

When indicating this element string in the non-HRI text section of a barcode label, the following data title SHOULD be used (see also section 3.2): **KG PER m²**

3.6.5 Count of trade items contained in a logistic unit: AI (37)

The GS1 Application Identifier (37) indicates that the GS1 Application Identifier data field contains the number of trade items contained in a logistic unit. This element string is a mandatory completion of AI (02) described in section 3.3.3.

The count of trade items field contains the number of trade items contained in the respective logistic unit. This information refers to the identification number of the contained trade items.

Figure 3.6.5-1. Format of the element string

GS1 Application Identifier	Count of trade items
3 7	N ₁ —variable length—> N ₈

The data transmitted from the barcode reader means that the element string denoting a number of trade items contained in a logistic unit has been captured. This element string must be processed together with the GTIN represented in AI (02) (see section 3.3.3) appearing on the same logistic unit.

When indicating this element string in the non-HRI text section of a barcode label, the following data title SHOULD be used (see also section 3.2): **COUNT**

3.6.6 Amount payable or coupon value - Single monetary area: AI (390n)

The GS1 Application Identifier (390n) indicates that the GS1 Application Identifier data field contains the amount payable of a payment slip or the coupon value.

The GS1 Application Identifier digit shown as “n” indicates the implied decimal point position, where the digit 0 means that there is no decimal point, and the digit 1 means that the decimal point is before the last position of the amount payable. See examples in figure below.

The applicable amount payable contains the sum to be paid with the respective payment slip or the coupon value.

Figure 3.6.6-1. Format of the element string

GS1 Application Identifier	Applicable amount payable or coupon value
3 9 0 n	N ₁ —variable length—> N ₁₅

 **Note:** To aid unambiguous processing of payment slips, AI (391n), described in section 3.6.7, SHOULD be used to indicate the currency in which the amount is expressed.

The figure below shows examples of the decimal point indication.

Figure 3.6.6-2. Decimal point indication examples

GS1 Application Identifier	Encoded value	Actual value
3 9 0 2	1 2 3 4 5 6 7	1 2 3 4 5 . 6 7
3 9 0 1	1 2 3 4 5 6 7	1 2 3 4 5 6 . 7 0
3 9 0 0	1 2 3 4 5	1 2 3 4 5 . 0 0

The data string transmitted from the barcode reader means that the element string denoting the amount payable of a payment slip or the coupon value has been captured. This element string must be processed together with either:

- the payment slip reference number, AI (8020) and the GLN of the invoicing party, AI (415).
- the Global Coupon Number, AI (255).

When indicating this element string in the non-HRI text section of a barcode label, the following data title SHOULD be used (see also section 3.2): **AMOUNT**

3.6.7 Amount payable and ISO currency code: AI (391n)

The GS1 Application Identifier (391n) indicates that the GS1 Application Identifier data fields consist of an ISO currency code and an applicable amount payable.

The GS1 Application Identifier digit shown as “n” indicates the implied decimal point position in the applicable amount payable field, where the digit 0 means that there is no decimal point, and the digit 1 means that the decimal point is before the last position of the amount payable. See examples in the figure below.

The ISO country code field contains the three-digit currency number of the numerical international standard *ISO 4217* and indicates the currency in which the amount payable is expressed. The applicable amount payable contains the sum to be paid with the respective payment slip.

Figure 3.6.7-1. Format of the element string

GS1 Application Identifier	ISO currency code	Applicable amount payable
3 9 1 n	N ₁ N ₂ N ₃	N ₄ ———variable length ——>N ₁₈

Figure 3.6.7-2 shows examples of the decimal point indication.

Figure 3.6.7-2. Decimal point indication examples

GS1 Application Identifier	ISO currency code	Encoded value	Actual value
3 9 1 2	7 1 0*	1 2 3 0	1 2 . 3 0
3 9 1 1	7 1 0*	1 2 3 0	1 2 3 . 0 0
3 9 1 0	9 7 8**	1 2 3	1 2 3 . 0 0
* South African Rand ** Euro			

The data string transmitted from the barcode reader means that the element string denoting the amount payable has been captured. This element string must be processed together with the payment slip reference number, AI (8020), and the GLN of the invoicing party, AI (415).

When indicating this element string in the non-HRI text section of a barcode label, the following data title SHOULD be used (see also section 3.2): **AMOUNT**

3.6.8 Amount payable for a variable measure trade item – Single monetary area: AI (392n)

The GS1 Application Identifier (392n) indicates that the GS1 Application Identifier data field contains the amount payable for a variable measure trade item.

The amount payable refers to an item identified by the Global Trade Item Number (GTIN) of a variable measure trade item and is expressed in local currency. This AI is an attribute of the GTIN and is always used in conjunction with it.

The GS1 Application Identifier digit shown as “n” indicates the implied decimal point position, where the digit 0 means that there is no decimal point, and the digit 1 means that the decimal point is before the last position of the amount payable. See examples in the figure below.

The applicable amount payable field contains the total to be paid for the variable measure trade item.

Figure 3.6.8-1. Format of the element string

GS1 Application Identifier	Applicable amount payable
3 9 2 n	N ₁ ——variable length——>N ₁₅

Figure 3.6.8-2. Decimal point indication examples

GS1 Application Identifier	Encoded value	Actual value
3 9 2 2	1 2 3 4 5 6 7	1 2 3 4 5 . 6 7
3 9 2 1	1 2 3 4 5 6 7	1 2 3 4 5 6 . 7 0
3 9 2 0	1 2 3 4 5	1 2 3 4 5 . 0 0

The data transmitted by the barcode reader means that the element string denoting the amount payable of a variable measure trade item has been captured. As this element string is an attribute of a trade item, it must be processed together with the GTIN of the trade item to which it relates. When indicating this element string in the non-HRI text section of a barcode label, the following data title SHOULD be used (see section 3.2): **PRICE**

3.6.9 Amount payable for a variable measure trade item and ISO currency code: AI (393n)

The GS1 Application Identifier (393n) indicates that the GS1 Application Identifier data field consists of an ISO currency code and an applicable amount payable. The amount payable refers to an item identified with the Global Trade Item Number (GTIN) of a variable measure trade item and is expressed in the indicated currency. This AI is an attribute of the GTIN and is always expressed in conjunction with it.

The GS1 Application Identifier digit shown as “n” indicates the implied decimal point in the applicable amount payable Field, where the digit 0 means that there is no decimal point, and the digit 1 means that the decimal point is before the last position of the amount payable. See examples in the figure below.

The ISO currency code field contains the three-digit currency number of the numerical international standard *ISO/IEC 4217* and indicates the currency in which the amount payable is expressed. The applicable amount payable field contains the sum to be paid for the variable measure trade item.

Figure 3.6.9-1. Format of the element string

GS1 Application Identifier	ISO currency code	Applicable amount payable
3 9 3 n	N ₁ N ₂ N ₃	N ₄ ——variable length——>N ₁₈

Figure 3.6.9-2. Decimal point indication examples

GS1 Application Identifier	ISO currency code	Encoded value	Actual value
3 9 3 2	7 1 0*	1 2 3 0	1 2 . 3 0
3 9 3 1	7 1 0*	1 2 3 0	1 2 3 . 0 0
3 9 3 0	9 7 8**	1 2 3	1 2 3 . 0 0
* South African Rand		** Euro	

The data transmitted by the barcode reader means that the element string denoting the amount payable of a variable measure trade item has been captured. As this element string is an attribute of a trade item, it must be processed together with the GTIN of the trade item to which it relates. When indicating this element string in the non-HRI text section of a barcode label, the following data title SHOULD be used (see also section 3.2): **PRICE**

3.6.10 Percentage discount of a coupon: AI (394n)

The GS1 Application Identifier (394n) indicates that the GS1 Application Identifier data field contains the percentage discount of a coupon.

The GS1 Application Identifier digit shown as "n" indicates the implied decimal point position, where the digit 0 means that there is no decimal point, and the digit 1 means that the decimal point is before the last position of the amount payable. See examples in figure below.

Figure 3.6.10-1. Format of the element string

GS1 Application Identifier	Percentage discount of a coupon
3 9 4 n	N ₁ N ₂ N ₃ N ₄

The data string transmitted from the barcode reader means that the element string denoting the percentage to be taken off the purchase amount has been captured. The purchase amount on which the percentage discount would be granted depends on the conditions of the promotion (can be the purchase value of one item, can be the purchase value of a bundle of items or can even be on the total purchase value).

The figure below shows examples of the decimal point indication.

Figure 3.6.10-2. Decimal point indication examples

GS1 Application Identifier	Encoded value	Actual value
3 9 4 0	0 0 1 0	10 %
3 9 4 1	0 0 5 5	5.5 %

This element string must be processed together with the Global Coupon Number, AI (255) of the coupon to which it relates.

When indicating this element string in the non-HRI text section of a barcode label, the following data title SHOULD be used (see also section [3.2](#)): **PRCNT OFF**

3.7 GS1 Application Identifiers starting with digit 4

3.7.1 Customer's purchase order number: AI (400)

The GS1 Application Identifier (400) indicates that the GS1 Application Identifier data field contains the customer's purchase order number, restricted for use between two trading partners.

The customer's purchase order number field is alphanumeric and may include all characters contained in [Figure 7.11-1](#). It contains the number of the purchase order assigned by the company that issued the order. The composition and content of the order number is left to the discretion of the customer. For example, the purchase order number may include release and line numbers.

Figure 3.7.1-1. Format of the element string

GS1 Application Identifier	Customer's purchase order number
4 0 0	X ₁ ————variable length————>X ₃₀

The data transmitted by the barcode reader means that the element string denoting a customer's purchase order number has been captured. This element string may be processed as stand-alone information where applicable or processed together with the GS1 identification number of the same unit.

! **Important:** This element string must be removed from the unit before the unit leaves the premises of the customer.

When indicating this element string in the non-HRI text section of a barcode label, the following data title SHOULD be used (see also section [3.2](#)): **ORDER NUMBER**

3.7.2 Global Identification Number for Consignment (GINC): AI (401)

The GS1 Application Identifier (401) indicates that the GS1 Application Identifier data field contains a Global Identification Number for Consignment (GINC). This number identifies a logical grouping of goods (one or more physical entities) that has been consigned to a freight forwarder and is intended to be transported as a whole. The consignment number must be allocated by a freight forwarder (or a carrier acting as a freight forwarder) or a consignor, but only if prior agreement of the freight forwarder is given. Typically AI (401) encodes a house waybill number.

According to the *GS1 Logistics Interoperability Model (LIM)*³, a freight forwarder is a party that arranges the carriage of goods, including connected services and/or associated formalities, on behalf of a shipper or consignee. A carrier is a party that undertakes the transportation of goods from one point to another. A consignor is the party that sends the goods. A consignee is the party that receives the goods.

The GS1 Company Prefix is allocated by GS1 Member Organisations to the company that allocates the GINC – here the carrier (see section 1.4.4). It makes the number unique worldwide.

The structure and content of the consignment reference is at the discretion of the carrier, in order to uniquely identify each consignment. It may contain all characters contained in [Figure 7.11-1](#).

Figure 3.7.2-1. Format of the element string

GS1 Application Identifier	Global Identification Number for Consignment (GINC)				
	GS1 Company Prefix		Consignment reference		
4 0 1	N ₁ ...	N _i	X _{i+1} ...	variable length	X _{j (j<=30)}

The data transmitted by the barcode reader means the element string denoting a GINC has been captured.



Note: If a new consignment is created, previously consignment number barcodes must be removed from the physical units.

When indicating this element string in the non-HRI text section of a barcode label, the following data title SHOULD be used (see also section 3.2): **GINC**

3.7.3 Global Shipment Identification Number (GSIN): AI (402)

The GS1 Application Identifier (402) indicates that the data field contains a Global Shipment Identification Number (GSIN).

The Global Shipment Identification Number (GSIN) is a number assigned by a consignor (seller) of goods. It provides a globally unique number that identifies a logical grouping of logistic units for the purpose of a transport shipment from that consignor (seller) to the consignee (buyer). It identifies the logical grouping of one or several logistic units each identified with an separate SSCC and containing trade items as being part of a specific seller / buyer relationship and that travels under one despatch advice and/or Bill of Lading. It may be used by all parties in the transport chain as a communication reference, for example, in Electronic Data Interchange (EDI) messages where it can be used as a shipment reference and/or a consignor’s loading list. The GSIN fulfils the requirements of the UCR (Unique Consignment Reference) of the World Customs Organisation (WCO).

The GS1 Company Prefix is allocated by GS1 Member Organisations to the company that allocates the GSIN – here the shipper (sender) (see section 1.4.4). It makes the number unique worldwide.

The structure and content of the shipper reference is at the discretion of the shipper, in order to uniquely identify each shipment. It SHOULD be sequentially allocated.

The check digit is explained in section 7.9. Its verification, which must be carried out in the application software, ensures that the number is correctly composed.

³ <https://www.gs1.org/lim>

Figure 3.7.3-1. Format of the element string

GS1 Application Identifier	Global Shipment Identification Number (GSIN)																
	GS1 Company Prefix										Shipper reference						Check digit
4 0 2	N ₁	N ₂	N ₃	N ₄	N ₅	N ₆	N ₇	N ₈	N ₉	N ₁₀	N ₁₁	N ₁₂	N ₁₃	N ₁₄	N ₁₅	N ₁₆	N ₁₇

The data transmitted by the barcode reader means that the element string denoting a GSIN has been captured. When indicating this element string in the non-HRI text section of a barcode label, the following data title SHOULD be used (see also section 3.2): **GSIN**

3.7.4 Routing code: AI (403)

The GS1 Application Identifier (403) indicates that the GS1 Application Identifier data field contains a routing code. The routing code is assigned by the parcel carrier and is an attribute of the SSCC (Serial Shipping Container Code). It is intended to provide a migration path to the adoption of a yet-to-be-defined international, multi-modal solution. The routing code must not be used to encode information for which other element strings have been created (such as a ship to postal code).

The routing code field is alphanumeric and may include all characters contained in [Figure 7.11-1](#). Its content and structure are at the discretion of the parcel carrier issuing the code. If parcel carriers wish to enter co-operative agreements with other parcel carriers, then a mutually agreed indicator is required to designate the structure of the routing code.

Figure 3.7.4-1. Format of the element string

GS1 Application Identifier	Routing code
4 0 3	X ₁ ————— variable length —————> X ₃₀

The data transmitted from the barcode reader means that the element string denoting a routing code has been captured. As this element string is an attribute of a logistic unit, it must be processed together with the SSCC to which it relates. When indicating this element string in the non-HRI text section of a barcode label, the following data title SHOULD be used (see also section 3.2): **ROUTE**

3.7.5 Ship to - Deliver to Global Location Number: AI (410)

The GS1 Application Identifier (410) indicates that the GS1 Application Identifier data field contains the Global Location Number (GLN) of the consignee.

The GS1 Company Prefix is allocated by GS1 Member Organisations to the company that allocates the GLN – here the addressee (see section 1.4.4). It makes the number unique worldwide.

The structure and content of the location reference is at the discretion of the party who defined the location, in order to uniquely identify each location.

The check digit is explained in section 7.9. Its verification, which must be carried out in the application software, ensures that the number is correctly composed.

Figure 3.7.5-1. Format of the element string

GS1 Application Identifier	GS1 Company Prefix												Location reference	Check digit
4 1 0	N ₁	N ₂	N ₃	N ₄	N ₅	N ₆	N ₇	N ₈	N ₉	N ₁₀	N ₁₁	N ₁₂	N ₁₃	

The data transmitted from the barcode reader means that the element string denoting the GLN of the consignee of a physical item has been captured. This element string may be processed as stand-alone information where applicable or processed together with the GS1 identification number to which it relates. When indicating this element string in the non-HRI text section of a barcode label, the following data title SHOULD be used (see also section 3.2): **SHIP TO LOC**

3.7.6 Bill to - Invoice to Global Location Number: AI (411)

The GS1 Application Identifier (411) indicates that the GS1 Application Identifier data field contains the Global Location Number (GLN) of the addressee of an invoice.

The GS1 Company Prefix is allocated by GS1 Member Organisations to the company that allocates the GLN – here the addressee (see section 1.4.4). It makes the number unique worldwide.

The structure and content of the location reference is at the discretion of the party who defined the location, in order to uniquely identify each location.

The check digit is explained in section 7.9. Its verification, which must be carried out in the application software, ensures that the number is correctly composed.

Figure 3.7.6-1. Format of the element string

GS1 Application Identifier	GS1 Company Prefix	Location reference	Check digit
4 1 1	N ₁ N ₂ N ₃ N ₄ N ₅ N ₆ N ₇ N ₈ N ₉ N ₁₀ N ₁₁ N ₁₂		N ₁₃

The data transmitted from the barcode reader means that the element string denoting the GLN of the addressee of an invoice has been captured. This element string may be processed as stand-alone information where applicable or processed together with the GS1 identification number to which it relates. When indicating this element string in the non-HRI text section of a barcode label, the following data title SHOULD be used (see also section 3.2): **BILL TO**

3.7.7 Purchased from Global Location Number: AI (412)

The GS1 Application Identifier (412) indicates that the GS1 Application Identifier data field contains the Global Location Number (GLN) of the company from which the respective trade item has been purchased.

The GS1 Company Prefix is allocated by GS1 Member Organisations to the company that allocates the GLN – here the supplier (see section 1.4.4). It makes the number unique worldwide.

The structure and content of the location reference is at the discretion of the party who defined the location, in order to uniquely identify each location.

The check digit is explained in section 7.9. Its verification, which must be carried out in the application software, ensures that the number is correctly composed.

Figure 3.7.7-1. Format of the element string

GS1 Application Identifier	GS1 Company Prefix	Location reference	Check digit
4 1 2	N ₁ N ₂ N ₃ N ₄ N ₅ N ₆ N ₇ N ₈ N ₉ N ₁₀ N ₁₁ N ₁₂		N ₁₃

The data transmitted from the barcode reader means that the element string denoting the GLN of the company that supplied the trade item has been captured. This element string may be processed as stand-alone information where applicable or processed together with the GS1 identification number to which it relates.

When indicating this element string in the non-HRI text section of a barcode label the following data title SHOULD be used (see also section 3.2): **PURCHASE FROM**

3.7.8 Ship for - Deliver for - Forward to Global Location Number: AI (413)

The GS1 Application Identifier (413) indicates that the GS1 Application Identifier data field contains the Global Location Number (GLN) of the internal or subsequent final destination.

The GS1 Company Prefix is allocated by GS1 Member Organisations to the company that allocates the GLN – here the final recipient (see section 1.4.4). It makes the number unique worldwide.

The structure and content of the location reference is at the discretion of the party who defined the location, in order to uniquely identify each location.

The check digit is explained in section 7.9. Its verification, which must be carried out in the application software, ensures that the number is correctly composed.

 **Note:** This element string is for the internal use of the consignee and is not to be used by the carrier.

Figure 3.7.8-1. Format of the element string

GS1 Application Identifier	GS1 Company Prefix	Location reference	Check digit
4 1 3	N ₁ N ₂ N ₃ N ₄ N ₅ N ₆ N ₇ N ₈ N ₉ N ₁₀ N ₁₁ N ₁₂		N ₁₃

The data transmitted from the barcode reader means that the element string denoting the GLN of the final recipient of a physical item has been captured. This element string may be processed as stand-alone information where applicable or processed together with the GS1 identification number to which it relates. When indicating this element string in the non-HRI text section of a barcode label, the following data title SHOULD be used (see also section 3.2): **SHIP FOR LOC**

3.7.9 Identification of a physical location - Global Location Number: AI (414)

The GS1 Application Identifier (414) indicates that the GS1 Application Identifier data field contains the Global Location Number (GLN) of a physical location (see section 2.4).

The GS1 Company Prefix is allocated by GS1 Member Organisations to the company that allocates the GLN – here the holder of the physical location (see section 1.4.4). It makes the number unique worldwide.

The structure and content of the location reference is at the discretion of the party who defined the location, in order to uniquely identify each location.

The check digit is explained in section 7.9. Its verification, which must be carried out in the application software, ensures that the number is correctly composed.

Figure 3.7.9-1. Format of the element string

GS1 Application Identifier	GS1 Company Prefix	Location reference	Check digit
4 1 4	N ₁ N ₂ N ₃ N ₄ N ₅ N ₆ N ₇ N ₈ N ₉ N ₁₀ N ₁₁ N ₁₂		N ₁₃

The data transmitted from the barcode reader means that the element string denoting the GLN of a physical location has been captured from the location itself. This element string may be processed as stand-alone information where applicable or processed together with the GS1 identification number to which it relates. When indicating this element string in the non-HRI text section of a barcode label, the following data title SHOULD be used (see also section 3.2): **LOC NO.**

3.7.10 Global Location Number of the invoicing party: AI (415)

The GS1 Application Identifier (415) indicates that the GS1 Application Identifier data field contains the Global Location Number (GLN) of the invoicing party.

The GS1 Company Prefix is allocated by GS1 Member Organisations to the company that allocates the GLN – here the invoicing party (see section 1.4.4). It makes the number unique worldwide.

The structure and content of the location reference is at the discretion of the party who defined the location, in order to uniquely identify each location.

The check digit is explained in section 7.9. Its verification, which must be carried out in the application software, ensures that the number is correctly composed.

 **Note:** This element string is mandatory on a payment slip. Together with the payment slip reference number, AI (8020), it uniquely identifies a payment slip.

Figure 3.7.10-1. Format of the element string

GS1 Application Identifier	GS1 Company Prefix	Location reference	Check digit
4 1 5	N ₁ N ₂ N ₃ N ₄ N ₅ N ₆ N ₇ N ₈ N ₉ N ₁₀ N ₁₁ N ₁₂		N ₁₃

The data transmitted from the barcode reader means that the element string denoting the GLN of the invoicing party has been captured. This element string must be processed together with the payment slip reference number, AI (8020), to which it relates. When indicating this element string in the non-HRI text section of a barcode label, the following data title SHOULD be used (see also section 3.2): **PAY TO**

3.7.11 GLN of the production or service location: AI (416)

The Application Identifier (416) indicates that the GS1 Application Identifier data field contains the Global Location Number (GLN) of the production or service location.

The GS1 Company Prefix is allocated by GS1 Member Organisations to the company that allocates the GLN (see section 1.4.4).

The structure and content of the location reference is at the discretion of the party that defined the location.

The check digit is explained in section 7.9. Its verification, which must be carried out in the application software, ensures that the number is correctly composed.

Figure 3.7.11-1. Format of the element string

GS1 Application Identifier	GS1 Company Prefix	Location reference	Check digit
4 1 6	N ₁ N ₂ N ₃ N ₄ N ₅ N ₆ N ₇ N ₈ N ₉ N ₁₀ N ₁₁ N ₁₂		N ₁₃

The data transmitted from the barcode reader means that the element string denoting the GLN of production or service location has been captured. This element string SHALL be processed together with the GS1 identification key to which it relates. When indicating this element string in the non-HRI text section of a barcode label, the following data title SHOULD be used (see also section 3.2): **PROD/SERV LOC**

3.7.12 Ship to - Deliver to postal code within a single postal authority: AI (420)

The GS1 Application Identifier (420) indicates that the GS1 Application Identifier data field contains the postal code of the addressee (national format). The postal code field contains the postal code of the addressee as defined by the appropriate postal authority. It is left justified and must not contain any fill characters.

Figure 3.7.12-1. Format of the element string

GS1 Application Identifier	Postal code
4 2 0	X ₁ ——variable length——>X ₂₀

The data transmitted from the barcode reader means that the element string denoting the national version of a postal code of the addressee of the transport unit has been captured. This element string is normally processed as stand-alone information. When indicating this element string in the non-HRI text section of a barcode label, the following data title SHOULD be used (see also section 3.2): **SHIP TO POST**

3.7.13 Ship to - Deliver to postal code with three-digit ISO country code: AI (421)

The GS1 Application Identifier (421) indicates that the GS1 Application Identifier data field contains the postal code of the addressee (international format). The ISO country code field contains the three-digit country number of the numerical international standard *ISO 3166*.

The national postal code field, which follows the three-digit ISO country code, contains the postal code of the addressee as defined by the appropriate postal authority. It is left justified and must not contain any fill characters.

Figure 3.7.13-1. Format of the element string

GS1 Application Identifier	ISO country code	Postal code
4 2 1	N ₁ N ₂ N ₃	X ₄ —variable length—X ₁₂

The data transmitted from the barcode reader means that the element string denoting the international version of a postal code of the addressee of the transport unit has been captured. This element string is normally processed as stand-alone information.

When indicating this element string in the non-HRI text section of a barcode label, the following data title SHOULD be used (see also section [3.2](#)): **SHIP TO POST**

3.7.14 Country of origin of a trade item: AI (422)

The GS1 Application Identifier (422) indicates that the GS1 Application Identifier data field contains the ISO country code of the country of origin of the trade item. The ISO country code field contains the three-digit country number of the numerical international standard *ISO 3166* that is the country of origin.

- 
Note: The country of origin is normally the country in which the trade item has been produced or manufactured. In meat supply chain applications AI (422) is used to indicate the country of birth of the animal. Due to a wide range of definitions for country of origin, which were created for different purposes, it is the manufacturer's responsibility to assign the correct country of origin.

Figure 3.7.14-1. Format of the element string

GS1 Application Identifier	ISO country code
4 2 2	N ₁ N ₂ N ₃

The data transmitted from the barcode reader means that the element string denoting the ISO country code of the country of origin of the respective trade item has been captured. As this element string is an attribute of a trade item, it must be processed together with the GTIN of the trade item to which it relates.

When indicating this element string in the non-HRI text section of a barcode label, the following data title SHOULD be used (see also section [3.2](#)): **ORIGIN**

3.7.15 Country of initial processing: AI (423)

The GS1 Application Identifier (423) indicates that the GS1 Application Identifier data field contains the ISO country code(s) of the country or countries of initial processing of the trade item.

The ISO country code field contains the three-digit country code(s) from the numerical international standard *ISO 3166* that indicates the country or countries of initial processing.

- 
Note: The country of initial processing is normally the country in which the trade item has been produced or manufactured. In meat supply chain applications AI (423) is used to indicate the country / countries of rearing and fattening of the animal. In certain applications, such as livestock fattening, the country of initial processing may include up to five different countries, all of which should be indicated. It is the responsibility of the supplier to allocate the correct country code(s).

Figure 3.7.15-1. Format of the element string

GS1 Application Identifier	ISO country code(s)
4 2 3	N ₁ N ₂ N ₃ ... N ₁₅

The data transmitted from the barcode reader means that the element string denoting the ISO country code(s) of the country or countries of initial processing of the respective trade item has been captured. As this element string is an attribute of a trade item, it must be processed together with the GTIN of the trade item to which it relates.

When indicating this element string in the non-HRI text section of a barcode label, the following data title SHOULD be used (see also section 3.2): **COUNTRY – INITIAL PROCESS**

3.7.16 Country of processing: AI (424)

The GS1 Application Identifier (424) indicates that the GS1 Application Identifier data field contains the ISO country code of the country of processing of the trade item.

The ISO country code field contains the three-digit country code of the numerical international standard *ISO 3166* that is the country of processing.

- 
Note: It is the responsibility of the processor of the trade item to allocate the correct country code. In meat or fish supply chain applications AI (424) is used to indicate the country of slaughtering or processing.

Figure 3.7.16-1. Format of the element string

GS1 Application Identifier	ISO country code
4 2 4	N ₁ N ₂ N ₃

The data transmitted from the barcode reader means that the element string denoting the ISO country code of the country of processing of the respective trade item has been captured. As this element string is an attribute of a trade item, it must be processed together with the GTIN of the trade item to which it relates.

When indicating this element string in the non-HRI text section of a barcode label, the following data title SHOULD be used (see also section 3.2): **COUNTRY – PROCESS**

3.7.17 Country of disassembly: AI (425)

The GS1 Application Identifier (425) indicates that the GS1 Application Identifier data field contains the ISO country code of the country or countries of disassembly of the trade item. The ISO country code field contains the three-digit country code(s) from the numerical international standard *ISO 3166* that indicates the country or countries of disassembly.

- 
Note: In meat supply chain applications AI (425) is used to indicate the country of deboning. In certain applications, such as meat or fish process chains, the process of disassembly is a multi-stage process and the country of disassembly may include several different countries, all of which should be indicated. It is the responsibility of the party doing the disassembly of the trade item to allocate the correct country code(s).

Figure 3.7.17-1. Format of the element string

GS1 Application Identifier	ISO country code
4 2 5	N ₁ N ₂ N ₃ ...N ₁₅

The data transmitted from the barcode reader means that the element string denoting the ISO country code(s) of the country or countries of disassembly of the respective trade item has been captured. As this element string is an attribute of a trade item, it must be processed together with

the GTIN of the trade item to which it relates. When indicating this element string in the non-HRI text section of a barcode label, the following data title SHOULD be used (see also section 3.2): **COUNTRY – DISASSEMBLY**

3.7.18 Country covering full process chain: AI (426)

The GS1 Application Identifier (426) indicates that the GS1 Application Identifier data field contains the ISO country code of the country where all the processing of the trade item took place. The ISO country code field contains the three-digit country code of the numerical international standard *ISO 3166* that is the country of full processing.

- 
Note: If this AI is used, the full processing of a trade item must have taken place in a single country. This is particularly important in certain applications (e.g., covering a livestock animal’s birth, fattening, and slaughter) where processing could take place in different countries. In situations like this, AI (426) may not be used. It is the responsibility of the supplier to allocate the correct country code.

Figure 3.7.18-1. Format of the element string

GS1 Application Identifier	ISO country code		
4 2 6	N ₁	N ₂	N ₃

The data transmitted from the barcode reader means that the element string denoting the ISO country code of the country of full processing of the trade item has been captured. As this element string is an attribute of a trade item, it must be processed together with the GTIN of the trade item to which it relates.

When indicating this element string in the non-HRI text section of a barcode label, the following data title SHOULD be used (see also section 3.2): **COUNTRY – FULL PROCESS**

3.7.19 Country subdivision of origin code for a trade item: AI (427)

The GS1 Application Identifier (427) indicates that the GS1 Application Identifier data field contains the ISO based country subdivision code (e.g. provinces, states, cantons, etc.) of a country’s local region origin of the trade item. The ISO country subdivision code field contains up to three alphanumeric characters after separator of *ISO 3166-2* that is the principal subdivision of origin.



- 
Note: This GS1 AI is applicable to trade item groupings where the contents originate from only one region.
- 
Note: The local region of origin is the principal subdivision in which the trade item has been produced or manufactured. Determination of the principle subdivision is the brand owner’s responsibility.

Figure 3.7.19-1. Format of the element string

GS1 Application Identifier	ISO subdivision code
4 2 7	X ₁ ——variable length——> X ₃

The data transmitted from the barcode reader means that the element string denoting the ISO based country subdivision code of the trade item has been captured. This element string must be processed together with the GTIN of the trade item and the country of origin, AI (422), to which it relates. When indicating this element string in the non-HRI text section of a barcode label, the following data title SHOULD be used (see also section 3.2): **ORIGIN SUBDIVISION**

3.8 GS1 Application Identifiers starting with digit 7

3.8.1 Seven series AIs - Cautionary note

GS1 Application Identifiers issued in the 7 series represent a special case because they are restricted to:

- one or a small number of sectors (i.e. are not multi-sectoral) or
- a country or a region (i.e. are not global).

3.8.2 NATO Stock Number (NSN): AI (7001)

The GS1 Application Identifier (7001) indicates that the GS1 Application Identifier data field contains a NATO stock number.

The NATO stock number is the number allocated to any item of supply in the NATO Alliance. It is the responsibility of the country that manufactures or controls the design of the item to allocate the number.

 **Note:** This element string is only for use within the context of the supply within the NATO Alliance. Use of it is subject to the rules and regulations of the Allied Committee 135 (AC/135), the NATO Group of National Directors on Codification.

Figure 3.8.2-1. Format of the element string

GS1 Application Identifier	NATO supply classification	Assigning country	Sequential number
7 0 0 1	N ₁ N ₂ N ₃ N ₄	N ₅ N ₆	N ₇ N ₈ N ₉ N ₁₀ N ₁₁ N ₁₂ N ₁₃

The data transmitted from the barcode reader means that the element string denoting a NATO stock number has been captured. As this element string is an attribute of a trade item, it must be processed together with the GTIN of the trade item to which it relates. When indicating this element string in the non-HRI text section of a barcode label, the following data title SHOULD be used (see also section 3.2): **NSN**

3.8.3 UN/ECE meat carcasses and cuts classification: AI (7002)

The GS1 Application Identifier (7002) indicates that the GS1 Application Identifier data field contains a UN/ECE meat carcasses and cuts classification code.

The UN/ECE meat carcasses and cuts code is an attribute of a Global Trade Item Number (GTIN) that denotes the trade description of the product. It is an alphanumeric, variable length code up to 30 characters.

 **Note:** This element string is only for use within the context of UN/ECE standards for the quality of meat carcasses and cuts (bovine, porcine, ovine, and caprine).

Figure 3.8.3-1. Format of the element string

GS1 Application Identifier	UN/ECE product classification
7 0 0 2	X ₁ —————variable length—————>X ₃₀

The data transmitted from the barcode reader means that the element string denoting a UN/ECE meat carcasses and cuts code has been captured. As this element string is an attribute of a trade item, it must be processed together with the GTIN of the trade item to which it relates. When indicating this element string in the non-HRI text section of a barcode label, the following data title SHOULD be used (see also section 3.2): **MEAT CUT**

3.8.4 Expiration date and time: AI (7003)

The GS1 Application Identifier (7003) indicates that the data fields contain expiration date and time.

The manufacturer determines the expiration date and time, which is relevant only for short duration and for items that will not be sent on long distances and not outside of the time zone. A typical application of AI (7003) is in hospitals or public pharmacies for special, customised, products which may have a "life duration" shorter than one single day. The life duration varies according the pharmaceutical substances used in the treatment. The precise expiration date and time is defined at the end of the manufacturing process, and can be barcoded on the product label as an attribute to the item's GTIN. Where there is no business requirement to express the expiration date to the nearest hour (or less), AI (17) Expiration date should be used.

The structure is:

- **Year:** the tens and units of the year (e.g., 2007 = 07), which is mandatory.
- **Month:** the number of the month (e.g., January = 01), which is mandatory.
- **Day:** the number of the day of the relevant month (e.g., second day = 02), which is mandatory.
- **Hour:** the number of the hour based on local 24-hour time (e.g., 2 p.m. = 14), which is mandatory.
- **Minutes:** the number of the minutes based on local time (e.g., 15 minutes. = 15); if it is not necessary to specify the minutes, the field must be filled with two zeros. Time will then be interpreted as ending on the hour (e.g., 14:00 = expiry time at 14:00).

Figure 3.8.4-1. Format of the element string

GS1 Application Identifier	Expiration date and time				
	YY	MM	DD	HH	MM
7 0 0 3	N ₁ N ₂	N ₃ N ₄	N ₅ N ₆	N ₇ N ₈	N ₉ N ₁₀

The data transmitted from the barcode reader means that the element string denoting an expiration date and time has been captured. As this element string is an attribute of a trade item, it must be processed together with the GTIN of the trade item to which it relates. When indicating this element string in the non-HRI text section of a barcode label, the following data title SHOULD be used (see also section 3.2): **EXPIRY TIME**

- ✓ **Note:** element string can only specify dates in the range from 49 years in the past to 50 years in the future. Determination of the correct century is explained in section 7.12.

3.8.5 Active potency: AI (7004)

The GS1 Application Identifier (7004) indicates that the GS1 Application Identifier data field contains an active potency.

The active potency of certain healthcare products (e.g. certain biologics, such as haemophilia products) varies by batch, and this will vary, within agreed tolerances, from the nominal potency of the trade item. Both the nominal and active potency of the item are measured in International Units (IUs).

Figure 3.8.5-1. Format of the element string

GS1 Application Identifier	Active potency
7 0 0 4	N ₁ —variable length—→ N ₄

The data transmitted from the barcode reader means that the Active potency of a Trade Item has been captured. The Active potency must be processed with the GTIN and batch or lot number of the trade item to which it relates. When indicating this element string in the non-HRI text section of a barcode label, the following data title SHOULD be used (see also section 3.2): **ACTIVE POTENCY**.

3.8.6 Catch area: AI (7005)

The GS1 Application Identifier (7005) indicates that the GS1 Application Identifier data field contains the Catch Area. The Catch Area identifies where the fisheries product was caught using the international fishing areas and subareas as defined by the United Nations Fisheries and Aquaculture Department of the Food and Agricultural Organization (FAO). A complete FAO Catch Area list can be accessed via: <http://www.fao.org/fishery/area/search/en>. It is assigned by the fishing vessel that has caught the fisheries product. These major fishing areas comprise:

- Major inland fishing areas covering the inland waters of the continents,
- Major marine fishing areas covering the waters of the Atlantic, Indian, Pacific, and Southern Oceans, with their adjacent seas.

 **Note:** The major fishing areas, inland and marine, as well as the subareas can be identified when using this GS1 Application Identifier; FAO example: 27.8.e.2 West of Bay of Biscay Non-NEAFC Regulatory Area

Figure 3.8.6-1. Format of the element string

GS1 Application Identifier	Catch area
7 0 0 5	X ₁ ———>variable length ———>X ₁₂

The data transmitted from the barcode reader means that the element string denoting the Catch Area that has been captured. As this element string is an attribute of a trade item, it must be processed together with the GTIN of the trade item to which it relates.

When indicating this element string in the non-HRI text section of a barcode label, the following data title SHOULD be used (see also section 3.2): **CATCH AREA**

3.8.7 First freeze date: AI (7006)

The GS1 Application Identifier (7006) indicates that the GS1 Application Identifier data field contains a first freeze date. The first freeze date is applicable to products that are frozen directly after slaughtering, harvesting, catching or after initial processing of the product. Examples include fresh meat, meat products or fishery products. The first freeze date is determined by the organisation conducting the freezing.

The structure is:

- Year: the tens and units of the year (e.g., 2003 = 03), which is mandatory.
- Month: the number of the month (e.g., January = 01), which is mandatory.
- Day: the number of the day of the relevant month (e.g., second day = 02); this field must always be filled.

 **Note:** This element string can only specify dates ranging from 49 years in the past to 50 years in the future. Determination of the correct century is explained in section 7.12.

Figure 3.8.7-1. Format of the element string

GS1 Application Identifier	First freeze date		
	Year	Month	Day
7 0 0 6	N ₁ N ₂	N ₃ N ₄	N ₅ N ₆

The data transmitted from the barcode reader means that the element string denoting a first freeze date has been captured. As this element string is an attribute of a trade item, it must be processed together with the trade item GTIN to which it relates.

When indicating this element string in the non-HRI text section of a barcode label, the following data title SHOULD be used (see also section 3.2): **FIRST FREEZE DATE**

3.8.8 Harvest date: AI (7007)

The GS1 Application Identifier (7007) indicates that the GS1 Application Identifier data field contains a harvest date or date range. For example, the harvest date can be the date or date range when an animal was slaughtered or killed, a fish has been harvested, or a crop was harvested. This date or date range is determined by the organisation conducting the harvesting. Different organisations may use more specific terminology when referring to their specific needs and use terms such as: Date of catch or slaughter date. When referring to animals the date range refers to the whole animal and all meat or fish cuts derived from this animal.

The structure includes two distinct segments:

- Start date: This specifies the start of the time period being identified:
 - Year: the tens and units of the year (e.g., 2003 = 03), which is mandatory.
 - Month: the number of the month (e.g., January = 01), which is mandatory.
 - Day: the number of the day of the relevant month (e.g., second day = 02); for a harvest date. This field must always be filled.
- End date: This specifies the end of the time period being identified:
 - Year: the tens and units of the year (e.g., 2003 = 03).
 - Month: the number of the month (e.g., January = 01).
 - Day: the number of the day of the relevant month (e.g., second day = 02); for a harvest date.

✔ **Note:** This element string can only specify dates ranging from 49 years in the past to 50 years in the future. Determination of the correct century is explained in section [7.12](#).

✔ **Note:** In case the catch period spans one calendar day, the end date SHALL NOT be specified. In case the catch period spans multiple calendar days, both the start and end date must be specified, with the end date being greater than the start date.

Figure 3.8.8-1. Format of the element string

GS1 Application Identifier	Harvest start date			Harvest end date		
	Year	Month	Day	Year	Month	Day
7 0 0 7	N ₁ N ₂	N ₃ N ₄	N ₅ N ₆	N ₇ N ₈	N ₉ N ₁₀	N ₁₁ N ₁₂

The data transmitted from the barcode reader means that the element string denoting a harvest date range has been captured. As this element string is an attribute of a trade item, it must be processed together with the GTIN of the trade item to which it relates.

When indicating this element string in the non-HRI text section of a barcode label, the following data title SHOULD be used (see also section [3.2](#)): **HARVEST DATE**

3.8.9 Species for fishery purposes: AI (7008)

The GS1 Application Identifier (7008) indicates that the GS1 Application Identifier data field contains the fish species according to the 3-alpha Aquatic Sciences and Fisheries Information System (ASFIS) list of species.

The United Nations Fisheries and Aquaculture Department of the Food and Agricultural Organization (FAO) Fisheries and Aquaculture Statistics and Information Service (FIPS) collates world capture and aquaculture production statistics at the species, genus, family or higher taxonomic levels in 2,119 statistical categories (2011 data) referred to as species items. ASFIS list of species includes 12,421 species items selected according to their interest or relation to fisheries and aquaculture. For each species item stored in a record, codes (International Standard Statistical Classification of Aquatic Animals and Plants group, taxonomic and 3-alpha) and taxonomic information (scientific name, author(s), family, and higher taxonomic classification) are provided. An English name is available for most of the records, and about one third of them have also a French and Spanish name. Information is also provided about the availability of fishery production statistics on the species item in the FAO

databases; example: IZX. This list can be accessed via:
<http://www.fao.org/fishery/collection/asfis/en>

Figure 3.8.9-1. Format of the element string

GS1 Application Identifier	Species for fishery purposes code
7 0 0 8	X ₁ —variable length—> X ₃

The data transmitted from the barcode reader means that the element string denoting the species for fishery purposes that has been captured. As this element string is an attribute of a trade item, it must be processed together with the GTIN of the trade item to which it relates.

When indicating this element string in the non-HRI text section of a barcode label, the following data title SHOULD be used (see also section 3.2): **AQUATIC SPECIES**

3.8.10 Fishing gear type: AI (7009)

The GS1 Application Identifier (7009) indicates that the GS1 Application Identifier data field contains the information on the fishing gear type.

It is assigned by the fishing vessel that has caught the fisheries product. The fishing gear type, as defined by the United Nations Fisheries and Aquaculture Department of the Food and Agricultural Organization (FAO), is used to identify the type of fishing gear used for catching the fisheries product. The fishing gear type list provides definitions of fishing gear of all kinds, grouped by categories. These definitions and classifications are valid on a world-wide basis for both inland waters and sea fisheries, as well as, for small-, medium-, and large-scale fisheries; example: 01.1.1 (one boat operated purse seines). This list can be accessed via:
<http://www.fao.org/fishery/cwp/handbook/M/en>.

Figure 3.8.10-1. Format of the element string

GS1 Application Identifier	Fishing gear type
7 0 0 9	X ₁ —variable length—> X ₁₀

The data transmitted from the barcode reader means that the element string denoting the fishing gear type that has been captured. This element string is an attribute of a trade item, it must be processed together with the GTIN of the trade item to which it relates.

When indicating this element string in the non-HRI text section of a barcode label, the following data title SHOULD be used (see also section 3.2): **FISHING GEAR TYPE**

3.8.11 Production method: AI (7010)

The GS1 Application Identifier (7010) indicates that the GS1 Application Identifier data field describes the production method.

It is assigned by the fishing vessel that has caught the fisheries product. The **production method** provides the production method for fish and seafood as specified by the Fisheries and Aquaculture Department of the Food and Agricultural Organization (FAO) of the United Nations; example: 01.

The allowed values, as defined by the Fisheries and Aquaculture Department of the Food and Agricultural Organization (FAO) of the United Nations are:

- 01 'Caught at Sea'.
- 02 'Caught in Fresh Water'.
- 03 'Farmed'.
- 04 'Cultivated'.

Figure 3.8.11-1. Format of the element string

GS1 Application Identifier	Production method
7 0 1 0	X ₁ —variable length—→X ₂

The data transmitted from the barcode reader means that the element string denoting the production method has been captured. As this element string is an attribute of a trade item, it must be processed together with the GTIN of the trade item to which it relates.

When indicating this element string in the non-HRI text section of a barcode label, the following data title SHOULD be used (see also section 3.2): **PROD METHOD**

3.8.12 Refurbishment lot ID: AI (7020)

GS1 Application Identifier (7020) indicates that the GS1 Application Identifier data field contains a refurbishment lot ID.

Together with the GTIN of the trade item and the GLN of the production or service location, the refurbishment lot ID identifies a batch of items that were remanufactured to the original specifications using a combination of reused, repaired and new parts. It is an alphanumeric, variable length string of up to 20 characters.

Figure 3.8.12-1. Format of the element string

GS1 Application Identifier	Refurbishment lot ID
7 0 2 0	X ₁ —————variable length—————→X ₂₀

The data transmitted from the barcode reader means that the element string denoting a refurbishment lot ID has been captured. It must be processed together with the GLN of the production / service location and the GTIN of the item to which it is related. When indicating this element string in the non-HRI text section of a barcode label, the following data title SHOULD be used (see also section 3.2): **REFURB LOT**

3.8.13 Functional status: AI (7021)

GS1 Application Identifier (7021) indicates that the GS1 Application Identifier data field contains the functional status.

The functional status of the trade item may need to be included by the manufacturer to meet regulatory or commercial requirements. For example requirements related to the type approval, allowing the trade item to be sold in a particular country.

Figure 3.8.13-1. Format of the element string

GS1 Application Identifier	Functional status
7 0 2 1	X ₁ —————variable length—————→X ₂₀

The data transmitted from the barcode reader means that the element string denoting a functional status has been captured. As this element string is an attribute of a trade item, it must be processed in combination with the GTIN of the item to which it is related. When indicating this element string in the non-HRI text section of a barcode label, the following data title SHOULD be used (see also section 3.2): **FUNC STAT**

3.8.14 Revision status: AI (7022)

GS1 Application Identifier (7022) indicates that the GS1 Application Identifier data field contains the revision status.

The revision status of the trade item may need to be included by the manufacturer to meet regulatory or commercial requirements. For example, requirements related to the type approval, allowing the trade item to be sold in a particular country.

Figure 3.8.14-1. Format of the element string

GS1 Application Identifier	Revision status
7 0 2 2	X_1 ————— variable length ————— X_{20}

The data transmitted from the barcode reader means that the element string denoting a revision status has been captured. As this element string is subordinate to the functional status, it must be processed in combination with the functional status and the GTIN of the item to which it is related. When indicating this element string in the non-HRI text section of a barcode label, the following data title SHOULD be used (see also section 3.2): **REV STAT**

3.8.15 Global Individual Asset Identifier of an assembly: AI (7023)

GS1 Application Identifier (7023) indicates that the GS1 Application Identifier data field contains the GIAI (Global Individual Asset Identifier) of an assembly.

An additional barcode containing the GIAI of an assembly may need to be marked on a sub-component of the assembly (the so called leading part) in case the assembly does not have a surface that uniquely belongs to the assembly (and not to any of its sub-components). In order to distinguish between the identifier of the sub-component and the identifier of the assembly a separate GS1 application identifier is used for the latter.

The GS1 Company Prefix (see section 1.4.4) is allocated by GS1 Member Organisations to the company that allocates the GIAI –the asset owner or manager of the individual asset.

The structure and content of the individual asset reference is at the discretion of the asset owner or manager. It may contain all characters listed in figure 7.11-1.

Figure 3.8.15-1. Format of the element string

GS1 Application Identifier	Global Individual Asset Identifier (GIAI) of an assembly			
	GS1 Company Prefix		Individual asset reference	
7 0 2 3	N_1 ...	N_i	X_{i+1} ...	variable length $X_j (j \leq 30)$

The data transmitted from the barcode reader means that the element string denoting a parent GIAI has been captured. When indicating this element string in the non-HRI text section of a barcode label, the following data title SHOULD be used (see also section 3.2): **GIAI - ASSEMBLY**

3.8.16 Number of processor with three-digit ISO country code: AI (703s)

The GS1 Application Identifier (703s) indicates that the GS1 Application Identifier data fields contain the ISO country code and approval number or GLN of the processor of a trade item. The number of processor is an attribute to a Global Trade Item Number (GTIN). It designates the number of the company who did the processing.

As many processors may be involved, each with an individual approval number, the fourth digit of the AI (s in the figure below) indicates the sequence of the processors.

For a typical meat supply chain, the following sequence would be used:

- 7030: slaughterhouse.
- 7031: first deboning/cutting hall.
- 7032 to 7037: second through seventh processing location (cutting hall).
- 7038: slaughterhouse.
- 7039: slaughterhouse.

For a typical seafood supply chain, the following sequence would be used:

- 7030 vessel / aquaculture site.
- 7031 primary processor.

- 7032 secondary processor.

The ISO country code contains the three-digit country number of the numerical international standard *ISO 3166* that relates to the following approval number of processor.

If '999' is entered as the ISO country code it signifies that the subsequent data is a Global Location Number (GLN), and not an 'approval number'.

Note: The approval number is usually assigned by a national or pluri-national authority to processors in the food supply chain. These authorities may choose to use the Global Location Number (GLN) (see section 2.4) for this purpose. The approval number (or GLN) remains with the item regardless of whether or not it changes ownership or function.

Figure 3.8.16-1. Format of the element string

GS1 Application Identifier	ISO country code	Number of processor
7 0 3 s	N ₁ N ₂ N ₃	X ₄ —variable length—> X ₃₀

The data transmitted from the barcode reader means that the element string denoting the ISO country code and number of processor has been captured. As this element string is an attribute of a trade item, it must be processed together with the GTIN of the trade item to which it relates.

When indicating this element string in the non-HRI text section of a barcode label, the following data title SHOULD be used (see also section 3.2): **PROCESSOR # s**

3.8.17 National Healthcare Reimbursement Number (NHRN): AIs (710), (711), (712), and (713)

The GS1 Application Identifiers (710), (711), (712), and (713) indicate that the GS1 Application Identifier data field contains a National Healthcare Reimbursement Number, from the NHRN GS1 Application Identifier series, associated to the Global Trade Item Number (GTIN) of the trade item. The GS1 Application Identifiers (710), (711), (712), and (713) indicate a specific NHRN from within the assigned series.

Use of the NHRN GS1 Application Identifier, associated to the GTIN of the trade item, is needed for compliance with a national/regional regulatory or industry requirement where the GTIN will not meet the need.







GTIN is the GS1 identifier for pharmaceutical and medical device trade items. The GS1 Application Identifier for National Healthcare Reimbursement Number is provided to meet regulatory or industry requirements until they are amended to accept the GTIN as a compliant identifier.

Within this application are the rules and recommendations for the association of NHRNs to the Global Trade Item Number (GTIN) where regulatory requirements require an NHRN for product identification, registration or reimbursement purposes.

There are a number of known NHRNs but at this time not all are required to be encoded within the data carrier found on the trade item. Flexibility for additional assigned NHRN AIs has been provided if required.

The National Healthcare Reimbursement Number GS1 Application Identifier is an initial step in a migration path to the most efficient method to identify trade items. GS1 recommends that Healthcare stakeholders faced with national numbers:

- Use GTIN for all supply chain and reimbursement purposes (GTIN used in the data carrier and as the NHRN) as this is the most efficient and effective way for all stakeholders to identify trade items.
- Use GTIN, cross-referenced to an NHRN in an existing database, in the case of an existing system of NHRNs (i.e. GTIN used in the data carrier with the NHRN found via cross-reference).
- Use GTIN with an associated NHRN (GTIN and NHRN both used in the data carrier via the NHRN AI) as an intermediate solution for those who cannot use "a" or "b". GS1 only recommends this as a migration path to noted options "a" or "b".

- 
Note: There is a mandatory association of the National Healthcare Reimbursement Number Application Identifier with the GTIN.
- 
Note: The NHRN is usually assigned by a national authority to healthcare brand owners for specific trade items and SHALL only be used for compliance to regulatory requirements where the GTIN alone will not meet the requirements.
- 
Note: Additional individual NHRN AIs can only be assigned by GS1 and only in response to a work request being submitted into the GSMP system.
- 
Note: The GTIN and all associated NHRNs SHOULD be concatenated into a single data carrier (i.e. single GS1-128, GS1 DataMatrix).
- 
Note: Use of NHRN on the item is controlled by and subject to the rules and regulations of national/regional agencies. Those rules and/or regulations may supersede these recommendations.
- 
Note: More than one NHRN may need to be associated with a given GTIN.

The general format of an NHRN GS1 Application Identifier is:

Figure 3.8.17-1. Format of the element string

GS1 Application Identifier	National Healthcare Reimbursement Number
n n n	X ₁ ——variable length——>X ₂₀

- 
Note: When an NHRN AI is approved, the overall variable length (i.e. allowable number of characters) is specified by the national authority, with a twenty (20) character maximum as noted in the general format above if applicable.

The GS1 Application Identifiers used with this element string, their specific format and associated regulatory body or assigning organisation, are shown in the figure below:

Figure 3.8.17-2. Overview of NHRN Application Identifiers

GS1 Application Identifier	National Healthcare Reimbursement Number	Organisation
710	X ₁ variable length X ₂₀	Germany IFA
711	X ₁ variable length X ₂₀	France CIP
712	X ₁ variable length X ₂₀	Spain National Code
713	X ₁ variable length X ₂₀	Brazil ANVISA
nnn (*)	X ₁ variable length X ₂₀	Country "A" NHRN Authority
(*) An example to illustrate future additional NHRNs. If additional NHRN AIs are required, a request for a new NHRN AI SHALL be made through the GS1 GSMP.		

- 
Note: Companies wishing to apply one of the listed NHRN AIs will need to associate that NHRN AI to the trade item's GTIN according to the NHRN AI rules and should contact their GS1 Member Organisation for further considerations of use.

The data transmitted from the barcode reader means that the element string denoting a National Healthcare Reimbursement Number has been captured. This element string is an attribute of a trade item and must be processed together with the GTIN of the trade item to which it relates. When indicating this element string in the non-HRI text section of a barcode label, the data title in figure 3.2-1 SHOULD be used.

3.9 GS1 Application Identifiers starting with digit 8

3.9.1 Roll products - width, length, core diameter, direction, splices: AI (8001)

The GS1 Application Identifier (8001) indicates that the GS1 Application Identifier data fields contain the variable attributes of a roll product. Depending on the method of production, some roll products cannot be numbered according to standard criteria that have been determined in advance. They are, therefore, classified as variable items. For those products where the standard trade measures are not sufficient, the following guidelines should be used.

The identification of a roll product consists of the Global Trade Item Number (GTIN) and the variable attributes. The basic product (e.g., a certain type of paper) is included as data in the GTIN-14 ID number (see section 2.1.6), and the variables contain information about the special features of the particular item that has been produced. The variable values of a roll product, N1 to N14, consist of the following data:

- N1 to N4: slit width in millimetres (width of the roll).
- N5 to N9: actual length in metres.
- N10 to N12: internal core diameter in millimetres.
- N13: winding direction (face out 0, face in 1, undefined 9).
- N14: number of splices (0 to 8 = actual number, 9 = number unknown).

Figure 3.9.1-1. Format of the element string

GS1 Application Identifier	Variable values of a roll product													
8 0 0 1	N ₁	N ₂	N ₃	N ₄	N ₅	N ₆	N ₇	N ₈	N ₉	N ₁₀	N ₁₁	N ₁₂	N ₁₃	N ₁₄

The data transmitted from the barcode reader means that the element string denoting the variable attributes of the identification of a roll product trade item have been captured. This element string must be processed together with the GTIN of the trade item to which it relates (see section 3.3.2). When indicating this element string in the non-HRI text section of a barcode label, the following data title SHOULD be used (see also section 3.2): **DIMENSIONS**

3.9.2 Cellular mobile telephone identifier: AI (8002)

The GS1 Application Identifier (8002) indicates that the GS1 Application Identifier data field contains the serial number of a cellular mobile telephone.

The serial number field is alphanumeric and may contain all characters contained in [Figure 7.11-1](#). A national or pluri-national authority usually assigns the number. It uniquely identifies each mobile telephone within a given authority for special control purposes. It is not considered as an attribute of the identification of the telephone as a trade item.

Figure 3.9.2-1. Format of the element string

GS1 Application Identifier	Serial number
8 0 0 2	X ₁ ———variable length ———> X ₂₀

The data transmitted from the barcode reader means that the element string denoting an electronic serial identifier of a cellular mobile telephone has been captured. This element string is normally processed as stand-alone information.

When indicating this element string in the non-HRI text section of a barcode label, the following data title SHOULD be used (see also section 3.2): **CMT NO.**

3.9.3 Global Returnable Asset Identifier (GRAI): AI (8003)

The GS1 Application Identifier (8003) indicates that the GS1 Application Identifier data field contains the GRAI (Global Returnable Asset Identifier). The GRAI is used to identify returnable assets.

The GS1 Company Prefix (see section 1.4.4) is allocated by GS1 Member Organisations to the company that allocates the GRAI – the asset owner or manager of the returnable asset. It makes the number unique worldwide.

A zero in the leftmost position is added to generate an even number of 14 digits which enables efficient encoding.

The structure and content of the asset type is at the discretion of the asset owner or manager.

The check digit is explained in section 7.9. Its verification, which must be carried out in the application software, ensures that the number is correctly composed.

The optional serial component is assigned by the asset owner or manager. It identifies an individual asset within a given asset type. The field is alphanumeric and may contain all characters listed in Figure 7.11-1.

Figure 3.9.3-1. Format of the element string

GS1 Application Identifier	Global Returnable Asset Identifier (GRAI)																
	GS1 Company Prefix						Asset type						Check digit	Serial component (optional)			
8 0 0 3	0	N ₁	N ₂	N ₃	N ₄	N ₅	N ₆	N ₇	N ₈	N ₉	N ₁₀	N ₁₁	N ₁₂	N ₁₃	X ₁	variable	X ₁₆

The data transmitted from the barcode reader means that the element string denoting the GRAI has been captured. When indicating this element string in the non-HRI text section of a barcode label, the following data title SHOULD be used (see also section 3.2): **GRAI**

3.9.4 Global Individual Asset Identifier (GIAI): AI (8004)

The GS1 Application Identifier (8004) indicates that the GS1 Application Identifier data field contains a GIAI (Global Individual Asset Identifier). The GIAI is used for the unique identification of individual assets.

 **Note:** Note: This element string must never be used to identify the entity as a trade item or logistic unit. If an asset is transferred between parties, the GIAI cannot be used for ordering the asset. However, asset identification may be exchanged between parties for the purpose of traceability.

The GS1 Company Prefix (see section 1.4.4) is allocated by GS1 Member Organisations to the company that allocates the GIAI – here the asset owner or manager. It makes the number unique worldwide.

The structure and content of the individual asset reference is at the discretion of the asset owner or manager. It may contain all characters listed in Figure 7.11-1.

Figure 3.9.4-1. Format of the element string

GS1 Application Identifier	Global Individual Asset Identifier (GIAI)														
	GS1 Company Prefix						Individual asset reference								
8 0 0 4	N ₁	...	N _i	X _{i+1}	...	variable length	X _j (j<=30)								

The data transmitted from the barcode reader means that the element string denoting a GIAI has been captured. When indicating this element string in the non-HRI text section of a barcode label, the following data title SHOULD be used (see also section 3.2): **GIAI**

3.9.5 Price per unit of measure: AI (8005)

The GS1 Application Identifier (8005) indicates that the GS1 Application Identifier data field contains a price per unit of measure. This element string is used to indicate the price per unit of measure of price marked goods on a variable measure trade item to discriminate price variants of the same item. It is considered as an attribute of the respective trade item and not as part of its identification.

Content and structure of the price per unit of measure field are left to the discretion of the trading partners.

Figure 3.9.5-1. Format of the element string

GS1 Application Identifier	Price per unit of measure
8 0 0 5	N ₁ N ₂ N ₃ N ₄ N ₅ N ₆

The data transmitted from the barcode reader means that the element string denoting the price per unit of measure has been captured. As this element string is an attribute of a trade item, it must be processed together with the GTIN of the trade item to which it relates (see section 3.3.2). When indicating this element string in the non-HRI text section of a barcode label, the following data title SHOULD be used (see also section 3.2): **PRICE PER UNIT**

3.9.6 Identification of an individual trade item piece: AI (8006)

The GS1 Application Identifier (8006) indicates that the GS1 Application Identifier data field contains the identification of an individual piece of a trade item. The piece is not traded independently and therefore cannot be assigned its own GTIN.

The GTIN that is included in this element string is the GTIN for the complete trade item.

The piece number identifies an individual piece of the trade item. The total count provides the total number of individual pieces of the trade item.

Figure 3.9.6-1. Format of the element string

GS1 Application Identifier	Global Trade Item Number (GTIN)	Piece number	Total count
8 0 0 6	N ₁ N ₂ N ₃ N ₁₂ N ₁₃ N ₁₄	N ₁₅ N ₁₆	N ₁₇ N ₁₈

The data transmitted from the barcode reader means that the element string denoting the identification of an individual piece of a trade item has been captured. This element string is normally processed as stand-alone information. When indicating this element string in the non-HRI text section of a barcode label, the following data title SHOULD be used (see also section 3.2): **ITIP or GCTIN**

Note: ITIP is the preferred data title for AI (8006) and GCTIN will have a sunset date of January 2020.

3.9.7 International Bank Account Number (IBAN): AI (8007)

The GS1 Application Identifier (8007) indicates that the GS1 Application Identifier data field contains the international bank account identifier.

The International Bank Account Number (IBAN), AI (8007), defined as *ISO 13616*, indicates to which account the amount of the respective payment slip is to be transferred. The invoicing party determines the applicable bank account number. The data field is alphanumeric and may contain all characters contained in [Figure 7.11-1](#).

Figure 3.9.7-1. Format of the element string

GS1 Application Identifier	International Bank Account Number
8 0 0 7	X—————variable length—————>X ₃₄

The data string transmitted by the barcode reader means that the element string denoting an IBAN has been captured. This element string must be processed together with the payment slip reference number, AI (8020), and the GLN of the invoicing party, AI (415). When indicating this element string in the non-HRI text section of a barcode label, the following data title SHOULD be used (see also section 3.2): **IBAN**

3.9.8 Date and time of production: AI (8008)

The GS1 Application Identifier (8008) indicates that the GS1 Application Identifier data fields contain a date and time of production (or assembly). The date and time of production is determined by the manufacturer. The date and time may refer to the trade item itself or to the items contained. The structure is:

- Year: the tens and units of the year (e.g., 2000 = 00), which is mandatory.
- Month: the number of the month (e.g., January = 01), which is mandatory.
- Day: the number of the day of the relevant month (e.g., second day = 02), which is mandatory.
- Hour: the number of the hour based on local time (e.g., 2 p.m. = 14), which is mandatory.
- Minutes: may be dropped if not required.
- Seconds: may be dropped if not required.

 **Note:** This element string can only specify dates ranging from 49 years in the past to 50 years in the future. Determination of the correct century is explained in section [7.12](#).

Figure 3.9.8-1. Format of the element string

GS1 Application Identifier	Date and time of production					
	YY	MM	DD	HH	MM	SS
8 0 0 8	N ₁ N ₂	N ₃ N ₄	N ₅ N ₆	N ₇ N ₈	N ₉ N ₁₀	N ₁₁ N ₁₂

The data transmitted from the barcode reader means that the element string denoting a date and time of production has been captured. As this element string is an attribute of a trade item, it must be processed together with the GTIN of the trade item to which it relates. When indicating this element string in the non-HRI text section of a barcode label, the following data title SHOULD be used (see also section [3.2](#)): **PROD TIME**

3.9.9 Component / Part Identifier (CPID): AI (8010)

The GS1 Application Identifier (8010) indicates that the GS1 Application Identifier data field contains the C/P Identifier.

The GS1 Company Prefix is allocated by GS1 Member Organisations to the company that allocates the C/P Identifier, making the number unique worldwide.

The structure and content of the C/P reference is at the discretion of the company that has been assigned the GS1 Company Prefix to uniquely identify each C/P.

The C/P reference format is variable length. The Component & Part reference SHALL only consist of numeric, alphabetic upper-case or special characters "#", "-", or "/", see [Figure 7.11-2](#).

Figure 3.9.9-1. Format of the element string

GS1 Application Identifier	Component / Part Identifier	
	GS1 Company Prefix	C/P reference number
8 0 1 0	N ₁ ...	N _j X _{j+1} ...variable length X _k (k<=30)

The data transmitted from the barcode reader means that the element string denoting a C/P Identifier has been captured. When indicating this element string in the non-HRI text section of a barcode label, the following data title SHOULD be used (see also section [3.2](#)): **CPID**

3.9.10 Component / Part Identifier serial number: AI (8011)

The GS1 Application Identifier (8011) indicates that the GS1 Application Identifier data field contains a C/P serial number. A C/P serial number is assigned to an entity for its lifetime. When combined with a C/P Identifier, a serial number uniquely identifies an individual item. The C/P serial

number field is numeric only. The C/P Identifier issuer (e.g. C/P buyer or OEM) determines the C/P serial number.

The C/P serial number SHALL NOT begin with a "0" digit, unless the entire serial number consists of the single digit "0".

Figure 3.9.10-1. Format of the element string

GS1 Application Identifier	Component / Part Identifier serial number
8 0 1 1	N_1 —variable length— N_{12}

The data transmitted from the barcode reader means that the element string denoting a C/P serial number has been captured. As this element string is an attribute of a C/P Identifier, it must be processed together with the C/P Identifier of the C/P to which it relates. When indicating this element string in the non-HRI text section of a barcode label, the following data title SHOULD be used (see also section 3.2): **CPID SERIAL**

3.9.11 Software version: AI (8012)

The GS1 Application Identifier (8012) indicates that the GS1 Application Identifier data field contains a software version number. Software versioning is the process of assigning unique version numbers to unique states of computer software.

Examples include:

- Software versions for regulated healthcare device software.
- Commercially available office productivity software (Microsoft® Word 2013 version 15.0.4701.1001, Adobe® Reader® XI version 11.0.10).

This AI may be combined with AI 10 (lot/batch) when the manufacturer decides that both lot and version control are required to meet regulatory or commercial requirements.

The data is alphanumeric and may include all characters contained in [Figure 7.11-1](#).

Figure 3.9.11-1. Format of the element string

GS1 Application Identifier	Software version
8 0 1 2	X_1 —variable length— X_{20}

The data transmitted by the barcode reader means that the element string denoting a software version has been captured. As this element string is an attribute of a software trade item, it must be processed with the GTIN of the software to which it is related. When indicating this element string in the non-HRI text section of a label, the following data title SHOULD be used (see also section 3.2): **VERSION**

3.9.12 Global Service Relation Number (GSRN): AIs (8017, 8018)

The GS1 Application Identifiers (8017, 8018) indicate that the GS1 Application Identifier data field contains a GSRN (Global Service Relation Number). The GSRN is used to identify either the recipient or individual provider of services in the context of a service relationship. In order to provide identification for both roles in a service relationship, recipient and provider, two GSRN AIs are available. The resultant element string provides a means for the service provider to store data relevant to services provided to the recipient and by the individual provider.

The GS1 Company Prefix is allocated by GS1 Member Organisations to the company that allocates the GSRN – here the organisation offering the service (see section 1.4.4). It makes the number unique worldwide.

The structure and content of the service reference is at the discretion of the organisation offering the service in order to uniquely identify each service relation.

The check digit is explained in section 7.9. Its verification, which must be carried out in the application software, ensures that the number is correctly composed.

The Global Service Relation Number – Provider (see figure below) identifies the relationship between an organisation offering services and the provider of services.

Figure 3.9.12-1. Format of the element string

GS1 Application Identifier	Global Service Relation Number (GSRN) - PROVIDER																	
	GS1 Company Prefix										Service reference							Check digit
8 0 1 7	N ₁	N ₂	N ₃	N ₄	N ₅	N ₆	N ₇	N ₈	N ₉	N ₁₀	N ₁₁	N ₁₂	N ₁₃	N ₁₄	N ₁₅	N ₁₆	N ₁₇	N ₁₈

The data transmitted from the barcode reader means that the element string denoting the Global Service Relation Number for the Provider has been captured.

When indicating this element string in the non-HRI text section of a barcode label, the following data title SHOULD be used (see also section 3.2): **GSRN – PROVIDER**

The Global Service Relation Number – Recipient identifies the relationship between an organisation offering services and the recipient of services.

Figure 3.9.12-2. Format of the element string

GS1 Application Identifier	Global Service Relation Number (GSRN) - RECIPIENT																	
	GS1 Company Prefix										Service reference							Check digit
8 0 1 8	N ₁	N ₂	N ₃	N ₄	N ₅	N ₆	N ₇	N ₈	N ₉	N ₁₀	N ₁₁	N ₁₂	N ₁₃	N ₁₄	N ₁₅	N ₁₆	N ₁₇	N ₁₈

The data transmitted from the barcode reader means that the element string denoting Global Service Relation Number for the Recipient has been captured. When indicating this element string in the non-HRI text section of a barcode label, the following data title SHOULD be used (see also section 3.2): **GSRN - RECIPIENT**

3.9.13 Service Relation Instance Number (SRIN): AI (8019)

The GS1 Application Identifier (8019) indicates that the GS1 Application Identifier data field contains a Service Relation Instance Number (SRIN). The SRIN is used when the identification of a “Subject of Care” Global Service Relation Number for the Service Recipient (GSRN - RECIPIENT) needs to be further qualified with a sequence indicator during the episode of care. The SRIN is further used when an identification (e.g. a badge) of a “Provider of Care” with Global Service Relation Number for the Service Provider (GSRN - PROVIDER) needs to be decommissioned and a replacement issued. The resultant element string provides a means for the organisation issuing badges to distinguish between badges with identical GSRNs.

The structure and content of the Service Relation Instance Number is at the discretion of the organisation offering the service, in order to uniquely identify each service relation instance.

Figure 3.9.13-1. Format of the element string

GS1 Application Identifier	Service Relation Instance Number
8 0 1 9	N ₁ —variable length—> N ₁₀

The data transmitted from the barcode reader means that the element string denoting a Service Relation Instance Number has been captured. When indicating this element string in the non-HRI text section of a barcode label, one of the following data title SHOULD be used as appropriate (see also section 3.2): **SRIN**

3.9.14 Payment slip reference number: AI (8020)

The GS1 Application Identifier (8020) indicates that the GS1 Application Identifier data field contains a payment slip reference number.

The payment slip reference number, assigned by the invoicing party, identifies a payment slip within a given Global Location Number (GLN) of an invoicing party. Together with the GLN of the invoicing

party, the payment slip reference number uniquely identifies a payment slip. The data field is alphanumeric and may contain all characters contained in [Figure 7.11-1](#).

Figure 3.9.14-1. Format of the element string

GS1 Application Identifier	Payment slip reference number
8 0 2 0	X ₁ ——variable length——> X ₂₅

The data string transmitted from the barcode reader means that the element string denoting a payment slip reference number has been captured. This element string must be processed together with the GLN of the invoicing party, AI (415).

When indicating this element string in the non-HRI text section of a barcode label, the following data title SHOULD be used (see also section [3.2](#)): **REF NO.**

3.9.15 Coupon code identification for use in North America (AI 8110)

See GS1 US for the *North American Coupon Application Guideline using GS1 DataBar Expanded Symbols* for detailed information on GS1 US coupon code data content.

The coupon barcode is constructed by starting with a coupon GS1 Application Identifier (8110), followed by the required and optional data elements, until all desired data is encoded (or the limit of 70 digits is reached).

Figure 3.9.15-1. Format of the element string

GS1 Application Identifier	Formatted according to rules of North American Coupon Application Guideline using GS1 DataBar Expanded Symbols
8 1 1 0	X ₁ ——variable length——>X ₇₀

The data string transmitted from the barcode reader means that the element string denoting a Coupon code for use in North America has been captured.

3.9.16 Loyalty points of a coupon: AI (8111)

The GS1 Application Identifier (8111) indicates that the GS1 Application Identifier data field contains the loyalty points of a coupon.

Figure 3.9.16-1. Format of the element string

GS1 Application Identifier	Loyalty points of a coupon
8 1 1 1	N ₁ N ₂ N ₃ N ₄

The data string transmitted from the barcode reader means that the element string denoting the loyalty points of a coupon has been captured. This element string must be processed together with the Global Coupon Number, AI (255) of the coupon to which it relates.

When indicating this element string in the non-HRI text section of a barcode label, the following data title SHOULD be used (see also section [3.2](#)): **POINTS**

3.9.17 Paperless coupon code identification for use in North America (AI 8112)

See GS1 US for the *North American Coupon Application Guideline using GS1 DataBar Expanded Symbols* for detailed information on GS1 US coupon code data content.

The paperless coupon data string is constructed by starting with a coupon GS1 Application Identifier (8112), followed by the required and optional data elements, until all desired data is encoded (or the limit of 70 digits is reached).

Figure 3.9.17-1. Format of the element string

GS1 Application Identifier	Formatted according to rules of North American Coupon Application Guideline using GS1 DataBar Expanded Symbols
8 1 1 2	X ₁ ———variable length—————>X ₇₀

The data string transmitted means that the element string denoting a paperless coupon code for use in North America has been captured.

3.9.18 Extended packaging URL: AI (8200)

The GS1 Application Identifier (8200) indicates that the GS1 Application Identifier data fields contain the identification of a brand owner authorised URL to be used in mandatory association with GTIN AI (01) encoded in one symbol.

Figure 3.9.18-1. Format of the element string

GS1 Application Identifier	Brand owner authorized URL
8 2 0 0	X ₁ ———variable length—————>X ₇₀

The data transmitted from the barcode reader means that the element string denoting the Extended Packaging URL for a trade item has been captured. This element string SHALL be processed as specified in section [2.1.8](#) to obtain one URL address associated with the trade item identified by the GTIN.

When indicating this element string in the non-HRI text section of a barcode label, the following data title SHOULD be used (see also section [3.2](#)): **PRODUCT URL**

3.10 GS1 Application Identifiers starting with digit 9

3.10.1 Information mutually agreed between trading partners: AI (90)

The GS1 Application Identifier (90) indicates that the GS1 Application Identifier data field contains any information mutually agreed between trading partners.

The data field shows the information agreed between the two trading partners. The field is alphanumeric and may contain all characters contained in [Figure 7.11-1](#). It may also be used to incorporate data preceded by ASC MH10 Data Identifiers.

Figure 3.10.1-1. Format of the element string

GS1 Application Identifier	Data field
9 0	X ₁ ———variable length—————>X ₃₀

The data transmitted from the barcode reader means that the element string denoting mutually agreed information has been captured. As this element string may contain any information, processing is subject to prior agreement between trading partners.

 **Important:** The barcode carrying this element string SHOULD be removed from any item that leaves the jurisdiction of the trading partners.

When indicating this element string in the non-HRI text section of a barcode label, the following data title SHOULD be used (see also section [3.2](#)): **INTERNAL**

 **Note:** The actual data title may be specified by the issuer of the data.

3.10.2 Company internal information: AIs (91 - 99)

The GS1 Application Identifier (A1 A2) assigned to company internal information is AI (91 to 99).

The GS1 Application Identifier data field may contain any company internal information. The field is alphanumeric and may show all characters contained in [Figure 7.11-1](#).

Figure 3.10.2-1. Format of the element string

GS1 Application Identifier	Data field
A ₁ A ₂	X ₁ ——variable length——> X ₉₀

 **Note:** Use of this Application Identifier for field lengths greater than 41 data characters will require the appropriate data carrier selection, see section [2.6.10](#).

The data transmitted from the barcode reader means that the element string denoting company internal information has been captured. Processing of this element string is to be organised by the using company.

 **Important:** This element string SHOULD be removed from any item that leaves the jurisdiction of the company.

When indicating this element string in the non-HRI text section of a barcode label, the following data title SHOULD be used (see also section [3.2](#)): **INTERNAL**

 **Note:** The actual data title may be specified by the issuer of the data.

3.11 Compatibility of EPC Tag Data Standard and GS1 General Specifications

The GS1 Application Identifiers, defined in this section of the *GS1 General Specifications*, may be used in GS1 endorsed GS1 barcodes in line with the application standards outlined in section 2. GS1 Application Identifiers may also be used in GS1 endorsed RFID tags as defined in the latest version of the *EPC Tag Data Standard* that can be found on: <http://www.gs1.org/standards>

4 Application rules and management practices

4.1	Introduction.....	179
4.2	Rules for keys	180
4.3	GTIN rules.....	181
4.4	SSCC rules.....	188
4.5	Rules for GS1 asset identifiers	188
4.6	GLN rules	190
4.7	GSRN rules	193
4.8	GDTI rules.....	194
4.9	GINC rules.....	195
4.10	GSIN rules.....	195
4.11	GCN rules	195
4.12	CPID rules.....	195
4.13	Data relationships	196
4.14	Human readable interpretation (HRI) rules	202
4.15	Multiple barcode management practices for consumer trade items (cross-sector) ..	207

4.1 Introduction

The main purpose of Automatic Data Capture (ADC) is to replace manual entry of visually captured information. This implies that an ADC message has to provide all information required for a transaction without human intervention. GS1 system data may be used, for example, to record entities in computer files, to sort goods on conveyor belts, to check completeness of a consignment, to verify dates, and to record physical stock taking.

Element strings may be applied directly on physical goods or printed in catalogues or documents. The scanning source and the type of transaction determine the required information in a given business application. Since all ADC data is being used in Electronic Data Processing (EDP) applications, strict validation of data to be processed is an absolute prerequisite.

For correct processing of scanned data, certain business applications may require the association of element strings representing a particular combination of identification data. The GS1 system enables users to achieve the needed level of data accuracy through the use of adequate element strings.

The logical set up of the data standard of the GS1 system enables system users to validate scanned data messages (see section 7, *AIDC validation rules*).

Validation is affected on two levels. The first is validation of the data for conformity with system rules (e.g., to provide a message that contains all information to be processed logically without human intervention). The second level is validation of the data for conformity with the requirements of a particular business application.

Sections [4.13.1](#) and [4.13.2](#) show the rules for the first verification level (e.g., validate data to conform with the system logic). Section [4.13.1](#) defines the pairs of element strings that cannot appear on the same physical entity. Section [4.13.2](#) defines the element strings that mandate the appearance of another element string on the same physical entity. All other combinations of element strings are possible at the first level of verification, although they may not make sense at the second, the application level.

4.2 Rules for keys

The tables in the sub-sections below summarise the rules for each of the GS1 identification keys.

4.2.1 GTIN rules

Rules	Section / Link
Management of uniqueness	4.3.1
Allocating the numbers	4.3.2
Responsibility for allocating the Global Trade Item Number	4.3.3
Sector-specific rules	4.3.4
Lead time in reusing a GTIN	4.3.5
Data alignment	4.3.6
GTIN Management Standard	http://www.gs1.org/gtinrules

4.2.2 SSCC rules

Rules	Section
Allocating Serial Shipping Container Codes	4.4.1

4.2.3 Rules for GS1 asset identifiers

Rules	Section
GS1 asset identifiers	4.5.1.1
Lead time in reusing GS1 asset identifiers	4.5.1.2
Responsibility	4.5.1.3
Allocating Global Returnable Asset Identifiers (GRAIs): AI (8003)	4.5.2
Allocating Global Individual Asset Identifiers (GIAIs): AI (8004)	4.5.3
Change of asset ownership	4.5.4
Information associated with asset identifiers	4.5.5

4.2.4 GLN rules

Rules	Section / Link
Allocation general rule	4.6.1.1
Assigning GLN values	4.6.1.2
Relocations	4.6.1.3
Grouping of Global Location Numbers	4.6.1.4
Locations without Global Location Numbers	4.6.1.5
Lead time in reusing a Global Location Number	4.6.1.6
Information associated with a Global Location Number	4.6.2
GLN Allocation rules	4.6.3
GLN Allocation Rules Standard	https://www.gs1.org/1/glnrules

4.2.5 GSRN rules

Rules	Section
General rule	4.7.1.1
Changes in a service relationship	4.7.1.2
Recommendation for allocating Global Service Relation Numbers	4.7.1.3

Rules	Section
Information associated with a Global Service Relation Number	4.7.1.4

4.2.6 GDTI rules

Rules	Section
Allocating Global Document Type Identifiers	4.8.1
GDTI change rules	4.8.2

4.2.7 GINC rules

Rules	Section
Allocating Global Identification Numbers for Consignment	4.9.1

4.2.8 GSIN rules

Rules	Section
Allocating Global Shipment Identification Numbers	4.10.1

4.2.9 GCN rules

Rules	Section
Allocating Global Coupon Numbers	4.11.1

4.2.10 CPID rules

Rules	Section
Allocating Component/Part Identifiers	4.12.1

4.3 GTIN rules

4.3.1 Management of uniqueness

Global Trade Item Numbers (GTINs) must be allocated uniquely. GTINs SHOULD not contain any intelligence or parsable strings. The embedding of internal codes is discouraged because it is often found that the rules for changing them differ from the rules for changing a GTIN.

For some product types (e.g., Healthcare items) it is common for national regulators to require the submission of a product filing from a party based within the jurisdiction of the regulator. Such arrangements have no direct impact on GTIN Management but need to be covered by the normal contractual arrangements (e.g., licenced distributor, subsidiary, reseller).

4.3.2 Allocating the numbers

A Global Trade Item Number (GTIN) is used to identify any item (trade item or service) upon which there is a need to retrieve predefined information and that may be priced or ordered or invoiced at any point in any supply chain. A separate, unique GTIN is required whenever any of the predefined characteristics of an item are different in any way that is relevant to the trading process.

The details on when to change a GTIN are included in the Global Item Number (GTIN) Management Standard that is designed to help industry make consistent decisions about the unique identification of trade items in open supply chains. The GTIN Management Standard defines when GTIN changes

are needed at the retail consumer trade item level (base unit) as well as on higher level trade items (e.g., case, pallet) that currently exist and are used in distribution processes.

The GTIN Management Standard as well as specific standard rules that apply to Upstream, Fresh Foods, and Healthcare can be found at <http://www.gs1.org/gtinrules>.

Local, national or regional regulations may require more frequent GTIN changes. Such regulations have precedence over the rules provided within the GTIN Management Standard.

4.3.2.1 GTIN Management definitions

The following terms may be useful when reviewing the GTIN Management Standard that is published on <http://www.gs1.org/gtinrules>:

- **Trade item** – Any item (product or service) upon which there is a need to retrieve predefined information and that may be priced, ordered, or invoiced at any point in any supply chain.
- **Retail consumer trade item** – The trade item intended to be sold to the end consumer at retail point-of-sale. They are identified with a unique GTIN-13, GTIN-12, or GTIN-8. (See the section 2).
- **Retail consumer trade item variant** – A change to a retail consumer trade item (which may itself be a homogeneous or predefined assortment of other retail consumer trade items) which does not require a new GTIN, but where identification of the variation may be required.
- **Trade item grouping** – A grouping of retail consumer trade items that is not intended for point-of-sale scanning. It is identified with a unique GTIN-14, GTIN-13, or GTIN-12.
- **Non-GTIN pack** – A packaging level for trade items where there is no trading partner requirement for Global Trade Item Number (GTIN) identification. If a GTIN is required, then this item becomes a retail consumer trade item or trade item grouping.
- **Logistic unit** – An item of any composition established for transport and/or storage that needs to be managed through the supply chain. It is identified with an SSCC (Serial Shipping Container Code).

✓ **Note:** The GTIN Management Standard is intended for global use. Exceptions may occur only when local regulatory or legal requirements mandate otherwise.

4.3.2.2 Predefined characteristics

Although this list is not exhaustive, the basic predefined characteristics of a trade item are:

- The primary brand or, as may be defined by regulation (product name, product description).
- The trade item type and variety.
- The net content of trade item (weight, volume, or other dimension impacting trade).
- If the trade item is a grouping, the number of elementary items contained, and their subdivision in sub-packaging units.

A modification to any of the basic elements that characterise a trade item will usually lead to a change in the Global Trade Item Number (GTIN).

✓ **Note:** These rules are intended for global use. Exceptions may occur only when local regulatory or legal requirements mandate otherwise. For example, in some industries, such as healthcare, regulations or other requirements may dictate that any trade item changes require a new GTIN.

✓ **Note:** For complex products, such as some medical devices, key consideration for GTIN Allocation is the commercialisation of the product (e.g., different for pricing or ordering or invoicing). If the product is 'different' a 'different GTIN' is required. The figure below is a scenario to represent the difficulties in determining when a GTIN change is necessary for complex medical devices, depending upon how the device is viewed (i.e., from a commercial

and/or form, fit, function perspective). Nominally the commercial aspects of an item determine a GTIN change, the objective is to recognise that other important factors reside which may not necessarily signify a commercialisation shift, but would impact the GTIN assignment – particularly in the healthcare industry. It is the brand owner’s responsibility to manage appropriately the configuration of any complex device and its appropriate GTIN(s) assignment. The example shows major hardware components managed by GTIN and serial number combinations, recognising that within this complex medical device there are other potential parameters where configuration change must be managed; GTIN change may be dictated based on the manufacturers change management process. It is the brand owner that decides upon the identification requirement.

Figure 4.3.2.2-1. Example of the complexity of a medical device product with regard to GTIN allocation

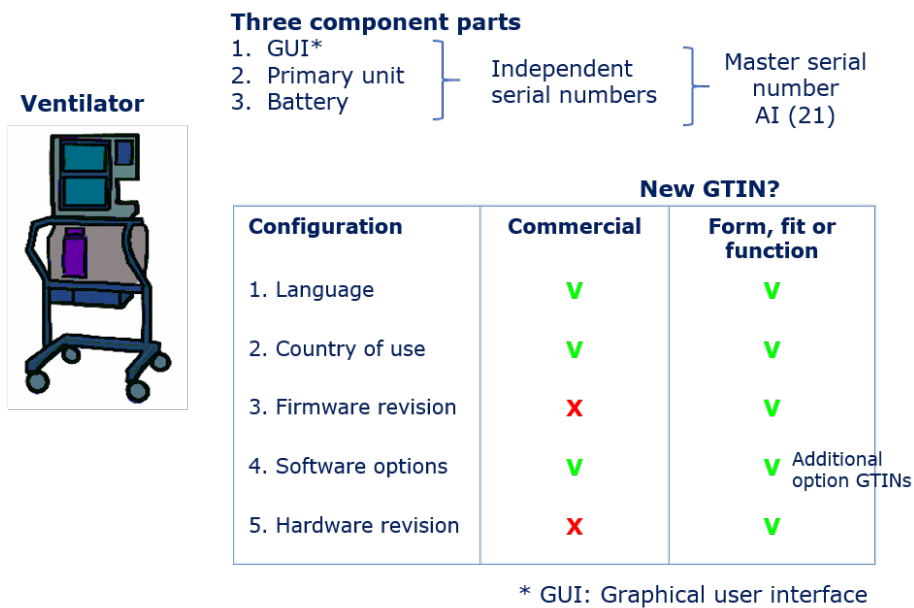

4.3.2.3 Trade item variants

4.3.2.3.1 Consumer product variants

Per brand owner discretion, a consumer product variant (CPV) if used, SHALL be used with GTIN on retail consumer trade items in the following conditions:

1. A CPV may be assigned by the brand owner to a variation of a retail consumer trade item, which SHALL NOT require a new GTIN per the GTIN Management Standard, but where communication regarding the variation may be required.
2. Each retail consumer trade item variation SHALL NOT have more than one CPV value.
3. CPV may be assigned to retail consumer trade items that contain a homogeneous quantity or predefined assortment of retail consumer trade items.
4. When a retail consumer trade item is offered in different quantities (e.g., unit, six pack, 12 pack) the various packages for these quantities are each identified with a unique GTIN. Those packages may also each include a unique CPV, and the actual data value for the CPV may or may not be the same between the various packages.
5. The CPV of a retail consumer trade item that contains a homogeneous quantity or predefined assortment of retail consumer trade items may change independently from the CPV of the contained retail consumer trade items, but shall change if the CPV of any of the contained retail consumer trade item changes.

4.3.2.3.2 Minor trade item variants for trade item groupings

For trade item groupings containing units that are themselves minor trade item variants of trade items whose GTINs remain unchanged, the rule is the following:

If the identification of minor trade item variants is only relevant to the manufacturer, they SHOULD distinguish these variants by using the element string internal product variant, AI (20). Examples include minor package design changes and side loading as opposed to top loading cases.

4.3.3 Responsibility for allocating the Global Trade Item Number

4.3.3.1 Responsibility for branded items

The brand owner, the organisation that owns the specifications of the trade item regardless of where and by whom it is manufactured, is normally responsible for the allocation of the Global Trade Item Number (GTIN). On joining a GS1 Member Organisation, the brand owner licences a GS1 Company Prefix, which is for the sole use of the company to which it is assigned.

The brand owner is the organisation that owns the trade item specifications and may be:

- The manufacturer or supplier: The company that manufactures the trade item or has it manufactured, in any country, and sells it under its own brand name.
- The importer or wholesaler: The importer or wholesaler that has the trade item manufactured, in any country and sells it under its own brand name or the importer or wholesaler that changes the trade item (for example by modifying the packaging of the trade item).
- The retailer: The retailer that has the trade item manufactured, in any country, and sells it under its own brand.

4.3.3.2 Responsibility exceptions and non-branded items

There are some exceptions to the rules regarding responsibility described in:

- **Non-branded items:** Items without a brand name and generic items (not private labels) are still assigned Global Trade Item Numbers (GTINs) by their manufacturer. As different manufacturers and/or suppliers may supply items that appear identical to the buyer (this could be a consumer as well as a retailer or manufacturer), it is possible that items that are apparently the same have different GTINs. Companies that trade in these items need to organise their computer applications (e.g., replenishment programs) to cope with this eventuality. Examples of items that sometimes have no brand are apples, plasterboard, candles, and drinking glasses. Examples for trade items that sometimes have no brand and are not intended for retail include salt, fragrances, and food cans.
- **Customer specific items:** If a trade item is made specifically for one trade customer (buyer) and is orderable only by this customer, then the buyer assigns the GTIN. In this case the GTIN SHOULD be formed from the customer's GS1 Company Prefix (see section [1.4.4](#)). If the supplier (seller) sells a trade item to more than one buyer or intends to sell to more than one buyer, then the seller assigns the GTIN.
- **Other exceptions:** If the brand owner does not assign a GTIN, the importer or another intermediary can assign an item a temporary GTIN. This would imply that the importer takes on the role of the brand owner and could, for example, register the product in a data catalogue. This temporary GTIN may be used until a GTIN is assigned in the normal way. Alternatively, a retail organisation can assign an internal number to an item that does not yet have a GTIN assigned to it only if the item is used within its own stores.

4.3.4 Sector-specific rules

4.3.4.1 GTIN allocation rules for healthcare

Specific rules that apply to healthcare trade items can be found in the *Healthcare GTIN Allocation Rules* publication found at <http://www.gs1.org/1/gtinrules/index.php/p=static/t=healthcare>.

4.3.4.2 GTIN allocation rules for upstream suppliers

Specific rules that apply to packaging and raw material trade items supplied to manufacturing companies can be found on <http://www.gs1.org/1/gtinrules/en/tree/29/upstream>.

Upstream suppliers are those companies that typically supply or manufacture trade items that are supplied to other companies for further processing. Examples of these trade items include raw ingredient and packaging materials.

A Global Trade Item Number (GTIN) must be assigned to each predefined trade item and any unit of measure used in the price, order, or invoice process.

 **Note:** These rules are intended for global use. Exceptions may occur only when local regulatory or legal requirements mandate otherwise.

4.3.4.3 GTIN allocation considerations for Apparel and Home Fashion

The GSMP General Merchandise Work Team validated the original Global Trade Item (GTIN) allocation rules and concluded that they are applicable to the apparel and home fashions product category. The content of this section extends the content in section 4.3 to cover scenarios specific to apparel and home fashions and may be different in other sectors. This section is the result of the review of the Trade Item Identification and Communication Guidelines (VICS EDI) TIIC, May 2001, by the GSMP Work Team.

4.3.4.3.1 Pre-pack/multi-pack/set-pack for Apparel and Home Fashion

For a pre-pack or assortment of trade items, each different item within the pre-pack will be assigned a GTIN maintaining the one-to-one relationship between trade item/colour ID/size ID and GTIN. Each GTIN must be marked so as to enable scanning at the point-of-sale. A separate, unique GTIN is assigned to each orderable pre-pack. This GTIN is not intended to be scanned at the retail point-of-sale. Different pre-packs of trade items are assigned different GTINs when either the component item or quantity contents of the pre-packs are different.

A multi-pack is a group of trade items (the same or different) that are intended to be sold as a single consumer unit at the point-of-sale (e.g., a three-pack of men's white T-shirts or a 12-piece set of glassware). A multi-pack is not intended to be broken apart and sold as individual trade items. A multi-pack is assigned a GTIN that is different from the GTIN that may be assigned to the individual trade items. Generally components of a multi-pack are not marked with individual GTINs. Each different multi-pack of the same trade items (e.g., three-pack socks versus six-pack socks) must have a different GTIN assigned. Each different multi-pack GTIN must also have its own trade item/colour ID/size ID.

For a set-pack, each different trade item within the set-pack will be assigned a GTIN, maintaining the one-to-one relationship between trade item/colour ID/size ID and the GTIN. The individual trade item GTIN must be marked to enable retail point-of-sale scanning and may or may not be orderable separately outside the set-pack(s). A separate, unique GTIN is assigned to each set-pack. Different set-packs are assigned different GTINs when either the trade item or quantity contents are different. The figure below provides a summary of the requirements.

Figure 4.3.4.3.1-1. Requirements by pack type

Pack	Individual items of the pack					
	Orderable by retailer	Sellable to consumer	GTIN marked	Orderable by retailer	Sellable to consumer	GTIN marked
Pre-pack	Yes	No	Yes	Maybe	Yes	Yes
Multi-pack	Yes	Yes	Yes	No	No	No
Set-pack	Yes	Yes	Yes	Maybe	Yes	Yes

 **Note:** GTINs on individual trade items in a multi-pack are optional.

- ✔ **Note:** GTINs in a set-pack are required because the individual pieces are available for sale to the consumer.
- ✔ **Note:** Individual components of pre-packs and set-packs may be ordered separately based on individual partnership agreement.

4.3.4.3.2 Gift with purchase/purchase with purchase/collateral item for Apparel and Home Fashion

A gift with purchase is a trade item given to a consumer as part of a promotional event, contingent on the consumer making a purchase of another item or items. A gift with purchase is considered inventory and has no retail value.

A purchase with purchase is a trade item sold to a consumer at a special price as part of a promotional event, contingent on the consumer purchasing another item or items. A purchase with purchase is considered inventory and has a retail value. When assigning and tracking Global Trade Item Numbers (GTINs) for gift with purchase and purchase with purchase trade items, GTINs SHOULD be assigned to all gift with purchase and purchase with purchase items and be marked with a GTIN to enable point-of-sale scanning.

A collateral item is a trade item delivered from a manufacturer to the retail selling floor that is not considered inventory and has no retail value (e.g., a display case that needs to be identified but has no retail value). GTINs SHOULD be assigned to all collateral items.

4.3.4.4 GTIN allocation considerations for direct marking

The master data linked to the GTIN marked on the item (see section [2.1.4 Direct Marking](#)) will generally apply for the item at time of production and first purchase. The master data will no longer apply when changes are made to the trade item (refurbishment, upgrade, memory extension, etc.). When such changes are made the GTIN as marked on the item MAY remain the same, and companies will need to ensure that it is clear to all parties which master data may change over time.

4.3.5 Lead time in reusing a GTIN

A GTIN allocated to a trade item that has become obsolete must not be reused for another trade item until at least 48 months have elapsed after:

- the expiration date of the last original trade items produced with that number
- or-
- the last original trade items produced with that number have been supplied to the customer.

The following sector-specific rules apply:

- Apparel: In the case of clothing the minimum retention period is reduced to 30 months.
- Healthcare: Companies must ensure that GTINs allocated to regulated healthcare trade items SHALL never be reused.

Exception: regulated healthcare trade items that have been withdrawn from the market and are reintroduced may use the original GTIN if they are reintroduced without any modifications or changes which require a new GTIN as specified by the GTIN Management Standard.

- Technical industries: GTINs that are marked directly on components and parts, such as used in rail rolling stock and infrastructure, SHALL never be reused (also see [2.1.4 Direct marking](#)).

For other trade items, brand owners should consider a longer period depending upon the type of goods and/or any regulatory framework. For example, steel beams may be stored for many years before entering the supply chain, and processes should be put in place to ensure that the GTIN is not reallocated for a significant period of time.

In addition, when contemplating the reuse of a GTIN, consideration should be given to the use of data associated with the original GTIN by trading partners for statistical analysis or service records, which may continue long after the original trade item was last supplied.

If a GTIN has been assigned to an item, which was then never actually produced, the GTIN may be deleted from any catalogue immediately without first being marked as discontinued. In this exceptional case the GTIN may be reused 12 months after deletion from the seller's catalogue.



Important: The standard for GTIN Reuse will be changed in December 2018: a GTIN allocated to a trade item SHALL NOT be reallocated to another trade item. The only exceptions include:

- If a GTIN has been assigned to an item, which was then never actually produced, the GTIN may be deleted from any catalogue immediately without first being marked as discontinued. In this exceptional case, the GTIN may be reused 12 months after deletion from the seller's catalogue.
- Trade items that have been withdrawn from the market and are reintroduced may use the original GTIN if they are reintroduced without any modifications or changes that require a new GTIN as specified by the GTIN Management Standard.

4.3.6 Data alignment

When a new Global Trade Item Number (GTIN) is assigned to a trade item, it is essential that the brand owner provide the detailed information to trading partners about the item's characteristics. This information should be provided at as soon as possible before the trade item is actually traded. Expediting GTIN information to buyers reduces order exception handling and reduces the lead time in getting goods to the selling floor.

4.3.6.1 Data alignment best practice

A number of actions are vital to ensure that Global Trade Item Numbers (GTINs) are accurately communicated within the supply chain. These ensure that the data associated with any scanned barcode can be associated with accurate, up-to-date data. This is particularly essential for items scanned at the point-of-sale where the absence of accurate data may have legal implications.

The GTIN provides a supply chain solution for the identification of any item that is traded (priced, invoiced, or ordered). Overall supply chain costs are minimised by all partners in the supply chain adhering to identical GTIN Management Standards (see section [4.3](#)).

The following best practices are proposed for all items. It has been developed by manufacturers, distributors, and retailers to help eliminate any confusion between product identification and product listing in the retailer's database in the supply chain.

1. GTIN Management and the barcoding of the GTIN are technical processes with rules detailed in these *GS1 General Specifications*. Product listing is the act of adopting a new product in an assortment by a commercial organisation. Product listing is the result of commercial negotiations between purchaser and seller. For example, GTIN Management should be independent from product listing.
2. For management reasons, or to ensure that correct information is communicated to the final consumer, changes to an item may require a new GTIN. A new GTIN does not automatically imply a new listing. For example, if a change requiring a new GTIN is made to a listed product, this should not automatically imply a new product listing is needed.

GTIN Management and database listing are to be considered as two entirely autonomous decisions: GTIN Management is not an object of negotiation.

The brand owner makes available to its client all information regarding the listed items, ideally with an EDI message or in an e-product catalogue, no later than at the time of item listing. In case of time limited promotions or a product evolution, this information will be communicated largely beforehand, thus allowing the retailer to validate this information and to circulate it internally.

4.4 SSCC rules

4.4.1 Allocating Serial Shipping Container Codes

4.4.1.1 General rule

An individual Serial Shipping Container Code (SSCC) is a unique number, which remains the same for the life of the logistic unit to which it is assigned. When assigning an SSCC, the rule is that an individual SSCC number must not be reallocated within one year of the shipment date from the SSCC assignor to a trading partner. However, prevailing regulatory or industry organisation specific requirements may extend this period.

4.4.1.2 Responsibility

The Serial Shipping Container Code (SSCC) provides functionality to support the management (tracking, tracing, storage, etc.) of logistic units through the supply chain. To ensure global uniqueness and traceability, the physical builder of the logistic unit or the brand owner of the logistic unit is responsible for the allocation of the SSCC.

4.5 Rules for GS1 asset identifiers

4.5.1 General rule

4.5.1.1 GS1 asset identifiers

GS1 asset identifiers can be used to identify any fixed assets of a company. It is left to the discretion of the issuer to determine whether the Global Returnable Asset Identifier (GRAI), AI (8003), or Global Individual Asset Identifier (GIAI), AI (8004), is more suitable for the application concerned.

4.5.1.2 Lead time in reusing GS1 asset identifiers

Asset identifiers must not be used for any other purpose and must remain unique for a period well beyond the lifetime of the relevant records. If a company assigns asset identifiers to trade items supplied to its customers, the company must ensure that the asset identifiers are never reused.

All issuers of asset identifiers must ensure that asset identifiers (GRAIs, GIAIs) allocated for medical devices / equipment used for treatment of a patient SHALL never be reused.

Also GIAIs that are marked directly on safety critical components and parts, such as used in rail, SHALL never be reused.

4.5.1.3 Responsibility

The asset owner or manager is responsible for the issuance and allocation of GS1 asset identifiers.



Note: The term 'asset manager' includes manufacturers that issue and allocate asset identifiers to be used during the full lifetime of the asset. Furthermore, best practices may dictate that the trade item manufacturer applies the asset identifiers issued by the asset owner or manager during the manufacturing process (see section [2.3](#)).

4.5.2 Allocating Global Returnable Asset Identifiers (GRAIs): AI (8003)

The structure of the element string for a Global Returnable Asset Identifier (GRAI) can include two parts: the mandatory identification of an asset type and an optional serial component, to distinguish individual assets within the same asset type (see section [2.3.1](#))

Figure 4.5.1.3-1. Format of the element string

GS1 Application Identifier	Global Returnable Asset Identifier (GRAI)																
	GS1 Company Prefix			Asset type	Check digit	Serial component (optional)											
8 0 0 3	0	N ₁	N ₂	N ₃	N ₄	N ₅	N ₆	N ₇	N ₈	N ₉	N ₁₀	N ₁₁	N ₁₂	N ₁₃	X ₁	variable	X ₁₆

The exact method used to allocate the GRAI is left to the discretion of the issuing organisation. However, a unique number, the asset type, must be assigned for each type of asset being identified, and for ease of administration, the GS1 system recommends that numbers be allocated sequentially and not contain classifying elements.

When it is not possible to assign an asset type (e.g., for museum exhibits), or when the type of asset is not required by the application (e.g., when the item is only used for a single type of asset), then the Global Individual Asset Identifier (GIAI), AI (8004), SHOULD be used.

To encode the following examples of identification keys in a GS1-128 barcode a zero in the leftmost position must be added to generate the defined length for the 14-digit asset identification number field.

4.5.2.1 Identical assets identification

A single Global Returnable Asset Identifier (GRAI) SHOULD be assigned to a series of identical assets.

Figure 4.5.2.1-1. Examples of GRAI excluding serial number

Asset type	GRAI
50 litre aluminium beer keg	1234567890005
10 litre aluminium beer keg	1234567890012
10 litre wooden beer keg	1234567890029

4.5.2.2 Serial component (optional)

The asset owner or manager assigns the optional serial component. It denotes an individual asset within a given asset type. The field is alphanumeric and is used to distinguish individual assets with the same asset types.

Figure 4.5.2.2-1. Examples of GRAI including serial component

Asset Type	GRAI (incl. the serial component)
50 litre aluminium beer keg	12345678900051234AX01
50 litre aluminium beer keg	12345678900051234AX02
50 litre aluminium beer keg	12345678900051234AX03

4.5.3 Allocating Global Individual Asset Identifiers (GIAIs): AI (8004)

The Global Individual Asset Identifier (GIAI) is structured according to figure 4.5.3 - 1.

Figure 4.5.3-1. Format of the element string

GS1 Application Identifier	Global Individual Asset Identifier (GIAI)						
	GS1 Company Prefix		Individual asset reference				
8 0 0 4	N ₁	...	N _i	X _{i+1}	...	variable length	X _j (j<=30)

The exact method used to allocate the GIAI is left to the discretion of the issuing organisation. However, each GIAI must be unique for each individual asset being identified and, for ease of

administration, the GS1 system recommends that GIAIs be allocated sequentially and not contain classifying elements.

4.5.4 Change of asset ownership

Asset identification numbers are used in a diverse range of business applications ranging from tracking the movements of reusable packaging trays to recording the life-cycle history of aircraft parts.

If a company sells an asset to another company then the asset identifier SHOULD ideally be replaced by another Global Individual Asset Identifier (GIAI) or Global Returnable Asset Identifier (GRAI) or be removed.

It is permissible for the asset identifier to remain on the item when the ownership changes if the new owner takes responsibility for the GS1 Company Prefix associated with the asset identifier, or when the asset identifier was assigned by the manufacturer.

For further information regarding changes of ownership, please refer to section [1.6](#).

4.5.5 Information associated with asset identifiers

The data related to the asset should be recorded and shared digitally using the asset identifier as the key to the information. Examples of the type of information held include the GLN of the party who owns or manages the asset, the value of the asset, the location of the asset, and the life-cycle history of the asset.

4.6 GLN rules

4.6.1 Allocating Global Location Numbers

4.6.1.1 Allocation general rule

Global Location Numbers (GLNs) can be used to identify any location that has meaning within a business scenario. The term location is used in a very wide sense, besides physical locations also covering IT systems, departments and legal entities.

The general rule is that a separate GLN is required whenever organisations need to be able to distinguish between one location and another (e.g., each store of a retail group is required to have a separate GLN to enable efficient delivery to the individual store).

GLNs must be allocated by the party that defined the location in support of their business operations.

- When representing itself in business transactions an organisation SHALL only use GLNs for which the organisation is licenced. For example, if a franchisee engages as buyer in business transactions with parties other than the franchising company it must use its own assigned GLN, it cannot use a GLN assigned by the franchising company.
- A company may assign a GLN to a physical location of which it is not the owner or primary user. This can be useful in cases where the same location is used for multiple purposes (e.g. a store is also used as receiving location for a mobile clinic).

Individual companies need to determine how they assign GLNs. A company may use a single GLN for order, delivery and invoice because each process is undertaken at the company (corporate) level. However, an organisation may also assign distinct GLNs to locations and functions within its organisation.

When a new GLN is issued, it is recommended that:

- The GLN be associated with the master data for the identified location.
- This master data be communicated to trading partners in a timely manner.

The GLN allocated to a location SHOULD be communicated throughout the supply chain by the company that allocated the GLN in advance of a transaction/delivery so that all systems can be prepared for this interaction.

From time to time, the details (associated data) related to a GLN might change. The following subsections are general cases, or examples, about GLN allocation due to a change in the circumstances or business conditions in which the number was originally established.

See section [4.6.3](#) for GLN allocation rules and scenarios regarding when GLNs should remain the same or should be changed. These rules are based on business practices.



Note: These rules are intended for global use. National, federal or local regulations may take precedence. Examples include regulations affecting a company's registration, taxation, or fiscal obligations, as well as its industry requirements.

4.6.1.2 Assigning GLN values

It is recommended to allocate GLNs sequentially without any classifying elements.

There is no need to coordinate GS1 identification key values across different GS1 identification keys. This is true even when the keys have an identical format. For example, there is no risk of conflict when a GTIN-13 and a GLN have the same value: GS1 Application Identifiers (barcodes), data qualifiers and XML tags (EDI) prevent misinterpretation.

4.6.1.3 Relocations

Relocations within the same building (e.g., a department moves from the second to the seventh floor of a building), or other changes in address that have little or no impact on such things as deliveries and payments, do not require assignment of a new GLN. The changed information may be updated and communicated to trading partners.

Whenever the point of access changes, a new GLN SHOULD be assigned. Also, when a given operation is closed in one location and replaced by a similar operation at a new location, a new GLN SHOULD be assigned.



Note: Address changes of legal entities or functions do not always require a new GLN. See section [4.6.3](#) for more information.

4.6.1.4 Grouping of Global Location Numbers

While companies, for their internal purposes, may collect Global Location Numbers (GLNs) into logical groupings, there are no supply chain standards to do so. GLNs are assigned at the discretion of GS1 user companies to support their business applications. The principle of non-significance (see the *GS1 Architecture Principles*⁴) is critical to supply chain use, and it therefore follows that any additions or deletions from the group do not impact individual GLN assignment.

4.6.1.5 Locations without Global Location Numbers

If a GLN is required, the party responsible for that location must allocate the GLN to it. Assigning the GLN at source by the responsible trading partner ensures supply chain efficiency.

If a trading partner responsible for a particular location does not have a GS1 Company Prefix, it must either request a GS1 Company Prefix or an individually assigned GLN from a GS1 Member Organisation. A GLN SHALL NOT be sold, leased, or loaned to a separate party.



Note: GS1 Member Organisations offer various alternatives by which a company can obtain its own GLN.

⁴ https://www.gs1.org/docs/architecture/GS1_Architecture_Principles.pdf

4.6.1.6 Lead time in reusing a Global Location Number

A Global Location Number (GLN) that has been previously used and has become obsolete must not be reused for another location until at least 48 months have elapsed. A longer period may be needed in accordance with government requirements, such as invoicing and taxation, or requirements related to the nature of the location (e.g., a bonded warehouse). This period provides time for all references of the old GLN to be removed from trading partner files.

All issuers of Global Location Numbers (GLNs) must ensure that GLNs allocated for locations used in the healthcare supply chain SHALL never be reused, e.g. locations where treatment of patients takes place, etc.

4.6.2 Information associated with a Global Location Number

GLNs are assigned to locations to provide a key to access master data in a business process (e.g., order, invoice, deliver). For each assigned GLN, master data will be assigned to support business processes.

Master data for a location should be established on a computer file and the Global Location Number (GLN) may then be used to facilitate efficient communication of this information.

The type of information held for physical locations, legal entities and function may include the name and address, bank details and account number, sales department, and company profile.

Changes to attributes of digital locations may have a large impact on trading partners. For example, if a retailer changes his Electronic Data Interchange (EDI) Value Added Network (VAN) provider, the accounting department will get a new VAN address to which invoices and payments have to be remitted. In the digital world, this is as significant a change as a physical address change in the physical world.

Information associated with each GLN is held internally by trading partners or on central databases. If the location changes and the details are not updated, communications or deliveries will go to the address held on file. Therefore it is essential for organisations to inform trading partners as soon as possible about new GLN assignments or changes to information associated with a GLN.

See section [4.6.3](#) for GLN allocation rules and scenarios where changes to a location or attributes relating to a GLN may require a new GLN.

4.6.3 GLN Allocation rules

The GLN Allocation Rules provide specific rules on GLN assignment per business scenario.

The business scenarios address various organisational and attribute data changes that may occur in practice. For each situation, the rules indicate whether a new GLN should be assigned or whether the change can be communicated in other ways, such as an EDI message or GLN registry.

The scenarios are organised as follows:

- General rules.
- Rules for legal entity GLNs.
- Rules for function GLNs.
- Rules for physical location GLNs.
- Rules for digital location GLNs.

The same GLN may be used to identify several location types, for example a physical location and a legal entity. The GLN allocation rules provide guidance on the allowed combinations and the way to address change scenarios involving multi-use GLNs.

The GLN Allocation Rules can be found at <http://www.gs1.org/glnrules>.



Note: These rules are intended for global use. Exceptions may occur only when local regulatory or legal requirements mandate otherwise.

4.7 GSRN rules

4.7.1 Allocating Global Service Relation Numbers

4.7.1.1 General rule

Global Service Relation Numbers (GSRNs) can be used to identify the service provider and/or service recipient in any service relationship. A separate, unique number can be issued, normally by the organisation offering the service to identify the service provider and/or the service recipient, to identify any given service relationship. Once assigned, the GSRN becomes a unique and universal reference that can be used by all parties involved in the service relationship.

A GSRN with either AI (8018) or AI (8017) are mutually exclusive, that is, a GSRN can only be assigned to a single role, recipient or provider, but not both.

4.7.1.2 Changes in a service relationship

From time to time the details related to a Global Service Relation Numbers (GSRNs) may change. The following are general cases that may occur if the circumstances under which the GSRN were originally set up change:

- if an organisation providing a service ceases trading (possibly because of liquidation), any GSRNs allocated by that organisation SHOULD be phased out. If the activity covered by the GSRN is transferred, the new organisation providing the service may continue to use existing GSRNs if it has taken over the GS1 Company Prefix of the original organisation providing the service; if not, the GSRN SHOULD be phased out and a new GSRN allocated using the new organisation's GS1 Company Prefix.
- if the range of services identified by a GSRN changes, the organisation that provides the service SHOULD change the details associated with the GSRN on the related computer file record. The assignment of a new GSRN is not required in this case.
- a GSRN used to identify a particular service relationship that has terminated SHOULD NOT be reallocated for a period well beyond the lifetime of the relevant records.

4.7.1.3 Recommendation for allocating Global Service Relation Numbers

The exact method used to allocate the Global Service Relation Number (GSRN) is left to the discretion of the issuing organisation. However, the GSRN must be unique for each individual service provider and for each individual service recipient and each must remain unique for a period well beyond the lifetime of the records relevant to the service relationship.

All issuers of Global Service Relationship Numbers (GSRNs) must ensure that GSRNs allocated for healthcare service providers and service recipients SHALL never be reused.

For ease of administration, GS1 recommends that GSRNs be allocated sequentially and not contain classifying elements.

4.7.1.4 Information associated with a Global Service Relation Number

Global Service Relation Number (GSRN) may be used as a standalone element strings where all information required is established on a computer file using the individual GSRN as the key to access the information. The type of information stored is determined by the nature of the service relationship. Typical information includes the service recipient's or provider's full name, address, and details of the services received or rendered.

If the identification of a Global Service Relation Number for the service recipient (GSRN) needs to be further qualified with a sequence indicator corresponding to specific encounters during a service relationship, a Service Relation Instance Number (SRIN), AI (8019) may be associated to the GSRN. In a healthcare setting this could be used to allow for differentiation of "Subject of Care" identification capture from an identification band, both before and after its replacement (i.e. due to a radiology examination, etc.) or to allow differentiation between the issuance of identification badges for "Provider of Care".

4.8 GDTI rules

4.8.1 Allocating Global Document Type Identifiers

The Global Document Type Identifier (GDTI) is used to identify any document for document control purposes. A separate, unique GDTI is required whenever any of the characteristics of a document are different in any way that is relevant to the business process. As a guiding principle, if the end user is expected to distinguish between documents and process them accordingly, each document SHOULD be allocated its own GDTI.

The Global Document Type Identifier (GDTI) is assigned by the document issuer. The GDTI is used as a key to access database information (normally held by the issuing organisation).

The same document type is used for all document classes that are issued with an identical purpose. This can then be used to reference the main characteristics of the document, such as:

- The exact right or obligation the document imposes.
- The document purpose (e.g., insurance policy, governmental paper, product image).

A different document type SHALL be used whenever the main characteristics of the document are different.

Example:

An application form for membership to an organisation would be identified with a specific document type, and all filled forms would be uniquely identified through the serial component.

If the limits of the membership were to change (now subject to legal constraints) the document type shall change, to document the modification. Subsequent applications with the modified form would then be tracked through the serial component.

The identification of each individually issued document requires a unique serial component in addition to the document type. Any duplicates of the individually issued document SHOULD use the same serial component as the original. The serial component is optional and assigned by the document issuer and is unique in a series of documents issued under the same Document Type. Ideally the serial component SHOULD be sequentially allocated for each new document generated. The serial component is used to communicate detailed characteristics pertinent to the individual document such as:

- The name and address of the recipient.
- The document details.

The definition of main characteristics (identified with the document type) and detailed characteristics (identified with the serial component) is at the discretion of the document issuer.

All issuers of Global Document Type Identifiers (GDTIs) must ensure that GDTIs allocated for documents relevant to patient treatment / care SHALL never be reused.

4.8.2 GDTI change rules

If the function, type, or major content (determined by the document issuer) of the document changes, the document type identifier SHALL change.

The document issuer will determine if changes to the content of the document require changing the document type identifier, or adding or changing a serial component.

Embedded metadata changes do usually not impact the functionality of the document, and are not considered content changes. These would not require a change in the GDTI.

4.9 GINC rules

4.9.1 Allocating Global Identification Numbers for Consignment

4.9.1.1 General rule

An individual Global Identification Number for Consignment is a unique number, which remains the same for the life of a grouping of logistics or transport units to which it is assigned. When assigning a GINC, the rule is that an individual GINC number must not be reallocated within one year of the shipment date from the freight forwarder assigning the GINC to a transport. However, prevailing regulatory or industry organisation specific requirements may extend this period.

4.10 GSIN rules

4.10.1 Allocating Global Shipment Identification Numbers

4.10.1.1 General rule

An individual Global Shipment Identification Number (GSIN) is a unique number, which remains the same for the life of the grouping of logistics or transport units to which it is assigned. When assigning a GSIN, the rule is that an individual GSIN number must not be reallocated within ten years of the shipment date from the seller or third party logistics provider (sender) of the GSIN to a trading partner buyer (recipient) to comply with the regulations of the World Customs Organisation (WCO). For goods that circulate within one country (domestic transport), the period of reuse is based on either governmental, industry or the discretion of the seller (sender) of the goods.

4.11 GCN rules

4.11.1 Allocating Global Coupon Numbers

The exact method used to allocate the Global Coupon Number (GCN) is left to the discretion of the issuing organisation. However, the GCN must remain unique for a period well beyond the lifetime of the records relevant to the coupon. For ease of administration, GS1 recommends that GCNs be allocated sequentially and not contain classifying elements.

4.12 CPID rules



4.12.1 Allocating Component/Part Identifiers

The exact method used to allocate the Component/Part Identifier (CPID) is left to the discretion of the issuing organisation.

4.13 Data relationships

The element strings that require specialised software and/or scanner set up are not covered by these rules. These are the element strings with GS1 Prefixes 0001 to 0007, 02, 04, 05, 20 to 29, 98, and 99; GTIN-8 Prefixes 0 and 2; two-digit and five-digit add-on symbols.

In figures 4.13.1-1 and 4.13.2-1, the GS1 Application Identifiers (AIs) are used to indicate the element string. The AI (01) is used to indicate a Global Trade Item Number (GTIN); however, the element strings that encode GTINs are defined in section 3. GTINs may be encoded in barcodes from the EAN/UPC symbology family, ITF-14 barcodes, GS1 DataBar symbology family, GS1 DataMatrix and GS1-128 barcodes using AI (01) or AI (8006) and GS1 QR barcodes using AI (01).

- 
Note: If duplicate element strings (e.g., two serial numbers, two batch/lot numbers, two Extended Packaging URLs) must appear on the same physical entity they must always have the same value in each occurrence on that entity.
- 
Note: It is possible to have multiple different National Healthcare Reimbursement Numbers (NHRNs), from different country or regional NHRN authorities, associated with the same GTIN on a given item. It is possible and permissible to change one of these NHRNs without a change to the other NHRNs or to the GTIN.
- 
Note: It is not allowed to have multiple of the same NHRN AI with different data associated with the same GTIN on a given item.

4.13.1 Invalid pairs of element strings

This section defines the pairs of element strings that cannot appear on the same physical entity.

Figure 4.13.1-1. Invalid pairs of element strings

Pair of element strings				Comment
AI	Designation	AI	Designation	
01	Identification of a trade item	01	Identification of a trade item	Duplicate Global Trade Item Numbers (GTINs) with different values
01	Identification of a trade item	02	Identification of logistic unit contents	AI (02) must not be used for the identification of trade items contained in a trade item.
01	Identification of a trade item	37	Count of units contained	The count of units contained would duplicate the master data of the GTIN. AI (37) may only be used with AI (02).
242	Made-to-Order variation number	01 or 02 with N ₁ not equal to 9	Identification of a variable measure trade item	Made-to-Order variation number can only be used with a GTIN-14, indicator digit 9. This represents a Custom Industrial Supply Item
420	Ship to postal code, single postal authority	421	Ship to postal code with ISO country code	Only one ship to postal code may be applied on an item
422	Country of origin of a trade item	426	Country of full processing	Duplication of country of origin of a trade item (covered by country of full processing)
423	Country of initial processing	426	Country of full processing	Duplication of country of initial processing (covered by country of full processing)
424	Country of processing	426	Country of full processing	Duplication of country of processing (covered by country of full processing)
425	Country of disassembly	426	Country of full processing	Duplication of country of disassembly (covered by country of full processing)

Pair of element strings				Comment
AI	Designation	AI	Designation	
390n	Amount payable or Coupon value – single monetary area	391n or 394n or 8111	Amount payable – with ISO currency code or Percentage discount of a coupon or Loyalty Points of a coupon	Only one amount payable element string may be applied on a payment slip or coupon and only one discount condition element string may be applied on a coupon
392n	Amount payable for a variable measure trade item – Single monetary area	393n	Amount payable for a variable measure trade item and ISO currency code	Only one amount payable element string may be applied on a variable measure trade item.
394n	Percentage discount of a coupon	390n or 8111	Coupon value or Loyalty points of a coupon	Only one discount condition element string may be applied on a coupon
710, 711, 712, 713 (...)	National Healthcare Reimbursement Number	Any AI (01) allowable attributes	Any GTIN allowable attributes	When NHRN(s) are applied to the physical trade item with the mandatory association to the GTIN, any attribute AIs must only be processed with the GTIN and must not be processed with the NHRNs (AIs 710, 711, 712, 713.....) alone.
8006	Identification of an individual trade item piece	01	Identification of a trade item	Other GTINs cannot be used with AI (8006). The trade item is identified by a GTIN contained in the AI (8006).
8111	Applicable loyalty points for coupon value	390n or 394n	Coupon value or Percentage discount of a coupon	Only one discount condition element string may be applied on a coupon
8018	Global Service Relation Number for the recipient	8017	Global Service Relation Number for the provider	Only one Global Service Relation Number (recipient or provider) can be applied at one time for identification of an individual in a given service relationship

4.13.2 Mandatory association of element strings

This section defines the element strings that mandate the appearance of another element string on the same physical entity.

Figure 4.13.2-1. Mandatory association of element strings

If element string		Then mandatory associated element string	Comment
AI	Designation		
01 with $N_1 = 0$	Identification of a variable measure trade item scanned at POS	30 or 3nnn* or 3nnn**	Mandatory association with a variable count or a trade measure information scanned at POS identified with GTIN-12 or GTIN-13. Only GS1 DataBar Expanded barcodes can encode associated elements strings for use at POS. (See note at bottom)
01 or 02 with $N_1 = 9$	Identification of a variable measure trade item not scanned at POS	30 or 3nnn* or 3nnn** or 8001	Mandatory association with variable measure information not scanned at POS identified with a GTIN-14 starting with indicator digit 9 (See Note at bottom) Only GS1-128, ITF-14, and GS1 DataBar Expanded barcodes can encode a GTIN with $N_1 = 9$.

If element string		Then mandatory associated element string	Comment
AI	Designation		
02	Identification of logistic unit contents	00	Mandatory association with an SSCC (Serial Shipping Container Code)
02	Identification of logistic unit contents	37	Mandatory count of the contained trade items
10	Batch/lot number	01 or 02 or 8006****	Mandatory association with a Global Trade Item Number (GTIN) or with the identification of logistic unit contents or with the identification of an individual trade item piece (*).
11, 13, 15, 16	Dates	01 or 02 or 8006****	Mandatory association with a GTIN or with the identification of logistic unit contents or with the identification of an individual trade item piece.
12	Due date	8020 and 415	Mandatory association with the payment slip reference number and the Global Location Number (GLN) of the invoicing party
17	Expiration date	01 or 02 or 255 or 8006****	Mandatory association with a GTIN or with the identification of logistic unit contents or with the Global Coupon Number or with the identification of an individual trade item piece.
20	Internal product variant	01 or 02 or 8006	Mandatory association with a GTIN or with the identification of logistic unit contents or with the identification of an individual trade item piece.
21	Serial number	01 or 8006****	Mandatory association with a GTIN of a single trade item (a serial number cannot apply to a grouping of trade items) or with the identification of an individual trade item piece. SGTIN is a common term for the mandatory association of AI (21) with GTIN AI (01)
22	Consumer product variant	01	The consumer product variant must appear in conjunction with AI (01) GTIN on retail consumer trade items.
240	Additional product identification	01 or 02 or 8006****	Mandatory association with a GTIN or with the identification of logistic unit contents or with the identification of an individual trade item piece.
241	Customer part number	01 or 02 or 8006****	Mandatory association with a GTIN or with the identification of logistic unit contents or with the identification of an individual trade item piece.
242	Made-to-Order variation number	01 or 02 or 8006**** with N ₁ = 9	Mandatory association with a GTIN-14 with indicator digit 9 represents a custom industrial supply item
243	Packaging Component Number	01	Mandatory association with GTIN
250	Secondary serial number	(01 or 8006****) and 21	Mandatory association with a GTIN (a secondary serial number cannot apply to a grouping of trade items) or identification of an individual trade item piece and the serial number of the trade item AI (21)
251	Reference to source entity	01 or 8006****	Mandatory association with GTIN of the trade item or with the identification of an individual trade item piece.
254	Extension component of a GLN	414	Mandatory association with AI (414). Only GS1-128, GS1 DataBar Expanded symbologies, and EPC RFID tags are valid. This is used with GLN and not GTIN.
30	Variable count of items	01 or 02	Mandatory association with a GTIN for a variable measure trade item (e.g., GTIN-12 or GTIN-13 for trade items scanned at POS, GTIN-14s starting with indicator digit 9 for trade items not scanned at POS) or the identification of variable measure content of a logistic unit

If element string		Then mandatory associated element string	Comment
AI	Designation		
3nnn*	Trade measures that cannot be summed	01	Mandatory association with a GTIN for a variable measure trade item (e.g., GTIN-12 or GTIN-13 for trade items scanned at POS, GTIN-14s starting with indicator digit 9 for trade items not scanned at POS)
3nnn**	Trade measures that can be summed	01 or 02	Mandatory association with a GTIN for a variable measure trade item (e.g., GTIN-12 or GTIN-13 for trade items scanned at POS, GTIN-14s starting with indicator digit 9 for trade items not scanned at POS) or the identification of variable measure content of a logistic unit
3nnn***	Logistic measures	00 or 01	Mandatory association with an SSCC or a variable measure GTIN for trade item not scanned at POS (e.g., a GTIN-14 starting with the digit 9)
337n	Kilograms per square metre	01	Mandatory association with a GTIN
37	Count of units contained	02	Mandatory association with the identification of logistic unit contents
390n	Amount payable or Coupon value – single monetary area	8020 and 415 or 255	Mandatory association with the payment slip reference number and the GLN of the invoicing party or with the Global Coupon Number
391n	Amount payable – with ISO currency code	8020 and 415	Mandatory association with the payment slip reference number and the GLN of the invoicing party
392n	Amount payable – when scanned at POS – single monetary unit	01	Mandatory association with a variable count or a trade measure scanned at POS when identified with a GTIN-12 or GTIN-13.
392n	Amount payable when not scanned at POS – single monetary unit	01	Mandatory association with a variable measure information when identified GTIN-14.
393n	Amount payable – when scanned at POS –with ISO currency code	01	Mandatory association with a variable count or a variable measure when scanned at POS and identified with GTIN-12 or GTIN-13.
393n	Amount payable when not scanned at POS – with ISO currency code	01	Mandatory association with a variable measure information when identified with a GTIN-14.
394n	Percentage of a coupon	255	Mandatory association with the Global Coupon Number
403	Routing code	00	Mandatory association with an SSCC
415	GLN of the invoicing party	8020	Mandatory association with payment slip reference number
422	Country of origin	01 or 02 or 8006****	Mandatory association with a GTIN or with the identification of an individual trade item piece.
423	Country of initial processing	01 or 02	Mandatory association with a GTIN or with the identification of logistic unit contents
424	Country of processing	01 or 02	Mandatory association with a GTIN or with the identification of logistic unit contents

If element string		Then mandatory associated element string	Comment
AI	Designation		
425	Country of disassembly	01 or 02	Mandatory association with a GTIN or with the identification of logistic unit contents
426	Country of full processing	01 or 02	Mandatory association with a GTIN or with the identification of logistic unit contents
427	Country subdivision of origin code for a trade item	01 or 02 and 422	Mandatory association with a GTIN and the Country of Origin of the trade item
7001	NATO stock number	01 or 02 or 8006****	Mandatory association with a GTIN or with the identification of logistic unit contents or with the identification of an individual trade item piece.
7002	UN/ECE meat carcasses and cuts classification	01 or 02	Mandatory association with a GTIN or with the identification of logistic unit contents
7003	Expiration date and time	01 or 02	Mandatory association with a GTIN or with the identification of logistic unit contents
7004	Active potency	01 and 10	Mandatory association with the GTIN and Batch/lot number
7005	Catch Area	01 or 02	Mandatory association with a GTIN or with the identification of logistic unit contents
7006	First freeze date	01 or 02	Mandatory association with a GTIN or with the identification of logistic unit contents
7007	Harvest date	01 or 02	Mandatory association with a GTIN or with the identification of logistic unit contents
7008	Species for fishery purposes	01 or 02	Mandatory association with a GTIN or with the identification of logistic unit contents
7009	Fishing Gear type	01 or 02	Mandatory association with a GTIN or with the identification of logistic unit contents
7010	Production method	01 or 02	Mandatory association with a GTIN or with the identification of logistic unit contents
703(s)	Number of processor	01 or 02	Mandatory association with a GTIN or with the identification of logistic unit contents
710	National Healthcare Reimbursement Number	01	Mandatory association with the GTIN of the trade item
711	National Healthcare Reimbursement Number	01	Mandatory association with the GTIN of the trade item
712	National Healthcare Reimbursement Number	01	Mandatory association with the GTIN of the trade item
713	National Healthcare Reimbursement Number	01	Mandatory association with the GTIN of the trade item
7020	Refurbishment lot ID	(01 or 8006****) and 416	Mandatory association with the GTIN or identification of an individual trade item piece and GLN of production / service location.
7021	Functional status	01 or 8006****	Mandatory association with the GTIN or identification of an individual trade item piece.

If element string		Then mandatory associated element string	Comment
AI	Designation		
7022	Revision status	(01 or 8006****) and 7021	Mandatory association with the GTIN or identification of an individual trade item piece and functional status.
8001	Variables of roll products	01	Mandatory association with a variable measure GTIN (e.g., an GTIN-14 starting with the digit 9)
8005	Price per unit of measure	01 or 02	Mandatory association with a GTIN for a variable measure trade item (e.g., GTIN-12 or GTIN-13 for trade items scanned at POS, GTIN-14s starting with indicator digit 9 for trade items not scanned at POS) or the identification of variable measure content of a logistic unit.
8007	International Bank Account Number	8020 and 415	Mandatory association with the payment slip reference number and the GLN of the invoicing party
8008	Date and time of production	01 or 02	Mandatory association with a GTIN or with the identification of logistic unit contents
8011	Component / Part Identifier serial number	8010	Mandatory association with Component / Part Identifier
8012	Software Version	01 or 8006****	Mandatory association with a GTIN or with the identification of an individual trade item piece.
8019	Service Relation Instance Number	8017 or 8018	Mandatory association with a Global Service Relation Number (GSRN)
8020	Payment slip reference number	415	Mandatory association with the GLN of the invoicing party
8111	Loyalty points of a coupon	255	Mandatory association with the Global Coupon Number
8200	Extended packaging URL	01	Mandatory association with GTIN

*	Is (3nnn) where the first three digits are 312, 313, 324, 325, 326, 327, 328, and 329
**	Is (3nnn) where the first three digits are 310, 311, 314, 315, 316, 320, 321, 322, 323, 350, 351, 352, 356, 357, 360, 361, 364, 365, and 366
***	Is (3nnn) where the first three digits are 330, 331, 332, 333, 334, 335, 336, 340, 341, 342, 343, 344, 345, 346, 347, 348, 349, 353, 354, 355, 362, 363, 367, 368, and 369
****	If used, optional AIs on all pieces of a trade item and on the trade item itself SHALL be identical.



Note: Exception for point-of-sale. See figure 2.7–1. Areas of GS1 system application.

4.14 Human readable interpretation (HRI) rules

Human readable interpretation (HRI) rules are provided to standardise printing requirements and facilitate training of staff on how to deal with GS1 AIDC data carriers that fail to scan or read. There are two categories of rules:

- General rules that apply independent of sector, product category, or region.
- Sector specific rules which must be aligned with the general rules.

For the purposes of interpreting this standard, there are two types of text that appear on a label, package, or item; human readable interpretation (HRI) and non-HRI text.

- Human readable interpretation (HRI) is the information below, beside or above a barcode or tag which is encoded in the barcode or tag and represents the same characters as carried in the barcode or tag (See section 8 *Glossary* for full definition).
- Non-HRI text is all other text on package, label or item (See section 8 *Glossary* for full definition).

Figure 4.14-1. Example of HRI and non-HRI text

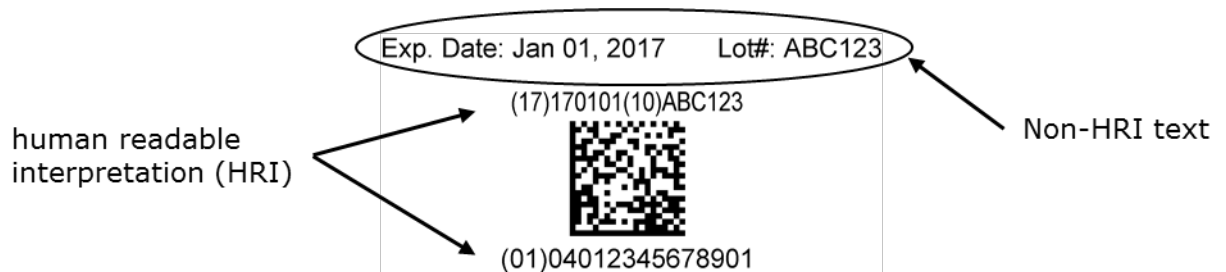

- ✓ **Note:** The following rules are intended for global use. Exceptions may occur only when local regulatory or legal requirements mandate otherwise.
- ✓ **Note:** At present, HRI rules are applicable to barcodes as rules for EPC/RFID tags are under development.
- ✓ **Note:** HRI rules for the EAN/UPC symbology and the add-on symbols are explained in section [5.2.3 Human Readable Interpretation](#).

Human readable interpretation rules

- **Rule 1.** Whether a GS1 AIDC data carrier encodes a GS1 identification key, GS1 key attributes, or a combination of both, the HRI SHOULD be placed below the barcode and grouped together wherever physically possible while maintaining the HRI legibility and minimum barcode height (as specified in the appropriate symbol specification table referenced by the GS1 AIDC application standard).
 - a. In cases where the HRI must be printed above, to the left, or to the right of the symbol due to packaging or space constraints, HRI SHALL always be printed adjacent to (obviously associated with) the GS1 AIDC data carrier while protecting Quiet Zones.
 - b. If the HRI for GS1 identification keys and GS1 key attributes is split (for example GS1 key HRI is below the barcode and GS1 key attributes HRI is above the barcode), the preference for GS1 key HRI placement is always below the barcode.
 - c. When HRI is grouped together (for example, all HRI data is grouped below the barcode or all HRI data is grouped above the barcode), HRI SHALL always follow the encoding sequencing of the GS1 AIDC data carrier.
- **Rule 2.** A single data element SHALL NOT be broken into two lines of HRI, for example the data for a serial number would appear on one line of HRI.
- **Rule 3.** Parentheses SHALL surround AIs in HRI but are not encoded in the GS1 AIDC data carrier.

- **Rule 4.** A clearly legible font SHALL be used (e.g., OCR-B as defined in *ISO 1073-2*) and the character set as defined in section [7.11](#). Reasonable alternative type fonts and character sizes are acceptable provided the interpretation is clearly legible.
- **Rule 5.** On GS1 Logistics Labels HRI characters SHALL be no less than 3 mm (0.1181 inch) high
- **Rule 6.** HRI SHALL be limited to element strings and will not include GS1 AIDC data carrier overhead such as separator characters.
- **Rule 7.** If the required barcode and associated HRI is marked directly on the part, then both satisfy the requirements for healthcare primary package marking (see section [2.1.2.3](#)) if the barcode can be scanned and the HRI is legible through a panel in the primary packaging.
- **Rule 8.** HRI SHALL appear except in rare circumstances for specific applications where there are extreme space constraints (e.g., direct part marking). If the GS1 AIDC data carrier cannot be read or scanned and the HRI does not appear on the label, package, or item, non-HRI text SHOULD be used as backup information.

As a non-HRI text option, the data title (see section [3.2](#)) may be associated with the data instead of using the AI numbers. See figure 4.14-1 which shows expiry date and lot number identified with non-HRI text and in the same figure where the same data is shown using the all-AI format. These presentations can be used with all GS1 AIDC data carriers using GS1 Application Identifiers, except GS1-128 symbology.

- **Rule 9.** For symbols (Composite symbol, GS1 DataMatrix) encoding a large amount of data, it may not be practical to display all the data in human readable interpretation form or, even if there is space to show it in this form, it may not be practical to key enter that much data. In these instances, some of the data may be omitted from the human readable interpretation. However, primary identification data (GS1 system keys) such as the Global Trade Item Number (GTIN) or Global Document Type Identifier (GDTI) must always be shown. Application specifications provide guidance on human readable interpretation.

Figure 4.14-2. HRI with some of the data omitted

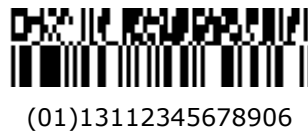

- **Rule 10.** If the barcode is printed in ladder orientation on the product, the HRI SHOULD remain clearly associated with the barcode and may appear below, to the left, or to the right of the symbol respecting Quiet Zones. See figure below.

Figure 4.14-3. Locations of HRI for barcode in ladder orientation



- ✓ **Note:** There may be local variants for non-HRI text on the label (e.g., dates, prices) which are formatted based on local practice rather than the way the data is encoded in GS1 AIDC

data carriers. In this case, the HRI associated with AIDC SHALL still be expressed as it is encoded in the GS1 AIDC data carrier encodation (per GS1 Application Identifier definition).

- **Rule 11.** When AI (8200) appears on the label, the expression of the URL SHALL NOT appear in HRI. If it appears in non-HRI text, it SHALL be expressed as <http://brandownerassignedURL.com/GTIN> (where GTIN expressed as 14 digits).

4.14.1 Healthcare human readable interpretation rules

The GS1 system requires printing both the GS1 AIDC data carrier and the HRI that represents all the information encoded within that GS1 AIDC data carrier.

If the GS1 AIDC data carrier cannot be read or scanned, the HRI should be used as back up information. The GS1 preferred format for HRI when applied on healthcare trade items SHALL be as noted in the general HRI rules found in section [4.14](#).

When considering the practical implementation and application of HRI during the creation of the product packaging, many factors must be taken into account to determine if and how HRI is included with the symbol. These factors may include the type of product being labelled or marked, product use, available space for marking, alternate data availability, regulatory or legal requirements, technical constraints, etc.

However, printing both the GS1 AIDC data carrier and the associated HRI may not be possible due to many factors such as the intended use of the item, available space for marking, etc. Deviation from the HRI format should be minimised and consider impacts to downstream trading partners and users

Typical examples are shown the figure below.

Figure 4.14.1-1. Preferred HRI format examples



If a deviation from the preferred format is required that results in HRI not being printed, then a combination of HRI and non-HRI text may be used. When doing so, the following rules apply:

- If the data represented in the non-HRI text is exactly as in the HRI, then the appropriate AI SHALL be printed along with the data title. See figure 4.14.1-2.
- If data represented in the non-HRI text does not match the HRI, then only a data title may be used. The AI SHALL NOT be printed. This is illustrated in figure 4.14.1-3 by the GTIN and Expiry.
- The selection of data titles may be determined by the manufacturer based on regulatory, local language requirements, relevant standards (e.g. *ISO/IEC 15223*) or appropriate abbreviations.

Figure 4.14.1-2. Combination of HRI with AIs, non-HRI text and data titles

GTIN (01) 09504000059101
 SERIAL (21) 12345678p901
 LOT (10) 1234567p
 EXPIRY (17) 141120



Scan for online product information or go to:
<http://www.gs1.org/demo/09504000059101/>

Figure 4.14.1-3. Combination of HRI with AIs, non-HRI text (GTIN and Expiry) and data titles

GTIN 9504000059101
 SERIAL (21) 12345678p901
 LOT (10) 1234567p
 EXPIRY 20 Nov 2014



Scan for online product information or go to:
<http://www.gs1.org/demo/09504000059101/>

If it is not possible to print both the GS1 AIDC data carrier and the HRI, figure 4.14.1-4 SHOULD be used to determine how HRI will be implemented. When it is not possible to print all of the HRI, preference for printing SHALL be given to the GS1 key.

Figure 4.14.1-4. Healthcare human readable interpretation (HRI) decision tree
 (to be used only when limited space is available)

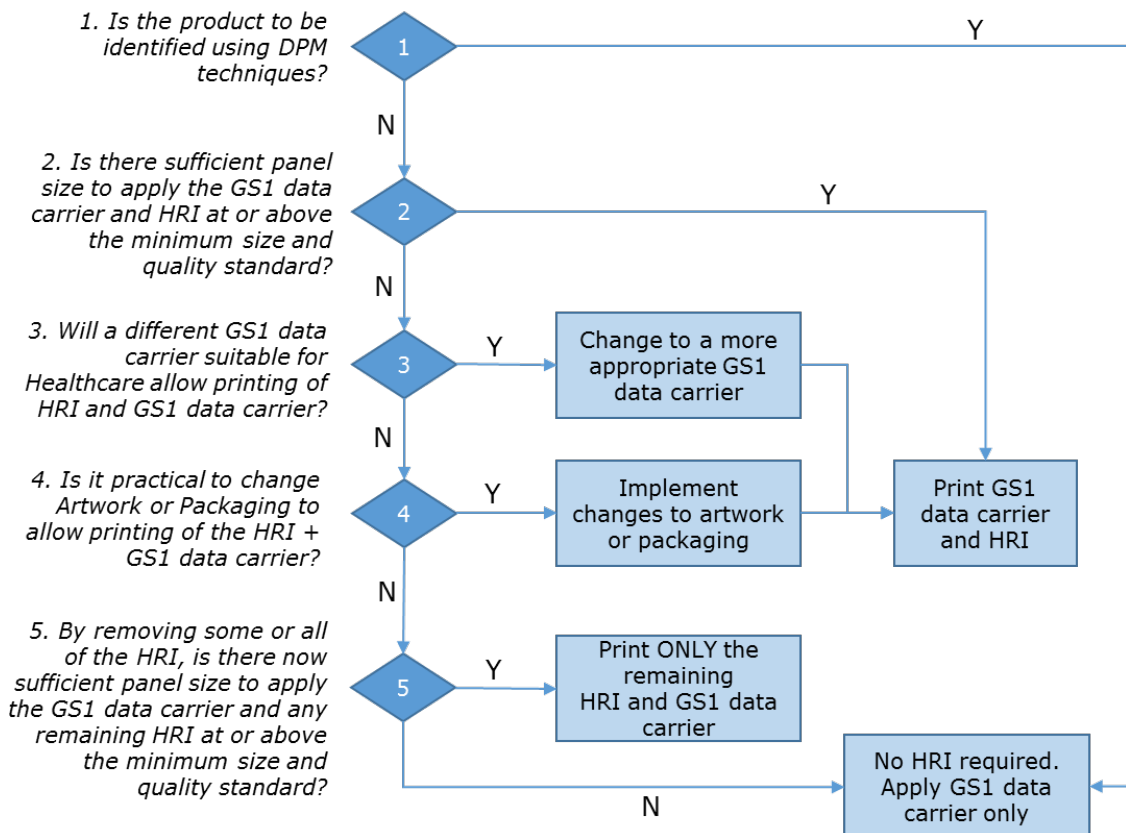

Note: Figure 4.14.1-1 is intended for use when there is no regulatory mandate that conflicts with this guidance and where space constraints limit the ability to provide both the GS1 AIDC

marking and the associated HRI text—this document does not impact the non-HRI text that is required for compliance with labelling regulations. In all situations, applicable regulatory requirements SHALL take precedence. Brand owners are responsible to understand and comply with applicable regulations and to document deviations from those regulations and their justifications for such deviations in the product master record files or other formal document control files.



Note: Active potency, AI (7004) HRI rule. Printing of the active potency on the item is controlled by regulation. Human readable interpretation of the active potency is not required on the trade item.

4.14.2 Manual date marking

Where regulations and/or trade partner agreements require applied date markings for stock rotation and manual identification, the ISO standard (8601) for date sequence SHOULD be used. The format SHOULD be YYYY-MM-DD preceded by the date type short form (See figure 4.14.2-1 below for respective date types) based on ISO standard abbreviations (15223).

Figure 4.14.2-1. Short forms by date type

Date type	Short form
Production	PROD
Packaging	PACK
Best Before	BEST
Expiration	EXP

AIDC techniques are suggested over any manual process to ensure accurate and timely stock rotation. Every effort should be made to adopt an automated process to increase productivity and date management.

4.15 Multiple barcode management practices for consumer trade items (cross-sector)

EAN/UPC symbols have been used for POS/POC and will continue to be used for existing applications however new symbologies have been introduced to support new application requirements. Until all parties can process GTIN using the new technologies, existing technology must be supported while new technology migration occurs. This standard provides a set of management practices intended to permit the use of existing and new technologies on one package, in order to avoid the need for separate inventories.

In addition to supporting POS/POC and general distribution scanning applications, consumer trade item packages may now support additional business processes using barcodes. For example, support for B2C extended packaging and trade item production control. For this reason, a management practices has been introduced to separate, where possible, symbols for different functions and in the case of production control barcodes, another management practice is introduced to obstruct their supply chain scanning or make them obscure where possible.

The transition to use of additional data beyond GTIN in barcodes is a non-trivial step for the retail and healthcare industry. It means operators must learn to handle the new technologies and systems must be adapted to process them. The management practices were designed after considering the different types of scanner systems, testing over 170 symbols combinations, and the ways each interact with each other and the operator.

In section [4.15.1](#), practices 1, 6, and 7 apply now and in the future. Section [4.15.2](#), practice 1 and section [4.15.3](#), practice 1 and 2, once implemented, will eliminate the need for section [4.15.1](#) practices 2-5 as they are present to support a migration period.

4.15.1 Multiple barcode management practices for consumer trade items (all sectors)

- 1. Current standards:** All scanning systems SHALL deploy symbology identifiers (see section [5.1.2](#)) and when using GS1 Application Identifiers, process them according to GS1 rules (see section [7.8](#)).
- 2. GTIN plus attribute(s) flag:** Where applications require additional data be captured in a multiple barcode symbol environment, modifications to systems should be made to automate this requirement to optimise efficiency.
- 3. Adjacent placement:** Wherever two symbols can be used for the same application (POS, POC) they SHOULD be placed adjacent to one another. Adjacent placement of symbols SHALL never infringe on symbol Quiet Zones. The orientation (stack or row of symbols) or sequence (which symbol is placed on the left, right, top, or bottom) and shall be determined by the brand owner. Where adjacent placement on one panel is not permitted based on space limitations, placement on adjacent panels SHOULD be attempted. This practice does not supersede any section 6 symbol placement rule (e.g.: 8mm (0.3in) free space between symbols and panel edge.)
- 4. Non-adjacent placement:** Wherever two symbols are used for different applications (POS, B2C Extended Packaging (EP) Direct Mode), they SHOULD be placed non-adjacent to one another.
- 5. Obscure placement:** Wherever a symbol is used for product control purposes only, it SHOULD be made as obscure as possible or even obstructed on the consumer trade item package.
- 6. Product URL barcode indication:** For barcodes encoding AI (01) (8200) see section [4.14](#) Human readable interpretation rules, rule 9.)
- 7. GS1-128 use as secondary symbol when EAN/UPC or ITF-14 is required.**
In general distribution, where EAN/UPC and/or ITF-14 is used to encode GTIN and where GS1-128 is used to encode GTIN attributes, the GTIN SHOULD also be encoded in the GS1-128 encoding GTIN attributes but GTIN is not required based on previous standards based implementations.



Note: Where GS1 DataBar and GS1 DataMatrix are used, GTIN and GTIN attributes shall be concatenated to ensure accurate data association.

4.15.2 GS1 multiple barcode management practice for general retail

- **GTIN in GS1 DataBar processing:** In order to facilitate migration away from a multiple barcode environment where one retailer requires EAN/UPC and another GS1 DataBar Expanded, at a minimum, all general retailers SHALL be able to process the AI (01) GTIN from GS1 DataBar Expanded.

4.15.3 GS1 multiple barcode management practices for healthcare

1. **GTIN in GS1 DataMatrix and GS1 DataBar processing (retail healthcare):** In order to facilitate migration away from a multiple barcode environment where one retail pharmacy requires EAN/UPC and another retail pharmacy requires GS1 DataMatrix or GS1 DataBar Expanded, at a minimum, retail pharmacies SHALL have the capability to process the AI (01) GTIN from GS1 DataMatrix and GS1 DataBar in addition to the capability for EAN/UPC.
2. **GTIN in GS1 DataMatrix, GS1 DataBar, and GS1-128 processing (non-retail healthcare):** In order to facilitate migration away from a multiple barcode environment where one healthcare provider requires EAN/UPC or ITF-14 and another healthcare provider requires GS1 DataMatrix, GS1 DataBar Expanded, or GS1-128, at a minimum, non-retail pharmacies SHALL have the capability to process AI (01) GTIN from GS1 DataMatrix, GS1 DataBar, and GS1-128 in addition to the capability for EAN/UPC and ITF-14.
3. **GS1-128 as secondary symbol:** In point-of-care applications, where EAN/UPC or ITF-14 is used to encode GTIN and where GS1-128 is used to encode GTIN attributes, GS1-128 SHOULD encode GTIN as it is best practice to encode the GTIN attributes and the GTIN in a single symbol whenever possible to ensure accurate data association.



Note: Where GS1 DataBar and GS1 DataMatrix are used, GTIN and GTIN attributes SHALL be concatenated to ensure accurate data association.

4. **Scenario-based management practices:** Multiple barcode practices which apply to all sectors are found in section [4.15.1](#) and take precedence over those specific only to healthcare. While industry best practice focuses on using only one barcode per package, a product package that serves multiple markets may have the need for application of multiple barcodes. When this occurrence is unavoidable, the management practices for use of multiple symbols found in figure 4.15.3-1 apply for regulated healthcare trade items. The figure separates solutions based on combinations of scanner environments encountered for each scenario:
 - Scanners encountered combination #1: Package scanned in retail pharmacies (Yes or No).
 - Scanners encountered combination #2: Package scanned in general distribution (Yes or No).

Figure 4.15.3-1. Multiple barcode management practices

Combinations of scanners encountered	Barcode data scenario		Scanner environment		Symbol arrangement	Barcode options	Gen Specs	Proposal
	Symbol 1	Symbol 2	Retail pharmacy or non-retail pharmacy / bedside	Autoated conveyor	Vertical or horizontal		Section	
#1	GTIN A	Only attributes for GTIN A	Y	N	NA	GS1 DataMatrix GS1-128 GS1 DataBar * EAN/UPC plus GS1 DataMatrix, GS1 DataBar Expanded, GS1-128, or * EAN/UPC, GS1 DataBar, or GS1-128 plus ** Composite Component	2.1.2.3 2.1.2.4 4.15.1	See Note 1 See Note 10 For * see Note 2 For ** see Note 3

Combinations of scanners encountered	Barcode data scenario		Scanner environment		Symbol arrangement	Barcode options		Gen Specs	Proposal
	Symbol 1	Symbol 2	Retail pharmacy or non-retail pharmacy / bedside	Autoated conveyor	Vertical or horizontal			Section	
#2	GTIN A	Only attributes for GTIN A	Y	Y	Horizontal	GS1 DataMatrix GS1-128 *EAN/UPC plus GS1 DataMatrix or GS1-128		2.1.2.6 4.15.1	See Note 1 See Note 10 For * see Note 2
#1	GTIN A	GTIN A + GTIN A attributes	Y	N	Depends upon packaging limitations	GS1 DataMatrix GS1-128 GS1 DataBar * EAN/UPC plus GS1 DataMatrix, GS1 DataBar Expanded, GS1-128, or GS1 DataBar, or GS1-128 plus ** Composite Component or * EAN/UPC with ** Composite Component		2.1.2.3 2.1.2.4 4.15.1	See Note 1 See Note 4 See Note 10 For * see Note 6 For ** see Note 3
#2	GTIN A	GTIN A + GTIN A attributes	Y	Y	Depends upon packaging limitations	GS1 DataMatrix GS1-128 *EAN/UPC plus GS1 DataMatrix or GS1-128		2.1.2.6 4.15.1	See Note 1 See Note 2 See Note 4 For * see Note 6 See Note 10
#1	GTIN A + Attribute Set 1	GTIN A + Attribute Set 1	Y	N	Duplicate symbols on bulky packages	GS1 DataMatrix GS1-128 GS1 DataBar Expanded EAN/UPC plus Composite Component	Duplicate of first symbol	2.1.2.3 2.1.2.4	See Note 1 See Note 5 See Note 7 See Note 10
#2	GTIN A + Attribute Set 1	GTIN A + Attribute Set 1	Y	Y	Duplicate symbols on bulky packages	GS1 DataMatrix GS1-128 EAN/UPC plus Composite Component	Duplicate of first symbol	2.1.2.6	See Note 1 See Note 5 See Note 7 See Note 10
#1	GTIN A + Attribute Set 1	GTIN A + Attribute Set 2	Y	N	Depends upon packaging limitations	GS1 DataMatrix GS1-128 GS1 DataBar Expanded EAN/UPC plus Composite Component	GS1 DataMatrix GS1-128 GS1 DataBar Expanded EAN/UPC plus Composite Component	2.1.2.3 2.1.2.4	See Note 1 See Note 5 See Note 8 See Note 10
#2	GTIN A + Attribute Set 1	GTIN A + Attribute Set 2	Y	Y	Horizontal	GS1 DataMatrix GS1-128	GS1 DataMatrix GS1-128	2.1.2.6	See Note 1 See Note 5 See Note 8 See Note 10

Combinations of scanners encountered	Barcode data scenario		Scanner environment		Symbol arrangement	Barcode options		Gen Specs	Proposal
	Symbol 1	Symbol 2	Retail pharmacy or non-retail pharmacy / bedside	Autoated conveyor					
#1	GTIN with serial number	GIAI or GRAI	Not permitted in regulated healthcare on small surgical instruments where only one mark can be made based on the available marking surface and SGTIN is source-marked by brand owner on that surface See Note 10						
#1 or #2	GTIN A	GTIN B	Not permitted						
#2	GTIN A	SSCC	Permitted on trade items which also serve as logistics units. Symbol placement per section 6 (All clauses contained in sections 6.2, 6.4, 6.6, 6.7 and 6.8). See Note 10						
#1	SSCC	AI (02) + AI (37)	Y	N	Vertical	GS1-128	GS1-128	2.2.1	See Note 9
#2	SSCC	AI (02) + AI (37)	Y	Y	Vertical	GS1-128	GS1-128	2.2.1	See Note 9
#1 and #2	GS1 data carried by 1 or 2 symbols	Non-GS1 data	Symbols encoding internal or proprietary data SHOULD not be placed in a location where they could be scanned in the open supply chain (e.g. retail POS, by an automated conveyor line scanner per GS1 specifications) See section 4.15.1 – Obscure placement and Note 10 below						

Notes:

- Note 1: Concatenation of GTIN and GTIN attributes into one symbol is the preferred option for Regulated healthcare retail consumer trade items to validate connectivity between GTIN and attributes. Separating GTIN attributes from the GTIN in the barcode SHOULD be avoided wherever possible as improper association is possible. The scenario takes into account the use of EAN/UPC which is widely used in retail pharmacies to capture GTIN but once a market is prepared to support a data carrier which can encode GTIN plus the GTIN attributes, this data carrier SHOULD replace EAN/UPC when GTIN attributes are required.
- Note 2: Symbols which are not preferred for regulated healthcare retail consumer trade items because they do not allow for concatenation but remain permissible options.
- Note 3: GS1 Composite Component does not stand alone as a complete symbol; it is necessary to associate the composite component with a linear symbol such as EAN/UPC, ITF-14, GS1-128 or GS1 DataBar. GS1 Composite Component therefore remains a legitimate option but only in non-retail applications, GS1 DataMatrix is preferred for regulated healthcare retail consumer trade items based on its ability to encode all information in one symbol and do so efficiently in terms of print speed and panel size.
- Note 4: It is recommended to use only one symbol that encodes the GTIN and attributes.
- Note 5: When two symbols are required to encode a large number of GTIN attributes, both symbols SHOULD be the same symbology and both encode GTIN.
- Note 6: Symbols which are not preferred for regulated healthcare retail consumer trade items because they do not allow for concatenation but remain permissible options.
- Note 7: Recommended for bulky or large trade items or pallets.
- Note 8: Wherever possible use of one symbol to encode GTIN plus all attributes is preferred to encoding attributes in two symbols.
- Note 9: AI (02) + AI (37) not recommended in regulated healthcare supply chain.
- Note 10: Since June 2007 GS1 has recommended all trading partners in the healthcare sector invest exclusively in imaging-based scanners. Now that GS1 DataMatrix has been approved within the standard, it is important to inform all trading partners of a process within GS1 to establish target deployment dates. Without these dates, brand owners do not have a way to know when to deploy GS1 DataMatrix on their packaging and those needing to invest in scanning equipment may inadvertently purchase equipment that will not support the standards. To see GS1 healthcare's position paper on GS1 DataMatrix adoption, visit <http://www.gs1.org/healthcare>.

5 Data carriers

5.1	Introduction.....	212
5.2	Linear barcodes - EAN/UPC symbology specifications.....	216
5.3	Linear barcodes - ITF-14 symbology specifications.....	237
5.4	Linear barcodes - GS1-128 symbology specifications.....	244
5.5	Barcode production and quality assessment	259
5.6	Linear barcodes – GS1 DataBar	305
5.7	Two dimensional barcodes – GS1 DataMatrix symbology	317
5.8	Composite barcodes	323
5.9	Two dimensional barcodes – GS1 QR Code symbology	334
5.10	Appendix: Rules for encoding/decoding element strings in GS1 symbologies using GS1 Application Identifiers.....	341

5.1 Introduction

A data carrier is a means of representing data in machine readable form. Data carriers that are endorsed by GS1 are described in sections [5.1](#), [5.2](#), [5.3](#), [5.4](#), [5.6](#), [5.7](#), [5.8](#), [5.9](#); barcode production and quality assessment are covered in section [5.5](#).

The GS1 system specifies the data carrier used to represent any given element string. Section 2 covers rules indicating which data carrier should be used to represent which element strings in particular applications. The GS1 system uses the following data carriers:

- The EAN/UPC symbology family of barcodes (UPC-A, UPC-E, EAN-13, and EAN-8 barcodes and the two- and five-digit add-on symbols) can be read omnidirectionally. These symbols must be used for all items that are scanned at the point-of-sale and may be used on other trade items.

Figure 5.1-1. UPC-A and EAN-13 barcodes



- ITF-14 (Interleaved 2-of-5) barcodes carry ID numbers only on trade items that are not expected to pass through the point-of-sale. ITF-14 symbols are better suited for direct printing onto corrugated fibreboard.

Figure 5.1-2. ITF-14 barcode

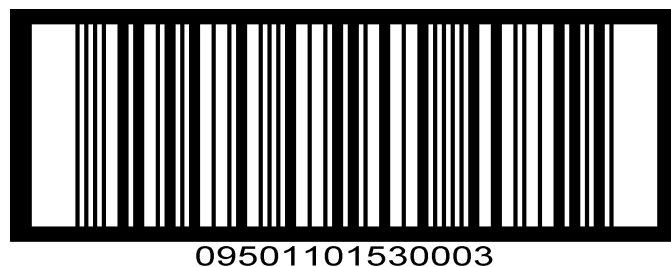

- The GS1-128 barcode is a subset of the Code 128 barcode symbology. Its use is exclusively licenced to GS1. This extremely flexible symbology encodes element strings using GS1 Application Identifiers.

Figure 5.1-3. GS1-128 barcode



- GS1 DataBar is a family of linear symbologies used within the GS1 system. This family of linear symbologies in most cases implicitly encodes GS1 Application Identifier (01) and in the case of GS1 DataBar Expanded explicitly encodes element strings using GS1 Application Identifiers.

Figure 5.1-4. GS1 DataBar Omnidirectional barcode

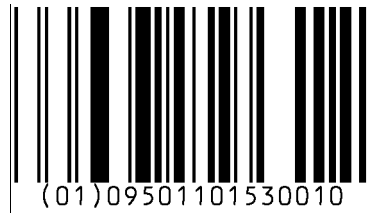

- Composite Component symbols do not exist in isolation. The primary identification number is always encoded in the linear symbol and supplementary GS1 Application Identifier element strings are encoded in the two-dimensional (2D) component where they take up less space.

Figure 5.1-5. GS1 DataBar Stacked Omnidirectional barcode with a Composite Component



- Data Matrix ISO version ECC 200 is the only version that supports GS1 system data structures, including Function 1 Symbol Character (FNC1). Implementation of GS1 DataMatrix SHALL be done per approved GS1 system application standards, such as those for regulated healthcare retail consumer trade items.

Figure 5.1-6. GS1 DataMatrix barcode



- GS1 QR Code, is a subset of *ISO/IEC 18004:2015*. QR Code supports GS1 system data structures, including Function 1 Symbol Character (FNC1). Implementation of GS1 QR Code SHALL be done per approved GS1 system application standards.

Figure 5.1-7. GS1 QR Code barcode



5.1.1 International standards

A number of national and regional standardisation bodies have developed barcode technical standards. The International Organisation for Standardisation (ISO) has published standard barcode symbology specifications via a subcommittee of ISO/IEC JTC1 (International Organisation for Standardisation/International Electrotechnical Commission Joint Technical Committee 1).

GS1 is actively involved in developing these standards. The objective is for GS1 system standards to remain fully compatible with relevant published national, regional, and international symbology standards. The pertinent documents for section 5 include the latest published version of:

- **Section 5.1:** *ISO/IEC 15424: Information technology; automatic identification and data capture techniques; data carrier/symbology identifiers.*
- **Section 5.2:** *ISO/IEC 15420: Information technology; automatic identification and data capture techniques; bar code symbology specifications; EAN/UPC.*
- **Section 5.3:** *ISO/IEC 16390: Information technology; automatic identification and data capture techniques; bar code symbology specifications; ITF-14.*
- **Section 5.4:** *ISO/IEC 15417: Information technology; automatic identification and data capture techniques; bar code symbology specifications; GS1-128 Symbology specifications.*
- **Section 5.5:** Bar Code Production and Quality Assessment:
 - *ISO/IEC 15415: Information technology; automatic identification and data capture techniques; bar code print quality test specification; two-dimensional symbols.*
 - *ISO/IEC 15416: Information technology; automatic identification and data capture techniques; bar code print quality test specification; linear symbols.*
 - *ISO/IEC 15419: Information technology; automatic identification and data capture techniques; bar code digital imaging and printing performance testing.*
 - *ISO/IEC 15421: Information technology; automatic identification and data capture techniques; bar code master test specifications.*
 - *ISO/IEC 15426-1: Information technology; automatic identification and data capture techniques; bar code verifier conformance specification - Part 1: Linear symbols.*
 - *ISO/IEC 15426-2: Information technology; automatic identification and data capture techniques; bar code verifier conformance specification - Part 2: Two-dimensional symbols.*
 - *ISO 1073-2: Alphanumeric character sets for optical recognition – Part 2: Character set OCR-B Shapes and dimensions of the printed image.*
 - *ISO/IEC TR 29158: Information technology; Automatic identification and data capture techniques; direct part marking (DPM) Quality Guideline.*
- **Section 5.6:** *ISO/IEC 24724: Information technology; automatic identification and data capture techniques; GS1 DataBar bar code symbology specification.*
- **Section 5.7:** *ISO/IEC 16022: Information technology; automatic identification and data capture techniques; Data Matrix bar code symbology specification.*
- **Section 5.8:** *ISO/IEC 24723: Information technology; automatic identification and data capture techniques; EAN.UCC Composite bar code symbology specification.*
- **Section 5.9:** *ISO/IEC 18004:2015: Information technology; automatic identification and data capture techniques; QR Code bar code symbology specification.*
- **All sections:** *ISO/IEC 646: Information technology; ISO 7-bit coded character set for information interchange.*

5.1.2 Symbology identifiers

The symbology identifier is not encoded in the barcode, but is generated by the decoder after decoding and is transmitted as a preamble to the data message.

All scanning equipment has the ability to recognise the symbology that has been scanned. Some scanners have the optional feature of being able to transmit a symbology identifier. The symbology identifier is a three-character data string comprising a flag character, code character, and a modifier character. The symbology identifiers used in the GS1 system are shown in figure 5.1.2-1.

Figure 5.1.2-1. Structure of the symbology identifiers

Character	Description
] 	The flag character (which has an ASCII value of 93). This denotes that the two characters following it are Symbol Identifier characters.
c	The code character. This denotes the type of symbology.
m	The modifier character. This indicates the mode in which the symbology is used.



Note: If used, the symbology identifier is transmitted as a prefix to the data message.

Figure 5.1.2-2. ISO/IEC 15424 symbology identifiers used in the GS1 system

Symbology identifier (*)	Symbology format	Content
]E0	EAN-13, UPC-A, or UPC-E	13 digits
]E1	Two-digit add-on symbol	2 digits
]E2	Five-digit add-on symbol	5 digits
]E3	EAN-13, UPC-A, or UPC-E with add-on symbol (**)	15 or 18 digits
]E4	EAN-8	8 digits
]I1	ITF-14	14 digits
]C1	GS1-128	Standard AI element strings
]e0	GS1 DataBar	Standard AI element strings
]e1	GS1 Composite	Data packet containing the data following an encoded symbol separator character.
]e2	GS1 Composite	Data packet containing the data following an escape mechanism character.
]d2	GS1 DataMatrix	Standard AI element strings
]Q3	GS1 QR Code	Standard AI element strings

(*) Symbology identifiers are case sensitive.

(**) Barcodes with add-on symbols may be considered either as two separate symbols, each of which is transmitted separately with its own symbology identifier, or as a single data packet. The system designer SHALL select one of these methods, but the method using symbology identifier]E3 is preferable for data security.

5.2 Linear barcodes - EAN/UPC symbology specifications

5.2.1 Symbology characteristics

Characteristics of barcodes in the EAN/UPC symbology family include:

- Encodable character set: digits (0 through 9) in accordance with *ISO/IEC 646*: Refer to [Figure 7.11-1](#) for more details.
- Symbology type: continuous.
- Symbol character density: seven modules per symbol character.
- Four elements per symbol character comprising two bars (dark bars) and two spaces (light bars), each of one, two, three, or four modules in width (auxiliary guard patterns have differing numbers of elements).
- Character self-checking.
- Fixed data string length encodable: 8, 12, or 13 characters including check digit, depending on specific symbol type.
- Omni-directionally decodable.
- One mandatory check digit (described in section [7.9](#)).
- Non-data overhead not including the check digit or Quiet Zones:
 - 11 modules for EAN-13, EAN-8, and UPC-A barcodes (left guard bar pattern/centre guard bar pattern/right guard bar pattern).
 - Nine modules for UPC-E barcodes (left guard bar pattern/right guard bar pattern).

5.2.1.1 Symbol types

The barcodes in the EAN/UPC symbology family are:

- EAN-13, UPC-A, and UPC-E barcodes, all of which may be accompanied by an add-on symbol.
- EAN-8 barcode.

The four symbol types are described in sections [5.2.1.3.1](#), [5.2.1.3.2](#), [5.2.1.3.3](#), and [5.2.1.3.4](#), and the optional add-on symbols are described in section [5.2.1.3.5](#).

5.2.1.2 Symbol encodation

5.2.1.2.1 Symbol character encodation

Symbol characters SHALL encode digit values in seven module characters selected from different number sets known as A, B, and C as shown in the figure below.

Figure 5.2.1.2.1-1. Number sets A, B, and C

Digit value	Set A element widths				Set B element widths				Set C element widths			
	S	B	S	B	S	B	S	B	B	S	B	S
0	3	2	1	1	1	1	2	3	3	2	1	1
1	2	2	2	1	1	2	2	2	2	2	2	1
2	2	1	2	2	2	2	1	2	2	1	2	2
3	1	4	1	1	1	1	4	1	1	4	1	1
4	1	1	3	2	2	3	1	1	1	1	3	2
5	1	2	3	1	1	3	2	1	1	2	3	1
6	1	1	1	4	4	1	1	1	1	1	1	4
7	1	3	1	2	2	1	3	1	1	3	1	2
8	1	2	1	3	3	1	2	1	1	2	1	3
9	3	1	1	2	2	1	1	3	3	1	1	2

S denotes a space (light bar), **B** denotes a bar (dark bar), and the element widths are in modules.

Figure 5.2.4.1-1 graphically illustrates figure 5.2.1.2.1-1. The sum of the bar (dark bar) modules in any symbol character determines its parity. Symbol characters in number set A are odd parity characters. Symbol characters in number sets B and C are even parity characters. Number set C characters are mirror images of number set B characters.

Symbol characters in number sets A and B always begin on the left with a space module and end on the right with a dark module. Symbol characters in number set C begin on the left with a dark module and end on the right with a light module.

A data character shall normally be represented by a symbol character. However, in certain specific instances defined in sections [5.2.1.3.1](#), [5.2.1.3.4](#), and [5.2.1.3.5](#), the combination of number sets in a symbol may itself represent either data or a check digit value. This technique is referred to as variable parity encodation.

5.2.1.2.2 Auxiliary pattern encodation

Auxiliary patterns SHALL be composed as shown in figure 5.2.1.2.2-1.

Figure 5.2.1.2.2-1. Auxiliary patterns

Auxiliary pattern	Number of modules	Element widths in modules					
		S	B	S	B	S	B
Normal guard bar pattern	3		1	1	1		
Centre guard bar pattern	5	1	1	1	1	1	
Special guard bar pattern	6	1	1	1	1	1	1
Add-on guard bar pattern	4		1	1	2		
Add-on delineator	2	1	1				

S denotes a space (light) element and **B** denotes a bar (dark) element.

Section [5.2.4.2](#) graphically illustrates these patterns.

The normal guard bar pattern corresponds to the start and stop patterns in other symbologies, and the special guard bar pattern is used as a stop pattern in UPC-E barcodes.

5.2.1.3 Symbol formats

5.2.1.3.1 EAN-13 barcodes

The EAN-13 barcode SHALL be made up as follows, reading from left to right:

- A left Quiet Zone.
- A normal guard bar pattern.
- Six symbol characters from number sets A and B.
- A centre guard bar pattern.
- Six symbol characters from number set C.
- A normal guard bar pattern.
- A right Quiet Zone.

The rightmost symbol character SHALL encode the check digit calculated in accordance with section [7.9](#).

Since the EAN-13 barcode comprises only 12 symbol characters but encodes 13 digits of data (including the check digit), the value of the additional digit, which is the character in the leftmost position in the data string, SHALL be encoded by the variable parity mix of number sets A and B for the six symbol characters in the left half of the symbol. The numbering system for values of the leading digit is specified in figure 5.2.1.3.1-1. Figure 5.2.1.3.1-2 is an example of an EAN-13 barcode.

Figure 5.2.1.3.1-1. Left half of an EAN-13 barcode

Leading digit, implicitly encoded	Number sets used for numbering left half of an EAN-13 barcode					
	Symbol character position					
	1	2	3	4	5	6
0*	A	A	A	A	A	A
1	A	A	B	A	B	B
2	A	A	B	B	A	B
3	A	A	B	B	B	A
4	A	B	A	A	B	B
5	A	B	B	A	A	B
6	A	B	B	B	A	A
7	A	B	A	B	A	B
8	A	B	A	B	B	A
9	A	B	B	A	B	A

* The leading digit value "0" is reserved for symbols encoding GTIN-12 element strings.

Figure 5.2.1.3.1-2. EAN-13 barcode

5.2.1.3.2 EAN-8 barcodes

The EAN-8 barcode SHALL be made up as follows, reading from left to right:

- A left Quiet Zone.
- A normal guard bar pattern.
- Four symbol characters from number set A.
- A centre guard bar pattern.
- Four symbol characters from number set C.
- A normal guard bar pattern.
- A right Quiet Zone.

The rightmost symbol character SHALL encode the check digit calculated in accordance with section [7.9](#). Figure 5.2.1.3.2-1 is an example of an EAN-8 barcode.

Figure 5.2.1.3.2-1. EAN-8 barcode

5.2.1.3.3 UPC-A barcodes

The UPC-A barcode SHALL be made up as follows, reading from left to right:

- A left Quiet Zone.

- A normal guard bar pattern.
- Six symbol characters from number set A.
- A centre guard bar pattern.
- Six symbol characters from number set C.
- A normal guard bar pattern.
- A right Quiet Zone.

The rightmost symbol character SHALL encode the check digit calculated in accordance with section [7.9](#). A UPC-A barcode may be decoded as a 13-digit number by adding an implied leading zero to the GTIN-12. Figure 5.2.1.3.3-1 is an example of a UPC-A barcode.

Figure 5.2.1.3.3-1. UPC-A barcode



5.2.1.3.4 UPC-E barcodes

The UPC-E barcode SHALL be made up as follows, reading from left to right:

- A left Quiet Zone.
- A normal guard bar pattern.
- Six symbol characters from number sets A and B.
- A special guard bar pattern.
- A right Quiet Zone.

The UPC-E barcode may only be used to encode GTIN-12 element strings that commence with a zero and contain a sequence of four or five zeroes in defined positions, as shown in figure 5.2.2.3.4-1. These zeros are removed from the data during encoding by the zero-suppression process described in section [5.2.1.3.4.1](#). Figure 5.2.1.3.4-1 is an example of a UPC-E barcode.

Figure 5.2.1.3.4-1. UPC-E barcode (encoding 001234000057 by zero-suppression)

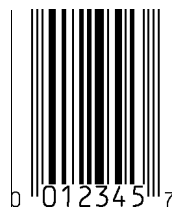

5.2.1.3.4.1 Encodation of the UPC-E barcode

The following algorithm describes the encodation of a data string suitable for zero-suppression:

- Let D1, D2, and D3 through D12 denote the GTIN-12 data characters (including check digit). D1 SHALL always be zero. D12 SHALL be the check digit calculated according to the algorithm in section [7.9](#). Let X1 and X2 through X6 denote the six symbol characters in the final UPC-E barcode. Convert D2 through D11 into a symbol character string by removing zeroes according to the following rules:

If	Then
<ul style="list-style-type: none"> ■ D11 equals 5, 6, 7, 8, or 9 ■ and D7 to D10 inclusive are all 0 ■ and D6 is not 0 	<ul style="list-style-type: none"> ■ D7 to D10 are not encoded. ■ Symbol character: X1 X2 X3 X4 X5 X6 ■ Data character: D2 D3 D4 D5 D6 D11
If	Then
<ul style="list-style-type: none"> ■ D6 to D10 inclusive are all 0 ■ and D5 is not 0 	<ul style="list-style-type: none"> ■ D6 to D10 are not encoded and X6 = 4. ■ Symbol character: X1 X2 X3 X4 X5 X6 ■ Data character: D2 D3 D4 D5 D11 4
If	Then
<ul style="list-style-type: none"> ■ D4 is 0, 1, or 2 ■ and D5 to D8 inclusive are all 0 	<ul style="list-style-type: none"> ■ D5 to D8 are not encoded. ■ Symbol character: X1 X2 X3 X4 X5 X6 ■ Data character: D2 D3 D9 D10 D11 D4
If	Then
<ul style="list-style-type: none"> ■ D4 is 3, 4, 5, 6, 7, 8, or 9 ■ and D5 to D9 inclusive are all 0 	<ul style="list-style-type: none"> ■ D5 to D9 are not encoded and X6 = 3. ■ Symbol character: X1 X2 X3 X4 X5 X6 ■ Data character: D2 D3 D4 D10 D11 3

Determine the number sets for the implicit encoding of D12 from figure 5.2.1.3.4.1-1
 Encode symbol characters X1 to X6 using number sets A and B as determined in Step 3.

Figure 5.2.1.3.4.1-1. Number sets for implicit encoding of D12

Value of check digit D12	Number sets used for numbering a UPC-E barcode					
	Symbol Character Position					
	1	2	3	4	5	6
0	B	B	B	A	A	A
1	B	B	A	B	A	A
2	B	B	A	A	B	A
3	B	B	A	A	A	B
4	B	A	B	B	A	A
5	B	A	A	B	B	A
6	B	A	A	A	B	B
7	B	A	B	A	B	A
8	B	A	B	A	A	B
9	B	A	A	B	A	B

Figure 5.2.1.3.4.1-2. Zero suppression example 1

Example 1	Original data	Zero-suppressed	Rule
	0 1 2 3 4 5 0 0 0 0 5 8	1 2 3 4 5 5	2a
		B A B A A B	

Figure 5.2.1.3.4.1-3. Zero suppression example 2

Example 2	Original data	Zero-suppressed	Rule
	0 4 5 6 7 0 0 0 0 0 8 0	4 5 6 7 8 4	2b
		B B B A A A	

Figure 5.2.1.3.4.1-4. Zero suppression example 3

Example 3	Original data	Zero-suppressed	Rule
	0 3 4 0 0 0 0 5 6 7 3	3 4 5 6 7 0	2c
		B B A A A B	

Figure 5.2.1.3.4.1-5. Zero suppression example 4

Example 4	Original data	Zero-suppressed	Rule
	0 9 8 4 0 0 0 0 7 5 1	9 8 4 7 5 3	2d
		B B A B A A	



Note: The number sets used to implicitly encode the check digit are shown in the zero-suppressed column.

5.2.1.3.4.2 Decoding a UPC-E barcode

Derivation of the 12-digit data string from the characters encoded in the UPC-E barcode SHALL be performed according to figure 5.2.1.3.4.2-1.

Figure 5.2.1.3.4.2-1. Decoding a UPC-E barcode

Encoded UPC-E barcode digits								Decoded number											
	P1	P2	P3	P4	P5	P6		D1	D2	D3	D4	D5	D6	D7	D8	D9	D10	D11	D12
(0)	X1	X2	X3	X4	X5	0	(C)	(0)	X1	X2	0	<u>0</u>	<u>0</u>	<u>0</u>	<u>0</u>	X3	X4	X5	(C)
(0)	X1	X2	X3	X4	X5	1	(C)	(0)	X1	X2	1	<u>0</u>	<u>0</u>	<u>0</u>	<u>0</u>	X3	X4	X5	(C)
(0)	X1	X2	X3	X4	X5	2	(C)	(0)	X1	X2	2	<u>0</u>	<u>0</u>	<u>0</u>	<u>0</u>	X3	X4	X5	(C)
(0)	X1	X2	X3	X4	X5	3	(C)	(0)	X1	X2	X3	<u>0</u>	<u>0</u>	<u>0</u>	<u>0</u>	<u>0</u>	X4	X5	(C)
(0)	X1	X2	X3	X4	X5	4	(C)	(0)	X1	X2	X3	X4	<u>0</u>	<u>0</u>	<u>0</u>	<u>0</u>	<u>0</u>	X5	(C)
(0)	X1	X2	X3	X4	X5	5	(C)	(0)	X1	X2	X3	X4	X5	<u>0</u>	<u>0</u>	<u>0</u>	<u>0</u>	5	(C)
(0)	X1	X2	X3	X4	X5	6	(C)	(0)	X1	X2	X3	X4	X5	<u>0</u>	<u>0</u>	<u>0</u>	<u>0</u>	6	(C)
(0)	X1	X2	X3	X4	X5	7	(C)	(0)	X1	X2	X3	X4	X5	<u>0</u>	<u>0</u>	<u>0</u>	<u>0</u>	7	(C)
(0)	X1	X2	X3	X4	X5	8	(C)	(0)	X1	X2	X3	X4	X5	<u>0</u>	<u>0</u>	<u>0</u>	<u>0</u>	8	(C)
(0)	X1	X2	X3	X4	X5	9	(C)	(0)	X1	X2	X3	X4	X5	<u>0</u>	<u>0</u>	<u>0</u>	<u>0</u>	9	(C)

Notes:

- The symbol characters at positions P1 and P2 through P5 of the UPC-E barcode are represented by X1 and X2 through X5.
- Re-inserted zeroes are indicated by underlining.
- The leading digit for UPC-E barcodes, which is not encoded, is indicated by "0".
- The check digit implicitly encoded in UPC-E barcodes is indicated by "C".

5.2.1.3.5 Add-on symbols

The add-on symbols were designed to encode information supplementary to that in the main barcode on periodicals, hardback, and paperback books. Because they provide reduced security, use of add-on symbols SHALL be limited to applications where rules in the application specification governing data format and content provide appropriate safeguards.

5.2.1.3.5.1 Two-digit add-on symbol

A two-digit add-on symbol may be used in specific applications to accompany an EAN-13, UPC-A, or UPC-E barcode. The two-digit add-on symbol is positioned following the right Quiet Zone of the main symbol and consists of the following:

- Add-on guard bar pattern.
- First digit of the additional number from number sets A or B.
- Add-on delineator.
- Second digit of the additional number from number sets A or B.
- A right Quiet Zone.

The add-on symbol has no right guard bar pattern. It does not have an explicit check digit. Checking is done through the mix of the number sets (A or B) used for the two digits. The choice of number sets is linked to the value of the additional number as shown by figure 5.2.1.3.5.1-1.

Figure 5.2.1.3.5.1-1. Number sets for five-digit add-on symbols

Value of the digits carried by the add-on symbol	Left-hand digit	Right-hand digit
Multiple of 4 (00,04,08,..96)	A	A
Multiple of 4+1 (01,05,..97)	A	B
Multiple of 4+2 (02,06,..98)	B	A
Multiple of 4+3 (03,07,..99)	B	B

Figure 5.2.1.3.5.1-2 is an example of an EAN-13 barcode with a two-digit add-on symbol.

Figure 5.2.1.3.5.1-2. EAN-13 barcode with two-digit add-on symbol



5.2.1.3.5.2 Five-digit add-on symbol

A five-digit add-on symbol may be used in specific applications to accompany an EAN-13, UPC-A, or UPC-E barcode. The five-digit add-on symbol is positioned following the right Quiet Zone of the main symbol and consists of the following:

1. Add-on guard bar pattern.
2. First digit of the add-on number from number sets A or B.
3. Add-on delineator.
4. Second digit of the add-on number from number sets A or B.
5. Add-on delineator.
6. Third digit of the add-on number from number sets A or B.
7. Add-on delineator.
8. Fourth digit of the add-on number from number sets A or B.
9. Add-on delineator.
10. Fifth digit of the add-on number from number sets A or B.
11. A right Quiet Zone.

The add-on symbol has no right guard bar pattern. It does not have an explicit check digit. Checking is done through the mix of the number sets (A or B) used for the five digits. A value V is determined by the following procedure:

1. Sum the digits in Positions one, three, and five.

2. Multiply the result of step 1 by 3.
3. Sum the remaining digits (Positions two and four).
4. Multiply the result of step 3 by 9.
5. Sum the results of steps 2 and 4.
6. The value of V is the unit's position (lowest-order digit) of the result of step.

Example:

To calculate the value of V for an add-on symbol carrying the number 86104, follow these steps:

1. $8 + 1 + 4 = 13$
2. $13 \times 3 = 39$
3. $6 + 0 = 6$
4. $6 \times 9 = 54$
5. $39 + 54 = 93$
6. $V = 3$

The number sets can then be determined by using figure 5.2.1.3.5.2-1.

Figure 5.2.1.3.5.2-1. Number sets for five-digit add-on symbol

Value of V	Number sets used for symbol characters				
	1	2	3	4	5
0	B	B	A	A	A
1	B	A	B	A	A
2	B	A	A	B	A
3	B	A	A	A	B
4	A	B	B	A	A
5	A	A	B	B	A
6	A	A	A	B	B
7	A	B	A	B	A
8	A	B	A	A	B
9	A	A	B	A	B

Since $V = 3$ in figure 5.2.1.3.5.2-1, the sequence of number sets used to encode the value 86104 is B A A A B.

Figure 5.2.1.3.5.2-2 shows an example of an EAN-13 barcode with a five-digit add-on symbol.

Figure 5.2.1.3.5.2-2. EAN-13 barcode with five-digit add-on symbol



5.2.1.4 Dimensions and tolerances

5.2.1.4.1 Nominal dimensions of characters

Barcodes can be printed at various densities to accommodate a variety of printing and scanning processes. The significant dimensional parameter is **X**, the ideal width of a single module element. The X-dimension must be constant throughout a given symbol.

The dimensions of EAN-13, UPC-A, EAN-8 and UPC-E barcodes are referenced to a defined set of dimensions referred to as the nominal size symbol. Refer to section [5.2.4.6](#) for dimensioned drawings of nominal size symbols.

The X-dimension at nominal size is 0.330 millimetre (0.0130 inch).

The width of each bar (dark bar) and space (light bar) is determined by multiplying the X-dimension by the module width of each bar (dark bar) and space (light bar) (1, 2, 3, or 4). There is an exception for characters 1, 2, 7, and 8. For these characters, the bars (dark bars) and spaces (light bars) are reduced or enlarged by one-thirteenth of a module to provide a uniform distribution of bar width tolerances and thus improve scanning reliability.

The reduction or enlargement in millimetres at nominal size of the bars (dark bars) and spaces (light bars) for the characters 1, 2, 7, and 8 in the number sets A, B, and C is shown in figure 5.2.1.4.1-1.

Figure 5.2.1.4.1-1. Reduction/enlargement for characters 1, 2, 7, and 8

Character value	Number set A		Number sets B and C	
	Bar (dark bar) mm	Space (light bar) mm	Bar (dark bar) mm	Space (light bar) mm
1	- 0.025	+0.025	+0.025	- 0.025
2	- 0.025	+0.025	+0.025	- 0.025
7	+0.025	- 0.025	- 0.025	+0.025
8	+0.025	- 0.025	- 0.025	+0.025



Note: The existing symbol generation equipment that uses a value of 0.030 millimetre for the reduction/enlargement factor at nominal size will continue to be used for the foreseeable future.

5.2.1.4.2 Symbol height

For EAN-13, UPC-A, and UPC-E barcodes the height of the symbol at the nominal size is 22.85 millimetres (0.900 inch). For EAN-8 barcodes the height of the symbol at the nominal size is 18.23 millimetres (0.718 inch).

The height of any two-digit or five-digit add-on symbol used must not extend outside the symbol height dimensions of the primary symbol.

In EAN-13, EAN-8, UPC-A, and UPC-E barcodes, the bars (dark bars) forming the left, centre, and right guard bar patterns SHALL be extended downward by 5x (e.g., 1.65 millimetres (0.065 inch)). This SHALL also apply to the bars (dark bars) of the first and last symbol characters of the UPC-A barcode.



Note: The height of an EAN/UPC barcode no longer includes the human readable interpretation and is the height of the bars only. The measurement of bar height does not include the extended height of either the guard patterns in EAN/UPC barcodes or the first and last symbol characters of a UPC-A barcode.

Symbol height is not modular.

5.2.1.4.3 X-dimension (magnification factor)

In the past the term "magnification factor" was extensively used to specify the size of a barcode. This technique relied upon setting a nominal size (100 percent) that was directly related to a given

X-dimension. Since January 2000, the more precise term “X-dimension” has been used to specify permissible symbol sizes (see section 5.5). The X-dimension of an add-on symbol SHALL be the same as the X-dimension of its associated main symbol.

5.2.1.4.4 Quiet Zone

The minimum Quiet Zone width required by the main barcode is 7x. However, other minimum Quiet Zone dimensions are specified for some symbol types due to the size and location of their human readable interpretation. These dimensions are noted in figure 5.2.1.4.4-1.

Figure 5.2.1.4.4-1. Quiet Zone widths by version

Symbol version	Left Quiet Zone		Right Quiet Zone	
	Modules	mm*	Modules	mm
EAN-13	11	3.63	7	2.31
EAN-8	7	2.31	7	2.31
UPC-A	9	2.97	9	2.97
UPC-E	9	2.97	7	2.31
Add-ons (EAN)	7-12	2.31-3.96	5	1.65
Add-ons (U.P.C.)	9-12	2.97-3.96	5	1.65

* This is an example using an X-dimension of 0.330 millimetres.



Note: A useful device to help maintain the Quiet Zone in some production processes is to include a less than (<) and/or greater than (>) character in the human readable interpretation field, with its apex aligned with the edge of the Quiet Zone. If this device is used, the character(s) SHALL be positioned in accordance with the appropriate drawings in section 5.2.4.6.

5.2.1.4.5 Symbol length

The symbol length in modules, including the minimum Quiet Zones, SHALL be as indicated in the figure below.

Figure 5.2.1.4.5-1. Symbol length in modules

Symbol type	Length
EAN-13	113
UPC-A	113
EAN-8	81
UPC-E	67
Two-digit add-on	25
Five-digit add-on	52
EAN-13 or UPC-A and two-digit add-on	138
UPC-E and two-digit add-on	92
EAN-13 or UPC-A and five-digit add-on	165
UPC-E and five-digit add-on	119

5.2.1.4.6 Positioning of the add-on symbol

The add-on symbol SHALL NOT encroach on the right Quiet Zone of the main symbol. The maximum separation SHALL be 12X. The bottom edge of the bars (dark bars) in the add-on symbol SHALL be horizontally aligned with the bottom edge of the guard bars of the main symbol.

5.2.2 Reference decode algorithm

Decode algorithms are used by scanning equipment to convert the bar and space patterns of the barcode into data characters. As a matter of policy, GS1 makes no attempt to specify or standardise equipment beyond stating that it should be capable of reading symbols produced in accordance with the specifications laid out in this manual.

Barcode reader systems are designed to read imperfect symbols to the extent that practical algorithms permit. This section describes the reference decode algorithm used to determine decode and decodability in symbol verification in accordance with *ISO 15416*.

For each symbol character, let S equal the total measured width of the character. The value S is used to determine reference threshold (RT) values. Individual edge to similar edge measurements (e) are then compared to the reference threshold to determine E values. Character values are determined from E values.

Value e_1 is defined as the measurement from the leading edge of a bar (dark bar) to the leading edge of the adjacent bar (dark bar). Value e_2 is defined as the measurement from the trailing edge of a bar (dark bar) to the trailing edge of the adjacent bar (dark bar). For number sets A and B, the right edge of each of the two bars (dark bars) is considered to be leading, while for number set C, the left edge of each bar (dark bar) is considered to be leading. These relationships are illustrated in the figure below.

Figure 5.2.2-1. Symbol character decode measurements

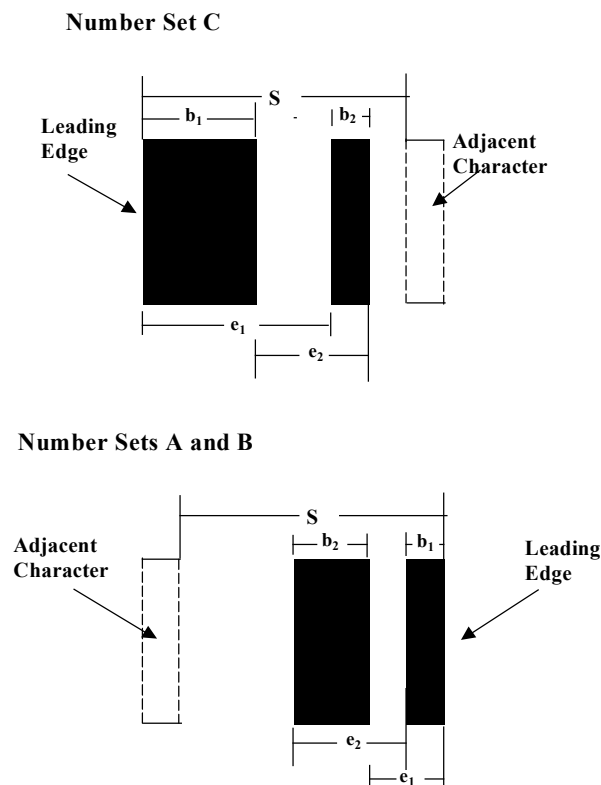

Reference thresholds RT_1 , RT_2 , RT_3 , RT_4 , and RT_5 are given by:

- $RT_1 = (1.5/7)S$
- $RT_2 = (2.5/7)S$
- $RT_3 = (3.5/7)S$
- $RT_4 = (4.5/7)S$
- $RT_5 = (5.5/7)S$

Within each character, the measurements e_1 and e_2 are compared with the reference thresholds. The corresponding integer values E_1 and E_2 are considered to be equal to 2, 3, 4, or 5 as follows:

- If $RT_1 \leq e_i < RT_2$, $E_i = 2$
- If $RT_2 \leq e_i < RT_3$, $E_i = 3$
- If $RT_3 \leq e_i < RT_4$, $E_i = 4$
- If $RT_4 \leq e_i < RT_5$, $E_i = 5$

Otherwise the character is in error.

Figure 5.2.2-2, use the values of E_1 and E_2 as the primary determinant for the symbol character value.

Figure 5.2.2-2. Barcode decoding

Character	Number set	Primary determinant		Secondary determinant $7(b_1 + b_2)/S$
		E_1	E_2	
0	A	2	3	
1	A	3	4	≤ 4
2	A	4	3	≤ 4
3	A	2	5	
4	A	5	4	
5	A	4	5	
6	A	5	2	
7	A	3	4	> 4
8	A	4	3	> 4
9	A	3	2	
0	B and C	5	3	
1	B and C	4	4	> 3
2	B and C	3	3	> 3
3	B and C	5	5	
4	B and C	2	4	
5	B and C	3	5	
6	B and C	2	2	
7	B and C	4	4	≤ 3
8	B and C	3	3	≤ 3
9	B and C	4	2	

b_1 and b_2 are the widths of the two bar (dark bar) elements

The character is uniquely determined for all combinations of E_1 and E_2 except for the following four cases:

- $E_1 = 3$ and $E_2 = 4$ (characters 1 and 7 in number set A).
- $E_1 = 4$ and $E_2 = 3$ (characters 2 and 8 in number set A).
- $E_1 = 4$ and $E_2 = 4$ (characters 1 and 7 in number sets B and C).
- $E_1 = 3$ and $E_2 = 3$ (characters 2 and 8 in number sets B and C).

These cases require that the combined width of the two bars (dark bars) be tested as follows:

- For $E_1 = 3$ and $E_2 = 4$:
 - Character is 1 if $7 \times (b_1 + b_2) / S \leq 4$
 - Character is 7 if $7 \times (b_1 + b_2) / S > 4$
- For $E_1 = 4$ and $E_2 = 3$:

- Character is 2 if $7 \times (b1 + b2) / S \leq 4$
- Character is 8 if $7 \times (b1 + b2) / S > 4$
- For $E1 = 4$ and $E2 = 4$:
 - Character is 1 if $7 \times (b1 + b2) / S > 3$
 - Character is 7 if $7 \times (b1 + b2) / S \leq 3$
- For $E1 = 3$ and $E2 = 3$:
 - Character is 2 if $7 \times (b1 + b2) / S > 3$
 - Character is 8 if $7 \times (b1 + b2) / S \leq 3$

The requirements on $(b1 + b2)$ are shown in figure 5.2.2-2.

The same procedures SHALL be used to decode the symbol characters in any add-on symbol.

Use the figure below to determine the appropriate S measurement for calculating the reference threshold values $RT1$ and $RT2$ applicable to the auxiliary patterns of the main symbol. For each symbol or half symbol, the measurements of the appropriate auxiliary pattern e_i values are then compared to the reference thresholds to establish the integer E_i values. The determined values of $E1$, $E2$, $E3$, and $E4$ SHALL match those of valid auxiliary patterns as shown figure 5.2.2-4. Otherwise the symbol is in error.

Figure 5.2.2-3. Auxiliary pattern measurements

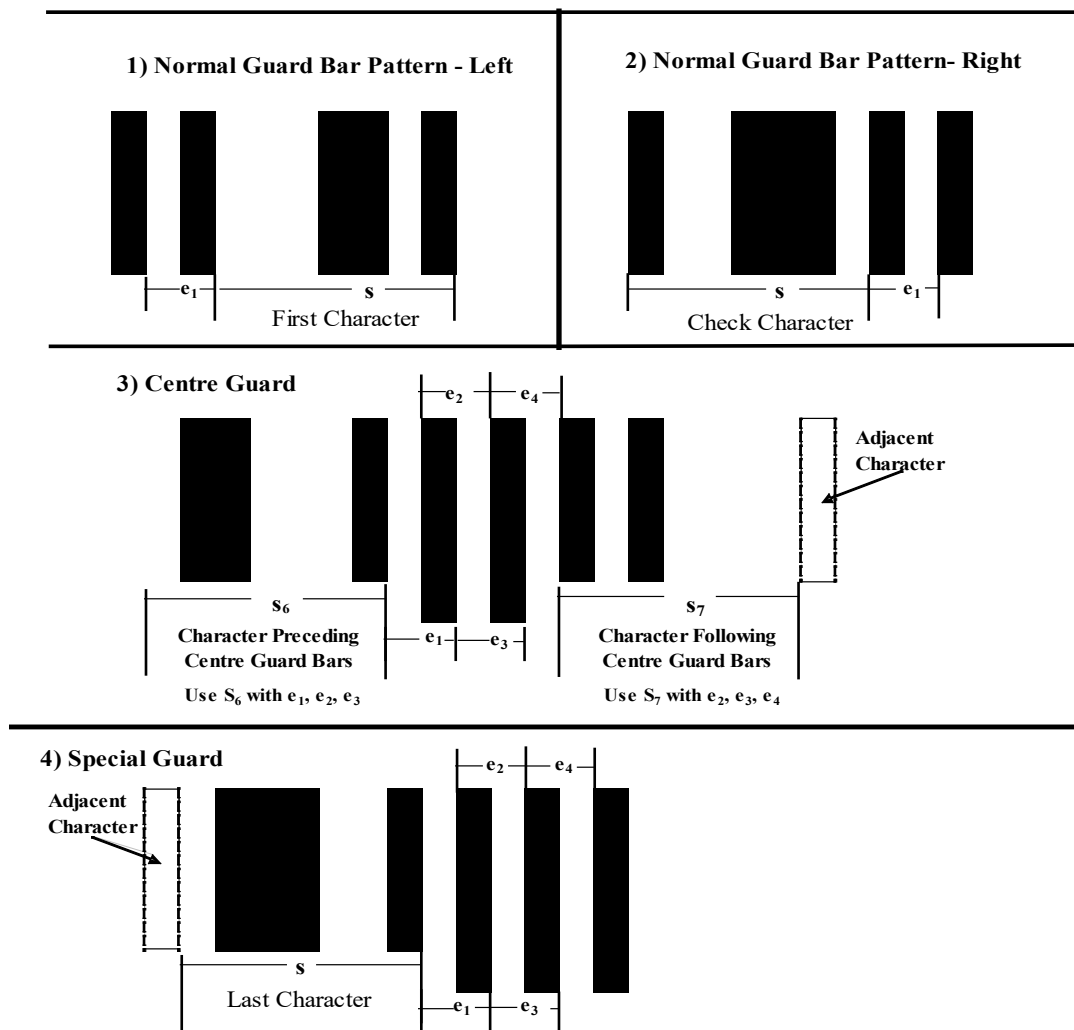

Figure 5.2.2-4. Main symbol auxiliary pattern E values

Auxiliary guard patterns	E1	E2	E3	E4
Normal guard bar pattern	2			
Centre guard bar pattern (left half)	2	2	2	
Centre guard bar pattern (right half)		2	2	2
Special guard bar pattern	2	2	2	2

5.2.3 Human readable interpretation

The human readable digits SHALL be printed underneath the main symbol and above the add-on symbol. A clearly legible font SHALL be used for these digits, and OCR-B as defined in *ISO 1073-2: Alphanumeric character sets for optical recognition; Part 2: Character set OCR-B; Shapes and dimensions of the printed image*, is recommended. This font is referenced only as a convenient standard typeface, and it is not intended that these characters be machine read or verified. Reasonable alternative type fonts and character sizes are acceptable provided the human readable interpretation is clearly legible.

All the encoded digits for EAN-13, UPC-A, and EAN-8 barcodes, and the add-on symbols SHALL be shown in human readable interpretation form. For UPC-E barcodes, the six digits directly encoded together with the leading zero and the implicitly encoded check digit SHALL be shown in human readable interpretation form. Figures 5.2.1.3.1-2, 5.2.1.3.2-1, 5.2.1.3.3-1, 5.2.1.3.4-1, 5.2.1.3.5.1-2, and 5.2.1.3.5.2-2 illustrate each type of symbol and its human readable interpretation.

The minimum space between the top of the digits and the bottom of the bars (dark bars) SHALL be 0.5X. Normally the minimum is one module, which is close enough to keep the human readable interpretation associated with the symbol.

In the EAN-13, the leftmost digit, which is encoded by variable parity, is printed to the left of the start guard pattern in line with the other digits.

For UPC-A and UPC-E barcodes, the size of the first and last digits should be reduced to a maximum width equivalent to four modules. The height is reduced proportionally. The right-hand side of the first digit is positioned five module widths to the left of the leftmost guard bar. The left-hand side of the last digit is positioned five module widths to the right of the rightmost guard bar for UPC-A barcodes and three module widths for UPC-E barcodes. The bottom edge of the first and last digit SHALL be aligned with the bottom edge of the remaining full size digits.

















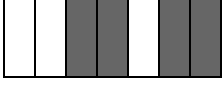

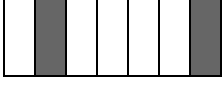







The human readable interpretation of the add-on symbol SHALL be above the symbol. The digits SHALL be the same height as those of the main symbol. The upper edges of the digits are aligned with the upper edges of the bars (dark bars) of the main symbol. The minimum space between the bottom of the digits and the top of the bars (dark bars) SHALL be 0.5X.

Some industries use specific variations of the recommended human readable interpretation, such as inserted hyphens to segment the number field.

5.2.4 Additional features

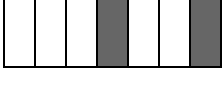

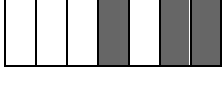
5.2.4.1 Character values in the EAN/UPC symbology family

Figure 5.2.4.1-1. Composition of EAN/UPC symbol characters

Value of character	Number set A (odd)	Number set B (even)	Number set C (even)
0			
1			
2			
3			
4			
5			
6			
7			
8			
9			

5.2.4.2 Auxiliary characters in the EAN/UPC symbology family

Figure 5.2.4.2-1. Composition of EAN/UPC auxiliary characters

Auxiliary character	
Normal guard bar pattern (right and left)	
Centre guard bar pattern	
UPC-E Right guard bar pattern	

5.2.4.3 Logical structure of an EAN-13 and UPC-A barcode excluding Quiet Zones

Figure 5.2.4.3-1. Logical structure of an EAN-13 or UPC-A barcode

Logical structure of an EAN-13 or UPC-A barcode (excluding Quiet Zones)				
Left guard bar pattern	Characters 12 through 7 (left half)	Centre guard bar pattern	Characters 6 through 1 (right half)	Right guard bar pattern
3 modules	42 modules (6x7)	5 modules	42 modules (6x7)	3 modules
Total number of modules = 95				

Figure 5.2.4.3-2. Combination of number sets representing the thirteenth character of an EAN-13

Value of the thirteenth character	Character position											
	Number set used for representing characters 12 through 7						Number set used for representing characters 6 through 1					
	12	11	10	9	8	7	6	5	4	3	2	1
0	A	A	A	A	A	A	ALWAYS USE NUMBER SET C					
1	A	A	B	A	B	B						
2	A	A	B	B	A	B						
3	A	A	B	B	B	A						
4	A	B	A	A	B	B						
5	A	B	B	A	A	B						
6	A	B	B	B	A	A						
7	A	B	A	B	A	B						
8	A	B	A	B	B	A						
9	A	B	B	A	B	A						

5.2.4.4 Logical Structure of an EAN-8 Barcode excluding Quiet Zones

Figure 5.2.4.4-1. Logical structure of an EAN-8 barcode

Logical structure of an EAN-8 barcode (excluding Quiet Zones)				
Left guard bar pattern	Characters 8 Through 5 (Left Half)	Centre guard bar pattern	Characters 4 Through 1 (Right Half)	Right guard bar pattern
3 modules	28 modules (4x7)	5 modules	28 modules (4x7)	3 modules
Total number of modules = 67				

Figure 5.2.4.4-2. Number sets for EAN-8 barcode characters

Character position							
Number set used for representing characters 8 through 5				Number set used for representing characters 4 through 1			
8	7	6	5	4	3	2	1
ALWAYS USE NUMBER SET A				ALWAYS USE NUMBER SET C			

5.2.4.5 Logical structure of a UPC-E barcode excluding Quiet Zones

Figure 5.2.4.5-1. Logical structure of a UPC-E barcode

Logical Structure of a UPC-E Barcode (Excluding Quiet Zones)		
Normal guard bar pattern	Six Symbol Characters (Note the use of variable parity)	Special guard bar pattern (UPC-E)
3 modules	42 modules (6x7)	6 modules
Total number of modules = 51		

Figure 5.2.4.5-2. Number sets for UPC-E barcode characters

Value of prefix digit	Value of check digit	Number sets used for numbering a UPC-E barcode					
		1	2	3	4	5	6
0	0	B	B	B	A	A	A
0	1	B	B	A	B	A	A
0	2	B	B	A	A	B	A
0	3	B	B	A	A	A	B
0	4	B	A	B	B	A	A
0	5	B	A	A	B	B	A
0	6	B	A	A	A	B	B
0	7	B	A	B	A	B	A
0	8	B	A	B	A	A	B
0	9	B	A	A	B	A	B

5.2.4.6 Symbol dimensions at nominal size (X-dimension = 0.33 mm, not to scale)

All measurements in the following figures are in millimetres.

Figure 5.2.4.6-1. EAN-13 barcode

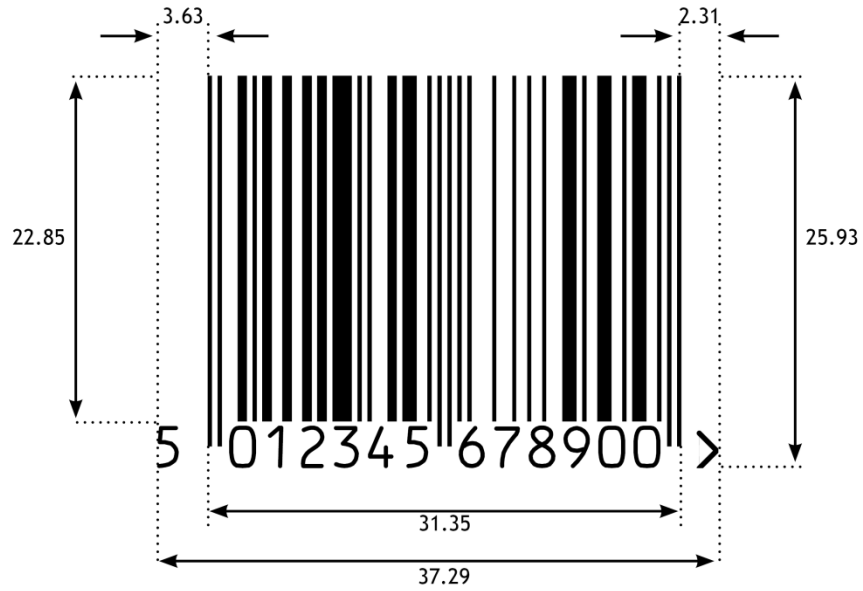

Figure 5.2.4.6-2. UPC-A barcode

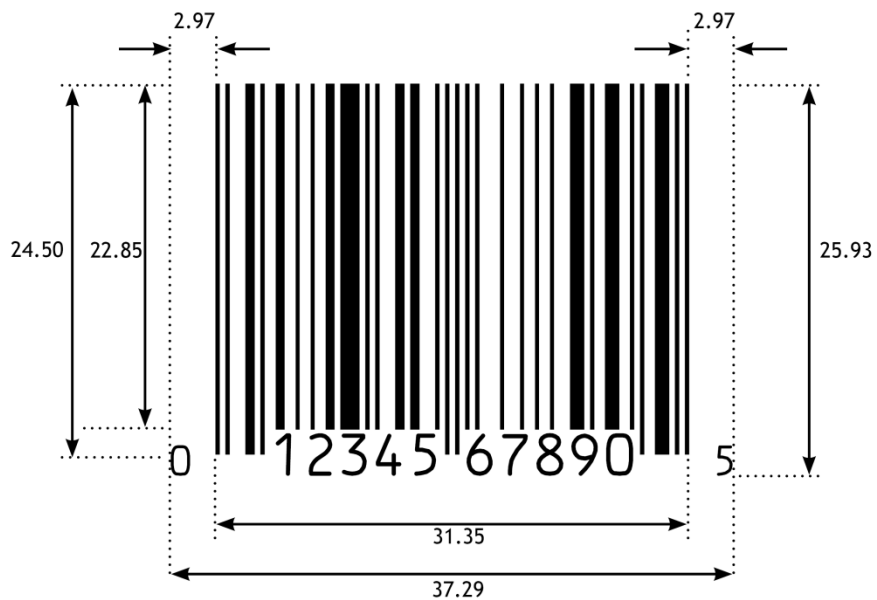

Figure 5.2.4.6-3. EAN-8 barcode



Figure 5.2.4.6-4. UPC-E barcode

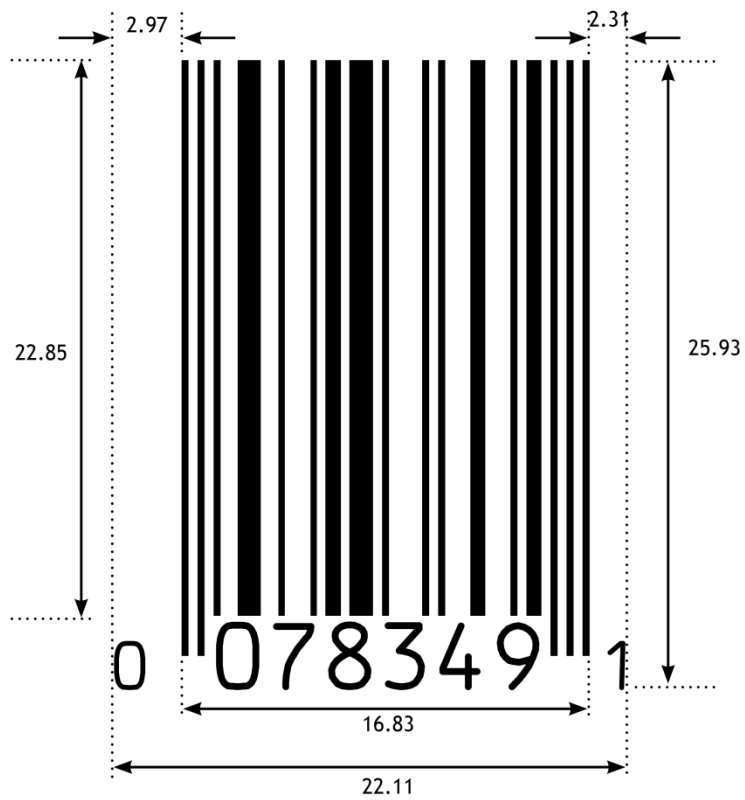

Figure 5.2.4.6-5. UPC-A barcode with two-digit add-on symbol



Figure 5.2.4.6-6. EAN-13 barcode with five-digit add-on symbol



5.2.4.7 Dimensions of modules and symbols at different levels of magnification

Figure 5.2.4.7-1. Dimensions of EAN/UPC symbols and their modules at different levels of magnification

Magnification factor	Ideal module width [mm]	EAN-13/UPC-A dimensions [mm]		EAN-8 dimensions [mm]	
		Width	Height	Width	Height
0.80	0.264	29.83	18.28	21.38	14.58
0.85	0.281	31.70	19.42	22.72	15.50
0.90	0.297	33.56	20.57	24.06	16.41
0.95	0.314	35.43	21.71	25.39	17.32
1.00	0.330	37.29	22.85	26.73	18.23
1.05	0.347	39.15	23.99	28.07	19.14
1.10	0.363	41.02	25.14	29.40	20.05
1.15	0.380	42.88	26.28	30.74	20.96
1.20	0.396	44.75	27.42	32.08	21.88
1.25	0.413	46.61	28.56	33.41	22.79
1.30	0.429	48.48	29.71	34.75	23.70
1.35	0.446	50.34	30.85	36.09	24.61
1.40	0.462	52.21	31.99	37.42	25.52
1.45	0.479	54.07	33.13	38.76	26.43
1.50	0.495	55.94	34.28	40.10	27.35
1.55	0.512	57.80	35.42	41.43	28.26
1.60	0.528	59.66	36.56	42.77	29.17
1.65	0.545	61.53	37.70	44.10	30.08
1.70	0.561	63.39	38.85	45.44	30.99
1.75	0.578	65.26	39.99	46.78	31.90
1.80	0.594	67.12	41.13	48.11	32.81
1.85	0.611	68.99	42.27	49.45	33.73
1.90	0.627	70.85	43.42	50.79	34.64
1.95	0.644	72.72	44.56	52.12	35.55
2.00	0.660	74.58	45.70	53.46	36.46



Note: Refer to section [5.5](#) for the minimum, nominal, and maximum X-dimensions, and symbol heights for barcodes.

5.3 Linear barcodes - ITF-14 symbology specifications

5.3.1 Symbology characteristics

In the GS1 system, the characteristics of ITF-14 symbols are:

- Encodable character set: digits 0 through 9, in accordance with *ISO/IEC 646*. Refer to [Figure 7.11-1](#) for more details.
- Code type: continuous.
- Elements per symbol character: five (two wide and three narrow) encoded as either five bars (dark bars) or five spaces (light bars).
- Self-checking symbol character.
- Data string length encodable: fixed length at 14 digits.
- Bidirectionally decodable.
- One check digit is required (see section [7.9](#)).
- The symbol character density for ITF-14 is 16 to 18 modules per symbol character pair, depending on the wide-to-narrow ratio. The value is 16, based on the target ratio of 2.5 to 1.
- The non-data overhead is eight to nine modules, depending on the wide-to-narrow ratio. The value is 8.5, based on the target ratio of 2.5 to 1.

5.3.2 Symbol structure

An ITF-14 symbol includes:

- A left Quiet Zone.
- A start pattern.
- Seven pairs of symbol characters representing data.
- A stop pattern.
- A right Quiet Zone.

5.3.2.1 Character encodation

5.3.2.1.1 Data character encodation

Figure 5.3.2.1.1-1 defines the ITF-14 symbol's character encodation. In the binary representation column, the character 1 represents a wide element and 0 represents a narrow element.

Figure 5.3.2.1.1-1. Binary representation of character encodation

Data character	Binary representation				
0	0	0	1	1	0
1	1	0	0	0	1
2	0	1	0	0	1
3	1	1	0	0	0
4	0	0	1	0	1
5	1	0	1	0	0
6	0	1	1	0	0
7	0	0	0	1	1
8	1	0	0	1	0
9	0	1	0	1	0

Figure 5.3.2.1.1-1 uses a modified binary coded decimal encoding scheme. The four leftmost bit positions for each character are assigned weights of 1, 2, 4, and 7, from left to right; the fifth position is used for an even parity bit. The sum of the positional weights of the 1 bits is equivalent to the data character value, except in the case of data character 0, where the weights 4 and 7 are applied. The parity bit ensures that there are always two 1 bits per character.

The algorithm shown in figure 5.3.2.1.1-2 defines the rules for converting numeric data into the symbol characters of an ITF-14 symbol (numeric data equals the Global Trade Item Number (GTIN) and, therefore, already contains the check digit).

Figure 5.3.2.1.1-2. Rules for converting numeric data into symbol characters

Step in algorithm	Example
1. Calculate check digit for 0367123456789	367
2. With ITF-14 symbols, the data string, including the check digit, will always be a 14-digit number. The leftmost four digits of this number are 0367.	0367
3. Subdivide the numeric string into digit pairs. The leftmost four digits of the number are 0367.	0367 03 and 67
4. Encode the digit pairs as follows: <ul style="list-style-type: none"> ■ Encode the leading digit of each pair into bar patterns, as shown in figure 5.3.1.2.1-1 ■ Encode the second digit of each pair into space patterns, as shown in figure 5.3.1.2.1-1 	0 and 6 3 and 7
5. Form each symbol character pair by taking the bar (dark bar) and space (light bar) elements alternately from the patterns derived from the two steps in 4, commencing with the first bar (dark bar) of the pattern for the first digit, followed by the first space (light bar) of the pattern for the second digit.	

Figure 5.3.2.1.1-3 illustrates the sequence of bar (dark bar) and space (light bar) elements corresponding to the data character pairs 03 and 67.

Figure 5.3.2.1.1-3. ITF-14 symbol character pairs encoding 03 and 67

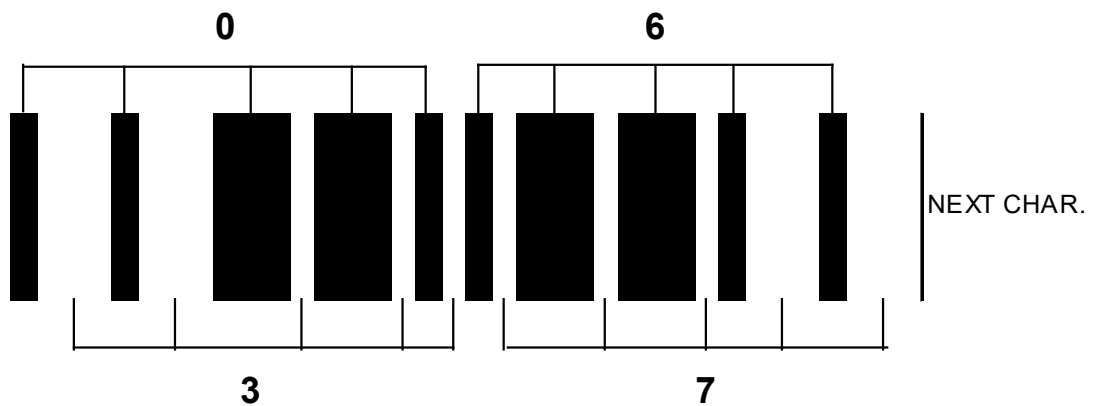

5.3.2.1.2 Start and stop patterns

The start pattern SHALL consist of four narrow elements in the sequence “bar (dark bar) - space (light bar) - bar (dark bar) - space (light bar).” The stop pattern SHALL consist of a “wide bar (dark bar) - narrow space (light bar) - narrow bar (dark bar)” sequence.

The start pattern SHALL be positioned at the normal left end of the symbol characters adjacent to the first bar (dark bar) of the most significant digit. The stop pattern SHALL be positioned at the normal right end of the symbol characters adjacent to the final space (light bar) of the least significant digit.

There is no assigned human readable interpretation of the start and stop patterns, and they SHALL NOT be transmitted by the decoder. Figure 5.3.2.1.2-1 illustrates the start and stop patterns and their relationship to the symbol characters.

Figure 5.3.2.1.2-1. Start and stop patterns

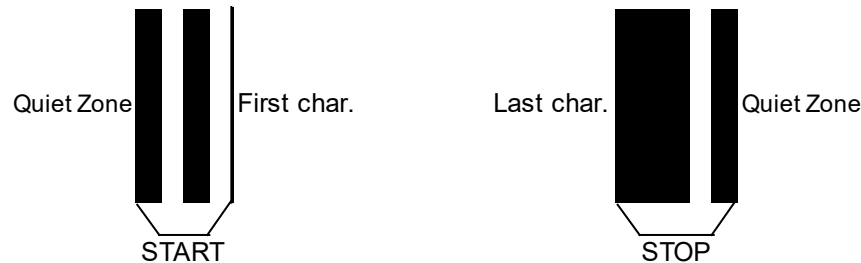

Figure 5.3.2.1.2-2 illustrates a complete barcode for the number 1234, showing the necessary Quiet Zones.

Figure 5.3.2.1.2-2. ITF-14 symbol inclusive of Quiet Zones



5.3.2.1.3 Check digit

A check digit is required in the ITF-14 symbology. Section 7.9 defines the check digit position and calculation.

5.3.2.2 Dimensions and tolerances

ITF-14 symbols SHALL use the following nominal dimensions:

- Width of narrow element (X): the X-dimension of ITF-14 symbols is defined by the application specification based on the needs of the application. Refer to section 5.5.2.6 for specifications by application area.
- The wide/narrow ratio (N): the range is 2.25:1 to 3.0:1 but the actual wide-to-narrow ratio is defined by the application specification based on the needs of the application. Refer to section 5.5.2.6 for specifications by application area.
- The Quiet Zones to the right and left of the symbol are compulsory. The minimum width of each Quiet Zone is 10X.
- A minimum space of 1.02 millimetre (0.040 inch) between the bottom line of the bearer bar and the top of the human readable characters is required.

The length of an ITF-14 symbol, including Quiet Zones, is calculated from the following expression:

$$W = (P(4N+6)+N+6)X+2Q$$

Where:

- **W** is the length in millimetres.
- **P** is the number of character pairs.
- **N** is the wide-to-narrow ratio.

- **X** is the width of a narrow element in millimetres.
- **Q** is the width of the Quiet Zone in millimetres.

As an example, for an ITF-14 symbol that has seven character pairs, a target wide-to-narrow ratio of 2.5:1, a target X width of 1.016 millimetres (0.0400 inch), and Quiet Zone widths of 10.16 millimetres (0.400 inch) the total symbol width is 142.75 millimetres (5.620 inches).

5.3.2.3 Reference decode algorithm

Barcode reading systems are designed to read imperfect symbols to the extent that practical algorithms permit. This section describes the reference decode algorithm used in the computation of the decodability value described in *ISO/IEC 15416*. Decodability SHALL be determined as follows:

- Within each ITF-14 symbol character (representing two digits), sort the bars (b_i) and spaces (s_i) such that:

$$\mathbf{b_1 < b_2 < b_3 < b_4 < b_5}$$

$$\mathbf{s_1 < s_2 < s_3 < s_4 < s_5}$$

- The determined X-dimension (Z) is given by:

$$\mathbf{Z = b_1 + b_2 + b_3 + s_1 + s_2 + s_3 / 6}$$

- Separation value (V_1) is:

$$\mathbf{V_1 = (d/Z) - 0.5}$$

where d = the smaller of ($b_4 - b_3$) or ($s_4 - s_3$)

- Uniformity value (V_2) is:

$$\mathbf{V_2 = 1 - u/Z}$$

where u = the largest of:

$$b_5 - b_4$$

$$b_3 - b_1$$

$$s_5 - s_4$$

$$s_3 - s_1$$

- Narrowest element value (V_3) is:

$$\mathbf{V_3 = [(n/Z) - 0.25] / 0.75}$$

where n = the smaller of s_1 or b_1

- For each symbol character, determine the decodability value V . V is the smallest of V_1 , V_2 , or V_3 .
- The scan profile decodability value is the smallest value of V measured in a Scan Reflectance Profile (SRP). The reference decode algorithm fails when V exhibits a negative value.
- The decodability grade for each profile is determined from the decodability value according to *ISO/IEC 15416*.

5.3.2.4 Bearer bars

The purpose of a bearer bar is to equalise the pressure exerted by the printing plate over the entire surface of the symbol and to enhance reading reliability by helping to reduce the probability of misreads or short scans that may occur when a skewed scanning beam enters or exits the barcode through its top or bottom edge.

The bearer bar is mandatory unless it is not technically feasible to apply it (in which case reading reliability will be reduced).

For printing methods requiring printing plates, the nominal bearer bar has a constant thickness of 4.83 millimetres (0.190 inch) and must completely surround the symbol, including its Quiet Zones, and butt directly against the top and bottom of the bars (dark bars) of the symbol.

For printing methods that do not require printing plates, the bearer bar SHALL be a minimum of twice the width of a narrow bar (dark bar) and need only appear at the top and bottom of the symbol, butting directly against the top and bottom of the symbol bars (dark bars). The bearer bar may extend above and below the Quiet Zones. However, it is not mandatory to print the vertical sections of the bearer bar. See figure 5.3.2.4-1.

Figure 5.3.2.4-1. ITF symbols with bearer bars



5.3.2.5 Human readable interpretation

For human readable interpretation rules see section [4.14](#). For HRI rules specific to regulated healthcare retail consumer trade items, see section [4.14.1](#).

5.3.3 Additional features (informative)

5.3.3.1 Protection against short scans

In ITF-14 symbols, the bar (dark bar) patterns of the start and stop patterns may be found at the respective end and beginning of certain encoded symbol characters within the code. There is, therefore, no guarantee that a partial scan of the symbol will not produce a valid read for an embedded symbol having fewer characters.

In the GS1 system, short scans are very unlikely to happen, as the symbol must always contain 14 digits. However, a symbol containing more than 14 digits may cause a short scan of 14 digits. In this instance, the check digit offers security to detect this error. These are the measures that SHALL be taken to minimise the risk of partial read.

5.3.3.2 Fixed length symbols

In any application standard, the number of characters encoded in an ITF-14 symbol SHALL be fixed for that application and reading or data processing equipment SHOULD be programmed to only accept messages of that defined length. An ITF-14 symbol must always carry a 14-digit number.

5.3.4 Guidelines for the use of ITF-14 (informative)

5.3.4.1 Autodiscrimination compatibility

ITF-14 symbols may be read by suitably programmed barcode readers that are designed to autodiscriminate the ITF symbology from other symbologies. The ITF symbology is fully distinguishable from and compatible with many symbologies including the ISO standard

symbologies. The decoder's valid set of symbologies SHOULD be limited to those needed by a given application to maximise reading security.

5.3.4.2 System considerations

It is important that the various components making up a barcode installation system (e.g., printers, labels, readers) operate in concert. A failure in any component, or a mismatch between components, can compromise the performance of the overall system.

5.3.5 Symbology identifier (informative)

The symbology identifier allocated to the ITF-14 symbol in *ISO/IEC 15424*, which is added as a preamble to the decoded data by a suitably programmed barcode reader, is: **]Im**

where:

] is ASCII character 93.

I (upper case I) is the code character for the ITF-14 symbology.

m is a modifier character.



Note: The symbology identifier **]I1** is the only symbology identifier used by GS1 with the ITF-14 symbol. This information SHALL NOT be encoded in the barcode, but SHALL be generated by the decoder after decoding and transmitting as a preamble to the data message. The value of "m" in the symbology identifier is equal to 1, which indicates the check digit has been validated and transmitted by the scanner.

5.3.6 Test specifications (informative)

To verify whether a symbol meets the specifications of the GS1 system, it SHALL be tested using the specification defined in *ISO/IEC 15416*, which details the conditions under which measurements SHALL be made. The specification defines methods of determining an overall quality grade based on the attributes of the barcode and determining its conformity with the system. For ITF-14 symbols, the reference decode algorithm SHALL be the algorithm specified in section [5.3.2.3](#).

Full details on barcode production and quality assessment can be found in section [5.5](#).

The verifier SHALL determine the average wide-to-narrow ratio (N) for each profile. The value **N** is computed character by character, then averaged over all characters in the symbol. The range indicated below is passing:

2.25 < N < 3.00

N is calculated for each symbol character (pair of data digits) according to the following rule:

$N_i = 1.5 * [(b_4 + b_5 + s_4 + s_5) / (b_1 + b_2 + b_3 + s_1 + s_2 + s_3)]$

The value N for the profile is then obtained by averaging the N_i for all characters in the symbol.

Figure 5.3.6-1. ITF-14 symbol: Main dimensions at X-dimension 1.016 mm (0.0400 in.)



Note: diagram is not intended to be used as a basis for measurement.

5.4 Linear barcodes - GS1-128 symbology specifications

The GS1-128 barcode has been carefully designed through joint co-operation between GS1 and AIM (Association for Automatic Identification and Mobility). Use of GS1-128 barcodes provides a high degree of security and distinguishes GS1 system element strings from extraneous non-standard barcodes.

The GS1-128 symbology is a subset of the more general Code 128 symbology. By agreement between AIM and GS1, use of the Function 1 Symbol Character (FNC1) in Code 128 symbols in the first symbol character position following the start character has been reserved exclusively for the GS1 system. Code 128 is fully described in *ISO/IEC 15417, Information Technology - Automatic Identification and Data Capture Techniques - Bar code Symbology Specification - Code 128*. The information covered in section [5.4](#) includes:

- Sections [5.4.1](#), [5.4.4](#), [5.4.2](#), [5.4.3](#), [5.4.4](#), and [5.4.6](#): GS1-128 symbology subset (using *ISO/IEC 15417* for reference).
- Section [5.4.7](#): GS1-128 symbology application parameters.
- Appendix [5.10](#): GS1 system rules for encoding/decoding element strings in GS1 symbologies using GS1 Application Identifiers.

5.4.1 GS1-128 symbology characteristics

The characteristics of the GS1-128 symbology are:

- Encodable character set:
 - The GS1 system requires that only the subset of *ISO/IEC 646 International Reference Version* defined in these *GS1 General Specifications* be used for GS1 Application Identifier (AI) element strings. Refer to [Figure 7.11-1](#) for the allowed encodable character set.
 - Characters with ASCII values 128 to 255 may also be encoded in Code 128 symbols. Characters with ASCII values 128 to 255 accessed by Function 4 Symbol Character (FNC4) are reserved for future use and are not used in GS1-128 barcodes.
 - Four non-data function characters. FNC2 and FNC4 are not used in GS1-128 barcodes.
 - Four code set selection characters (including single character code set shift).
 - Three start characters.
 - One stop character.
- Continuous code type.
- Six elements per symbol character comprising three bars (dark bars) and three spaces (light bars), each one, two, three, or four modules in width. The stop character is made up of seven elements comprising four bars (dark bars) and three spaces (light bars).
- Character self-checking.
- Variable symbol length.
- Bi-directionally decodable.
- One mandatory symbol check character (see section [5.4.3.6](#)).
- Data character density is 11 modules per symbol character (5.5 modules per numeric character in code set C, 13 modules per stop character).
- Non-data overhead:
 - GS1-128 barcodes have a special double character start pattern consisting of the appropriate start character and immediately followed by a Function 1 Symbol Character Code (FNC1). The FNC1 adds to the symbol's non-data overhead. The total symbol overhead is 46 modules.
 - The FNC1 character may also be used as a separator character between element strings not contained in the predefined table shown in figure A1-1 section [5.10.1](#).
- GS1-128 barcode size characteristics:

- The maximum physical length is 165.10 millimetres (6.500 inch) including Quiet Zones.
- The maximum number of data characters in a single symbol is 48.
- For a given length of data, the symbol size is variable between limits in X-dimension to accommodate the ranges in quality achievable by the various printing processes.

5.4.2 GS1-128 barcode structure

The GS1-128 barcode is made up as follows, reading from left to right:

- Left Quiet Zone
- The double character start pattern:

A start character (A, B, or C)
The Function 1 Symbol Character (FNC1)
- Data (including the GS1 Application Identifier represented in character set A, B, or C).
- A symbol check character.
- The stop character.
- Right Quiet Zone.

For human readable interpretation rules see section [4.14](#). For HRI rules specific to regulated healthcare retail consumer trade items, see section [4.14.1](#).

Figure 5.4.2-1. General format of a GS1-128 barcode



5.4.3 GS1-128 symbology character assignments

Figure 5.4.3.2-1 defines all the Code 128 character assignments. In the element width column, the numeric values represent the widths of the elements in modules or multiples of the X-dimension. GS1-128 barcode character assignments are identical to Code 128 symbol character assignments.

5.4.3.1 Symbol character structure

The sum of the bar modules in any symbol character is always even (even parity) and the sum of the space modules is, therefore, always odd. This parity feature enables character self-checking.

Figure 5.4.3.1-1. GS1-128 barcode start character A

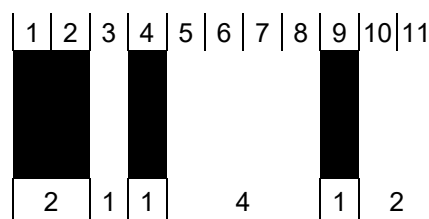

5.4.3.3.2 Code set B

Code set B includes all of the standard upper case alphanumeric characters and punctuation characters together with the lowercase alphabetic characters (e.g., ASCII characters 32 to 127 inclusive) and seven special characters.

5.4.3.3.3 Code set C

Code set C includes the set of 100 digit pairs from 00 to 99 inclusive, as well as three special characters. This allows numeric data to be encoded as two data digits per symbol character.

5.4.3.4 Special characters

The last seven characters of code sets A and B (character values 96 to 102) and the last three characters of code set C (character values 100 to 102) are special non-data characters that, though they have particular significance to the barcode reader, have no ASCII character equivalents.

5.4.3.4.1 Code set and shift characters

Code set and shift characters SHALL be used to change from one code set to another within a symbol. The decoder SHALL NOT transmit them.

- Code set characters: Code A, B, or C characters change the symbol code set from the code set previously defined to the new code set, which is defined by the code character. This change applies to all characters following the code set character until either the end of the symbol, another code set character, or the shift character is encountered.
- Shift character: The shift character changes the code set from A to B or B to A for the single character following the shift character. Characters following the affected character SHALL revert to the code set A or B defined prior to the shift character.

5.4.3.4.2 Function characters

Function characters (FNC) provide special operations and application instructions to the barcode reading device.

- The Function 1 Symbol Character (FNC1) SHALL be subject to the special considerations defined in section [5.4.3.6](#). An FNC1 in the first position following the start character of a Code-128 symbol is at all times a reserved use, which identifies the GS1 system.
- The Function 2 Character (FNC2) (Message Append) is not used in the GS1 system. It instructs the barcode reader to temporarily store the data from the symbol containing the FNC2 and transmit it as a prefix to the data of the next symbol. This may be used to concatenate several symbols before transmission. This character may occur anywhere in the symbol. Where the sequence of data is significant, provision should be made to ensure reading of the symbols in the correct sequence.
- The Function 3 Character (FNC3) (Initialise) instructs the barcode reader to interpret the data from the symbol containing the FNC3 as instructions for initialisation or reprogramming of the barcode reader. The data from the symbol SHALL NOT be transmitted by the barcode reader. This character may occur anywhere in the symbol.
- The Function 4 Character (FNC4) is not used in the GS1 system. In Code 128 symbols, FNC4 is used to represent an extended ASCII character set (byte values 128 to 255) as specified in *ISO 8859-1: Information technology; 8-bit single-byte coded graphical character sets; Part 1: Latin alphabet No.1*, or otherwise in an application specification. If a single FNC4 is used, the value 128 is added to the ASCII value of the following data character in the symbol. A shift character may follow the FNC4 if it is necessary to change the code set for the following data character. Subsequent data characters revert to the standard ASCII set. If two consecutive FNC4s are used, the value 128 is added to the ASCII value of the following data characters until two further consecutive FNC4s are encountered or the end of the symbol is reached. If, during this sequence of extended ASCII encodation, a single FNC4 is encountered, it is used to revert to standard ASCII encodation for the next data character only. Shift and code set characters SHALL have their normal effect during such a sequence. The default reference character set for

extended ASCII values 128 to 255 is the corresponding half of *ISO 8859-1, Latin alphabet 1*, but application specifications may define or reference alternative sets corresponding to byte values 128 to 255.

5.4.3.5 Start and stop characters

- Start characters A, B, and C define the corresponding code set to be used initially in the symbol.
- The stop character is common to all code sets.
- The decoder SHALL NOT transmit start and stop characters.

5.4.3.6 Symbol check character

The symbol check character SHALL be included as the last symbol character before the stop character. Section [5.4.7.6.1](#) defines the algorithm for its calculation. The symbol check character SHALL NOT be represented in the human readable interpretation nor shall it be transmitted by the decoder.

5.4.3.7 GS1-128 symbology start pattern

The GS1-128 symbology has special double character start patterns consisting of start (A, B, or C) and FNC1. These special start characters differentiate GS1-128 barcodes from the more generalised Code 128 symbols.

In other words, a Code 128 symbol, which begins with one of the GS1-128 symbology double character start patterns, is always a GS1-128 barcode; a Code 128 symbol, which does not begin with this start pattern, is never a GS1-128 barcode.

A Function 1 Symbol Character (FNC1) may be the symbol check character (in less than 1 percent of cases). It is also used as a separator character, when appropriate, if element strings are concatenated into a single barcode.

- Start A begins the GS1-128 symbol data encodation according to character set A.
- Start B begins the GS1-128 symbol data encodation according to character set B.

Start C begins the GS1-128 symbol data encodation according to character set C. Start character C SHOULD always be used when the data inclusive of the AI begins with four or more numeric characters.

5.4.3.8 Relationship of symbol character value to ASCII value (informative)

In order to convert symbol character value (S) to ASCII decimal value or vice versa, the following relationships are applicable for code set A and code set B.

- Code set A
 - If:** $S \leq 63$
 - Then:** ASCII value = $S + 32$
 - If:** $64 \leq S \leq 95$
 - Then:** ASCII value = $S - 64$
- Code set B
 - If:** $S \leq 95$,
 - Then:** ASCII value = $S + 32$

The resulting values are shown in figure 5.4.3.2-1.

- ✓ **Note:** As described in section [5.4.3](#), the Function 4 Character (FNC4) is not used in the GS1 system. However, the presence of FNC4 in Code 128 symbols has the effect of adding 128 to

the ASCII value of the subsequent data character or characters derived from the rules given above.

5.4.4 Dimensional requirements

GS1-128 barcodes SHALL conform to the dimensions in the subsections that follow.

5.4.4.1 Minimum width of a module (X-dimension)

The minimum X-dimension is defined by the application specification and requirements (see section [5.5](#)), while considering the equipment available for symbol production and scanning. Application specifications stipulate a target and minimum and maximum width of the X-dimension, see the symbol specifications in section [5.5.2.7](#).

The X-dimension SHALL be constant throughout a given symbol.

5.4.4.2 Quiet Zone

The minimum width of the Quiet Zone to the left and right of the GS1-128 barcode is $10x$.

5.4.4.3 Maximum symbol length

The maximum length of any GS1-128 barcode must be within the following limits:

- The physical length, including Quiet Zones, cannot exceed 165.10 millimetres (6.500 inches).
- The maximum number of encoded data characters is 48, including the GS1 Application Identifier(s) and Function 1 Symbol Character (FNC1) when used as a separator character, but excluding the auxiliary characters and the symbol check character.

5.4.5 Reference decode algorithm

Barcode reading systems are designed to read imperfect symbols to the extent that practical algorithms permit. This section describes the reference decode algorithm used in the computation of the decodability value described in *ISO/IEC 15416*.

The algorithm contains the following steps to decode each character:

- Calculate eight width measurements p , e_1 , e_2 , e_3 , e_4 , b_1 , b_2 , and b_3 (see figure below).

Figure 5.4.5-1. Decode measurements

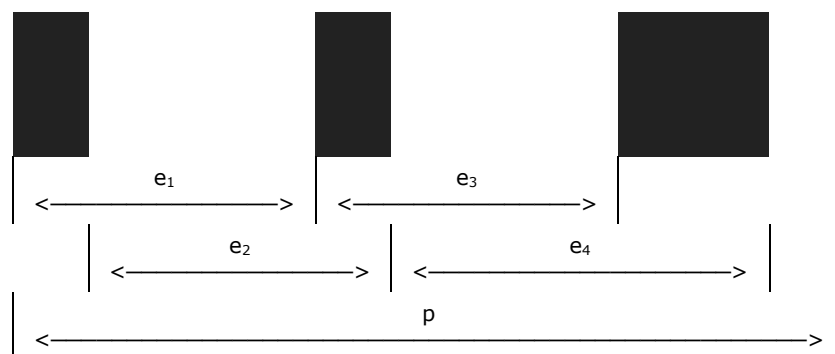

- Convert measurements e_1 , e_2 , e_3 , and e_4 to normalised values E_1 , E_2 , E_3 , and E_4 , which will represent the integral module width (E_i) of these measurements. The following method is used for the i -th value:
 - If $1,5p/11 \leq e_i < 2,5p/11$, then $E_i = 2$
 - If $2,5p/11 \leq e_i < 3,5p/11$, then $E_i = 3$
 - If $3,5p/11 \leq e_i < 4,5p/11$, then $E_i = 4$
 - If $4,5p/11 \leq e_i < 5,5p/11$, then $E_i = 5$

- If $5,5p/11 \leq e_i < 6,5p/11$, then $E_i = 6$
- If $6,5p/11 \leq e_i < 7,5p/11$, then $E_i = 7$

Otherwise the character is in error.

- Look up the character in the decode table using the four values E_1 , E_2 , E_3 , and E_4 as the key (see figure 5.4.5 – 2).
- Retrieve the self-checking symbol character value V , which is stored in the table with the character. The value V is equal to the sum of the modules for the bars (dark bars) as defined for that character.
- Verify that:

$$(V-1, 75)p / 11 < (b_1 + b_2 + b_3) < (V + 1, 75)p / 11$$

Otherwise the character is in error.

The calculation indirectly uses character parity to detect all decode errors caused by single non-systematic one-module edge errors.

Using these five steps, decode the first character. If it is a start character, continue decoding the symbol in the normal forward direction. If it is not a start character but decodes as a stop character, attempt to decode all subsequent characters in the reverse direction.

After all characters have been decoded, make sure there is a valid start character, a valid stop character, and that the symbol check character is correct.

Translate the symbol characters into the appropriate data characters from code set A, B, or C according to the start character, code characters, and shift characters used in the symbol.

In addition, perform other secondary checks on Quiet Zones, beam acceleration, absolute timing, and dimensions that are appropriate considering the specific reading device and intended application environment.



Note: In this algorithm the symbol is decoded using edge to similar edge measurements (e) and an additional measurement of the sum of the three bar (dark bar) widths.

Figure 5.4.5-2. Edge differences for decoding code 128 symbols

Char. value	E1	E2	E3	E4	V	Char. value	E1	E2	E3	E4	V
00	3	3	4	4	6	54	4	2	2	3	6
01	4	4	3	3	6	55	4	2	4	5	6
02	4	4	4	4	6	56	6	4	2	3	6
03	3	3	3	4	4	57	4	3	3	2	6
04	3	3	4	5	4	58	4	3	5	4	6
05	4	4	3	4	4	59	6	5	3	2	6
06	3	4	4	3	4	60	4	5	5	2	8
07	3	4	5	4	4	61	4	3	5	5	4
08	4	5	4	3	4	62	7	4	2	2	6
09	4	3	3	3	4	63	2	2	3	4	4
10	4	3	4	4	4	64	2	2	5	6	4
11	5	4	3	3	4	65	3	3	2	3	4
12	2	3	4	5	6	66	3	3	5	6	4
13	3	4	3	4	6	67	5	5	2	3	4
14	3	4	4	5	6	68	5	5	3	4	4
15	2	4	5	4	6	69	2	3	4	3	4
16	3	5	4	3	6	70	2	3	6	5	4
17	3	5	5	4	6	71	3	4	3	2	4

Char. value	E1	E2	E3	E4	V	Char. value	E1	E2	E3	E4	V
18	4	5	5	3	6	72	3	4	6	5	4
19	4	3	2	4	6	73	5	6	3	2	4
20	4	3	3	5	6	74	5	6	4	3	4
21	3	4	5	3	6	75	6	5	3	3	4
22	4	5	4	2	6	76	4	3	2	2	4
23	4	3	3	4	8	77	5	4	4	2	8
24	4	2	3	4	6	78	6	5	2	2	4
25	5	3	2	3	6	79	4	7	5	2	6
26	5	3	3	4	6	80	2	2	3	6	6
27	4	3	4	3	6	81	3	3	2	5	6
28	5	4	3	2	6	82	3	3	3	6	6
29	5	4	4	3	6	83	2	5	6	3	6
30	3	3	3	3	6	84	3	6	5	2	6
31	3	3	5	5	6	85	3	6	6	3	6
32	5	5	3	3	6	86	5	2	3	3	6
33	2	2	4	5	4	87	6	3	2	2	6
34	4	4	2	3	4	88	6	3	3	3	6
35	4	4	4	5	4	89	3	3	3	5	8
36	2	3	5	4	4	90	3	5	5	3	8
37	4	5	3	2	4	91	5	3	3	3	8
38	4	5	5	4	4	92	2	2	2	5	6
39	3	2	4	4	4	93	2	2	4	7	6
40	5	4	2	2	4	94	4	4	2	5	6
41	5	4	4	4	4	95	2	5	5	2	6
42	2	3	3	4	6	96	2	5	7	4	6
43	2	3	5	6	6	97	5	2	2	2	6
44	4	5	3	4	6	98	5	2	4	4	6
45	2	4	4	3	6	99	2	4	4	5	8
46	2	4	6	5	6	100	2	5	5	4	8
47	4	6	4	3	6	101	4	2	2	5	8
48	4	4	4	3	8	102	5	2	2	4	8
49	3	2	4	6	6	103	3	2	5	5	4
50	5	4	2	4	6	104	3	2	3	3	4
51	3	4	4	2	6	105	3	2	3	5	6
52	3	4	6	4	6	Stop_A	5	6	4	2	6
53	3	4	4	4	8	Stop_B	3	2	2	4	6



Note: Stop_A values are for decoding in a forward direction. Stop_B values apply to the first six elements of the stop character starting at the rightmost side when scanned in a reverse direction.

5.4.6 Symbol quality

5.4.6.1 General

ISO/IEC 15416 defines a standardised methodology for measuring and grading barcodes. Code 128 symbols SHALL be evaluated according to that standard. The reference decode algorithm defined in

section [5.3.2.3](#) SHALL be used for the assessment of the decode and decodability parameters under *ISO/IEC 15416*.



Note: For GS1-128 barcode minimum quality levels, refer to section [5.4.7](#).

5.4.6.2 Decodability

Decodability is a measure of how closely the decode algorithm measurement values approach those in a theoretically perfect symbol. Thus, decodability is a parameter that measures how closely the Scan Reflectance Profile is to approaching decode failure for a given printed symbol.

For the calculation of the decodability value V , the following provisions apply, which supplement those described in *ISO/IEC 15416* for edge to similar edge decodable symbologies:

Substitute V_1 for VC in the formula $VC = K / (S / 2n)$

Where: K = the smallest difference between a measurement and a reference threshold.

N = 11 (number of modules in a symbol character).

S = total width of the character.

Calculate V_2

$$1,75 - (\text{ABS}((Wb \times 11/S) - M))$$

$$V_2 = 1,75$$

Where: M = number of dark modules in the character.

S = total width of the character.

Wb = sum of the bar (dark bar) widths in the character.

ABS = mathematical term for taking the absolute of the calculation that follows.

VC is the lesser of V_1 and V_2 .

The stop character includes an additional terminating bar (dark bar). For the purpose of measuring decodability, the stop character SHOULD be checked twice: first using the six leftmost elements and then using the six rightmost elements from right to left. Both sets of six elements are equivalent in width to a standard character.

5.4.6.3 Quiet Zone measurement

The Quiet Zones to the right and left of the GS1-128 barcode are compulsory. Both Quiet Zones have a minimum width of $10x$.

ISO/IEC 15416 allows for additional pass/fail criteria to be stipulated by a symbology specification. In the case of a GS1-128 barcode, a minimum Quiet Zone of $10Z$ is specified. Both left and right Quiet Zones on each Scan Reflectance Profile (SRP) under *ISO/IEC 15416* SHALL be measured and graded as follows:

Quiet Zone $\geq 10Z$: Grade 4 (A).

Quiet Zone $< 10Z$: Grade 0 (F).

Where Z = the average measured width of the narrow bars (dark bars) and spaces (light bars) (one module) in the symbol.

5.4.6.4 Transmitted data

Transmitted data from a decoded GS1-128 barcode SHALL comprise the byte values of the data characters. It is prefixed by the symbology identifier]C1, if used. The start and stop characters, function characters, code set and shift characters, and symbol check character SHALL NOT be included in the transmitted data.



Note: For GS1-128 symbology implementation, see section [5.4.7](#).

5.4.7 GS1-128 symbology application parameters

5.4.7.1 Symbol height

The symbol height of a GS1-128 symbol depends on the specific application requirements. Please see section [5.5.2.7](#) for minimum symbol height specifications.

5.4.7.2 Symbol length

The dimensions of the GS1-128 barcode depend on the number of characters encoded:

1 start character x 11 modules = 11

Function 1 Symbol Character (FNC1) x 11 modules = 11

1 symbol check character x 11 modules = 11

1 stop character x 13 modules = 13

N symbol characters x 11 modules = 11N

(11N + 46) modules

Where N is the number of symbol characters, any auxiliary characters (shift and code characters) embedded in the data are included.

A module is equal to the X-dimension of the symbol.

Character set C allows two digits to be encoded in one symbol character. Thus, numeric data can be encoded with twice the density of other data when using character set C.

In addition, Quiet Zones to the right and left of the barcode are compulsory and both have widths of 10 modules.

Thus total symbol length, including Quiet Zones, is: **(11N + 66) modules = (11N + 66) X**

5.4.7.3 Maximum symbol length

Two parameters have to be taken into consideration for defining the maximum length of a GS1-128 barcode: the physical length, which depends on the number of characters encoded and the module width (or X-dimension) used, and the number of data characters encoded excluding the auxiliary characters.

The maximum length of any GS1-128 barcode must be within the following limits:

The physical length, including Quiet Zones, cannot exceed 165.10 millimetres (6.500 inches).

The maximum number of encoded data characters is 48, including the GS1 Application Identifier(s) and Function 1 Symbol Character (FNC1) when used as a separator character, but excluding the auxiliary characters and the symbol check character.

5.4.7.4 Human readable interpretation

For human readable interpretation rules see section [4.14](#). For HRI rules specific to regulated healthcare retail consumer trade items, see section [4.14.1](#).

5.4.7.5 Transmitted data (FNC1)

The following GS1-128 symbology implementation specifications are in accordance with *ISO/IEC 15417 Appendix 2* for transmitted data:

- The Function 1 Symbol Character (FNC1) may validly occur as the symbol check character.
- FNC1 in the third or subsequent character position is transmitted as the control character <GS> (ASCII value 29 (decimal), 1D (hexadecimal)).

- For symbols using FNC1 in the first data position scanners SHOULD have symbology identifiers enabled.

When FNC1 is used in the first position, it SHALL NOT be represented in the transmitted message, although its presence is indicated by the use of modifier value 1 in the symbology identifier.

5.4.7.6 Additional features of GS1-128 (normative)

5.4.7.6.1 Symbol check character

The GS1-128 symbol check character SHALL be calculated according to the following rules.

1. Retrieve the symbol character value from figure 5.4.3.2-1.
2. Each symbol character position is given a weight. The start character is weighted 1. Then, beginning on the left with the first symbol character following the start character, the weights are 1, 2, 3, and 4 to...n for all subsequent symbol characters up to, but not including, the symbol check character itself; n denotes the number of symbol characters representing data or special information in the symbol, exclusive of the start and stop characters and symbol check character.
 - ✔ **Note:** Both the start character and the first symbol character following the start character (the Function 1 Symbol Character (FNC1) for all GS1-128 barcodes) are weighted by one.
3. Each symbol character value is multiplied by its weight.
4. The products of the calculations in step 3 are totalled.
5. The sum of the products is divided by 103.
6. The remainder derived from the calculation in step 5 is the symbol character value of the symbol check character.

Figure 5.4.7.6.1-1 shows how to calculate the symbol check character value for the batch number 2503X using the GS1-128 barcode.

Figure 5.4.7.6.1-1. Symbol check character value calculation example
Start C FNC1 10(*) 25 03 Code B X [symbol check character] Stop

Characters	Start C	FNC1	10	25	03	Code B	X
Character values (Step 1)	105	102	10	25	3	100	56
Weights (Step 2)	1	1	2	3	4	5	6
Products (Step 3)	105	102	20	75	12	500	336
Sum of products (Step 4)	1150						
Divide by 103 (Step 5)	1150 / 103 = 11						
Remainder = symbol check character value	17						

(*) GS1 Application Identifier (10) is defined as batch or lot number.

The symbol check character SHALL be positioned immediately after the final data character and before the stop character.

- ✔ **Note:** The symbol check character SHALL NOT be shown in the human readable interpretation.

5.4.7.7 Recommended use of symbol characters to minimise GS1-128 symbol length (informative)

The same data may be represented in different GS1-128 barcodes through the use of different combinations of Start A, Start B, Start C, FNC1, Code A, Code B, Code C and Shift characters.

The following steps may be implemented in printer control software to minimise the number of symbol characters needed to represent a given data string (and, therefore, reduce the overall symbol length).

1. Begin with characters Start C and FNC1.
2. If the data begins with an odd number of digits, insert a Code B character before the last digit.
3. If in a code set B there are four or more consecutive digits, and:
 - a. If there is an even number of digits, insert a Code **C** character before the first digit to change to code set C.
 - b. If there is an uneven number of digits, insert a Code **C** character immediately after the first digit to change to code set C.
4. When in code set C and a non-numeric character occurs in the data, insert a code set A or code set B character before that character.



Note: Code set A may still be used to create GS1-128 barcodes but it encodes fewer data character options than code set B. Code set C encodes a pair of digits as one symbol character so it is more space efficient when encoding four or more consecutive digits. There is no need to use code set A to encode <GS> as a separator character because FNC1 may be used for this purpose.

5.4.7.8 Guidelines for the use of Code 128 (informative)

5.4.7.8.1 Autodiscrimination compatibility

Code 128 symbols may be read by suitably programmed barcode readers that have been designed to autodiscriminate these symbols from other symbologies. Code 128 symbology is fully distinguishable from and compatible with the following linear symbologies:

- ITF (Interleaved 2 of 5).
- Codabar.
- Code 39.
- Code 93.
- EAN/UPC.
- Telepen.
- GS1 DataBar.

5.5 Barcode production and quality assessment

5.5.1 Introduction

This section has been evolving to meet the changes to data carriers and their use within the GS1 system. Some of those changes are, for example, dimension requirements, the introduction of new symbols (e.g., GS1 DataBar and Composite Component), and the shift from the use of analogue film masters to digital barcode files.

Consideration should be given to how these changes affect barcode production and the maintenance of quality in the production process.

5.5.2 Dimensional specifications and operational requirements

Over the years, operational requirements of GS1 system users have influenced the dimensional specifications of GS1 system symbols, and these dimensional specifications have in turn influenced the development of scanning system optics and printing processes. The dimensional requirements for each application area defined in section 2 are set out in the GS1 system symbol specification tables (SSTs) (see section [5.5.2.7](#)). Each SST provides the following barcode specification detail:

- The barcode(s) specified by the GS1 system for each application area.
- The minimum, target, and maximum X-dimension (narrow element width) for the symbol, based on the scanning environment. Please note that a smaller X-dimension may result in a lower scanning performance.
- The minimum and target barcode height, based on the scanning environment. Please note that reducing the symbol height may result in a lower scanning performance.
- The Quiet Zone width and, for primary and secondary symbols, the minimum and maximum separation between the two symbols. (These measurements are expressed as multiples of the X-dimension in the form nX .)
- The minimum ISO quality specification expressed as **g.g/aa/www**, where **g.g** is the minimum overall symbol grade to one decimal place (on a 4.0 scale), **aa** is the effective measuring aperture in thousandths of an inch, and **www** is the wavelength of the light source in nanometres.

 **Note:** Please refer to section 2 for any specific application standard (such as section [2.1.2.5](#), Fixed measure - regulated healthcare retail consumer trade items, and section [2.1.4](#), Fixed measure - direct marking) that may supplement or supersede these symbol specification tables for specific application areas.

Before determining the exact symbol specification required, additional factors, such as the scanning environment, SHALL be considered. These are summarised in section [5.5.2.1](#).

5.5.2.1 Role of the symbol's dimensional specifications

The four major dimensional specifications are the symbol's minimum, target, and maximum X-dimensions, and the symbol's minimum bar height. These dimensional characteristics are always specified for a particular operating environment. The minimum and maximum X-dimensions are determined by the scanner's operating range (field of view). The target X-dimension is the ideal size for a particular application, and is only affected by the choice between linear or two-dimensional symbols (when the application allows for both symbol types). The barcode's height is determined by the ergonomic aspects of product handling when using a scanner. These dimensional specifications are critical for the efficient use of all scanners.

5.5.2.2 Omnidirectional scanning and the term magnification

The EAN/UPC symbology was originally designed for omnidirectional scanners. For this type of scanner, the specifications define a fixed relationship between the symbol's width and height. The term "fixed aspect ratio" is used to refer to this fixed proportion. For example, an EAN-13 symbol

with an X-dimension of 0.330 mm (0.0130 inch), its nominal dimension, has a width of 37.29 mm (1.468 inch) and a bar height of 22.85 mm (0.900 inch).. The term magnification has been used to refer to a range of sizes below, at, or above the nominal dimension (100% magnification) for EAN/UPC symbols used in the omnidirectional scanning environment. The symbol specification tables (SSTs) do not use magnification values and instead list the target, minimum, and maximum values for the symbol's X-dimension and height.

5.5.2.3 Laser versus image based scanning

Most scanners based on laser technology can scan all linear symbologies in the GS1 system. New laser and linear array scanners are even capable of scanning GS1 DataBar and Composite Component symbols. 2D Imaging technology, such as array scanners and vision systems, are capable of scanning all symbols in the GS1 system, including GS1 approved 2D symbols (GS1 DataMatrix and GS1 QR Code). Note that linear imagers, like laser scanners, cannot scan approved 2D symbols; only 2D or array imaging scanners can scan GS1 approved 2D symbols, as well as camera based or vision systems.

5.5.2.4 Printing considerations

The functional and operative bands provide printers and labellers with the flexibility needed to produce quality symbols over a wide range of processes. Once a scanning operational environment is determined and the allowable specification range is known, the printer should be consulted for guidance on:

- The minimum recommended symbol size based on printing press or print characterisation tests.
- Colour/substrate considerations (e.g., separate print station for symbol or double ink layer).
- The optimum orientation of the symbol on the printed web (the direction of movement of the media in relation to a printing plate on a printing press).
- Direct part marking, such as is done by dot peening on items, requires special considerations for material properties.
- Laser or chemically etched parts with low contrast or light marked elements on a dark background (e.g., circuit boards and electronic components, medical instruments, surgical implants).
- High-speed ink jet printed parts and components where the marked dots cannot form a scannable linear symbol.
- Very small items that require a symbology with a square aspect ratio and/or cannot be marked within the allocated packaging space by existing GS1 DataBar and Composite symbols.

5.5.2.5 Packaging considerations

Once a scanning operational environment is determined and the allowable symbol characteristics are known, the package designer should be consulted to:

- Ensure the symbol will not be obstructed by other graphics or package design parameters (e.g., folds, creases, corner wraps, flaps, laminates, embossed logos/patterns, text).
- Ensure that only the symbol intended for scanning will be scanned (e.g., obscure all symbols on the individual units within larger trade items so that the individual units' symbols do not scan instead of the larger unit's symbol).

Section 6 contains complete information on symbol placement criteria to meet quality and ergonomic needs.

5.5.2.6 Operative scanning environments for GS1 system symbols

5.5.2.6.1 GS1 system scanner functional operative bands

Symbol selection and specifications for AIDC application standards are centralised in the symbol specification tables. In establishing X-dimension specifications for symbol specification tables, the

scanner functional operative bands below are normative as they illustrate X-dimension ranges deployed by industry based on GS1 standards. The twelve scanner functional bands that have evolved to meet user needs are illustrated in the figure below.

Figure 5.5.2.6.1-1. GS1 scanner functional operative bands

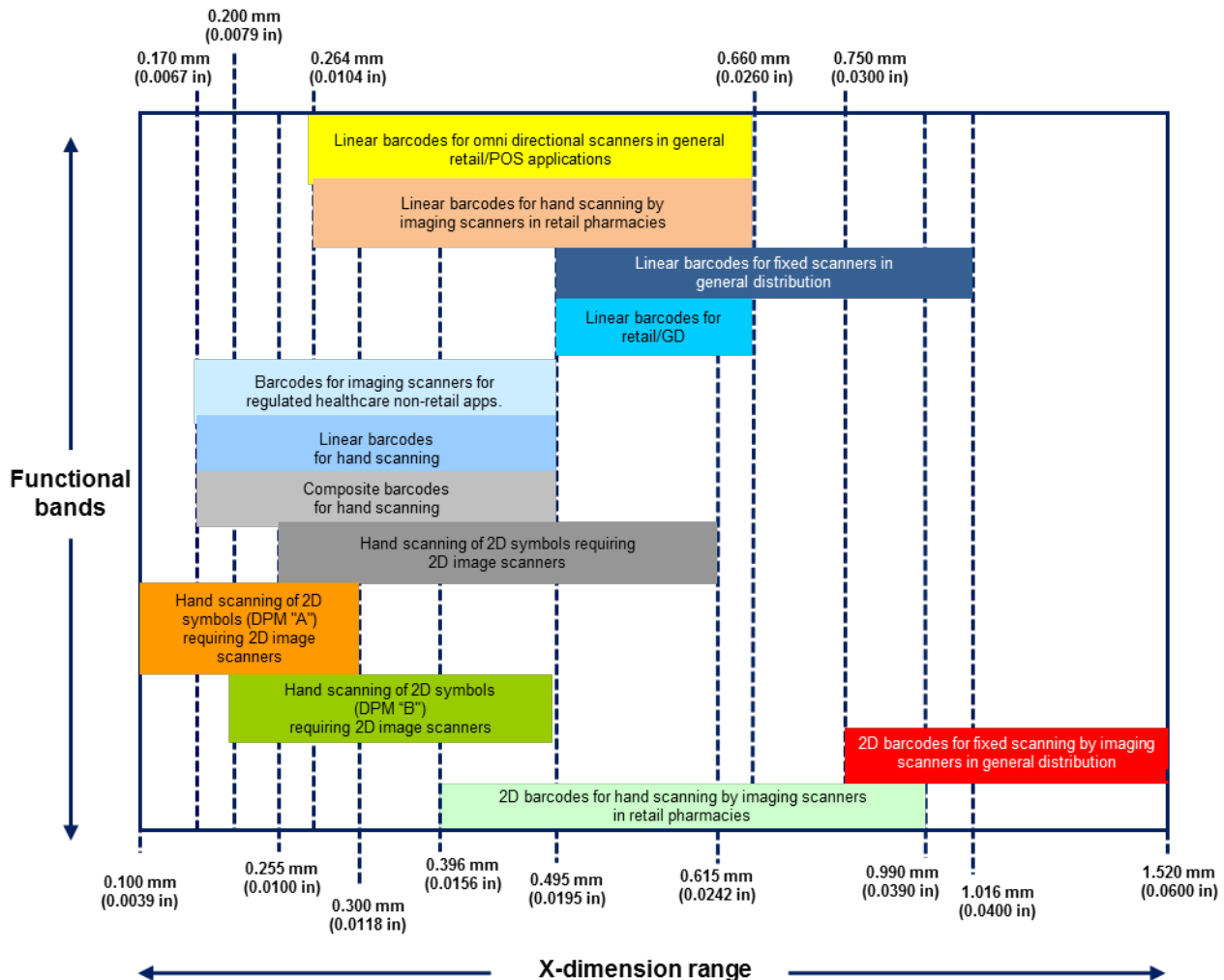

Note: Figure not to scale and target size for each functional band can be found in the symbol specification tables (see section [5.5.2.7](#))

The scanner functional bands

- The omnidirectional scanners for general retail/POS band is primarily intended for general retail consumer trade items to provide orientation-free scanning in high-volume check-out lanes. Scanners are designed to read over-square symbols such as EAN/UPC and GS1 DataBar Retail POS family. The approximate average distance between scanner and symbol is 100 millimetres (4 inches).
- The linear barcodes for imaging scanners for retail pharmacies band is intended for regulated healthcare consumer trade items sold in a pharmacy or apothecary that is a separate retail store or a "controlled" area for distribution of healthcare trade items inside a larger retail operation. This band allows for the use of 2D symbols but this functional band shows the X-dimension ranges used for linear barcodes. Over the counter trade items that are sold in retail pharmacy but also general retail are marked according to general retail scanning specifications.
- The fixed scanners in general distribution band is primarily intended to facilitate automated scanning of trade items packaged for transport and logistic units using fixed mount scanners. In

this environment it is essential to maintain symbol height and location to achieve acceptable scan rates.

- Linear barcodes for both retail and general distribution band covers trade items in specific packaging suitable for transport purposes in General distribution scanning, but that are also scanned as General Retail consumer trade items. See the overlap area between EAN/UPC retail and general distribution (Retail/GD) in figure 5.5.2.6.1-1.
- The imaging scanners for non-retail regulated healthcare trade items band is intended for non-retail regulated healthcare consumer trade items sold outside of the retail channel. For example these X-dimension bands should be used for products destined for hospitals or nursing homes that will never be scanned in a retail pharmacy.
- The linear barcodes for hand scanning band is intended for non-retail trade items using a linear barcode.
- The Composite Component barcodes for hand scanning band is intended for non-retail trade items using Composite Component barcodes which are, in effect, a multi-row 2D linear barcode. In general, the rule is that Composite Components SHALL be printed at the same X-dimension as their linear host. GS1 DataMatrix symbols SHALL be printed at X-dimensions that are 50 percent greater than corresponding linear symbols with Composite Components. Therefore, the bands for linear symbols and Composite Components are very similar in X-dimension and if the same scanner types are chosen, as in the case of Composite symbols, the bands become one.
- The 2D barcodes for automated scanning by imaging scanners in general distribution band has been added to show the X-dimension band used by those who support general distribution of regulated healthcare consumer trade items which may be marked with GS1 DataMatrix.
- 2D barcodes for imaging scanners for retail pharmacy band is intended for regulated healthcare consumer trade items sold in a pharmacy or apothecary that is a separate retail store or a "controlled" area for distribution of healthcare trade items inside a larger retail operation. This band allows for the use of linear symbols but this functional band shows the X-dimension ranges used for 2D barcodes. Over the counter trade items that are sold in retail pharmacy but also general retail are marked according to general retail scanning specifications.
- Today, there is no functional band for mobile devices as the variables of symbol selection, data, operative scanning environment, and allowable symbol specifications for size would require a detailed table solely for mobile devices. At this time, the assumption for mobile devices is that they will support all currently approved symbols, symbol data scenarios, and symbol size specifications however where testing and/or practical experience shows a constraint, this will be addressed in GS1 standards.

Figure 5.5.2.6.1-2. GS1 symbology operational environment decision tree

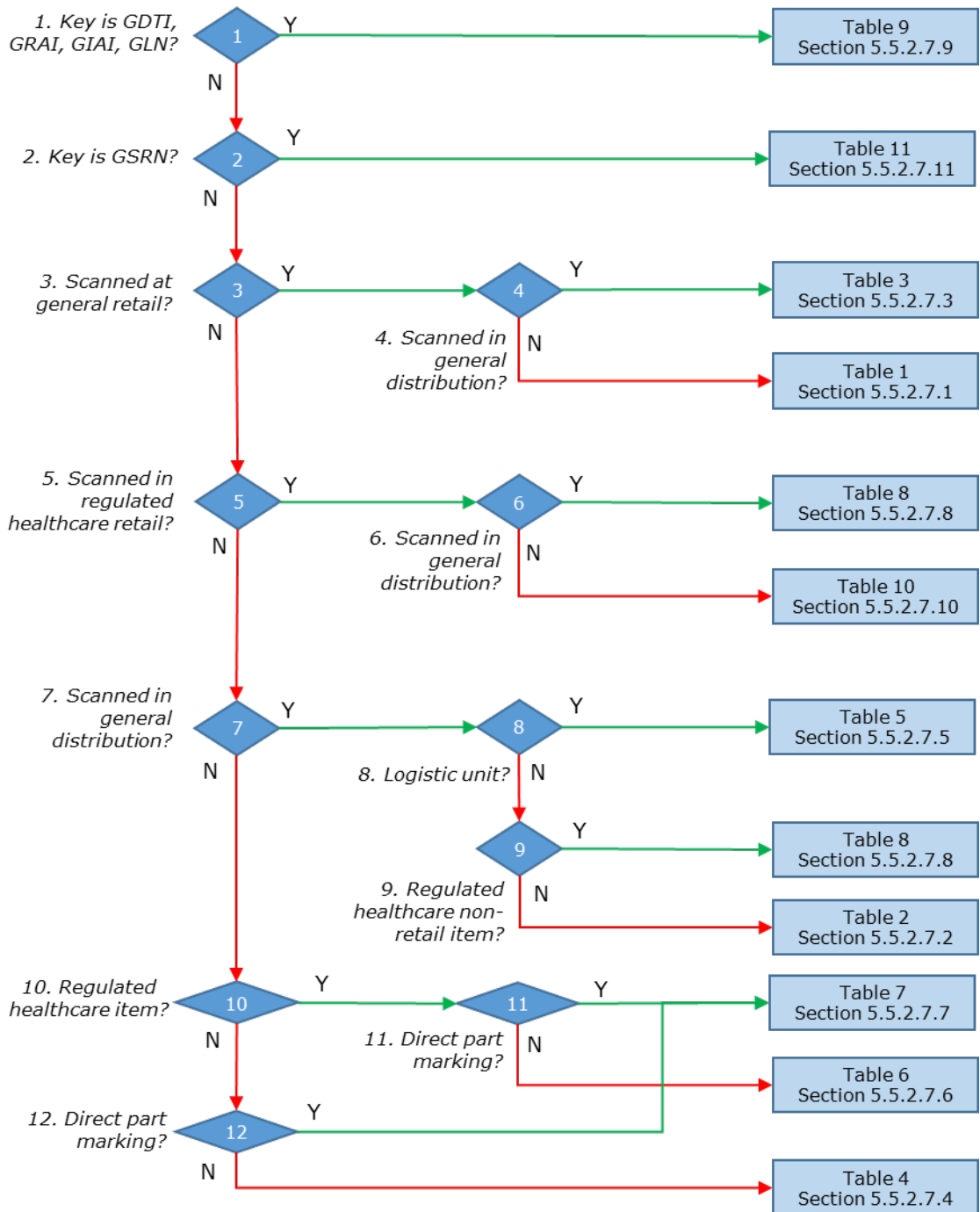

Note: If an item is a general retail consumer trade item and regulated healthcare retail consumer trade item then the barcode marking for general retail is required at a minimum.

Figure 5.5.2.6.1-3. Summary of the symbol specification tables per following figure 5.5.2.6.1-2
GS1 symbology operational environment decision tree

Symbol spec. tables	General retail POS	Retail pharmacy	* Non-retail pharmacy	Non-retail Non-healthcare	General distribution	Direct part marking	Logistics unit (SSCC)	GIAI, GRAI, GLN	GSRN
Table 1	Yes				No				
Table 2				Yes	Yes				
Table 3	Yes				Yes				
Table 4				Yes	No				
Table 5					Yes		Yes		
Table 6			Yes		No				
Table 7			Yes	Yes	No	Yes			
Table 8		Yes	Yes		Yes				
Table 9					No			Yes	
Table 10		Yes			No				
Table 11									Yes
* Table 6 should be used for products scanned at bedside									

5.5.2.7 GS1 system symbol specification tables

In order to find the correct barcode specification, you must:

- Find the appropriate GS1 system application area using figure 5.5.2.6.1-1.
- If the application area references two symbol specification tables, use the decision tree in figure 5.5.2.6.1-2 to determine which one to use.

The figure below provides a quick reference list of the symbol quality parameters depending on their type and their application.

Figure 5.5.2.7-1. Quick reference on symbol quality

Symbology	Application or ID key	ISO (ANSI) symbol grade	Aperture	Wavelength
EAN/UPC	GTIN-8	1.5 (C)	See symbol specification tables 1, 2, 3, 4, 6, 8 and 10 for values	660 nm +/-10
EAN/UPC	GTIN-12	1.5 (C)	See symbol specification tables 1, 2, 3, 4, 6, 8 and 10 for values	660 nm +/-10
EAN/UPC	GTIN-13	1.5 (C)	See symbol specification tables 1, 2, 3, 4, 6, 8 and 10 for values	660 nm +/-10
GS1-128	GTIN-12, GTIN-13, GTIN-14	1.5 (C)	See symbol specification tables 2, 4, 5, 6, 8, 9 and 10 for values	660 nm +/-10
GS1-128	SSCC	1.5 (C)	10 mils	660 nm +/-10
ITF-14 (<0.635 mm (0.025 in.) X)	GTIN-12, GTIN-13, GTIN-14	1.5 (C)	See symbol specification tables 2, 4, 6, 8, and 10 for values	660 nm +/-10
ITF-14 (≥0.635 mm (0.025 in.) X)	GTIN-12, GTIN-13, GTIN-14	0.5 (D)	20 mils	660 nm +/-10
Composite	GTIN-8, GTIN-12, GTIN-13,GTIN-14 and other AIs	1.5 (C)	6 mils	660 nm +/-10
GS1 DataBar	GTIN-8, GTIN-12, GTIN-13,GTIN-14 and other AIs	1.5 (C)	See symbol specification tables 1, 2, 3, 4, 6, 8 and 10	660 nm +/-10
GS1 DataMatrix	Direct part marking, regulated healthcare retail or non-retail consumer trade items extended packaging	1.5 (C)	See symbol specification tables 6, 7, 8, 9, 10 and 11 Table 1 Addendum for values.	660 nm +/-10
GS1 QR Code	Direct part marking, custom trade item, extended packaging GDTI, and GSRN	1.5 (C)	See symbol specification table 1 Addendum, 7, 9, and 11 for values.	660 nm +/-10



5.5.2.7.1 Symbol specification table 1 - Trade items scanned in general retail POS and not general distribution

Figure 5.5.2.7.1-1. GS1 system symbol specification table 1

Primary symbol(s) specified	X-dimension mm (inches)			(**) Minimum symbol height for given X mm (inches)			Quiet Zone		Minimum quality specification
	(*) Minimum	Target	Maximum	For minimum X-dimension	For target X-dimension	For maximum X-dimension	Left	Right	
EAN-13	0.264 (0.0104")	0.330 (0.0130")	0.660 (0.0260")	18.28 (0.720")	22.85 (0.900")	45.70 (1.800")	11X	7X	1.5/06/660
EAN-8	0.264 (0.0104")	0.330 (0.0130")	0.660 (0.0260")	14.58 (0.574")	18.23 (0.718")	36.46 (1.435")	7X	7X	1.5/06/660
UPC-A	0.264 (0.0104")	0.330 (0.0130")	0.660 (0.0260")	18.28 (0.720")	22.85 (0.900")	45.70 (1.800")	9X	9X	1.5/06/660
UPC-E	0.264 (0.0104")	0.330 (0.0130")	0.660 (0.0260")	18.28 (0.720")	22.85 (0.900")	45.70 (1.800")	9X	7X	1.5/06/660
GS1 DataBar Omni-directional (****)	0.264 (0.0104")	0.330 (0.0130")	0.660 (0.0260")	12.14 (0.478")	15.19 (0.598")	30.36 (1.195")	None	None	1.5/06/660
GS1 DataBar Stacked Omni-directional (***) (****)	0.264 (0.0104")	0.330 (0.0130")	0.660 (0.0260")	25.10 (0.988")	31.37 (1.235")	62.70 (2.469")	None	None	1.5/06/660
GS1 DataBar Expanded	0.264 (0.0104")	0.330 (0.0130")	0.660 (0.0260")	8.99 (0.354")	11.23 (0.442")	22.44 (0.883")	None	None	1.5/06/660
GS1 DataBar Expanded Stacked (****)	0.264 (0.0104")	0.330 (0.0130")	0.660 (0.0260")	18.75 (0.738")	23.44 (0.923")	46.86 (1.845")	None	None	1.5/06/660

Primary Symbol(s) Specified Plus Add-on 2 or 5	X-dimension mm (inches)			(**) Minimum symbol height for given X mm (inches)			Quiet Zone	Min separation between symbols	Max separation between symbols	Quiet Zone	Min. Quality Spec.
	(*) Minimum	Target	Maximum	For min. X-dimension	For target X-dimension	For max. X-dimension					
EAN-13 + 2	0.264 (0.0104")	0.330 (0.0130")	0.660 (0.0260")	18.28 (0.720")	22.85 (0.900")	45.70 (1.800")	11X	7X	12X	5X	1.5/06/ 660
EAN-13 + 5	0.264 (0.0104")	0.330 (0.0130")	0.660 (0.0260")	18.28 (0.720")	22.85 (0.900")	45.70 (1.800")	11X	7X	12X	5X	1.5/06/ 660
UPC-A + 2	0.264 (0.0104")	0.330 (0.0130")	0.660 (0.0260")	18.28 (0.720")	22.85 (0.900")	45.70 (1.800")	9X	9X	12X	5X	1.5/06/ 660
UPC-A + 5	0.264 (0.0104")	0.330 (0.0130")	0.660 (0.0260")	18.28 (0.720")	22.85 (0.900")	45.70 (1.800")	9X	9X	12X	5X	1.5/06/ 660
UPC-E + 2	0.264 (0.0104")	0.330 (0.0130")	0.660 (0.0260")	18.28 (0.720")	22.85 (0.900")	45.70 (1.800")	9X	7X	12X	5X	1.5/06/ 660
UPC-E + 5	0.264 (0.0104")	0.330 (0.0130")	0.660 (0.0260")	18.28 (0.720")	22.85 (0.900")	45.70 (1.800")	9X	7X	12X	5X	1.5/06/ 660

(*)	<p>These barcodes may only be printed using an X-dimension below 0.264 millimetre (0.0104 inch) under the following conditions:</p> <ul style="list-style-type: none"> ■ The allowance for X-dimensions between 0.249 millimetre (0.0098 inch) and 0.264 millimetre (0.0104 inch) is only applicable to on demand (e.g., thermal, laser) print processes. For all other printing processes, an X-dimension of 0.264 millimetre (0.0104 inch) is attainable and is the minimum allowable size. ■ When printing a minimum symbol with any method of printing, the area provided for printing the symbol and the required Quiet Zone SHOULD never be less than the area required for an X-dimension of 0.264 millimetre (0.0104 inch).
(**)	<ul style="list-style-type: none"> ■ The minimum symbol height dimensions listed for all symbologies including EAN/UPC symbols do not include the human readable interpretation. ■ When printing a minimum symbol with any method of printing, the bar height SHALL never be truncated below the minimum as listed in the table above. ■ Because of the operative scanning environment for EAN/UPC symbols, there is a direct relationship between the symbol's height and width. This means the minimum symbol height listed is tied to the minimum, target, and maximum X-dimension listed. There is no maximum for the height, but if the maximum X-dimension is used, the symbol height must be equal to or greater than those listed in the Minimum Symbol Height column. ■ The minimum heights of EAN/UPC symbols do not include the extended bars: see section 5.2.1.4.2 for dimensions of the extended bars. ■ For GS1 DataBar Expanded Stacked symbols, the table reflects the minimum symbol height for symbols that are two rows in height.
(***)	<p>In addition to the factors above related to digital printing, one other exception is permitted; For loose produce being weighed at the point-of-sale (POS) using GS1 DataBar Stacked Omnidirectional minimum X-dimension of 0.203 millimetre (0.0080 inch) is permitted but may produce scanning performance reduction. However, for POS, this performance drop off is not noticeable when the product must be weighed at the point-of-sale. Even with a slower scanning performance to conduct the transaction, the weighing process takes longer than the scanning process. For that reason, a lower minimum X-dimension should never be used on products crossing point-of-sale which are not weighed as loose produce during the scan event.</p>
(****)	<p>The current symbol specification for GS1 DataBar Omnidirectional (minimum height 33X) and GS1 DataBar Stacked Omnidirectional (minimum height 69X) indicate a square aspect ratio for the symbol segments. To enhance scanning performance, in an omnidirectional scanning environment, an over square aspect ratio SHALL be used following the example of the EAN/UPC symbology specification and rigorous field test of the GS1 DataBar symbology (46X or 95X).</p>
(*****)	<p>For North American coupon codes using GS1 DataBar Expanded Stacked in 2 row and 3 row configurations the X-dimension may be as low as 0.0080" (0.203mm) as long as a minimum overall bar height of 1.020" (25.91mm) is maintained. X-dimensions less than 0.0100" (.254mm) might not always be feasible for all GS1 DataBar coupon barcodes due to variables, such as printing process, symbol orientation, and material. Due to the time sensitive nature of the coupon printing process, these variables should be considered during the design and barcode origination processes. Barcode verification should always be done from printing press proofs.</p>



Note: See section [2.7](#) to ensure the correct symbol specification table is used.

In addition to the symbol used at general retail POS, an additional 2D symbol may be used to carry AI (8200). As AI (8200) has a mandatory association with GTIN, the GTIN within the symbol ensures compatibility with direct or indirect mode. GS1 DataMatrix is approved for all applications including regulated healthcare trade items covered by SSTs 6, 7, 8, and 10, but for general retail consumer trade items, either GS1 QR Code or GS1 DataMatrix are GS1 approved options. When using 2D symbols to carry AI (8200) on general retail trade items, the following specifications are required.

Figure 5.5.2.7.1-2. GS1 system symbol specification table 1 addendum for AI (8200)

Symbol(s) specified (**)	X-dimension mm (inches)			Minimum symbol height for given X mm (inches)			Quiet Zone Surrounding Symbol	Minimum quality specification
	Minimum	Target	Maximum	For minimum X-dimension	For target X-dimension	For maximum X-dimension		
GS1 DataMatrix (ECC 200) (*)	0.396 (0.0150")	0.495 (0.0195")	0.743 (0.0293")	Height is determined by X-dimension and data that is encoded			1X on all four sides	1.5/12/660
GS1 QR Code (*)	0.396 (0.0150")	0.495 (0.0195")	0.743 (0.0293")	Height is determined by X-dimension and data that is encoded			4X on all four sides	1.5/12/660

(*)	2D X-dimension - Optical effects in the image capture process require that the GS1 DataMatrix and GS1 QR Code symbols be printed at 1.5 times the equivalent X-dimension allowed for linear symbols.
(**)	Where a linear symbol appears on the package, reverse and mirror-image representation of GS1 2D symbols SHALL NOT be permitted.

5.5.2.7.2 Symbol specification table 2 - Trade items scanned in general distribution only

Figure 5.5.2.7.2-1. GS1 system symbol specification table 2

Symbol(s) specified	(*) X-dimension mm (inches)			(**) Minimum symbol height for given X mm (inches)			Quiet Zone		(***) Minimum quality specification
	Minimum	Target	Maximum	For minimum X-dimension	For target X-dimension	For maximum X-dimension	Left	Right	
EAN-13	0.495 (0.0195")	0.660 (0.0260")	0.660 (0.0260")	34.28 (1.350")	45.70 (1.800")	45.70 (1.800")	11X	7X	1.5/10/660
EAN-8	0.495 (0.0195")	0.660 (0.0260")	0.660 (0.0260")	27.35 (1.077")	36.46 (1.435")	36.46 (1.435")	7X	7X	1.5/10/660
UPC-A	0.495 (0.0195")	0.660 (0.0260")	0.660 (0.0260")	34.28 (1.350")	45.70 (1.800")	45.70 (1.800")	9X	9X	1.5/10/660
UPC-E	0.495 (0.0195")	0.660 (0.0260")	0.660 (0.0260")	34.28 (1.350")	45.70 (1.800")	45.70 (1.800")	9X	7X	1.5/10/660
ITF-14	0.495 (0.0195")	0.495 (0.0195")	1.016 (0.0400")	31.75 (1.250")	31.75 (1.250")	31.75 (1.250")	10X	10X	1.5/10/660
GS1-128	0.495 (0.0195")	0.495 (0.0195")	1.016 (0.0400")	31.75 (1.250")	31.75 (1.250")	31.75 (1.250")	10X	10X	1.5/10/660
GS1 DataBar Omni-directional	0.495 (0.0195")	0.660 (0.0260")	0.660 (0.0260")	16.34 (0.644")	21.78 (0.858")	21.78 (0.858")	NA	NA	1.5/10/660
GS1 DataBar Stacked Omni-directional	0.495 (0.0195")	0.660 (0.0260")	0.660 (0.0260")	34.16 (1.346")	45.54 (1.794")	45.54 (1.794")	NA	NA	1.5/10/660
GS1 DataBar Expanded	0.495 (0.0195")	0.660 (0.0260")	0.660 (0.0260")	16.83 (0.663")	22.44 (0.884")	22.44 (0.884")	NA	NA	1.5/10/660
GS1 DataBar Expanded Stacked	0.495 (0.0195")	0.660 (0.0260")	0.660 (0.0260")	35.15 (1.385")	46.86 (1.846")	46.86 (1.846")	NA	NA	1.5/10/660
GS1 DataBar Stacked	0.495 (0.0195")	0.660 (0.0260")	0.660 (0.0260")	6.44 (0.254")	8.58 (0.338")	8.58 (0.338")	NA	NA	1.5/10/660
GS1 DataBar Limited	0.495 (0.0195")	0.660 (0.0260")	0.660 (0.0260")	4.95 (0.195")	6.60 (0.260")	6.60 (0.260")	NA	NA	1.5/10/660
GS1 DataBar Truncated	0.495 (0.0195")	0.660 (0.0260")	0.660 (0.0260")	6.44 (0.254")	8.58 (0.338")	8.58 (0.338")	NA	NA	1.5/10/660

(*) UPC-E and EAN-8 symbols are designed for use on small packages. Whenever space permits, UPC-A, EAN-13, ITF-14, or GS1-128 symbols SHOULD be used in the General distribution scanning environment.

The minimum symbol height dimensions listed for all symbologies including EAN/UPC symbols do not include the human readable interpretation (or bearer bars for ITF-14 symbols). The minimum heights of EAN/UPC symbols do not include the extended bars: see section 5.2.1.4.2 for dimensions of the extended bars. Because of the operative scanning environment for EAN/UPC symbols, there is a direct relationship between the symbol's height and width. This means the minimum symbol height is tied to the minimum, target, and maximum X-dimension listed.

ITF-14 symbols with X-dimensions below 0.635 millimetre (0.0250 inch) SHOULD NOT be printed directly on corrugate with conventional (plate-based) processes. The ITF-14 symbol's bar width ratio target is 2.5:1, and the acceptable range is 2.25:1 to 3:1.

GS1-128 symbols have a maximum symbol length of 165.10 millimetres (6.500 inch), which may impact the maximum achievable X-dimension. For example, a GS1-128 symbol containing an SSCC has a maximum achievable X-dimension for 0.940 millimetre (0.0370 inch)

For GS1-128 and ITF-14, a smaller X-Dimension may be used if there is absolutely no possibility of printing the full size barcode because the trade item is physically too small; the X-Dimension SHALL NOT be less than 0.250 millimetre (0.0098 inch). For details on barcode production and quality assessment see section [5.5](#).

(**) For GS1-128 and ITF-14 symbols the minimum symbol height for General distribution scanning is always 31.75 millimetres (1.250 inch). The minimum symbol height dimensions relate to the bar heights only (do not include human readable interpretation text or ITF-14 symbol bearer bars).

If the trade item is physically too small to accommodate the minimum, for GS1-128 and ITF-14 the minimum height can be reduced to 12.70 millimetres (0.500 inch) or in case of further space constraints to no less than 5.08 millimetres (0.200 inch). For details on barcode production and quality assessment see section [5.5](#).

There is no maximum for the height, but if the maximum X-dimension is used, the symbol height must be equal to or greater than those listed in the Minimum Symbol Height column.

(***) For ITF-14 symbols printed on labels with off-set, thermal, or laser print with an X-dimension 0.495 millimetre (0.0195 inch), the minimum quality specification is 1.5/10/660. For ITF-14 symbols printed directly on corrugate or labels with an X-dimension greater than or equal to 0.635 millimetre (0.0250 inch), the minimum quality specification is 0.5/20/660.



Note: See section [2.7](#) to ensure the correct symbol specification table is used.

5.5.2.7.3 Symbol specification table 3 - Trade items scanned at general retail POS and general distribution

Figure 5.5.2.7.3-1. GS1 system symbol specification table 3

Symbol(s) specified	(*) X-dimension mm (inches)			(**) Minimum symbol height for given X mm (inches)			Quiet Zone		Minimum quality specification
	Minimum	Target	Maximum	For minimum X-dimension	For target X-dimension	For maximum X-dimension	Left	Right	
EAN-13	0.495 (0.0195")	0.660 (0.0260")	0.660 (0.0260")	34.28 (1.350")	45.70 (1.800")	45.70 (1.800")	11X	7X	1.5/06/660
EAN-8	0.495 (0.0195")	0.660 (0.0260")	0.660 (0.0260")	27.35 (1.077")	36.46 (1.435")	36.46 (1.435")	7X	7X	1.5/06/660
UPC-A	0.495 (0.0195")	0.660 (0.0260")	0.660 (0.0260")	34.28 (1.350")	45.70 (1.800")	45.70 (1.800")	9X	9X	1.5/06/660
UPC-E	0.495 (0.0195")	0.660 (0.0260")	0.660 (0.0260")	34.28 (1.350")	45.70 (1.800")	45.70 (1.800")	9X	7X	1.5/06/660
GS1 DataBar Omni-directional (***)	0.495 (0.0195")	0.660 (0.0260")	0.660 (0.0260")	22.77 (0.897")	30.36 (1.196")	30.36 (1.196")	None	None	1.5/06/660
GS1 DataBar Stacked Omni-directional (***)	0.495 (0.0195")	0.660 (0.0260")	0.660 (0.0260")	47.03 (1.853")	62.70 (2.470")	62.70 (2.470")	None	None	1.5/06/660
GS1 DataBar Expanded	0.495 (0.0195")	0.660 (0.0260")	0.660 (0.0260")	16.83 (0.663")	22.44 (0.884")	22.44 (0.884")	None	None	1.5/06/660
GS1 DataBar Expanded Stacked	0.495 (0.0195")	0.660 (0.0260")	0.660 (0.0260")	35.15 (1.385")	46.86 (1.846")	46.86 (1.846")	None	None	1.5/06/660

- (*) UPC-E and EAN-8 symbols are designed for use on small packages. Whenever space permits, UPC-A and EAN-13 symbols SHOULD be used.
- (**) The minimum symbol height dimensions listed for all symbologies including EAN/UPC symbols do not include the human readable interpretation. The minimum heights of EAN/UPC symbols do not include the extended bars: see section [5.2.1.4.2](#) for dimensions of the extended bars. Because of the operative scanning environment for EAN/UPC symbols, there is a direct relationship between the symbol's height and width. This means the minimum symbol height listed is tied to the minimum, target, and maximum X-dimension listed. There is no maximum for the height, but if the maximum X-dimension is used, the symbol height must be equal to or greater than those listed in the Minimum Symbol Height column.
- (***) The current symbol specification for GS1 DataBar Omnidirectional (minimum height 33X) and GS1 DataBar Stacked Omnidirectional (minimum height 69X) indicate a square aspect ratio for the symbol segments. To enhance scanning performance, in an omnidirectional scanning environment, an over square aspect ratio SHALL be used following the example of the EAN/UPC symbology specification and rigorous field test of the GS1 DataBar symbology (46X or 95X).



Note: See section [2.7](#) to ensure the correct symbol specification table is used.

5.5.2.7.4 Symbol specification table 4 – Trade items not scanned at POS or general retail - also not scanned in general distribution or regulated healthcare (retail or non-retail)

Figure 5.5.2.7.4-1. GS1 system symbol specification table 4

Symbol(s) specified	(*) X-dimension mm (inches)			(**) Minimum symbol height for given X mm (inches)			Quiet Zone		Minimum quality specification
	Minimum	Target	Maximum	For minimum X-dimension	For target X-dimension	For maximum X-dimension	Left	Right	
EAN-13	0.264 (0.0104")	0.330 (0.0130")	0.660 (0.0260")	18.28 (0.720")	22.85 (0.900")	45.70 (1.800")	11X	7X	1.5/06/660
EAN-8	0.264 (0.0104")	0.330 (0.0130")	0.660 (0.0260")	14.58 (0.574")	18.23 (0.718")	36.46 (1.435")	7X	7X	1.5/06/660
UPC-A	0.264 (0.0104")	0.330 (0.0130")	0.660 (0.0260")	18.28 (0.720")	22.85 (0.900")	45.70 (1.800")	9X	9X	1.5/06/660
UPC-E	0.264 (0.0104")	0.330 (0.0130")	0.660 (0.0260")	18.28 (0.720")	22.85 (0.900")	45.70 (1.800")	9X	7X	1.5/06/660
GS1 DataBar Omni-directional	0.264 (0.0104")	0.330 (0.0130")	0.660 (0.0260")	8.71 (0.343")	10.90 (0.429")	21.78 (0.858")	NA	NA	1.5/06/660
GS1 DataBar Stacked Omni-directional	0.264 (0.0104")	0.330 (0.0130")	0.660 (0.0260")	18.24 (0.718")	27.78 (1.094")	45.54 (1.794")	NA	NA	1.5/06/660
GS1 DataBar Expanded	0.264 (0.0104")	0.330 (0.0130")	0.660 (0.0260")	8.99 (0.354")	11.23 (0.442")	22.44 (0.883")	NA	NA	1.5/06/660
GS1 DataBar Expanded Stacked	0.264 (0.0104")	0.330 (0.0130")	0.660 (0.0260")	18.75 (0.738")	23.44 (0.923")	46.86 (1.845")	NA	NA	1.5/06/660
GS1 DataBar Stacked	0.264 (0.0104")	0.330 (0.0130")	0.660 (0.0260")	3.43 (0.135")	4.29 (0.169")	8.58 (0.338")	N/A	N/A	1.5/06/660
GS1 DataBar Limited	0.264 (0.0104")	0.330 (0.0130")	0.660 (0.0260")	2.64 (0.104")	3.30 (0.130")	6.60 (0.260")	N/A	N/A	1.5/06/660
GS1 DataBar Truncated	0.264 (0.0104")	0.330 (0.0130")	0.660 (0.0260")	3.43 (0.135")	4.29 (0.169")	8.58 (0.338")	N/A	N/A	1.5/06/660
ITF-14	0.250 (0.00984")	0.495 (0.0195")	0.495 (0.0195")	12.70 (0.500")	12.70 (0.500")	12.70 (0.500")	10X	10X	1.5/06/660
GS1-128	0.250 (0.00984")	0.495 (0.0195")	0.495 (0.0195")	12.70 (0.500")	12.70 (0.500")	12.70 (0.500")	10X	10X	1.5/06/660
GS1 DataMatrix (ECC 200) (***)	0.380 (0.0150")	0.380 (0.0150")	0.495 (0.0195")	Height is determined by X-dimension and data that is encoded			1X on all four sides		1.5/08/660
GS1 QR Code (***)	0.380 (0.0150")	0.380 (0.0150")	0.495 (0.0195")	Height is determined by X-dimension and data that is encoded			4X on all four sides		1.5/08/660

(*) ITF-14 symbols with X-dimensions below 0.635 millimetre (0.0250 inch) SHOULD NOT be printed directly on corrugate with conventional (plate based) processes. The ITF-14 symbol's bar width ratio target is 2.5:1, and the acceptable range is 2.25:1 to 3:1.

Section 5.5.3.4 gives full details on when barcodes can be printed at less than the minimum X-dimension. In general, barcodes may only be printed using an X-dimension below 0.264 millimetre (0.0104 inch) or 80 percent magnification under the following conditions:

- The allowance for X-dimensions between 0.249 millimetre (0.0098 inch) or 75 percent magnification and 0.264 millimetre (0.0104 inch) or 80 percent magnification is only applicable to on demand (e.g., thermal, laser) print processes. For all other printing processes, an X-dimension of 0.264 millimetre (0.0104 inch) is attainable and is the minimum allowable size.
- When printing a minimum symbol with any method of printing, the area provided for printing the symbol and the required Quiet Zone should never be less than the area required for an X-dimension of 0.264 millimetre (0.0104 inch).
- When printing a minimum symbol with any method of printing, the symbol height SHALL never be truncated.

- (**) The minimum symbol height dimensions listed for all symbologies including EAN/UPC symbols do not include the human readable interpretation (or bearer bars for ITF-14 symbols), The minimum heights of EAN/UPC symbols do not include the extended bars: see section [5.2.1.4.2](#) for dimensions of the extended bars.
- Because of the operative scanning environment for EAN/UPC symbols, there is a direct relationship between the symbol's height and width. This means the minimum symbol height listed is tied to the minimum, target, and maximum X-dimension listed.
- The minimum bar height for ITF-14 and GS1-128 symbols in this operative scanning environment is 12.70 millimetres (0.500 inch), but if the package is physically too small to accommodate this rule, further truncation is permitted. In no case SHALL the bar height be less than 5.08 millimetres (0.200 inch).
- There is no maximum for the symbol height, but if the maximum X-dimension is used, the symbol height must be equal to or greater than those listed in the Minimum Symbol Height column.
- Whereas, linear symbol heights are set at a fixed dimension, Composite Components are printed at the same X-dimension as the linear portion of the Composite symbology, and the barcode height varies depending on the amount of data, the X-dimension, and which linear symbol is used in conjunction with the Composite Component. Note that Composite Components have to be printed with a linear symbol such as GS1 DataBar, GS1-128, UPC-A, or EAN-13. ITF-14 cannot be used with Composite Components.
- (***) 2D X-dimension - Optical effects in the image capture process require that the GS1 DataMatrix and GS1 QR Code symbols be printed at 1.5 times the equivalent printing X-dimension allowed for linear symbols.



Note: See section [2.7](#) to ensure the correct symbol specification table is used.

5.5.2.7.5 Symbol specification table 5 – logistic units scanned in general distribution

Figure 5.5.2.7.5-1. GS1 system symbol specification table 5

Symbol(s) specified	(*) X-dimension mm (inches)			(**) Minimum symbol height for given X mm (inches)			Quiet Zone		Minimum quality specification
	Minimum	Target	Maximum	For minimum X-dimension	For target X-dimension	For maximum X-dimension	Left	Right	
GS1-128	0.495 (0.0195")	0.495 (0.0195")	0.940 (0.0370")	31.75 (1.250")	31.75 (1.250")	31.75 (1.250")	10X	10X	1.5/10/660

(*) If the logistic unit is physically too small to accommodate the minimum X-dimension, the minimum X-dimension is 0.250 millimetre (0.0098 inch). For details on barcode production and quality assessment see section [5.5](#).

(**) The minimum symbol height indicated is for bar height only and does not include the human readable interpretation.
 If the logistic unit is physically too small to accommodate the minimum, the minimum bar height is the greater of 15 percent of the symbol width including Quiet Zones or 12.70 millimetres (0.500 inch). If the package is physically too small to accommodate this rule, further truncation is permitted, but in no case SHALL the bar height be less than 5.08 millimetres (0.200 inch). For details on barcode production and quality assessment see section [5.5](#).
 There is no maximum for the height, but if the maximum X-dimension is used, the symbol height must be equal to or greater than those listed in the Minimum Symbol Height column.



Note: See section [2.7](#) to ensure the correct symbol specification table is used.

5.5.2.7.6 Symbol specification table 6 - Regulated healthcare non-retail consumer trade items not scanned in general distribution

Figure 5.5.2.7.6-1. GS1 system symbol specification table 6

Symbol(s) specified	X-dimension mm (inches)			Minimum symbol height for given X mm (inches)			Quiet Zone		Minimum quality specification
	Minimum	Target	Maximum	For minimum X-dimension	For target X-dimension	For maximum X-dimension	Left	Right	
GS1- 128	0.170 (0.0067")	0.495 (0.0195")	0.495 (0.0195")	12.70 (0.500")	12.70 (0.500")	12.70 (0.500")	10X	10X	1.5/06/660
GS1 DataMatrix (ECC 200) (*)	0.254 (0.0100")	0.380 (0.0150")	0.495 (0.0195")	Height is determined by X-dimension and data that is encoded			1X on all four sides		1.5/08/660
GS1 DataBar Omni-directional	0.170 (0.0067")	0.200 (0.0080")	0.660 (0.0260")	5.61 (0.221")	6.60 (0.260")	21.78 (0.858")	Not Applicable	Not Applicable	1.5/06/660
GS1 DataBar Truncated	0.170 (0.0067")	0.200 (0.0080")	0.660 (0.0260")	2.21 (0.087")	2.60 (0.102")	8.58 (0.338")	Not Applicable	Not Applicable	1.5/06/660
GS1 DataBar Stacked	0.170 (0.0067")	0.200 (0.0080")	0.660 (0.0260")	2.21 (0.087")	2.60 (0.102")	8.58 (0.338")	Not Applicable	Not Applicable	1.5/06/660
GS1 DataBar Stacked Omni-directional	0.170 (0.0067")	0.200 (0.0080")	0.660 (0.0260")	11.73 (0.462")	13.80 (0.543")	45.54 (1.794")	Not Applicable	Not Applicable	1.5/06/660
GS1 DataBar Limited	0.170 (0.0067")	0.200 (0.0080")	0.660 (0.0260")	1.70 (0.067")	2.00 (0.079")	6.60 (0.260")	Not Applicable	Not Applicable	1.5/06/660
GS1 DataBar Expanded	0.170 (0.0067")	0.200 (0.0080")	0.660 (0.0260")	5.78 (0.228")	6.80 (0.268")	22.44 (0.884")	Not Applicable	Not Applicable	1.5/06/660
GS1 DataBar Expanded Stacked	0.170 (0.0067")	0.200 (0.0080")	0.660 (0.0260")	12.07 (0.475")	14.20 (0.559")	46.86 (1.846")	Not Applicable	Not Applicable	1.5/06/660
EAN-13	0.170 (0.0067")	0.330 (0.0130")	0.660 (0.0260")	18.28 (0.720")	22.85 (0.900")	45.70 (1.800")	11X	7X	1.5/06/660
EAN-8	0.170 (0.0067")	0.330 (0.0130")	0.660 (0.0260")	14.58 (0.574")	18.23 (0.718")	36.46 (1.435")	7X	7X	1.5/06/660
UPC-A	0.170 (0.0067")	0.330 (0.0130")	0.660 (0.0260")	18.28 (0.720")	22.85 (0.900")	45.70 (1.800")	9X	9X	1.5/06/660
UPC-E	0.170 (0.0067")	0.330 (0.0130")	0.660 (0.0260")	18.28 (0.720")	22.85 (0.900")	45.70 (1.800")	9X	7X	1.5/06/660
ITF-14	0.170 (0.0067")	0.495 (0.0195")	0.495 (0.0195")	12.70 (0.500")	12.70 (0.500")	12.70 (0.500")	10X	10X	1.5/06/660
CC-A	All CCs need to be printed at the same X-dimensions as their linear components, therefore consult the appropriate row and column for the linear symbol to be used.			Height is determined by X-dimension and data that is encoded			1X	1X	1.5/06/660
CC-B							1X	1X	1.5/06/660
CC-C							2X	2X	1.5/06/660

(*) 2D X-dimension - Optical effects in the image capture process require that the GS1 DataMatrix symbol be printed at 1.5 times the equivalent printing X-dimension allowed for linear or Composite symbols.



Note: See section [2.7](#) to ensure the correct symbol specification table is used.



Note: This table contains several symbol options. All are permitted to promote backward compatibility, but section 2 application standards define which symbols are the preferred options for the future.

5.5.2.7.7 Symbol specification table 7 - Direct part marking

Figure 5.5.2.7.7-1. GS1 system symbol specification table 7

Symbol(s) specified	X-dimension mm (inches) Note 1 Note 4			Minimum symbol height for given X mm (inches)	Quiet Zone	Minimum quality specification	
	Minimum	Target	Maximum				
GS1 DataMatrix	0.254 (0.0100")	0.300 (0.0118")	0.615 (0.0242")	Height is determined by X-dimension and data that is encoded	1X on all four sides	1.5/06/660 Note 3	For direct marking of items other than medical devices
GS1 QR Code	0.254 (0.0100")	0.300 (0.0118")	0.615 (0.0242")	Height is determined by X-dimension and data that is encoded	4X on all four sides	1.5/06/660 Note 3	For direct marking of items other than medical devices
GS1 DataMatrix Ink Based direct part marking	0.254 (0.0100")	0.300 (0.0118")	0.615 (0.0242")	Height is determined by X-dimension and data that is encoded	1X on all four sides	1.5/08/660 Note 3	For direct marking of medical devices such as small medical / surgical instruments
GS1 DataMatrix direct part marking - A Note 2	0.100 (0.0039")	0.200 (0.0079")	0.300 (0.0118")	Height is determined by X-dimension and data that is encoded	1X on all four sides	DPM1.5/04-12/650/(45Q 30Q 30T 30S 90) Note 5	For direct marking of medical devices such as small medical / surgical instruments
GS1 DataMatrix direct part marking - B Note 2	0.200 (0.0079")	0.300 (0.0118")	0.495 (0.0195")	Height is determined by X-dimension and data that is encoded	1X on all four sides	DPM1.5/08-20/650/(45Q 30Q 30T 30S 90) Note 5	For direct marking of small medical / surgical instruments



Note: The largest X-dimension in a given range that will allow a symbol with the needed data content to fit within the available marking area should be used to maximise marking and reading performance (depth of field, tolerance to curvature, etc.).

The angle is an additional parameter defining the angle of incidence (relative to the plane of the symbol) of the illumination for direct part marking verification. It SHALL be included in the overall symbol grade when the angle of incidence is other than 45 degrees. Its absence indicates that the angle of incidence is 45 degrees. See ISO/IEC 15415 and ISO/IEC TR 29158 (AIM DPM).

In small instrument marking, mixed marking technologies used within the same scanning environment should be avoided to ensure highest reading performance. Laser etching is recommended for small instrument marking.



Note 1: Optical effects in the image capture process require that label based GS1 DataMatrix and GS1 QR Code symbols be printed at approximately 1.5 times the equivalent X-dimension allowed for linear symbols in the same application.



Note 2: There are two basic types of non ink based direct part marks, those with "connected modules" in the "L" shaped finder pattern (GS1 DataMatrix direct part marking – A) created by DPM marking technologies such as laser or chemical etching and those with "non connected modules" in the "L" shaped finder pattern (GS1 DataMatrix direct part marking – B) created by DPM marking technologies such as dot peen. Due to the marking technologies and characteristics of reading they each have varied ranges of X-dimensions and different quality criteria recommended and may require different reading equipment.

GS1 DataMatrix – A is suggested for marking of medical devices such as small medical / surgical instruments. The Minimum X-dimension of 0.100mm is based upon the specific need for permanence in direct marking of small medical instruments which have limited marking area available on the instrument with a target useable area of 2.5mm x 2.5mm and a data content of GTIN (AI 01) plus serial number (AI 21).

- ✓ **Note 3:** The effective aperture for GS1 DataMatrix and GS1 QR Code quality measurements SHOULD be taken at 80 percent of the minimum X-dimension allowed for the application. For direct part marking - A this would equate to an aperture of 3; for direct part marking - B this would equate to an aperture of 6 and for general healthcare label printing, an aperture of 8. See *ISO/IEC 15415* and *ISO/IEC TR 29158*.
- ✓ **Note 4:** In practical application, where very small symbol sizes are needed, it may be necessary to work with GS1 DataMatrix module X-dimensions smaller than those suggested. Where dimensional restrictions prohibit the application of a full size code, reduced X-dimension AIDC marking is encouraged to facilitate information capture. It should be noted that these practices may limit the symbol effectiveness, including but not limited to:
- the effect of smaller X-dimensions on reading performance,
 - the need for, and limited availability of, special scanners/imagers for reading,
 - special processes for marking,
 - the overall cost considerations.
- These smaller X-dimensions should therefore only be used internally or by mutual agreement between trading partners
- ✓ **Note 5:** Any "Type A" mark that meets the grade requirements under the quality techniques specified in *ISO/IEC 15415* is considered acceptable. If the letters "DPM" precede the grade it indicates that the grade was obtained by following *ISO/IEC TR 29158* (AIM DPM) and not *ISO/IEC 15415* whether "Type A" or "Type B".

5.5.2.7.8 Symbol specification table 8 - Trade items scanned in retail pharmacy and general distribution or non-retail pharmacy and general distribution

Figure 5.5.2.7.8-1. GS1 system symbol specification table 8

Symbol(s) specified	X-dimension mm (inches)			Minimum symbol height for given X mm (inches)			Quiet Zone		Minimum quality specification
	Minimum	Target	Maximum	For minimum X-dimension	For target X-dimension	For maximum X-dimension	Left	Right	
GS1- 128	0.495 (0.0195")	0.495 (0.0195")	1.016 (0.0400")	31.75 (1.250")	31.75 (1.250")	31.75 (1.250")	10X	10X	1.5/10/660
GS1 DataMatrix (ECC 200) (*)	0.750 (0.0300")	0.750 (0.0300")	1.520 (0.0600")	Height is determined by X-dimension and data that is encoded			1X on all four sides		1.5/20/660
EAN-13	0.495 (0.0195")	0.660 (0.0260")	0.660 (0.0260")	34.28 (1.350")	45.70 (1.800")	45.70 (1.800")	11X	7X	1.5/10/660
EAN-8	0.495 (0.0195")	0.660 (0.0260")	0.660 (0.0260")	27.35 (1.077")	36.46 (1.435")	36.46 (1.435")	7X	7X	1.5/10/660
UPC-A	0.495 (0.0195")	0.660 (0.0260")	0.660 (0.0260")	34.28 (1.350")	45.70 (1.800")	45.70 (1.800")	9X	9X	1.5/10/660
UPC-E	0.495 (0.0195")	0.660 (0.0260")	0.660 (0.0260")	34.28 (1.350")	45.70 (1.800")	45.70 (1.800")	9X	7X	1.5/10/660
ITF-14	0.495 (0.0195")	0.495 (0.0195")	1.016 (0.0400")	31.75 (1.250")	31.75 (1.250")	31.75 (1.250")	10X	10X	1.5/10/660
GS1 DataBar Omni-directional	0.495 (0.0195")	0.660 (0.0260")	0.660 (0.0260")	16.34 (0.644")	21.78 (0.858")	21.78 (0.858")	Not Applicable	Not Applicable	1.5/10/660
GS1 DataBar Truncated	0.495 (0.0195")	0.660 (0.0260")	0.660 (0.0260")	6.44 (0.254")	8.58 (0.338")	8.58 (0.338")	Not Applicable	Not Applicable	1.5/10/660
GS1 DataBar Stacked	0.495 (0.0195")	0.660 (0.0260")	0.660 (0.0260")	6.44 (0.254")	8.58 (0.338")	8.58 (0.338")	Not Applicable	Not Applicable	1.5/10/660
GS1 DataBar Stacked Omni-directional	0.495 (0.0195")	0.660 (0.0260")	0.660 (0.0260")	34.16 (1.346")	45.54 (1.794")	45.54 (1.794")	Not Applicable	Not Applicable	1.5/10/660
GS1 DataBar Limited	0.495 (0.0195")	0.660 (0.0260")	0.660 (0.0260")	4.95 (0.195")	6.60 (0.260")	6.60 (0.260")	Not Applicable	Not Applicable	1.5/10/660
GS1 DataBar Expanded	0.495 (0.0195")	0.660 (0.0260")	0.660 (0.0260")	16.83 (0.663")	22.44 (0.884")	22.44 (0.884")	Not Applicable	Not Applicable	1.5/10/660
GS1 DataBar Expanded Stacked	0.495 (0.0195")	0.660 (0.0260")	0.660 (0.0260")	35.15 (1.385")	46.86 (1.846")	46.86 (1.846")	Not Applicable	Not Applicable	1.5/10/660
CC-A	All CCs need to be printed at the same X- dimensions as their linear components, therefore consult the appropriate row and column for the linear symbol to be used.			Height is determined by X-dimension and data that is encoded			1X	1X	1.5/10/660
CC-B							1X	1X	1.5/10/660
CC-C							2X	2X	1.5/10/660

(*) 2D X-dimension - Optical effects in the image capture process require that the GS1 DataMatrix and GS1 QR Code symbols be printed at 1.5 times the equivalent printing X-dimension allowed for linear symbols.

- ✔ **Note:** See section [2.7](#) to ensure the correct symbol specification table is used.
- ✔ **Note:** This table contains several symbol options. All are permitted to promote backward compatibility, but section 2 application standards define which symbols are the preferred options for the future.
- ✔ **Note:** Since June 2007 GS1 has recommended all trading partners in the healthcare sector invest exclusively in imaging-based scanners. Now that GS1 DataMatrix has been approved



within the standard, it is important to inform all trading partners of a process within GS1 to establish target deployment dates. Without these dates, brand owners do not have a way to know when to deploy GS1 DataMatrix on their packaging and those needing to invest in scanning equipment may inadvertently purchase equipment that will not support the standards. To see GS1 healthcare’s position paper on GS1 DataMatrix adoption, visit <http://www.gs1.org/healthcare>.

5.5.2.7.9 Symbol specification table 9 - GS1 keys GDTI, GRAI, GIAI and GLN

Figure 5.5.2.7.9-1. GS1 system symbol specification table 9

Symbol(s) specified	X-dimensions mm(inches)			Minimum symbol height for given X mm(inches)			Quiet Zone		Minimum quality specification
	Minimum	Target	Maximum	For minimum X-dimension	For target X-dimension	For maximum X-dimension	Left	Right	
GS1- 128	0.250 (0.0098")	0.250 (0.0098")	0.495 (0.0195")	12.70 (0.500")	12.70 (0.500")	12.70 (0.500")	10X	10X	1.5/06/660
GS1 DataMatrix (ECC 200) (*)	0.380 (0.0150")	0.380 (0.0150")	0.495 (0.0195")	Height is determined by X-dimension and data that is encoded			1X on all four sides		1.5/08/660
GS1 QR Code (*)	0.380 (0.0150")	0.380 (0.0150")	0.495 (0.0195")	Height is determined by X-dimension and data that is encoded			4X on all four sides		1.5/08/660

(*) 2D X-dimension - Optical effects in the image capture process require that the GS1 DataMatrix and GS1 QR Code symbols be printed at 1.5 times the equivalent printing X-dimension allowed for linear symbols.

- 
Note: See section [2.7](#) to ensure the correct symbol specification table is used.
- 
Note: This table contains several symbol options. All are permitted to promote backward compatibility, but section 2 application standards define which symbols are the preferred options for the future.
- 
Note: For location marking, barcodes may be printed at a higher maximum X-dimension: GS1-128 at 1.016 mm (0.0400 inches), GS1 DataMatrix and GS1 QR Code at 1.520 mm (0.0600 inches). See section [2.4.3.1](#).



5.5.2.7.10 Symbol specification table 10 – Regulated healthcare retail consumer trade items not scanned in general distribution



Figure 5.5.2.7.10-1. GS1 system symbol specification table 10

Symbol(s) specified	X-dimension mm (inches)			Minimum symbol height for given X mm (inches)			Quiet Zone		Minimum quality specification
	Minimum (*)	Target	Maximum	For minimum X-dimension	For target X-dimension	For maximum X-dimension	Left	Right	
GS1- 128	0.264 (0.0104")	0.330 (0.0130")	0.660 (0.0260")	12.70 (0.500")	12.70 (0.500")	12.70 (0.500")	10X	10X	1.5/06/660
GS1 DataMatrix (ECC 200) (**)	0.396 (0.0156")	0.495 (0.0195")	0.990 (0.0390")	Height is determined by X-dimension and data that is encoded			1X on all four sides		1.5/08/660
GS1 DataBar Omnidirectional	0.264 (0.0104")	0.330 (0.0130")	0.660 (0.0260")	8.71 (0.343")	10.89 (0.429")	21.78 (0.858)	Not Applicable	Not Applicable	1.5/06/660
GS1 DataBar Truncated	0.264 (0.0104")	0.330 (0.0130")	0.660 (0.0260")	3.43 (0.135")	4.29 (0.169")	8.58 (0.338")	Not Applicable	Not Applicable	1.5/06/660
GS1 DataBar Stacked	0.264 (0.0104")	0.330 (0.0130")	0.660 (0.0260")	3.43 (0.135")	4.29 (0.169")	8.58 (0.338")	Not Applicable	Not Applicable	1.5/06/660
GS1 DataBar Stacked Omnidirectional	0.264 (0.0104")	0.330 (0.0130")	0.660 (0.0260")	18.22 (0.718")	27.77 (0.897")	45.54 (1.794")	Not Applicable	Not Applicable	1.5/06/660
GS1 DataBar Limited	0.264 (0.0104")	0.330 (0.0130")	0.660 (0.0260")	2.64 (0.104")	3.30 (0.130")	6.60 (0.260")	Not Applicable	Not Applicable	1.5/06/660
GS1 DataBar Expanded	0.264 (0.0104")	0.330 (0.0130")	0.660 (0.0260")	8.98 (0.354")	11.22 (0.442")	22.44 (0.883")	Not Applicable	Not Applicable	1.5/06/660
GS1 DataBar Expanded Stacked	0.264 (0.0104")	0.330 (0.0130")	0.660 (0.0260")	18.74 (0.738")	23.43 (0.923")	46.86 (1.846")	Not Applicable	Not Applicable	1.5/06/660
EAN-13	0.264 (0.0104")	0.330 (0.0130")	0.660 (0.0260")	18.28 (0.720")	22.85 (0.900")	45.70 (1.800")	11X	7X	1.5/06/660
EAN-8	0.264 (0.0104")	0.330 (0.0130")	0.660 (0.0260")	14.58 (0.574")	18.23 (0.718")	36.46 (1.435")	7X	7X	1.5/06/660
UPC-A	0.264 (0.0104")	0.330 (0.0130")	0.660 (0.0260")	18.28 (0.720")	22.85 (0.900")	45.70 (1.800")	9X	9X	1.5/06/660
UPC-E	0.264 (0.0104")	0.330 (0.0130")	0.660 (0.0260")	18.28 (0.720")	22.85 (0.900")	45.70 (1.800")	9X	7X	1.5/06/660
ITF-14	0.264 (0.0104")	0.330 (0.0130")	0.660 (0.0260")	12.70 (0.500")	12.70 (0.500")	12.70 (0.500")	10X	10X	1.5/06/660
CC-A	All CCs need to be printed at the same X- dimensions as their linear components, therefore consult the appropriate row and column for the linear symbol to be used.			Height is determined by X-dimension and data that is encoded			1X	1X	1.5/06/660
CC-B							1X	1X	
CC-C							2X	2X	

(*) These barcodes may only be printed using an X-dimension below 0.264 millimetre (0.0104 inch) under the following conditions:

- The allowance for X-dimensions between 0.249 millimetre (0.0098 inch) and 0.264 millimetre (0.0104 inch) is only applicable to on demand (e.g., thermal, laser) print processes. For all other printing processes, an X-dimension of 0.264 millimetre (0.0104 inch) is attainable and is the minimum allowable size.
- When printing a minimum symbol with any method of printing, the area provided for printing the symbol and the required Quiet Zone SHOULD never be less than the area required for an X-dimension of 0.264 millimetre (0.0104 inch).
- When printing a minimum symbol with any method of printing, the symbol height SHALL never be truncated below the minimum.

(**) 2D X-dimension - Optical effects in the image capture process require that the GS1 DataMatrix and GS1 QR Code symbols be printed at 1.5 times the equivalent printing X-dimension allowed for linear symbols.



- 
Note: See section [2.7](#) to ensure the correct symbol specification table is used.
- 
Note: Since June 2007 GS1 has recommended all trading partners in the healthcare sector invest exclusively in imaging-based scanners. Now that GS1 DataMatrix has been approved within the standard, it is important to inform all trading partners of a process within GS1 to establish target deployment dates. Without these dates, brand owners do not have a way to know when to deploy GS1 DataMatrix on their packaging and those needing to invest in scanning equipment may inadvertently purchase equipment that will not support the standards. To see GS1 Healthcare’s Position Paper on GS1 DataMatrix adoption, visit GS1.org/GS1Healthcare.

5.5.2.7.11 Symbol specification table 11 – GS1 GSRNs

Figure 5.5.2.7.11-1. GS1 system symbol specification table 11

Symbol(s) specified	X-dimensions mm(inches)			Minimum symbol height for given X mm(inches)			Quiet Zone		Minimum quality specification
	Minimum	Target	Maximum	For minimum X-dimension	For target X-dimension	For maximum X-dimension	Left	Right	
GS1- 128	0.170 (0.0067")	0.250 (0.0098")	0.495 (0.0195")	12.70 (0.500")	12.70 (0.500")	12.70 (0.500")	10X	10X	1.5/05/660
GS1 DataMatrix (ECC 200) (*)	0.254 (0.0100")	0.380 (0.0150")	0.495 (0.0195")	Height is determined by X-dimension and data that is encoded			1X on all four sides		1.5/08/660
GS1 QR Code (*)	0.254 (0.0100")	0.380 (0.0150")	0.495 (0.0195")	Height is determined by X-dimension and data that is encoded			4X on all four sides		1.5/08/660

(*) 2D X-dimension - Optical effects in the image capture process require that the GS1 DataMatrix and GS1 QR Code symbols be printed at 1.5 times the equivalent printing X-dimension allowed for linear symbols.

- 
Note: See section [2.7](#) to ensure the correct symbol specification table is used.
- 
Note: This table contains several symbol options. All are permitted to promote backward compatibility, but section 2 application standards define which symbols are the preferred options for the future.

5.5.3 Barcode production

The following subsections will:

- Provide background on major barcode printing methods and materials
- Provide general printing and packaging background for major application groups

The various definitions and specialist terms used throughout this section are found in *ISO/IEC 15419, Information Technology, Automatic Identification and Data Capture Techniques, Bar Code Digital Imaging and Printing Performance Testing*, *ISO/IEC 15416, Information technology, Automatic Identification and Data Capture Technologies, Bar Code Print Quality Test Specification – Linear Symbols* and *ISO/IEC 15415, Information technology, Automatic Identification and Data capture Techniques, Bar Code Print Quality Test Specification, Two-dimensional Symbols*.

5.5.3.1 Digital imaging

5.5.3.1.1 General requirements

General requirements consisting of the following topics are found in section 4 of *ISO/IEC 15419*.

- Data input.
- Quiet Zones.
- Classification of imaging device categories, from informative reference Annex E of *ISO/IEC 15419*.
- Programmer's examples, from informative reference Annex F of *ISO/IEC 15419*.
- Programmer's example for general-purpose printers.
- Programmer's example for indirect barcode imaging devices.
- Programmer's example for symbols distorted for plate roll circumference.
- Direct barcode imaging devices.
- Dedicated barcode printers.
- Adjustment of target element dimensions.
- Record of design elements.
- General purpose printers.
- Adjusted bar width compensation (BWC) (including the General Purpose Printer Dot/Pixel Comparison figure).
- Record of design attributes.
- Indirect barcode imaging devices.
- Adjustments for planned distortion (disproportioning).
- Adjustments for special EAN/UPC symbol characters.
- Test requirements:
 - System configuration.
 - Test procedure.
- Conformance.
- Test report, including sample test layout, from normative reference Annex A of *ISO/IEC 15419*
- Certification.
- Software specification, including classification of software categories, from informative reference Annex D of *ISO/IEC 15419* and functions of barcode production software from informative reference Annex G of *ISO/IEC 15419*.
- Maintenance and supplies, from informative reference Annex C of *ISO/IEC 15419*.

5.5.3.1.2 Dedicated barcode printers

Section 5 of *ISO/IEC 15419* contains information on dedicated barcode printers and includes the following topics:

- Data input requirements.
- Test requirements.
- Selection of equipment for testing.
- Test conditions; environment, equipment configuration.
- Test procedure.
- Conformance.
- Test report.
- Certification and labelling.
- Equipment specification.

5.5.3.1.3 EAN/UPC on-demand printed symbols at minimum size

It is more difficult for the user to create high quality barcodes with general-purpose printers than it is with direct thermal transfer label printers. There are two reasons for this difficulty. First, the printed dot size for general-purpose printers is appreciably larger than the pixel dimension, as shown in the figure below. This causes the bars (dark bars) to be printed wider and the spaces (light bars) to be narrower than nominal, unless the software driving the printer corrects for this distortion. Second, the software that constructs the barcode may itself introduce dimensional errors.

Figure 5.5.3.1.3-1. Example of digital printing

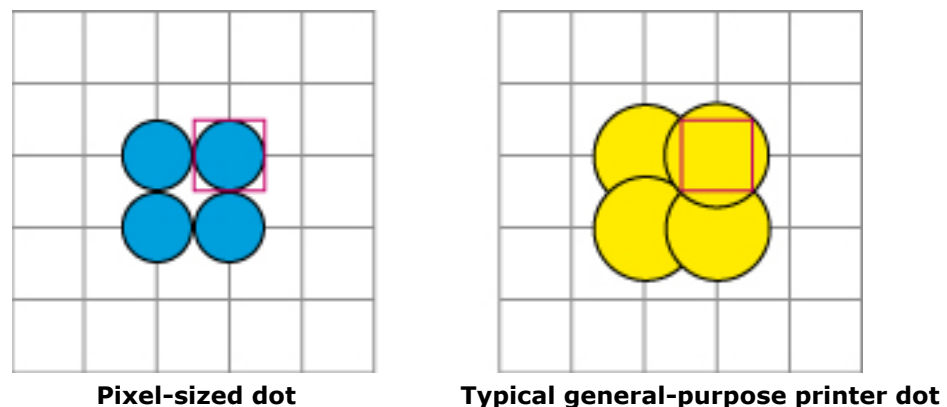

The most common printing densities used by on-demand, barcode printers are 200 and 300 dpi. However, due to the constraints of the dot pitch, these printers cannot print a minimum X-dimension of 0.264 mm (0.0104 inch) or 80 percent magnification symbol correctly. The closest to 80 percent that these printers can print is 75.7 percent or 76.9 percent depending on the exact dot geometry (see figure 5.5.3.1.3-2).

Even though a minimum X-dimension of 0.264 mm (0.0104) inch or 80 percent magnification) is the minimum value specified, users of on-demand printers have used magnifications between 75 percent and 80 percent in point-of-sale (POS) scanning environments for years. They have done so with no significant reduction in scan rate, as compared to symbols printed precisely at 80 percent. Because larger in-specification symbols are always easier to scan, 80 percent symbols and larger are preferred. However, when an on-demand printer is required, the 75 to 80 percent symbols are an acceptable alternative given the following qualifications for printing:

- The allowance for symbols from the EAN/UPC symbology family of magnifications from 75 to 80 percent is only applicable to on-demand (e.g., thermal, laser) print processes. For all other printing processes, 80 percent is attainable and is the minimum allowable size.
- When printing a minimum symbol with any method of printing, the area provided for printing the symbol, including the required Quiet Zones, SHOULD never be less than the area required

for an 80 percent symbol. This area is derived from the total width of an 80 percent symbol times its height.

- When printing a minimum symbol with any method of printing, the symbol height SHALL never be truncated below minimum bar height as stated in the symbol specification tables.

Figure 5.5.3.1.3-2. Achievable X-dimensions for thermal printed EAN/UPC symbols

Reference DPI	Actual DPI	Dots per millimetre	Actual dot width (centre point to centre point)		Dots per module width	Module width (X-dimension)		(*) Corrected magnification
			inch	mm		inch	mm	
200	203.2	8	0.004921	0.12500	2	0.0098	0.250	(**) 75.76%
200	203.2	8	0.004921	0.12500	3	0.0148	0.375	113.64%
200	203.2	8	0.004921	0.12500	4	0.0197	0.500	151.52%
200	203.2	8	0.004921	0.12500	5	0.2461	0.625	189.39%
300	304.8	12	0.003281	0.08333	3	0.0098	0.250	(**) 75.76%
300	304.8	12	0.003281	0.08333	4	0.0131	0.333	100.01%
300	304.8	12	0.003281	0.08333	5	0.0164	0.417	126.26%
300	304.8	12	0.003281	0.08333	6	0.0197	0.500	151.52%
300	304.8	12	0.003281	0.08333	7	0.0230	0.583	176.77%
400	406.4	16	0.002461	0.06250	4	0.0098	0.250	(**) 75.76%
400	406.4	16	0.002461	0.06250	5	0.0123	0.312	94.70%
400	406.4	16	0.002461	0.06250	6	0.0148	0.375	113.64%
400	406.4	16	0.002461	0.06250	7	0.0172	0.437	132.58%
400	406.4	16	0.002461	0.06250	8	0.0197	0.500	151.52%
400	406.4	16	0.002461	0.06250	9	0.0221	0.563	170.45%
400	406.4	16	0.002461	0.06250	10	0.0246	0.625	189.39%
600	609.6	24	0.001640	0.04167	6	0.0098	0.250	(**) 75.76%
600	609.6	24	0.001640	0.04167	7	0.0115	0.292	88.38%
600	609.6	24	0.001640	0.04167	8	0.0131	0.333	101.01%
600	609.6	24	0.001640	0.04167	9	0.0148	0.375	113.64%
600	609.6	24	0.001640	0.04167	10	0.0164	0.417	126.26%
600	609.6	24	0.001640	0.04167	11	0.0180	0.458	138.89%
600	609.6	24	0.001640	0.04167	12	0.0197	0.500	151.52%
600	609.6	24	0.001640	0.04167	13	0.0213	0.542	164.14%
600	609.6	24	0.001640	0.04167	14	0.0230	0.583	176.77%
600	609.6	24	0.001640	0.04167	15	0.0246	0.625	189.39%

(*) The nominal EAN/UPC symbol is based on a module width (X-dimension) of either 0.0130 inch or 0.330 millimetre. In North America, long-standing GS1 US specifications set the nominal module size (X-dimension) at 0.0130 inch or 0.330 millimetres. The ISO/IEC specification for EAN/UPC symbols set the nominal module size (X-dimension) at 0.330 millimetre. The international metric nominal is 0.0606 percent smaller than the original inch-based nominal. The data in the right-most column labelled "Corrected Magnification" are based on a nominal module width (X-dimension) of 0.330 millimetre.

(**) See [Figure 5.5.2.7.1-1](#) for when a magnification of less than 80% is acceptable

5.5.3.2 Barcode master image production

5.5.3.2.1 Introduction

For symbols in the EAN/UPC symbology family, the biggest usage of verification has always been in conjunction with printing and production of packaging and labels by means of the conventional or "wet ink" printing processes, such as offset lithography, flexography, and photogravure. A barcode master image is required as part of the production of printing plates for these processes.

The first point at which one might use verification is a printability test before actual production of the symbols, where a printing run including a test symbol is carried out under normal conditions. The test barcode is then verified to characterise the printing process for a particular press and printing substrate. It is necessary to assess how much bar gain (or loss) has occurred and over what range of variation, to decide how much bar width adjustment (BWA) is required. Bar gain will mean that the printed bars are wider than those of the master image, so the master image will need to be adjusted to compensate for this. BWA can be in the form of bar width reduction (BWR), where there is bar gain, or the less common bar width increase (BWI). The required BWA is associated with the X-dimension used. These details are required in order to specify the master image correctly for the barcode origination software.

Figure 5.5.3.2.1-1. Example of bar width adjustment

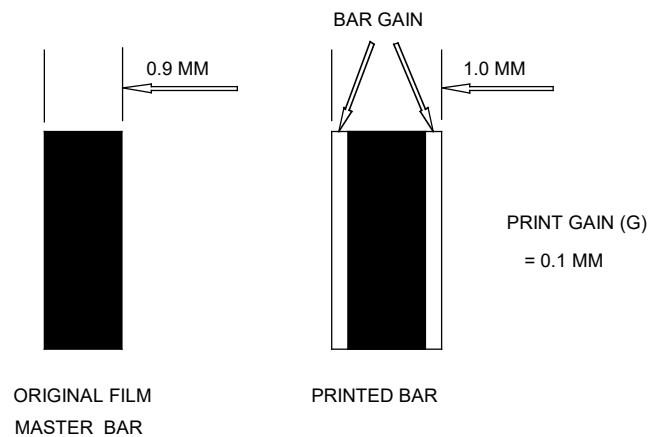

If a proof of the print job is produced, the barcode should be verified as part of the approval process. Note, however, that since proofing presses are not the same as production printing presses, there may be a slight difference in the quality of the proof and the production job.

While the presses are being made ready, a check of bar widths on the first few printed sheets can help to ensure that the press is correctly set to produce near-ideal bar widths. Once the presses have started to roll, periodic sampling should be carried out, at intervals based on experience or dictated by the company's quality control procedures, to monitor both bar widths and other aspects of symbol quality (in particular symbol contrast), since these are the attributes most easily adjusted during the run.

Finally, a further sample should be verified following completion of the print job. The Scan Reflectance Profile (SRP) analysis SHALL be used as the basis for decision making, to ensure that the job has achieved at least the minimum quality grade specified by the customer or based on the application.

The following items are recommended to accompany a master image file:

- X-dimension (magnification factor).
- Selected bar width reduction.
- Product identification, including company name.
- Printing process for which the master image is intended.

- Identification of the master image supplier.
- Date of master image manufacture.

5.5.3.2.2 Master image requirements

The master image must be produced at an appropriate resolution for the hardware device which will produce the physical image of the barcode on paper, photographic film, printing plate or other substrate. The associated software which converts the input data (the master image) into digital instructions to drive the hardware device is equally important. The general principles and requirements that should be followed are explained in ISO/IEC 15419 Information Technology, Automatic Identification and Data Capture Techniques, Bar Code Digital Imaging and Printing Performance. This international standard sets out general principles governing the barcode image generation function in each component, supplemented by more specific details applicable to certain major categories of software and hardware.

The physical requirements for a film master are found in section 6 of *ISO/IEC 15421 Information technology -- Automatic identification and data capture techniques -- Bar code master test specifications*.

5.5.3.3 Quality assessment

5.5.3.3.1 Verification

Verification is the technical process by which a barcode is measured to determine its conformance with the specification for that symbol. Verification is not intended to be used alone as a method for downstream rejection. For example, GS1's advice is to use the *ISO/IEC 15416* or *ISO/IEC 15415* methodologies as the basis to improve overall scanning performance. An ISO/IEC-based verifier is of enormous assistance in diagnosing the problem and providing a standard means of reporting among printing companies and their trading partners.

It is also important to note the difference between a scanner and a verifier. A verifier is a measuring tool by which one can make certain determinations concerning the ability of the symbol to do its job, namely, to carry and deliver data on demand.

When interpreting the results from verification it is also important to remember that:

- Most verifiers do not measure symbol height.
- Without additional software linking the decoded data to a database, the quality and accuracy of the data content of a symbol cannot be confirmed.
- The verifier does not check that the human readable interpretation matches the barcode data (and it is necessary to check that the two correspond, particularly where the barcode generating software does not include human readable interpretation data).
- Because only a sample of the symbols produced are actually verified, the quality of all the symbols in a production batch cannot be guaranteed beyond the statistical confidence limits associated with the sampling rate used.
- Even a perfect symbol at the time of production can be damaged or otherwise affected in its passage through the supply chain (e.g., scratched, frozen, dampened).
- Operator error can cause inconsistent results. Operators should be properly trained and visual checks should be made to confirm verifier results (e.g., where the barcode is expected to get a good result and fails the verifier test, recheck the operation of using the verifier).
- The correct barcode has been printed for the scanning environment of the item (e.g., an ITF-14 symbol SHALL NOT be used on an item intended for retail point-of-sale).

5.5.3.3.1.1 Traditional verification (informative)

Traditional verification methods were introduced in the early to mid-1970s and were based on the measurement of two symbol parameters: print contrast signal (PCS) and the bar width deviation. If the bar (or space) widths were within a defined (but somewhat arbitrary) tolerance, and if PCS was above a defined minimum value, the symbol was regarded as being "in spec."

Initially, none of these measurements were automated, and human factors affected the accuracy and consistency of measurements. Also, checking that the symbol was correctly encoded was a laborious task. However, within a few years, instruments were developed that performed these measurements automatically. These were the first true verifiers that enabled the printer to take steps to produce the symbols as nearly perfectly as this process allowed.

Traditional verification does not necessarily give results that correlate very closely with the actual scanning performance of the symbols. One reason is that the assessment of the symbol gives only a single threshold for acceptability: "Pass" or "Fail." In addition if the assessment is based on a single scan across the symbol, which might be through an exceptionally good or bad section of the symbol, it cannot be guaranteed to be truly representative of its condition.

Measurements of bar gain or loss are less meaningful in the case of certain symbologies, like the EAN/UPC symbology and the GS1-128 barcode, where decoding relies primarily on edge-to-similar-edge distances, which are relatively immune to even substantial amounts of consistent gain or loss across the symbol. These distances are measured from the leading edge of one bar to the leading edge of the next (or from one trailing edge to the next), which tends to move in the same direction if there is bar gain or loss. A more subtle factor is that the method is not standardised, either as to where the dark and light reflectance (or density) measurements are made for the calculation of PCS, or as to how the exact position of an element edge is defined, so that some models of verifier could assess a given symbol as "Pass" whereas others could "Fail" it – a source of potential and, indeed, actual disagreements among suppliers and customers.

5.5.3.3.1.2 ISO/IEC verification

During the 1980s a group of experts from barcode and user industries working on all types of scanning systems determined the factors that most directly affect symbol-scanning performance and resulted in the analysis of the Scan Reflectance Profile (SRP). This methodology was originally known as ANSI verification because it was first described in the United States' standard ANSI X3.182, published in 1990 under the title *Bar Code Print Quality Guidelines*. The method was then defined in a European standard (*EN 1635*), published in 1995, and an international standard (*ISO/IEC 15416*), published in 2000. *ISO/IEC 15416* is the definitive international specification of the ISO/IEC linear barcode verification methodology, and the numeric grading system is used.

The method, as described in the *ISO/IEC 15416* standard, is technically fully compatible with the ANSI X3.182 and *EN 1635* method, so verifiers based on these standards are not obsolete.

ISO/IEC 15415 is the equivalent definitive international standard for two-dimensional barcode symbols, with one methodology applicable to multi-row barcodes and the other to two-dimensional matrix symbols. In addition *ISO/IEC TR 29158 Direct Part Mark (DPM) Quality Guideline* is relevant when assessing the quality of symbols marked directly to the surface of an item.

In simple terms, an ISO/IEC verifier looks at the symbol in exactly the same way a scanner sees it. The ISO/IEC verifier reports its assessment of the symbol quality not as a single pass or fail decision, but as one of a range of four passing grades (from 4 to 1, in order of decreasing quality) or one failing grade (0). This enables an application to set the most appropriate minimum grade for acceptability. It may be noted that the ANSI standard uses the alphabetic scale A to D for passing grades and F for failing symbols, but the grade thresholds are identical.

The relationship between symbol grades measured in this way and the way the symbols behaved when they were scanned was so close that users rapidly came to accept the SRP assessment method for verifying symbols received from their trading partners. Users knew that as long as a symbol achieved grade 1.5 or better it would give them acceptable performance when they had to scan it to capture the encoded data.



Note: The GS1 system requires that the Quiet Zone be a measured parameter for EAN/UPC Symbology, GS1-128 symbols, and ITF-14 symbols per the values expressed in *ISO/IEC 15416*, section 5. For GS1 DataMatrix it is equal to one X-dimension expressed in *ISO/IEC 16022* section 7 and for GS1 QR Code it is equal to four times the X-dimension expressed in *ISO/IEC 18004:2015*.

5.5.3.3.1.3 Types of verifiers

The *ISO/IEC 15426* standard, which is in two parts, defines the test methods and minimum accuracy criteria for verifiers using the methodologies of *ISO/IEC 15416* (for linear barcodes) and *ISO/IEC 15415* (for multi-row barcodes and two-dimensional matrix symbols). *ISO/IEC 15426-1* relates to linear barcode verifiers, and *ISO/IEC 15426-2* to two-dimensional barcode verifiers.

There are many types of verifier that meet the requirements of *ISO/IEC 15426*, some that are used in conjunction with a personal computer with special verification software for the symbol analysis and display/printing of results, while others are integrated stand-alone units. In addition, some verifiers may have interchangeable measuring apertures and light sources to enable measurement of symbols with a wide range of X-dimensions and to meet the illumination needs of differing application standards.

5.5.3.3.2 Measurement methodology

The symbol must be verified in its final configuration wherever possible (e.g., including over-laminate, package material, contents), but if this is not feasible, the following procedure is recommended to allow for the effects of show-through.

Place the symbol to be verified on a flat surface. If the substrate is not opaque (allows light through), perform the verification procedure with the symbol on a dark surface, and then repeat it on a light surface. Take the poorer set of results, unless it is known what type of material is likely to back the symbol in practice, in which case attempt to match it.

5.5.3.3.3 Symbol grading

Symbol Grading for linear symbols consisting of the following topics is found in section 6 of *ISO/IEC 15416*:

- Scan Reflectance Profile (SRP) grading (further explained in normative reference Annex B of *ISO/IEC 15416*).
- Decode.
- Reflectance parameter grading (including the Reflectance Parameter Grading figure).
- Decodability (including the Decodability Grades figure; also covered in normative reference Annex A of *ISO/IEC 15416*).
- Expression of symbol grade.
- Symbol grading process flowchart is available from normative reference Annex C of *ISO/IEC 15416*.
- Guidance on the verification report template is available in section [5.5.3.5](#) Barcode verification template.

Symbol Grading for two dimensional symbols consisting of the following topics can be found in section 5 of *ISO/IEC 15415*:

- Expression of quality grades.
- Overall Symbol Grade.
- Reporting of the Symbol Grade.
- Symbology-specific parameters and values for symbol grading (further explained in normative reference Annex A of *ISO/IEC 15415*).
- Symbology grading flowchart for two-dimensional matrix symbols (further explained in informative reference Annex B of *ISO/IEC 15415*).
- Guidance on selection of grading parameters in application specification available from informative reference Annex D of *ISO/IEC 15415*.

5.5.3.3.4 Substrate characteristics

Substrate characteristics consisting of the following topics are found in the informative reference Annex D of *ISO/IEC 15416* and informative reference Annex E of *ISO/IEC 15415*

- Substrate opacity.
- Gloss.
- Over-laminate.
- Static reflectance measurements.
- Prediction of symbol contrast.
- Prediction of minimum edge contrast ($E_{C_{min}}$) and modulation (MOD).
- Acceptability of measured and derived values.

5.5.3.3.5 Interpretation of the scan reflectance profile and profile grades

Interpretation of the scan reflectance profile (SRP) and profile grades consisting of the following topics is found in the informative reference Annex E of *ISO/IEC 15416* and informative reference Annex C of *ISO/IEC 15415*:

- Significance of SRPs.
- Interpretation of results.
- Matching grades to applications.
- Alphabetic grading.

5.5.3.3.6 Comparison with traditional methodologies

Comparison with traditional methodologies consisting of the following topics is found in the informative reference Annex I of *ISO/IEC 15416*:

- Traditional methodologies.
- Correlation of print contrast signal with symbol contrast measurements.
- Guidance on grading for applications also specifying print contrast signal (PCS).

5.5.3.3.7 Process control requirements

Process control requirement methodologies consisting of the following topics are found in the informative reference Annex J of *ISO/IEC 15416*:

- Process control for repetitive printing.
- Number of scans.
- Bar width deviation.
- Two-width symbologies.
- (n,k) symbologies.
- Average bar gain/loss.

Average bar error is not graded directly, but is used to calculate what fraction of a defined bar tolerance is consumed by the printing process. This traditional bar tolerance calculation differs by symbology and, in the case of the EAN/UPC symbology, it also differs by the X-dimension at which the symbol is printed. Generally a smaller X-dimension yields a smaller tolerance.

5.5.3.3.8 Compliance statement

Verifiers that are suitable for use with the recommendations contained in these *GS1 General Specifications* will often be supplied with a statement that associates the instrument with the following calibration standards:

"GS1 US Calibrated Conformance Standard Test Cards are manufactured to specifications set by GS1 US and in collaboration with the GS1 Barcodes and Identification Technical Group using *ISO/IEC 15416* and/or *ISO/IEC 15415* methodologies and are calibrated using standards traceable to the National Institute of Standards and Technology."

5.5.3.3.9 Calibrated conformance standard test cards

The verifier operator may use a variety of tools and procedures to periodically ensure maintenance of the verifier's calibration. For example, the operator may follow the manufacturer's recommended procedure for set-up, programming (if necessary), normal operational calibration, and use of the verifier prior to performing any tests. Indeed such procedures are considered essential to ensure the consistency of verification results over time.

Some verifier manufacturers may require the operator to utilise a calibration patch designed for use in maintaining instrument calibration. A common form of patch is often referred to as a "reflectance patch," which may be provided with the instrument. It is very important that the manufacturer's instructions are followed carefully and conscientiously to properly calibrate the instrument. An indication of "calibration complete" normally signals successful recalibration of the device. Other manufacturers may require periodic factory calibration of their verifier to maintain proper calibration.

With the increasing use of verifiers as communication tools, all verifiers must be periodically checked for their calibration conformance to a traceable standard (within accuracy and repeatability limits stated by the manufacturer). For this reason, Calibrated Conformance Standard Test Cards are available for the verifier user.

Calibrated conformance standard test cards have been designed for verifiers with 6, 8, 10, and 20 mils apertures, and the following are currently available from your GS1 Member Organisation:

- EAN/UPC Calibrated Conformance Standard Test Card.
- ITF Calibrated Conformance Standard Test Card.
- GS1-128 Calibrated Conformance Standard Test Card.
- GS1 DataBar Calibrated Conformance Standard Test Card.
- GS1 DataMatrix Calibrated Conformance Standard Test Card.

Use of these test cards provide a number of benefits including:

- Validates verifiers for UPC-A, EAN-13, ITF, GS1-128, GS1 DataMatrix and GS1 DataBar symbols. Covers all GS1 symbologies except Composite Component and GS1 QR Code.
- Training tool for operators of verifiers.
- Validates that the verifier is working within its specified tolerances for the symbology selected.

Each test card is designed to test particular characteristics of *ISO/IEC 15416* and *ISO/IEC 15415* - based verification equipment. The standards are manufactured on special materials and are made traceable to the National Institute of Standards and Technology (NIST). This traceability is facilitated through a custom designed piece of hardware (named the "1D Judge®" and "2D Judge®") and has been engineered to measure the various attributes outlined in *ISO/IEC 15416*. The "1D Judge®" and "2D Judge®" have also been made traceable to NIST in Washington, D.C.

The idea behind the standard is to regularly test the verification equipment to ensure it is operating within ISO tolerance levels as published by the verifier manufacturer. This is especially important in heavy use applications where various operators may be involved or where a new user is learning to properly verify. The operator should routinely scan each of the symbols on the test card to determine if the verifier device provides the values listed. These specifications stipulate an aperture and 660 nanometres +/-10 nanometres wavelength be used, and the exact scanning method should be determined by following all of the verifier manufacturer recommendations. This may require some practice to obtain the right touch, but it will inform the operator when the correct method has been used.

If the verifier reports values that agree with the values listed on the test card (within the verifier manufacturer's stated accuracy and repeatability limits), then the operator can assume the verifier is calibrated. If, after repeated attempts, the device does not provide the value as printed on the standard (within the verifier manufacturer's stated accuracy and repeatability limits), then the

device or the operator's scanning technique must be considered suspect. In this event, the operator should refer to his or her operator's manual as to the proper remedies specified by the verifier manufacturer.

Test cards are sensitive and should be handled with care. If the symbols show dirty areas, one can safely clean these by using a soft cotton pad and photographic grade film cleaner. If visible scratches develop on a symbol, that area of the symbol SHALL NOT be used. If sufficient visible scratches develop so that a clean scan path is not available, then the test card is no longer useable and SHALL be replaced.

The test card serves as a device for, or means of, confirming that an ISO-based verifier has been properly calibrated and that users are obtaining results within the accuracy limits stated by the manufacturer of their instruments.

It is possible that a defective verifier, use of a damaged or incorrect reflectance patch, or, in some cases, a careless user performing the calibration to the patch might provide a false indication of successful calibration. The proper use of the Calibrated Conformance Standard Test Cards is the only way multiple trading partners can be assured of reliable quality measurements for the printed GS1 endorsed symbol.

As a general rule, any ISO-based verifier (NIST or non-NIST traceable) should be periodically tested using a Calibrated Conformance Standard Test Card. This procedure will confirm both the accuracy of the instrument and the skill of the user.

5.5.3.3.10 Special considerations for verification of GS1 system symbologies

5.5.3.3.10.1 General

Since ISO verification does not measure dimensions, it is part of the additional visual checking that has to be carried out to ensure that, for example, the symbol height meets the application requirements.

With better digital imaging software, element dimensions can only be adjusted automatically to the nearest integer number of pixels in the output device, be it imagesetter or printer, enabling element width ratios to be maintained with allowance duly made, for example, for bar gain/loss and adjustment of element widths for digits 1, 2, 7, and 8 in EAN/UPC symbols. This means that symbol sizes may not match those input as target dimensions, but will vary in discrete steps within the permitted range, which will result in a more accurate symbol overall.



Note: For a list of international standards pertaining to GS1 system symbologies, see section [5.1.1](#)

5.5.3.3.10.2 Acceptance criteria

The acceptance criteria are intended to confirm that symbols adhere to all the requirements in the symbol specification tables with an allowance for a small measurement variation between commercial verifiers or operators:

- X-dimension is to have an Acceptance Criteria of 2% (-2% on the minimum specified X-dimension and +2% on the maximum specified X-dimension).
- The measurements for height and each Quiet Zone have an Acceptance Criteria of 5% (-5% on the minimum specified dimension and +5% on the maximum specified dimension).

5.5.3.3.10.3 EAN/UPC symbology

The main characteristic of the EAN/UPC symbology that affects verification is the different treatment of the three sets of symbol characters for digits 1, 2, 7, and 8 from the remaining digits (0, 3, 4, 5, 6, and 9). The reference decode algorithm uses the combined width of both bars in these characters to discriminate between a 1 and a 7, and between a 2 and an 8, which are ambiguously decodable since they share the same set of edge-to-similar-edge modular dimensions. The addition to or subtraction from the element widths of 1/13 module is intended to increase the differences between the sums of the bar widths for each pair of ambiguous characters. The decodability parameter for

these characters takes account of bar gain and loss whereas it does not for the remaining symbol characters. Consequently, a symbol not containing any of these four symbol characters may suffer substantial bar gain or loss without degrading its decodability, whereas a symbol that does contain one or more of them is likely to have a lower decodability grade, with the same amount of bar gain or loss. However, the laws of probability suggest that only some 6.9 percent of symbols would not be affected by this, so it is wise to be cautious and assume that bar gain or loss is a possible cause of a poor decodability grade for EAN/UPC symbols. It is also wise (for process control purposes) not to assume that the decodability grade correlates with bar width deviation, but it is far safer and easier to rely on the traditional measurement of bar width deviation for adjusting the production process.

The measuring aperture for EAN/UPC symbols is either 6 or 10 mils, depending on the application, as specified by the symbol specification tables.

Additional EAN/UPC symbol grading criteria

ISO/IEC 15416 Bar code print quality test specification - Linear symbols allows for additional pass/fail criteria to be stipulated by a symbology specification. For the EAN/UPC symbology, the minimum Quiet Zone dimensions are given in 5.2.1.4.4. Any individual scan profile which does not meet these requirements allowing for the following tolerances SHALL receive a grade of "0".

Figure 5.5.3.3.10.3-1. Minimum width of measured Quiet Zones

Symbol version	Left Quiet Zone	Right Quiet Zone
EAN-13	10X	6.2X
EAN-8	6.2X	6.2X
UPC-A	8X	8X
UPC-E	8X	6.2X
Add-ons (EAN)	EAN 13/8 right QZ	4.2X
Add-ons (U.P.C.)	UPC A/E right QZ	4.2X

Symbols that fall below range defined in 5.2.4.7 magnification factors SHALL receive a grade of 0 (see 5.5.3.4.3 for exception).

 **Note:** The choice of minimum Quiet Zone dimension was based on the historical U.P.C. Quality Guideline. Since EAN-13 and EAN-8 were not included, minimum Quiet Zone dimension similarly derived were chosen for those symbols.

5.5.3.3.10.4 GS1-128 symbology

The important aspects to verify for a GS1-128 symbol are its print quality, which is assessed in the standard way, and its formatting, which may need to be visually checked from the information output by the verifier. The Code 128 symbology is an edge-to-similar- edge decodable symbology, but its reference decode algorithm also requires a check of the sum of the widths of the three bars in each character as part of its parity checking process. Consequently, its decodability is affected by bar gain or loss.

Measuring apertures for GS1-128 symbols are 6 or 10 mils depending on the application and are specified in the symbol specification tables.

Data contained in GS1-128 symbols must be formatted according to these specifications for the use of GS1 Application Identifiers (AIs). Specific features to check are:

- Presence of Function 1 Symbol Character (FNC1) as a flag for the GS1 system subset of the Code 128 symbol, in the first position after the start character.
- Use of FNC1 or the control character <GS> (ASCII value 29 (decimal), 1D (hexadecimal)) as a separator character following non-predefined length element strings.
- Sequencing of AIs, with predefined length AIs preceding non-predefined length ones.
- Length of data fields with fixed length AIs.
- Correct formatting of data in all AI fields.

- Absence of encoded parentheses around AIs.
- The extent to which a verifier can do this automatically will vary greatly among devices, even those that have GS1-128 symbols as a specific symbology option.

5.5.3.3.10.5 ITF-14 symbology

ITF-14 barcodes are, unlike the others used in the GS1 system, two-width (narrow/wide) symbols that cannot be decoded by the edge-to-similar-edge technique, but all element widths must be measured. They are, therefore, more subject to the problems caused by bar gain or loss.

The standard ISO verification technique is fully applicable to these symbols. However, in the GS1 system application, additional checks must be made to ensure that the X-dimension (magnification factor) is within the permitted range.

Measuring apertures for the ITF-14 symbol SHALL be 10 mils for symbols with an X-dimension less than 0.635 millimetre (0.0250 in) and SHALL be 20 mils for symbols with an X-dimension equal to or greater than 0.635 millimetre (0.0250 in).

The minimum acceptable grade for symbols printed with the higher range of X-dimension (above 0.635 millimetre or 0.0250 in) SHALL be 0.5/20/660. This is because the brown corrugated substrates on which such symbols are often printed typically have a reflectance value below 40 percent, and sometimes below 30 percent, and cannot, therefore, ever achieve a symbol contrast better than 40 percent (the lower threshold for a grade 2 symbol contrast) no matter how dense the ink or how well the other attributes of the symbol are graded. As a result, the Scan Reflectance Profile (SRP) grade will most often be dictated by symbol contrast, so it cannot be higher than 1 for symbols on these materials, giving a maximum achievable overall symbol grade of 1.0.

Such symbols may also be affected by the inherent interference in the background reflectance caused by the substrate's composition, which may well lead to reduced defect grades and possibly low edge contrast and modulation values. It is, therefore, desirable to ensure that symbols printed on these corrugated materials are of as high a quality as possible in respect of the other parameters.

5.5.3.3.10.6 GS1 DataMatrix

Determining symbol quality for items marked with GS1 DataMatrix (both traditionally printed and direct part marked - DPM) involves a specialised approach due to the physical nature of the marking and the optical systems used to read those marks. The minimum symbol quality grade for GS1 DataMatrix symbols SHALL be specified by the application specification. The measurement of the quality parameters for DPM symbols SHALL be made by a verifier conforming to *ISO/IEC 15415* and when direct marked augmented with *ISO/IEC TR 29158* which defines DPM quality specific alternative illumination conditions, terms, parameters, modifications to the measurement and grading of certain parameters and the reporting of the grading results. According to these standards an overall grade is shown in the form:

Grade/Aperture/Light/Angle

Where:

- **"Grade"** is the overall symbol grade as defined in *ISO/IEC 15415 Information technology - Automatic identification and data capture techniques - Bar code print quality test specification - Two-dimensional symbols* (e.g., the arithmetic mean to one decimal place of the Scan Reflectance Profile or scan grades) with the additional information found in *ISO/IEC 29158 Information technology; Automatic identification and data capture techniques; direct part mark (DPM) Quality Guideline*. For GS1 DataMatrix, the grade number may be followed by an asterisk, *, which indicates that the surroundings of the symbol contain extremes of reflectance that may interfere with reading. For most applications, this should be specified as causing the symbol to fail.
- **"Aperture"** is the diameter in thousandths of an inch (to the nearest thousandth) of the synthetic aperture defined in *ISO/IEC 15415 Information technology - Automatic identification and data capture techniques - Bar code symbol print quality test specification - Two-dimensional symbols*.

- **"Light"** defines the illumination: A numeric value indicates the peak light wavelength in nanometres (for narrow band illumination); the alphabetic character W indicates that the symbol has been measured with broadband illumination ("white light"), the spectral response characteristics of which must imperatively be defined or have their source specification clearly referenced.
 - **"Angle"** is an additional parameter defining the angle of incidence (relative to the plane of the symbol) of the illumination. It SHALL be included in the reporting of the overall symbol grade when the angle of incidence is other than 45 degrees. Its absence indicates that the angle of incidence is 45 degrees.
- ✓ **Note:** This international standard provides for 30 degrees and 90 degrees illumination in addition to the default 45 degrees.

The aperture is normally specified as being 80 percent of the minimum X-dimension allowed for the application. The printing method must produce the GS1 DataMatrix "L" pattern with gaps between the dots less than 25 percent of the specified aperture. If symbols with greater than the minimum X dimension are allowed by the application, the same absolute maximum gap dimension must be maintained.

5.5.3.3.10.7 GS1 QR Code

Determining symbol quality for items marked with GS1 QR Code symbols involves a specialised approach due to the physical nature of the marking and the optical systems used to read those marks. The minimum symbol quality grade for GS1 QR Code symbols SHALL be specified by the application specification. The overall grade is shown in the form minimum grade/aperture/measuring wavelength.

Grade/Aperture/Light/Angle

Where:

- **"Grade"** is the overall symbol grade as defined in *ISO/IEC 15415 Information technology - Automatic identification and data capture techniques - Bar code print quality test specification - Two-dimensional symbols* (e.g., the arithmetic mean to one decimal place of the Scan Reflectance Profile or scan grades). For GS1 QR Code, the grade number may be followed by an asterisk, *, which indicates that the surroundings of the symbol contain extremes of reflectance that may interfere with reading. For most applications, this should be specified as causing the symbol to fail.
- **"Aperture"** is the diameter in thousandths of an inch (to the nearest thousandth) of the synthetic aperture defined in *ISO/IEC 15415 Information technology - Automatic identification and data capture techniques - Bar code symbol print quality test specification - Two-dimensional symbols*.
- **"Light"** defines the illumination: A numeric value indicates the peak light wavelength in nanometres (for narrow band illumination); the alphabetic character W indicates that the symbol has been measured with broadband illumination ("white light"), the spectral response characteristics of which must imperatively be defined or have their source specification clearly referenced.
- **"Angle"** is an additional parameter defining the angle of incidence (relative to the plane of the symbol) of the illumination. It SHALL be included in the reporting of the overall symbol grade when the angle of incidence is other than 45 degrees. Its absence indicates that the angle of incidence is 45 degrees.

The aperture is normally specified as being 80 percent of the minimum X-dimension allowed for the application

5.5.3.3.11 Possible causes of less-than-perfect verification grades

5.5.3.3.11.1 Reflectance parameters

Symbol contrast is governed by the reflectance of the substrate and ink. A symbol printed in black ink on a white paper will almost certainly achieve the top grade 4 for symbol contrast, as white papers typically have reflectance in excess of 75 percent, and black ink will usually have about 3 to 8 percent reflectance. Coloured backgrounds or coloured inks will affect the result. Highly glossy materials may also appear to have a lower background reflectance than expected. The worst case may be when printing on a corrugated brown fibreboard material, which may have a reflectance in a range between 27 and 40 percent, so even with a very dense, low reflectance ink it can never achieve better than the minimum passing grade 1 for symbol contrast (grade 1 includes symbol contrast values from 20 to 39 percent).

The causes of low symbol contrast and the solutions are:

- Background too dark: Use lighter or less glossy material, or change background colour (if printed) to one with higher reflectance.
- Bars too light: Change bar colour for one with lower reflectance, and increase ink weight or print head temperature (thermal printing) (Watch for consequential increase in bar widths).
- Show-through of contents: Use more opaque material for package, or print opaque white underlay prior to printing symbol.
- Show-through of imprint: Use more opaque labels.

Minimum reflectance, or R_{min} , must always be equal to or less than half the highest reflectance value, R_{max} . In practice, this means that the reflectance of at least one bar must meet this criterion. For example, if R_{max} is 70 percent, at least one bar must have a reflectance of 35 percent or less. A symbol that fails on this parameter will almost certainly have a low symbol contrast grade also. The cause of and solution for R_{min} being too high include:

- Bars too light: Change bar colour to one with lower reflectance, and increase ink weight or print head temperature (thermal printing) (Watch for consequential increase in bar widths).

Minimum Edge Contrast (EC_{min}) will always be lower than symbol contrast, but will only be a problem in itself if it approaches or drops below 15 percent (the pass/fail threshold). However, low edge contrast (EC) values, acceptable under this criterion, may still cause low modulation (MOD) grades. The causes of a low value of EC_{min} and the possible remedies are:

- Local variations in background reflectance (e.g., fragments of darker material in a recycled material): Use a more consistent substrate or one with higher reflectance.
- Local variations in inking of the bars: Adjust press settings to ensure even inking.
- Show-through of contents: Use more opaque material for package, or print opaque white underlay prior to printing symbol.
- Elements adjoining the edge in question are excessively narrow relative to the measuring aperture used: Increase X-dimension; ensure correct measuring aperture is used; ensure correct bar width adjustment (BWA) applied to film master/original symbol; print bars marginally narrower than spaces of same modular dimension.

Modulation, being calculated as the percentage of symbol contrast represented by the EC_{min} , will be reduced for the same reasons as when EC_{min} is low in the symbol. A scanner will tend to see spaces as narrower than bars and also to see narrow elements as less distinct than wider ones. Consequently, if there is significant bar loss, modulation will be reduced. Measuring with an aperture that is too large for the X-dimension will also reduce modulation.

The causes of a low value of modulation (often listed as "MOD" on verification reports) and the possible remedies are:

- Local variations in background reflectance (e.g., fragments of darker material in a recycled material): Use a more consistent substrate or one with higher reflectance.
- Local variations in inking of the bars: Adjust press settings to ensure even or darker inking.

- Show-through of contents: Use more opaque material for package, or print opaque white underlay prior to printing symbol.
- Element(s) adjoining the edge in question appear excessively narrow relative to the measuring aperture used: Increase X-dimension; ensure correct measuring aperture is used; apply correct BWA when originating symbol; print bars marginally narrower than spaces of same modular dimension.

5.5.3.3.12 Other parameters

Decode is graded on a pass/fail basis by applying the reference decode algorithm to the edge positions and element widths determined for the symbol. A failure to decode may be evidence of the symbol being incorrectly encoded, which may include an incorrect check digit. It also may indicate either that the bars and spaces initially identified by the global threshold are too many or too few for a valid symbol or that one or more edge positions are ambiguous. The possible causes of decode failure and possible remedies are:

- Symbol incorrectly encoded: Re-originate symbol; over-label with correctly encoded symbol.
- Check digit incorrectly calculated: Correct software error in origination system; re-originate symbol; over-label with correctly calculated symbol.
- Gross element width errors due to excessive bar gain or loss, or to defects: Apply correct bar width adjustment (BWA) when originating symbol; adjust press or printer settings.
- Too many elements detected due to defects: Correct cause of defects; adjust press (relief printing processes) to reduce haloing; replace print head (thermal/ink-jet printing).
- Too few elements detected (failure to cross global threshold): Refer to solutions for edge contrast (EC).

In the ISO standard, a decode failure occurs because an incorrect number of elements has been perceived to be present, either because the profile of one or more elements has failed to cross the global threshold or because a gross defect has caused one element to be seen as three or more, corresponding to the separately graded Edge Determination failure in the ANSI standard, which may also be reported by some verifiers following the ANSI methodology.

Figure 5.4.3.3.12-1 shows a symbol in which the narrow spaces have been partly filled in, reducing their contrast below the global threshold and causing an edge determination or decode failure. This could also be interpreted as an extreme example of modulation (MOD).

Figure 5.5.3.3.12-1. Symbol with edge determination problem

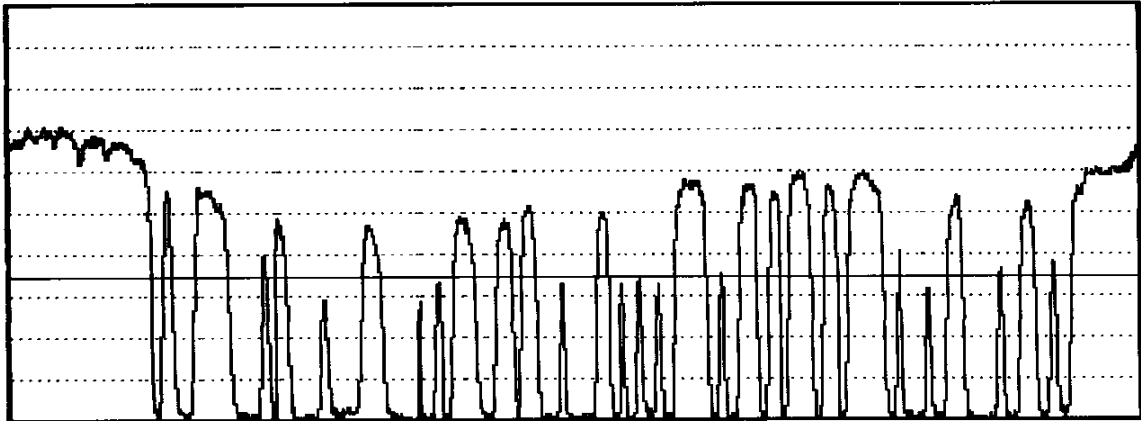

Figure 5.5.3.3.12-2 illustrates a Scan Reflectance Profile (SRP) showing narrow space profiles failing to reach the global threshold, giving an (ISO) decode failure or (ANSI) edge determination failure.

Figure 5.5.3.3.12-2. Scan Reflectance Profile with narrow space profiles

Decodability grades are influenced by bar gain or loss in most symbologies and by distortion of the symbol. Distortion can occur with relief printing processes, such as flexography, when the printing plate is stretched around the press cylinder with the bars parallel to the cylinder axis (e.g., at right angles to the print direction). A common reason for distortion with digitally-originated images is that they have been rescaled in graphics software, resulting in uneven addition or removal of pixels to or from the element widths. Print processes that tend to produce irregular bar edges, such as ink-jet and photogravure, will also be likely to give lower decodability grades. The causes of a low value of decodability and the possible remedies are:

- Bar gain/loss (systematic): Apply correct bar width adjustment (BWA) when originating symbol; adjust press settings.
- Element width gain/loss (non-systematic): Correct missing pixels (burnt-out print head elements, blocked ink-jet nozzles); rectify cause of defects.
- Distortion of symbol (uneven stretching of flexographic plate; non-linear disproportioning in plate-making process): Print symbol with height of bars parallel to direction of printing; do not disproportion barcode image in plate-making.
- Rescaling of digitally-originated images: Ensure symbol is created in correct size; ensure software matches module widths to integer number of pixels after all adjustments.
- Irregular element edges (ink-jet, photogravure, screen process printing): Change print technology; increase X-dimension/magnification factor; re-orient symbol relative to cylinder engraving angle/screen mesh.

The symbol in figure 5.5.3.3.12-3 is taken from the *GS1 Calibrated Conformance Standard Test Card* and has an engineered low decodability grade of 50 percent. As may be determined from the accompanying Scan Reflectance Profile (SRP), just to the left of halfway across the symbol, the width of a two-module bar has been increased in the sixth digit (and since the character is a 1, its decodability is affected by bar width). Although the original symbol has a very consistent image density, the profile also shows the effect of modulation (MOD), most noticeably on the narrow spaces.

Figure 5.5.3.3.12-3. Calibration symbol with engineered low decodability grade

Figure 5.5.3.3.12-4. Scan Reflectance Profile of symbol with low decodability character

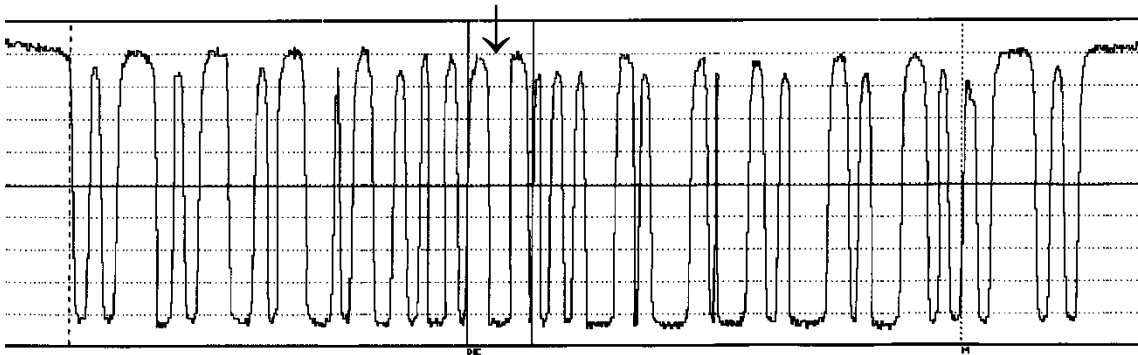

Defects, which show as irregularities in the Scan Reflectance Profile, may be caused by spots of extraneous ink in Quiet Zones or in the spaces. Small voids (white areas) in the bars are also highlighted as defects. In symbols printed on recycled or some other materials, local variations in reflectance of the background will also show as defects. The significance of a defect is in direct relation to the depth of the irregularity it causes in the Scan Reflectance Profile. Common causes and the most likely solutions include:

- Defective print head elements (thermal printing or ink-jet printing), which will tend to produce an unprinted line running through the symbol in the direction of printing: Clean or replace print head.
- Satellite (ink droplets in the white area surrounding the printed bars): Clean head; change ink formulation.
- Haloing (e.g., a double line impression where there should only be a single line impression): Adjust impression pressure and/or ink viscosity.
- Incorrect matching of thermal transfer ribbons and substrate (poor adhesion of ink to surface): Use correct ribbon for substrate; use smoother substrate.
- Measuring aperture too small: Use verifier with correct aperture.

The use of a smaller or larger measuring aperture than specified for the symbol will produce misleading defect grades, and this is perhaps the strongest argument for ensuring that the right aperture size is used. Too small an aperture will exaggerate the apparent size of a defect; too large an aperture will tend to smooth it out.

Quiet Zones are a frequent source of scanning problems. Although the ISO standard does not directly require measurement of the Quiet Zones, it requires any additional requirements specified by the application specification to be graded on a pass/fail basis. These *GS1 General Specifications* establish Quiet Zone requirements for all symbols used in the GS1 system, and a Quiet Zone less than the minimum width will, therefore, cause the profile grade to fail. Possible causes of Quiet Zone failure and the remedies are:

- Printed box surrounding symbol or other interfering print: Enlarge box; ensure symbol registration to other print allows adequate margins; use Quiet Zone Indicators if possible.
- Symbol too close to label edge: Adjust label feed; reposition symbol farther from edge; use larger label size or smaller symbol.

5.5.3.4 Print process characterisation techniques

5.5.3.4.1 Introduction

This section specifies when EAN/UPC symbols can be printed at less than the current minimum specification of 0.264 millimetres or 0.0104 inch X-dimension (80 percent magnification).

5.5.3.4.2 Background

Many printer users have asked if the magnifications in the 75 to 80 percent range for EAN/UPC symbols printed by thermal and laser on-demand printers are acceptable for use. The most common printing densities used by on-demand, barcode printers are 200 and 300 dpi. However, due to the constraints of the dot pitch, these printers cannot print an 80 percent symbol correctly. The nearest to 80 percent that these printers can print is 75.7 or 76.9 percent depending on the exact dot geometry.

Even though 80 percent magnification is the minimum value specified in the EAN/UPC symbol specification, users of on-demand printers have used magnifications between 75 and 80 percent in point-of-sale scanning environments for years. They have done so with no significant reduction in scan rate, as compared to symbols printed precisely at 80 percent. Because larger in-specification EAN/UPC symbols are always easier to scan, 80 percent symbols and larger are preferred. However, when an on-demand printer is required, the 75 to 80 percent EAN/UPC symbols are an acceptable alternative given the conditions in section [5.5.3.4.3](#).

5.5.3.4.3 New qualifications for printing

The allowance for EAN/UPC symbol magnifications from 75 to 80 percent is only applicable to "on demand" (e.g., thermal or laser) print processes. For all other printing processes, 80 percent is attainable and is the minimum allowable size.

When printing a minimum symbol with any method of printing, the area provided for printing the symbol and the required Quiet Zone SHOULD never be less than the area required for an 80 percent symbol. This area is derived from the total width of an 80 percent symbol times its height as shown in the dimensions in the figure below.

When printing a minimum symbol with any method of printing, the symbol height SHOULD never be truncated below the 80 percent value (20.7 millimetres or 0.816 inch).

The minimum print quality grade SHOULD be the same for all EAN/UPC symbols; at least an ISO/ANSI grade of 1.5 (or C). It is advisable to print EAN/UPC symbols that are at least a 2.5 (B) grade at the time of printing regardless of size.

Figure 5.5.3.4.3-1. EAN/UPC symbol shown with minimum height and overall width dimensions for magnifications of 75 percent to 80 percent

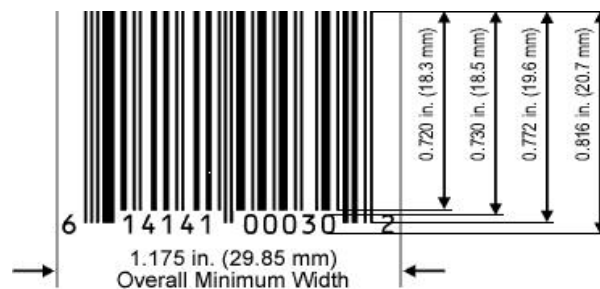

Note: As you move from 80 to 75 percent magnification, the Quiet Zone increases from 0.094 inch (2.38 millimetres) to 0.124 inch (3.16 millimetres) in order to keep the overall width constant at 1.175 inches (29.85 millimetres).

5.5.3.4.4 Summary

When printing with on-demand printers (e.g., thermal or laser) the resulting element widths for EAN/UPC symbols SHALL never be less than 75 percent magnification. If the symbol printed with element widths is less than 80 percent, then the overall symbol SHALL have both larger Quiet Zones and taller bars such that the resulting area is not less than that of 80 percent magnification symbols. The symbol print quality must still meet the EAN/UPC symbol requirements of 1.5/06/660.

5.5.3.5 GS1 barcode verification template

5.5.3.5.1 Introduction

These GS1 barcode verification templates were developed in co-operation with retailers, manufacturers, logistic providers and equipment providers to ensure a common reporting approach on a global level. They help ensure consistency regardless of where and by whom the symbols are tested thus removing the costly and inefficient requirements for multiple testing of identical symbols and reducing the cost of compliant equipment.

These templates do not introduce any requirements in and of themselves. The sole aim is to provide a common reporting format to measure compliance with the numbering and barcoding standards of GS1 laid down elsewhere in these *GS1 General Specifications*.

5.5.3.5.2 Background

GS1 has developed these verification templates on the basis of *ISO/IEC 15416 Information technology – Automatic identification and data capture techniques, Bar Code Print Quality Test Specifications for Linear Symbols* and *ISO/IEC 15415 Information technology – Automatic identification and data capture techniques – Bar code print quality test specification – Two dimensional symbols*. This not only allows for assessing the quality of printed barcodes but also checks against other key aspects of GS1 system (symbol location, fit-for purposes, data integrity, etc.).



Note: The acceptance criteria are intended to ensure that symbols adhere to all the requirements in the SSTs with an allowance for a small measurement variation.

A GS1 initiated Verifier Conformance Testing Project was conducted because of concerns expressed that different verifiers or verification services were unable to perform consistently. The perception was that different verifiers gave substantially different results when measuring the same symbol. A precisely defined test programme was performed under the auspices of GS1 and concluded that:

- All verifiers tested (each one ISO compliant) demonstrated the capability of consistent performance.
- Operators of verifiers require proper training and instruments require regular calibration in accordance with manufacturer recommendations.
- Most verifiers tested were capable of conforming to GS1 requirements.

It is therefore important to stress the need for professional verification services and that barcode print quality should be integral part of an overall quality programme. Section [5.5.2.7](#) provides a quick reference list of symbol quality specifications depending on the symbol type, the application, or the identification number the symbol is carrying.

All GS1 user companies should perform quality control of barcode production and most GS1 Member Organisations offer a verification service. These report templates may be used by any organisation or company as part of a quality programme while respecting the Copyright of the GS1 logo (or any heading or text that imply actual GS1 endorsement (subject to local licensing agreements such as accreditation programmes, which may allow exceptions)).

The templates below highlighting critical issues relating to verification and provides a common template for reporting on the most common areas of application. They are not a guarantee of scan performance.



5.5.3.5.3 GS1 barcode verification template for linear symbols

<NAME> Issue date <Date of Issue>
 <Line one address>
 <Line two address>
 <Town>
 <Postcode>
Product Description: <Brand and name of product>
Type of barcode: <Symbol type>
Data encoded: < Data encoded>
Number of barcodes on product: <Number of symbols>

Please Note: These assessments are based on meeting the minimum GS1 standards.
 To ensure efficient scanning, the barcode should exceed the minimum.

Testing summary of the linear symbol

GS1 General Specifications for linear symbols tested environments:	
PASS or FAIL or Not assessed for retail point-of-sale scanning	
PASS or FAIL or Not assessed for general distribution and logistics scanning	
PASS or FAIL or Not assessed for other scanning applications (specify) _____	

Complies with GS1 symbol location recommendations	In/out spec (& comment on business critical issue)
ISO/IEC print quality grade	ISO/IEC <x.x>/06/660 (0.0 – 4.0) PASS/FAIL

Business critical comments

Technical analysis of the linear symbol

GS1 parameters	Comment reference	Assessed	Within standard range	Required	ISO/IEC parameters	Comment Reference	Grade ISO/IEC	Within standard range	Required
Symbol structure ¹			✓	(dependent on symbol encoded)	Overall ISO/IEC grade ²		3.8/06/660	✓	≥ 1.5
X-dimension (magnification)		0.330mm ³ (0.0130 inch)	✓	0.264 -0.660 mm (0.0104 - 0.0260 inch)	Decode		4.0	✓	
Barcode height		23mm (0.9 inch)	✓	22.85mm (0.900 inch)	Symbol contrast		3.8	✓	
Quiet Zone (left)			✓	3.63mm (0.143 inch)	Minimum reflectance		4.0	✓	
Quiet Zone (right)			✓	2.31mm (0.091 inch)	Edge contrast		4.0	✓	
Human readable			✓	One-to-one match with barcode data	Modulation		4.0	✓	
Barcode width			✓	≤165.10 mm (≤6.500 inch)	Defects		4.0	✓	
Validity of GS1 Company Prefix			✓		Decodability		4.0	✓	
Data structure			✓	(dependent on structure encoded)					

Educational comments⁴

(1) Includes check digits, ITF-14 wide-to-narrow ratio, etc.
 (3) The text in red in this table provides sample results from the testing of an EAN/UPC symbol.

(2) 0.5 acceptable for ITF-14 with X-dimension ≥ 0.635mm
 (4) Educational comments are based on the technical analysis of the symbol. In this comment box the operator comments on what the problem is and how to make the symbol better

Notes (informative localised)

It is the responsibility of the GS1 Company Prefix licensee or GS1 identification key licensee to ensure the correct use of the GS1 Company Prefix and the correct allocation of the data content. Rejection of products should not necessarily be based only on an out of specification results
 Barcode verifiers are measuring devices and are tools that can be used for assisting in quality control. The results are not absolute in that they do not necessarily prove or disprove that the barcode will scan. This report may not be amended after issue. In the event of a dispute over contents the version held at [TESTING AGENCY] will be deemed to be the correct and original version of this report.

Notes (informative localised)

This Verification Report may contain privileged and confidential information intended only for the use of the addressee named above. If you are not the intended recipient of this report you are hereby notified that any use, dissemination, distribution or reproduction of this message is prohibited. If you received this message in error please notify [TESTING AGENCY].

Disclaimer (legal localised)

This report does not constitute evidence for the purpose of any litigation, and [TESTING AGENCY] will not enter into any discussion, or respond to any correspondence in relation to litigation.
 Every possible effort has been made to ensure that the information and specifications in the Barcode Verification Reports are correct, however, [TESTING AGENCY] expressly disclaims liability for any errors.

5.5.3.5.4 GS1 barcode verification template for two dimensional symbols

<NAME> Issue date <Date of Issue>
 <Line one address>
 <Line two address>
 <Town>
 <Postcode>
Product Description: <Brand and Name of Product>
Type of barcode: <Symbol Type>
Data encoded: < Data encoded>
Print Method: <Print Method>
Number of barcodes on product: <Number of Symbols>

Please Note: These assessments are based on meeting the minimum GS1 standards.
 To ensure efficient scanning, the barcode should exceed the minimum.

Testing summary of the two dimensional symbol

GS1 General Specifications for two dimensional symbols, environments tested:	
PASS or FAIL or Not assessed	Healthcare items (healthcare retail consumer item or healthcare non-retail consumer item or healthcare trade item)
PASS or FAIL or Not assessed	Direct part marking (DPM)
PASS or FAIL or Not assessed	Extended packaging
Complies to GS1 symbol location recommendations	In/out spec (& comment on business critical issue)
ISO symbol grade	ISO <x.x>/06/660 (0.0 – 4.0) PASS/FAIL
Business critical comments	

Technical analysis of the two dimensional symbol

GS1 parameters	Comment reference	Values	Within standard range	Required
Symbol structure			✓	Dependent on symbol encoded
Matrix size		NN X NN	✓	
X-dimension/cell size		mm (inch)	✓	
Data structure			✓	Dependent on structure encoded
Validity of GS1 Company Prefix			✓	
Human readable			✓	

ISO/IEC parameters	Comment reference	ISO grade 4 to 0	Within standard range	Required
Overall ISO grade			✓	
Decode		PASS / FAIL	✓	
Cell contrast/Symbol contrast		4 - 0	✓	
Cell modulation/Modulation		4 - 0	✓	
Axial nonuniformity		4 - 0	✓	
Grid Nonuniformity		4 - 0	✓	
Unused Error Correction (UEC)		4 - 0	✓	
Print growth (horizontal) informative only		0%-100%	Non-graded	
Print growth (vertical) informative only		0%-100%	Non-graded	
Fixed pattern damage		4 - 0	✓	
Clock track and solid area regularity*		4 - 0	✓	
Quiet Zones (QZL1, QZL2)*		4 - 0	✓	
L1 and L2*		4 - 0	✓	
Format information**				
Version information**				

Educational comments ⁵

Notes (informative localised)

It is the responsibility of the GS1 Company Prefix licensee or GS1 identification key licensee to ensure the correct use of the GS1 Company Prefix and the correct allocation of the data content. Rejection of products should not necessarily be based only on an out of specification results

Barcode verifiers are measuring devices and are tools that can be used for assisting in quality control. The results are not absolute in that they do not necessarily prove or disprove that the barcode will scan.

This report may not be amended after issue. In the event of a dispute over contents the version held at [TESTING AGENCY] will be deemed to be the correct and original version of this report.

* GS1 DataMatrix Only, see ISO/IEC 15415
 ** GS1 QR Code Only, see ISO/IEC 15415,
 all others are both for GS1 DataMatrix and GS1 QR Code

Important Note (normative localised)

This Verification Report may contain privileged and confidential information intended only for the use of the addressee named above. If you are not the intended recipient of this report you are hereby notified that any use, dissemination, distribution or reproduction of this message is prohibited. If you received this message in error please notify [TESTING AGENCY].

Disclaimer (legal localised)

This report does not constitute evidence for the purpose of any litigation, and [TESTING AGENCY] will not enter into any discussion, or respond to any correspondence in relation to litigation.

Every possible effort has been made to ensure that the information and specifications in the Barcode Verification Reports are correct, however, [TESTING AGENCY] expressly disclaims liability for any errors.

⁵ Educational comments are based on the technical analysis of the symbol. In this comment box the operator comments on what the problem is and how to make the symbol better by explaining the parameter's meanings.

5.6 Linear barcodes – GS1 DataBar

5.6.1 Introduction

GS1 DataBar is a family of linear symbologies used within the GS1 system. There are three types of GS1 DataBar symbols, two of which have a number of variations optimised for different application requirements.

The first type has four variations (GS1 DataBar Omnidirectional, GS1 DataBar Truncated, GS1 DataBar Stacked and GS1 DataBar Stacked Omnidirectional) and encodes AI (01) in a linear symbol. The second type comprises only one variation namely GS1 DataBar Limited which encodes AI (01) in a linear symbol for use on small items that will not be scanned in an omnidirectional scanning environment. The third type has two variations; a single row variation (GS1 DataBar Expanded) and a multi-row stacked variation (GS1 DataBar Expanded Stacked). Both variations encode GS1 system primary item identification plus supplementary AI element strings, such as weight and “best before” date, in a linear symbol that can be scanned omnidirectionally by suitably programmed slot scanners.

GS1 DataBar Stacked is a variation of the first type of GS1 DataBar symbology that is stacked in two rows and used when the normal symbol would be too wide for the application. It comes in two variations: a truncated variation used for small item marking applications and a taller variation that is designed to be read by omnidirectional scanners. GS1 DataBar Expanded can also be printed in multiple rows as a stacked symbol.

Any member of the GS1 DataBar family can be printed as a stand-alone linear symbol or as a component of a composite symbol with an accompanying two-dimensional (2D) Composite Component printed above the GS1 DataBar linear component.

The GS1 DataBar family is fully described in *ISO/IEC 24724*.

5.6.1.1 Symbology characteristics

The GS1 DataBar family consists of the following variations:

- GS1 DataBar Omnidirectional.
- GS1 DataBar Truncated.
- GS1 DataBar Stacked.
- GS1 DataBar Stacked Omnidirectional.
- GS1 DataBar Limited.
- GS1 DataBar Expanded.
- GS1 DataBar Expanded Stacked.

The characteristics of the GS1 DataBar family are:

- Encodable character set:
 - GS1 DataBar Omnidirectional, GS1 DataBar Truncated, GS1 DataBar Stacked, GS1 DataBar Stacked Omnidirectional and GS1 DataBar Limited: Digits 0 through 9 (with the restriction of GS1 DataBar Limited to 0 or 1 in the first digit) in accordance with *ISO/IEC 646*. Refer to [Figure 7.11-1](#) for more details.
 - GS1 DataBar Expanded variations: The GS1 system requires that only the subset of *ISO/IEC 646 International Reference Version* defined in these *GS1 General Specifications* be used for GS1 Application Identifier (AI) element strings. Refer to [Figure 7.11-1](#) for the allowed encodable character set.
- Symbol character structure: Different (n,k) symbol characters are used for each member of the family, where each symbol character is n modules in width and is composed of k bars and k spaces.
- Code type: Continuous, linear barcode symbology.

- Maximum numeric data capacity (including implied GS1 Application Identifiers (AIs) where appropriate, but not including any encoded FNC1 characters):
 - All GS1 DataBar symbols except the expanded versions: AI (01) plus a 14-digit numeric item identification.
 - GS1 DataBar Expanded variations: 74 numeric or 41 alphabetic characters.
- Error detection:
 - GS1 DataBar Omnidirectional, GS1 DataBar Truncated, GS1 DataBar Stacked and GS1 DataBar Stacked Omnidirectional: mod 79 checksum.
 - GS1 DataBar Limited: mod 89 checksum.
 - GS1 DataBar Expanded variations: mod 211 checksum.
- Character self-checking.
- Bidirectionally decodable.
- Quiet Zones: None required.

5.6.1.2 Additional features

Additional GS1 DataBar features include:

- Data compaction: Each member of the GS1 DataBar family has data compaction methods optimised for the data strings that it will encode. GS1 DataBar Expanded variations are also optimised for specific sequences of GS1 Application Identifiers (AIs) that are commonly used.
- Component linkage: All GS1 DataBar symbols include a linkage flag. If the linkage flag is 0, then the GS1 DataBar symbol stands alone. If the linkage flag is 1, then a 2D Composite Component and its separator pattern are printed above the GS1 DataBar symbol with the separator pattern aligned and contiguous to the GS1 DataBar symbol.
- Edge to similar edge decoding: All GS1 DataBar family symbol characters, finder patterns, and symbol check characters can be decoded using edge-to-edge measurements.
- Large symbol characters: Unlike EAN/UPC symbols, a GS1 DataBar symbol's symbol characters do not directly correspond to the encoded data character. The symbol's symbol characters encode thousands of possible combinations to increase the encoding efficiency. They are then combined mathematically to form the encoded data string.
- GS1-128 symbol emulation: Readers set to the GS1-128 symbol emulation mode transmit the data encoded within a GS1 DataBar symbol as if the data were encoded in one or more GS1-128 symbols.

5.6.2 Symbol structure

5.6.2.1 The first group of GS1 DataBar symbols

The first group of GS1 DataBar symbols encodes the element string AI (01). It has four variations: GS1 DataBar Omnidirectional, GS1 DataBar Truncated, GS1 DataBar Stacked, and GS1 DataBar Stacked Omnidirectional. All four variations encode data in an identical manner.

Figure 5.6.2.1-1 shows the structure of this group of GS1 DataBar symbols. These four different symbols, as explained below, contain four symbol characters and two finder patterns. The symbols are capable of being scanned in four separate segments, each consisting of a symbol character and an adjacent finder pattern. The two finder patterns together encode a modulo 79 check value for data security.

Figure 5.6.2.1-1. First group of GS1 DataBar symbols structure

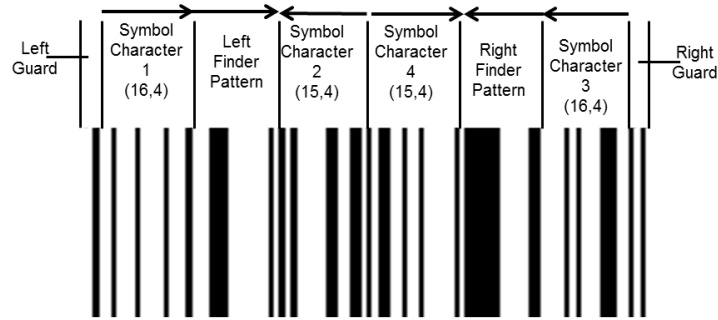

The left and right guard bar patterns consist of a narrow space and narrow bar. These variations do not require a Quiet Zone.

5.6.2.1.1 GS1 DataBar Omnidirectional

The GS1 DataBar Omnidirectional barcode is designed to be read by an omnidirectional scanner, such as a retail slot scanner. Its dimensions are 96X wide, starting with a 1X space and ending with a 1X bar, by 33X high (where X is the width of a module). 33X is the minimum height of the symbol but the actual height of the symbol used depends on the specific application requirements. For example, a GS1 DataBar Omnidirectional symbol with an X-dimension of 0.254 millimetre (0.0100 inch) would be 24.38 millimetre (0.960 inch) wide and 8.38 millimetre (0.330 inch) high.

Figure 5.6.2.1.1-1. GS1 DataBar Omnidirectional barcode



5.6.2.1.2 GS1 DataBar Truncated

The GS1 DataBar Truncated barcode is a reduced height variation of the GS1 DataBar Omnidirectional barcode that is designed for small items that will not need to be read by omnidirectional scanners. Its dimensions are 96X wide by 13X high (where X is the width of a module). For example, a GS1 DataBar Truncated symbol with an X-dimension of 0.254 millimetre (0.0100 inch) would be 24.38 millimetres (0.960 inch) wide by 3.30 millimetres (0.130 inch) high.

Figure 5.6.2.1.2-1. GS1 DataBar Truncated barcode



5.6.2.1.3 GS1 DataBar Stacked

The GS1 DataBar Stacked barcode is a reduced height two-row variation of the GS1 DataBar Omnidirectional barcode that is designed for small items that will not need to be read by omnidirectional scanners. Its dimensions are 50X wide by 13X high (where X is the width of a module). For example, a GS1 DataBar Stacked symbol with an X-dimension of 0.254 millimetre (0.0100 inch) would be 12.70 millimetres (0.500 inch) wide by 3.30 millimetres (0.130 inch) high. Its structure includes a 1X high separator pattern between the two rows.

Figure 5.6.2.1.3-1. GS1 DataBar Stacked barcode



5.6.2.1.4 GS1 DataBar Stacked Omnidirectional

The GS1 DataBar Stacked Omnidirectional barcode is a full height, two-row variation of the GS1 DataBar Omnidirectional barcode that is designed to be read by an omnidirectional scanner, such as a retail slot scanner. Its dimensions are 50X wide by 69X high (where X is the width of a module). 69X is the minimum height of the symbol but the actual height of the symbol used depends on the specific application requirements. For example, a GS1 DataBar Stacked Omnidirectional symbol with an X-dimension of 0.254 millimetre (0.0100 inch) would be 12.70 millimetres (0.500 inch) wide by 17.53 millimetres (0.690 inch) high. The height of 69X includes a 3X high separator pattern between two rows of 33X each.

Figure 5.6.2.1.4-1. GS1 DataBar Stacked Omnidirectional barcode



5.6.2.2 The second group of GS1 DataBar symbols: GS1 DataBar Limited

The GS1 DataBar Limited barcode is the second group of GS1 DataBar symbols. It encodes the element string AI (01). This element string is based on the GTIN-12, GTIN-13, or GTIN-14 data structures. However, when using the GTIN-14 data structure, only the indicator value 1 is allowed. When encoding GTIN-14 data structures with an indicator value greater than 1, one of the first group of GS1 DataBar symbols must be used: see section [5.6.2.1](#).

The GS1 DataBar Limited barcode is designed for small items that will not need to be read by omnidirectional point-of-sale (POS) scanners. Its dimensions are 79X wide, starting with a 1X space and ending with a 5X space, by 10X high (where X is the width of a module). For example, a GS1 DataBar Limited barcode with an X-dimension of 0.254 millimetre (0.0100 inch) would be 20.07 millimetres (0.790 inches) wide by 2.54 millimetres (0.100 inch) high.

Figure 5.6.2.2-1. GS1 DataBar Limited barcode

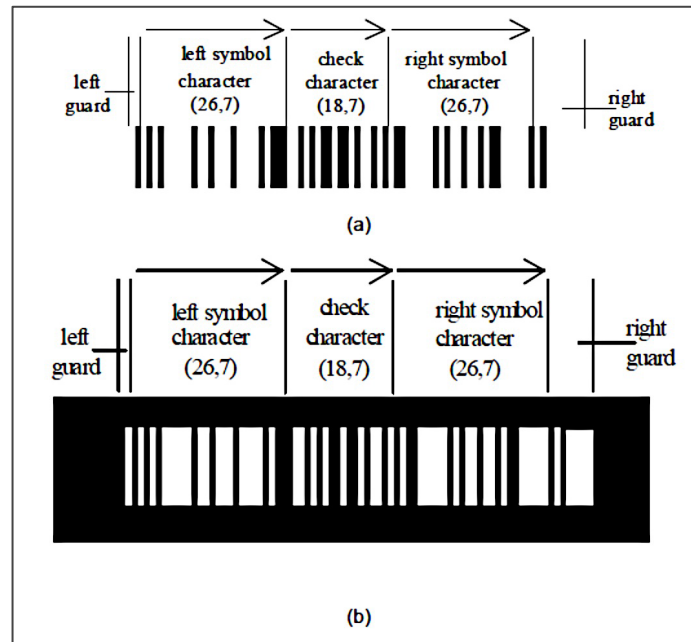

Figure 5.6.2.2-2 shows the structure of the GS1 DataBar Limited barcode. A GS1 DataBar Limited symbol contains two data characters and a symbol check character. The symbol check character encodes a modulo 89 check value for data security.

Figure 5.6.2.2-2. GS1 DataBar Limited barcode structure

(a) GS1 DataBar Limited symbol representing (01)00312345678906

(b) The same symbol on a dark background. Notice the trailing space in the right guard pattern

The total symbol contains 47 elements comprising 79 modules. The minimum height SHALL be 10X. No Quiet Zones are required, however while each light module on both ends of the Limited symbol may look like a Quiet Zone, each differs from a Quiet Zone in that the reference decode algorithm must check for these guard bar patterns in order to avoid misreading a UPC-A symbol as a GS1 DataBar Limited symbol. The leading and trailing space elements may blend into the background of the symbol if that background is the same colour as the spaces in the symbol.

5.6.2.3 The third group of GS1 DataBar symbols: GS1 DataBar Expanded variations

GS1 DataBar Expanded variations are the third group of GS1 DataBar symbols and are a variable length linear symbology capable of encoding up to 74 numeric or 41 alphabetic characters of AI element string data. The two variations, GS1 DataBar Expanded and GS1 DataBar Expanded Stacked are designed to encode primary and supplementary data on items for point-of-sale (POS) and other applications. They have the same capabilities as a GS1-128 symbol except that they are also designed to be scanned by omnidirectional slot scanners. They are designed for variable weight products, perishable products, traceable retail products, and coupons.

Figure 5.6.2.3-1 shows the structure of a six-segment GS1 DataBar Expanded symbol. GS1 DataBar Expanded symbols contain a symbol check character, 3 to 21 symbol characters and 2 to 11 finder patterns, depending on the symbol length. GS1 DataBar Expanded is capable of being scanned in separate segments, each segment consisting of a symbol character or symbol check character and the adjacent finder pattern. The symbol check character encodes a modulo 211 check value for data security.

Figure 5.6.2.3-1. GS1 DataBar Expanded structure

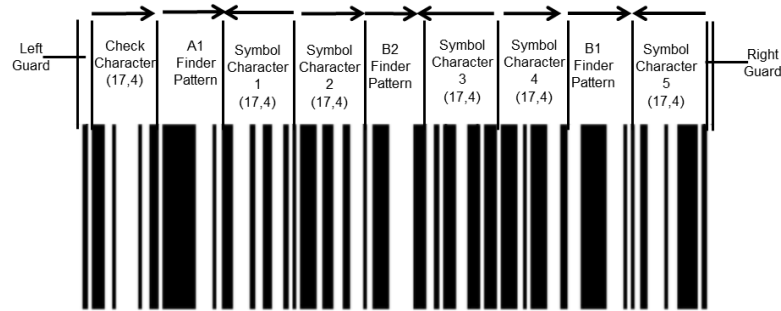

The left and right guard bar patterns consist of a narrow bar and narrow space. GS1 DataBar Expanded variations do not require a Quiet Zone.

5.6.2.3.1 GS1 DataBar Expanded

The GS1 DataBar Expanded barcode has a variable width (from 4 to 22 symbol characters, or a minimum of 102X wide and a maximum of 534X wide) and is 34X high (where X is the width of a module). The symbol starts with a 1X space and ends with either a 1X bar or space. For example, the GS1 DataBar Expanded Symbol shown in figure 5.6.2.3.1-1 with an X-dimension of 0.254 millimetre (0.0100 inch) would be 38.35 millimetres (1.51 inches) wide by 8.64 millimetres (0.340 inch) high.

Figure 5.6.2.3.1-1. GS1 DataBar Expanded barcode



(01)90614141000015(3202)000150

5.6.2.3.2 GS1 DataBar Expanded Stacked

The GS1 DataBar Expanded Stacked barcode is a multi-row stacked variation of GS1 DataBar Expanded. It can be printed in widths of 2 to 20 segments and can have from 2 to 11 rows. Its structure includes a 3X high separator pattern between rows. It is designed to be read by an omnidirectional scanner such as a retail slot scanner. The GS1 DataBar Expanded Stacked symbol shown in figure 5.6.2.3.2-1 with an X-dimension of 0.254 millimetre (0.0100 inch) would be 25.91 millimetres (1.020 inches) wide by 18.03 millimetres (0.710 inch) high.

The white space at the end of the second row of the symbol shown in the figure below is not part of the symbol and can be used for other purposes, such as text.

Figure 5.6.2.3.2-1. GS1 DataBar Expanded Stacked barcode



(01)90614141000015(3202)000150

GS1 DataBar Expanded Stacked is used when the symbol area or print mechanism is not wide enough to accommodate the full single-row GS1 DataBar Expanded symbol. It is designed for variable weight products, perishable products, traceable retail products, and coupons.

5.6.2.3.3 Compressed element string sequences

While GS1 DataBar Expanded symbols can encode any sequence of GS1 Application Identifier (AI) data up to the maximum capacity of the symbol, certain sequences of AI element strings have been selected for special compression in GS1 DataBar Expanded variations. If the application requires the use of the AI element strings in one of these sequences and they are used in the predefined sequence, a smaller symbol will result.

The selected sequences are two types: fixed length, where the sequence of selected AI element strings is the only data encoded, and open-ended, where the sequence occurs at the start of the symbol's data, and other AI element strings may be added following the sequence. If the data to be encoded in a GS1 DataBar Expanded symbol starts with a sequence defined as fixed length but is followed by additional AI element strings, all the data will be encoded normally without special compression.

5.6.2.3.3.1 Fixed-length sequences

This section contains information on fixed-length sequences.

AI (01) and weight with limited range

This sequence consists of the two GS1 Application Identifier (AI) element strings AI (01), followed by AI (3103), AI (3202), or AI (3203) for weight. The AI (01) element string must start with an indicator value of 9 for variable measure. Using AI (3103) (weight in grams), the special compression can only be applied up to a maximum weight of 32.767 kilograms. Using AI (3202) (weight in 0.01 pounds) the special compression can only be applied up to a maximum weight of 99.99 pounds. Using AI (3203) (weight in 0.001 pounds) the special compression can only be applied up to a maximum weight of 22.767 pounds. If the weight is in excess of these values, the sequence defined in section [5.6.2.3.3.1](#) still enables special compression to be performed.

AI (01): Weight and optional date

This sequence consists of the two or three GS1 Application Identifier (AI) element strings AI (01), AI (310n), or (320n) for weight (n ranging from 0 to 9) and optionally AI (11), AI (13), AI (15), or AI (17) for date. The AI (01) element string must start with an indicator value of 9 for variable measure. If the date is not needed, this sequence still gives additional compression when the weight is outside the ranges required by the AI (01) and weight with limited range sequence above.

5.6.2.3.3.2 Open-ended sequences

This section contains information on open-ended sequences.

AI (01) and price

This sequence consists of the two GS1 Application Identifier (AI) element strings, AI (01), followed by AI (392x) for price or AI (393x) for price with ISO currency code (where x is in the range of 0 to 3). The AI (01) element string must start with an indicator value of 9 for variable measure. For example, this sequence is used for an AI (01) element string, price and weight, because the fixed-length sequence AI (01) and weight does not give additional compression if the AI element string for price is added to the end since the length of the sequence is fixed.

AI (01)

Any sequence that starts with GS1 Application Identifier (AI) (01) will have special compression applied to the AI (01). So when the data includes AI (01), it SHALL be the first element string encoded.

5.6.2.3.4 Maximum width and height of GS1 DataBar Expanded versions (informative)

Advice for maximum symbol size to optimise scanner performance

5.6.2.3.4.1 Maximum symbol width (flat surface)

For GS1 DataBar Expanded and GS1 DataBar Expanded Stacked symbols scanned with an omnidirectional slot scanner, the following maximum symbol length is recommended: 158.75 mm (6.250 inch).

For GS1 DataBar Expanded and GS1 DataBar Expanded Stacked symbols scanned with a presentation scanner, the following maximum symbol length is recommended: 158.75 mm (6.250 inch).

For GS1 DataBar Expanded and GS1 DataBar Expanded Stacked symbols scanned with a hand held scanner, the following maximum symbol length is recommended as;

- Hand Held Linear (Laser) Scanner: 158.75 mm (6.250 inch).
- Hand Held Linear (CCD type) Scanner: 101.60 mm (4.000 inch).
- Hand Held Imager (2D) Scanner: 158.75 mm (6.250 inch).

GS1 DataBar Expanded - Symbol Length vs. Symbol Characters

Figure 5.6.2.3.4.1-1. GS1 DataBar symbol length specification (flat surface) Table 1

X [inch]	0.0080		0.010		0.0130		0.0260		0.0390	
X [mm]		0.203		0.254		0.330		0.660		0.991
Characters										
4	0.816	20.73	1.020	25.91	1.326	33.68	2.652	67.36	3.978	101.04
5	1.072	27.23	1.340	34.04	1.742	44.25	3.484	88.49	5.226	132.74
6	1.208	30.68	1.510	38.35	1.963	49.86	3.926	99.72	5.889	149.58
7	1.464	37.19	1.830	46.48	2.379	60.43	4.758	120.85	7.137	181.28
8	1.600	40.64	2.000	50.80	2.600	66.04	5.200	132.08	7.800	198.12
9	1.856	47.14	2.320	58.93	3.016	76.61	6.032	153.21	9.048	229.82
10	1.992	50.60	2.490	63.25	3.237	82.22	6.474	164.44	9.711	246.66
11	2.248	57.10	2.810	71.37	3.653	92.79	7.306	185.57	10.959	278.36
12	2.384	60.55	2.980	75.69	3.874	98.40	7.748	196.80	11.622	295.20
13	2.640	67.06	3.300	83.82	4.290	108.97	8.580	217.93	12.870	326.90
14	2.776	70.51	3.470	88.14	4.511	114.58	9.022	229.16	13.533	343.74
15	3.032	77.01	3.790	96.27	4.927	125.15	9.854	250.29	14.781	375.44
16	3.168	80.47	3.960	100.58	5.148	130.76	10.296	261.52	15.444	392.28
17	3.424	86.97	4.280	108.71	5.564	141.33	11.128	282.65	16.692	423.98
18	3.560	90.42	4.450	113.03	5.785	146.94	11.570	293.88	17.355	440.82
19	3.816	96.93	4.770	121.16	6.201	157.51	12.402	315.01	18.603	472.52
20	3.952	100.38	4.940	125.48	6.422	163.12	12.844	326.24	19.266	489.36
21	4.208	106.88	5.260	133.60	6.838	173.69	13.676	347.37	20.514	521.06
22	4.344	110.34	5.430	137.92	7.059	179.30	14.118	358.60	21.177	537.90

Best Performance
Not Recommended

5.6.2.3.4.2 Maximum symbol width (curved surface)

For GS1 DataBar Expanded Variation symbols with a maximum subtended angle of 60° (see figure 6.2.3.2-2 Relationship between symbol and curvature), Table 2 provides the length of a GS1 DataBar Expanded Variation symbol as a function of the X-dimension chosen. Tests show that GS1 DataBar Expanded Variations have decreased performance at the maximum angle and it is recommended that, when possible, these symbols be made such that a smaller angle is subtended.

Figure 5.6.2.3.4.2-1. GS1 DataBar symbol length specification (curved surface) Table 2

Diameter (inch)	0.25	0.50	0.75	1.00	1.25	1.50	1.75	2.00	2.50	3.00
Lmax (inch)	0.131	0.262	0.393	0.524	0.654	0.785	0.916	1.047	1.309	1.571
Diameter (mm)	6.35	12.70	19.05	25.40	31.75	38.10	44.45	50.80	63.50	76.20
Lmax (mm)	3.32	6.65	9.97	13.30	16.62	19.95	23.27	26.60	33.25	39.90
Diameter (inch)	3.50	4.00	4.50	5.00	5.50	6.00	6.50	7.00	7.50	8.00
Lmax (inch)	1.833	2.094	2.356	2.618	2.880	3.142	3.456	3.665	3.927	4.189
Diameter (mm)	88.90	101.60	114.30	127.00	139.70	152.40	167.64	177.80	190.50	203.20
Lmax (mm)	46.55	53.20	59.85	66.50	73.15	79.80	87.78	93.10	99.75	106.40
Diameter (inch)	8.50	9.00	9.50	10.00	20.00	30.00	40.00	50.00	60.00	
Lmax (inch)	4.451	4.712	4.974	5.236	10.472	15.708	20.944	26.180	31.42	
Diameter (mm)	215.90	228.60	241.30	254.00	508.00	762.00	1016.00	1270.00	1524.00	
Lmax (mm)	113.05	119.69	126.34	132.99	265.99	398.98	531.98	664.97	797.96	
Diameter (inch)	0.25	0.50	0.75	1.00	1.25	1.50	1.75	2.00	2.50	3.00
Lmax (inch)	0.131	0.262	0.393	0.524	0.654	0.785	0.916	1.047	1.309	1.571
Diameter (mm)	6.35	12.70	19.05	25.40	31.75	38.10	44.45	50.80	63.50	76.20
Lmax (mm)	3.32	6.65	9.97	13.30	16.62	19.95	23.27	26.60	33.25	39.90
Diameter (inch)	3.50	4.00	4.50	5.00	5.50	6.00	6.50	7.00	7.50	8.00
Lmax (inch)	1.833	2.094	2.356	2.618	2.880	3.142	3.456	3.665	3.927	4.189
Diameter (mm)	88.90	101.60	114.30	127.00	139.70	152.40	167.64	177.80	190.50	203.20
Lmax (mm)	46.55	53.20	59.85	66.50	73.15	79.80	87.78	93.10	99.75	106.40
Diameter (inch)	8.50	9.00	9.50	10.00	20.00	30.00	40.00	50.00	60.00	
Lmax (inch)	4.451	4.712	4.974	5.236	10.472	15.708	20.944	26.180	31.42	
Diameter (mm)	215.90	228.60	241.30	254.00	508.00	762.00	1016.00	1270.00	1524.00	
Lmax (mm)	113.05	119.69	126.34	132.99	265.99	398.98	531.98	664.97	797.96	



Note: See figure 6.2.3.2-3 Relationship between diameter and the X-dimension.

5.6.2.3.4.3 Maximum height GS1 DataBar Expanded Stacked

For GS1 DataBar Expanded Stacked symbols, Table 3 provides the height of the symbol as a function of the number of rows and X-dimension chosen. Advice is provided, as a result of tests conducted, that indicate (shading of table cells) scanning performance as a function of the number of rows and X-dimension. It should be noted that the testing showed, independent of X-dimension, significant reduction in scanner performance, for symbols containing more than 7 rows.

Figure 5.6.2.3.4.3-1. GS1 DataBar Expanded Stacked height specification (informative) Table 3

Height of GS1 DataBar Expanded Stacked by row [metric units]										
X [mm]		0.203	0.254	0.330	0.381	0.508	0.660	0.762	0.889	0.991
Row	Height (modules)									
2	71	14.41	18.03	23.43	27.05	36.07	46.86	54.10	63.12	70.36
3	108	21.92	27.43	35.64	41.15	54.86	71.28	82.30	96.01	107.03
4	145	29.44	36.83	47.85	55.25	73.66	95.70	110.49	128.91	143.70
5	182	36.95	46.23	60.06	69.34	92.46	120.12	138.68	161.80	180.36
6	219	44.46	55.63	72.27	83.44	111.25	144.54	166.88	194.69	217.03
7	256	51.97	65.02	84.48	97.54	130.05	168.96	195.07	227.58	253.70
8	293	59.48	74.42	96.69	111.63	148.84	193.38	223.27	260.48	290.36
9	330	66.99	83.82	108.90	125.73	167.64	217.80	251.46	293.37	327.03
10	367	74.50	93.22	121.11	139.83	186.44	242.22	279.65	326.26	363.70
11	404	82.01	102.62	133.32	153.92	205.23	266.64	307.85	359.16	400.36

Height of GS1 DataBar Expanded Stacked by row [imperial units]										
X [inch]		0.0080	0.0100	0.0130	0.0150	0.0200	0.0260	0.0300	0.0350	0.0390
Row	Height (modules)									
2	71	0.568	0.710	0.923	1.065	1.420	1.846	2.130	2.485	2.769
3	108	0.864	1.080	1.404	1.620	2.160	2.808	3.240	3.780	4.212
4	145	1.160	1.450	1.885	2.175	2.900	3.770	4.350	5.075	5.655
5	182	1.456	1.820	2.366	2.730	3.640	4.732	5.460	6.370	7.098
6	219	1.752	2.190	2.847	3.285	4.380	5.694	6.570	7.665	8.541
7	256	2.048	2.560	3.328	3.840	5.120	6.656	7.680	8.960	9.984
8	293	2.344	2.930	3.809	4.395	5.860	7.618	8.790	10.255	11.427
9	330	2.640	3.300	4.290	4.950	6.600	8.580	9.900	11.550	12.870
10	367	2.936	3.670	4.771	5.505	7.340	9.542	11.010	12.845	14.313
11	404	3.232	4.040	5.252	6.060	8.080	10.504	12.120	14.140	15.756

Best Performance
Reduced Performance
Not Recommended

5.6.2.4 Human readable interpretation in GS1 DataBar symbols

For human readable interpretation rules see section [4.14](#). For HRI rules specific to regulated healthcare retail consumer trade items, see section [4.14.1](#).

5.6.2.5 Data transmission and symbology identifier prefixes

5.6.2.5.1 Default transmission mode

The GS1 system requires the use of symbology identifiers. GS1 DataBar family symbols are normally transmitted using symbology identifier prefix "]e0" (see section [5.1.2](#)). For example, a GS1

DataBar symbol encoding AI (01) element string 10012345678902 produces the transmitted data string "]e00110012345678902." Data transmission follows the rules for Encoding/Decoding element strings in GS1 symbologies using GS1 Application Identifiers (see Appendix [5.9](#))

If a 2D Composite Component accompanies a GS1 DataBar family linear symbol, the AI element string data from the 2D Composite Component immediately follows the linear component's data. However, readers have an option to transmit only the linear component data and ignore the 2D Composite Component.

5.6.2.5.2 GS1-128 symbol emulation mode

Readers also have an option for GS1-128 symbol emulation mode. This mode emulates the GS1-128 symbology for data transmission. This mode is used for applications programmed for GS1-128 but not yet programmed to recognise the symbology identifier prefix "]e0." The symbology identifier for GS1-128 emulation mode is "]C1." GS1 DataBar Expanded symbols that exceed 48 data characters are transmitted as two messages so as not to exceed the maximum GS1-128 symbol message length. Each of the two messages has a symbology identifier prefix of "]C1" and does not exceed 48 data characters. The two messages are split at a boundary between two element strings. This mode is inferior to the normal transmission mode as message integrity may be lost when a message is split.

5.6.2.6 Width of a module (X-dimension)

The range of the X-dimension will be defined by the application specification, having due regard to the availability of equipment for the production and reading of symbols and complying with the general requirements of the application. Symbol specifications are subject to change at the application standards level and are governed by the scanner operational environment decision tree in section [5.5.2.6.1](#).

The X-dimension SHALL be constant throughout a given symbol.

5.6.2.7 Height of symbol

The height of a symbol is a multiple of the X-dimension defined by the type of GS1 DataBar symbology given in sections [5.6.2.1.1](#), [5.6.2.1.2](#), [5.6.2.1.3](#), [5.6.2.1.4](#), [5.6.2.2](#), [5.6.2.3.1](#), and [5.6.2.3.2](#). Symbol Specifications are subject to change at the application standards level and are governed by the scanner operational environment decision tree in section [5.5.2.6.1](#).

5.6.3 Print quality grade

The International Standard *ISO/IEC 15416* methodology is used for measuring and grading the GS1 DataBar family of symbols. The *ISO/IEC 15416* print quality specification is functionally identical to the older ANSI and CEN print quality specifications. The print quality grade is measured by verifiers that comply with the standard. The grade includes a grade level, measuring aperture, and the wavelength of light used for the measurement.

Symbol specifications are subject to change at the application standards level and are governed by the scanner operational environment decision tree in section [5.5.2.6.1](#). For most applications, the minimum quality grade for GS1 DataBar symbols is:

1.5 / 06 / 660

Where

- 1.5 is the overall symbol quality grade.
- 06 is the measuring aperture reference number (corresponding to a 0.15 millimetre or 0.006 inch diameter aperture).
- 660 is the peak response wavelength in nanometres.

In addition to the minimum print quality grade, all elements in the row separator patterns SHOULD be visually distinguishable.

5.6.4 Advice for selecting the symbology

Any use of GS1 DataBar should comply with GS1 system global application guidelines. GS1 DataBar is not meant to replace other GS1 system symbologies. Existing applications that are satisfactorily utilising EAN/UPC symbols, ITF-14 symbols, or GS1-128 symbols should continue to use them.

 **Note:** Scanning systems that need to read GS1 DataBar symbols must be appropriately programmed.

If GS1 DataBar is used on items that will be read by omnidirectional slot scanners, then GS1 DataBar Omnidirectional, GS1 DataBar Stacked Omnidirectional, GS1 DataBar Expanded or GS1 DataBar Expanded Stacked SHOULD be used. If only an AI (01) is to be encoded, then GS1 DataBar Omnidirectional or GS1 DataBar Stacked Omnidirectional SHOULD be used. The selection of one or the other depends on the aspect ratio of the area available for the symbol.

If supplementary GS1 Application Identifier (AI) element strings are required or the primary identification has an AI other than AI (01), then GS1 DataBar Expanded or GS1 DataBar Expanded Stacked must be used. The selection of one or the other depends on the width of the print head or the area available for the symbol.

When using GS1 DataBar Expanded or GS1 DataBar Expanded Stacked symbols to encode the Global Trade Item Number (GTIN), any required additional data SHOULD be included within the same symbol.

If GS1 DataBar is used on small items that do not need omnidirectional scanning capability, then GS1 DataBar Stacked, GS1 DataBar Limited, or GS1 DataBar Truncated SHOULD be used. GS1 DataBar Limited cannot be used to encode a GTIN-14 data structure with an indicator value greater than 1. Otherwise GS1 DataBar Truncated or GS1 DataBar Stacked must be used. GS1 DataBar Stacked is the smallest symbol; however, as the heights of both rows are very low, it is harder to scan and cannot be used with wand scanners. If space is available, GS1 DataBar Limited can be used for number structures that it can encode. Otherwise GS1 DataBar Truncated SHOULD be used for GTIN-14 data structures with an indicator value greater than 1.

If the symbol is a GS1 DataBar Composite symbol, then using a wider GS1 DataBar symbol such as GS1 DataBar Truncated instead of GS1 DataBar Limited may be preferable because the wider companion 2D Composite Component may result in a GS1 DataBar Composite symbol of lower overall height even though the GS1 DataBar component itself is slightly taller.

If the data capacity in a two-column or three-column CC-B 2D Composite Component is inadequate to encode the required 2D component's data message, then the linear component can be changed to increase the number of columns of the companion CC-B component. This will increase the maximum data capacity of the CC-B component as shown in the figure below.

Figure 5.6.4-1. Data capacity of CC-B

Number of CC-B columns	Used with	Maximum numeric characters	Maximum alpha characters
2	GS1 DataBar Stacked GS1 DataBar Stacked Omnidirectional	95	55
3	GS1 DataBar Limited	219	127
4	GS1 DataBar Omnidirectional GS1 DataBar Expanded GS1 DataBar Expanded Stacked	338	196

5.7 Two dimensional barcodes – GS1 DataMatrix symbology

5.7.1 Introduction

This section of the *GS1 General Specifications* addresses some of the technical aspects of the two-dimensional barcode symbology called GS1 DataMatrix. GS1 DataMatrix is a standalone, two-dimensional matrix symbology that is made up of square modules arranged within a perimeter finder pattern. Unlike a Composite Component symbol (see section [5.8.1](#)), GS1 DataMatrix does not require a linear symbol. GS1 DataMatrix has been used in the public domain since 1994.

This section provides only a brief technical description and overview of the GS1 DataMatrix symbology. A more detailed technical specification can be found in the International Standard *ISO/IEC 16022*. The GS1 system has adopted GS1 DataMatrix partly because, like GS1 QR Code, GS1 DataMatrix can encode GS1 system data structures and offers other technical advantages. Its compact design and the existence of various production methods that accommodate placing the symbology onto various substrates offer certain advantages over other symbologies currently in the GS1 system.

Data Matrix ISO version ECC 200 is the only version that supports GS1 system data structures, including Function 1 Symbol Character (FNC1). The ECC 200 version of Data Matrix uses Reed-Solomon error correction, and this feature helps correct for partially damaged symbols. In the remainder of this section, the ECC 200 version of Data Matrix is assumed when the symbology is described as GS1 DataMatrix. This version of Data Matrix is similar in stability to ISO versions of current GS1 system symbologies.

Implementation of GS1 DataMatrix SHALL be done per approved GS1 system application guidelines. This section will not describe the specific applications. The user needs to refer to specific application standards and guidelines in other sections of these *GS1 General Specifications* as they are approved for use. However, some of the production processes that are used to produce GS1 DataMatrix symbols are as follows:

- Direct part marking, such as is done by dot peening on items, such as automotive, aircraft metal parts, medical instruments, and surgical implants.
- Laser or chemically etched parts with low contrast or light marked elements on a dark background (e.g., circuit boards and electronic components, medical instruments, surgical implants).
- High-speed ink jet printed parts and components where the marked dots cannot form a scannable linear symbol.
- Very small items that require a symbology with a square aspect ratio and/or cannot be marked within the allocated packaging space by existing GS1 DataBar and Composite symbols.
- Use with B2C Extended Packaging applications.

GS1 DataMatrix symbols are read by two-dimensional imaging scanners or vision systems. Most other scanners that are not two-dimensional imagers cannot read GS1 DataMatrix. GS1 DataMatrix symbols are restricted for use with applications that will involve imaging scanners throughout the supply chain.

5.7.2 GS1 DataMatrix features and symbol basics

Figure 5.7.2-1. GS1 DataMatrix symbol



- Figure 5.7.2–1 represents a GS1 DataMatrix symbol with 20 rows and 20 columns (including the perimeter finder pattern but not including Quiet Zones).
- GS1 DataMatrix solid “L” shaped finder or alignment pattern is one module wide.
- GS1 DataMatrix Quiet Zone is one module wide on all four sides. As with other barcode Quiet Zones, do not print in this area.
- ECC 200 symbols can always be recognised from older versions of Data Matrix because the corner opposite the middle of the finder pattern is a zero module or white in normal print.
- For square GS1 DataMatrix symbols, only an even number of rows and columns exist. Depending on data requirements, symbols can range from 10 row by 10 columns (10 x10) to 144x144 (including finder pattern but not the Quiet Zone).
- For normal printing, a module is one X by one X in dimension. Representation of data: A dark module is a binary one and a light module is a binary zero (or a light module is a binary one and a dark module is a binary zero for a symbol with reflectance reversal).
- ECC 200 (ECC = Error Checking and Correction) that uses Reed-Solomon error correction. Figure 5.7.3.2–1 ECC 200 Square Symbol attributes, shows the fixed amounts of error correction associated for each allowable Data Matrix symbol size.
- FNC1 for GS1 system compatibility SHALL be encoded at the beginning of the data string. When a separator character is needed at the end of an element string, either the Function 1 Symbol Character (FNC1) or the control character <GS> (ASCII value 29 (decimal), 1D (hexadecimal)) SHALL be used and SHALL be represented in the transmitted message by control character <GS> (ASCII value 29 (decimal), 1D (hexadecimal)).
- Encodable character set:
 - The GS1 system requires that only the subset of *ISO/IEC 646 International Reference Version* defined in these *GS1 General Specifications* be used for GS1 Application Identifier (AI) element strings. Refer to [Figure 7.11-1](#) for the allowed encodable character set.
- Data characters per symbol (for the maximum symbol size):
 - Alphanumeric data: up to 2335 characters.
 - Eight-bit byte data: 1556 characters.
 - Numeric data: 3116 digits.
- Large, square ECC symbols (at least 32 X32) will include alignment patterns to separate the data regions.
- Code type: matrix (Composite Component is a stacked type).
- Orientation independence: Yes (requires a two-dimensional imaging scanner).
- Summary of additional features inherent or optional in GS1 DataMatrix:
 - Reflectance reversal: (Inherent) Symbols can be read when marked so that the image is either dark on light or light on dark.
 - Rectangular symbols: Six symbol formats are specified in a rectangular form.
 - Extended Channel Interpretation (ECI) capability allows GS1 DataMatrix to encode data from other alphabets.

5.7.3 GS1 DataMatrix symbology

The technical description of GS1 DataMatrix contained within this section provides additional information based on *ISO technical specification 16022*, and it is provided as a further aid in the development of specific applications. GS1 DataMatrix symbols shown in the following subsections have been magnified to show detail.

5.7.3.1 Square and rectangular formats

GS1 DataMatrix may be printed in a square or rectangular format. The square format is usually used as it has a larger range of sizes and is the only format available for symbols encoding a large amount of data. The largest rectangular symbol can encode 98 digits, while the largest square symbol can encode 3,116 digits. An enlarged rectangular symbol and an equivalent square symbol are shown in the figure below.

Figure 5.7.3.1-1. Rectangular and square GS1 DataMatrix symbols
(Specific applications are not used in the data encodation.
Both symbols contain the same data)

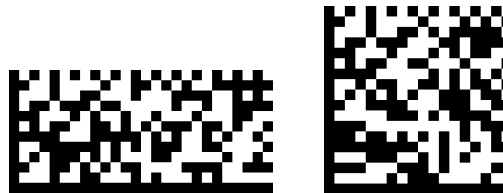

5.7.3.2 GS1 DataMatrix symbol sizes

GS1 DataMatrix symbology has multiple sizes to match various data content (see figure 5.7.3.2-1). GS1 DataMatrix symbols have 24 sizes of the square format ranging from 10 by 10 modules up to 144 by 144 modules, not including the 1-X surrounding Quiet Zone. The rectangular format has 6 sizes from 8 by 18 modules up to 16 by 48 modules, not including the 1-X surrounding Quiet Zone. GS1 DataMatrix sizes of 52 by 52 or larger have 2 to 10 interleaved blocks of Reed-Solomon error correction codewords.

The term "codeword" is used often to describe attributes concerning the encodation of data into GS1 DataMatrix symbols. *ISO 16022* defines codeword as "A symbol character value. An intermediate level of coding between source data and the graphical encodation in the symbol." Codewords are typically eight bits of data. FNC1, two numerics, and one alpha all take up one codeword each.

Figure 5.7.3.2-1. ECC 200 square symbol attributes (***)

Symbol size (*)		Data region		Mapping	Total		Reed-solomon		Inter-leaved	Data capacity			Error	Max. Correctable
Row	Col	Size	No.	Matrix	Codewords		Block		Blocks	Num. Cap.	Alphanum. Cap.	Byte Cap.	Correction Overhead %	Codeword Error/Erasure
10	10	8x8	1	8x8	3	5	3	5	1	6	3	1	62.5	2/0
12	12	10x10	1	10x10	5	7	5	7	1	10	6	3	58.3	3/0
14	14	12x12	1	12x12	8	10	8	10	1	16	10	6	55.6	5/7
16	16	14x14	1	14x14	12	12	12	12	1	24	16	10	50	6/9
18	18	16x16	1	16x16	18	14	18	14	1	36	25	16	43.8	7/11
20	20	18x18	1	18x18	22	18	22	18	1	44	31	20	45	9/15
22	22	20x20	1	20x20	30	20	30	20	1	60	43	28	40	10/17
24	24	22x22	1	22x22	36	24	36	24	1	72	52	34	40	12/21
26	26	24x24	1	24x24	44	28	44	28	1	88	64	42	38.9	14/25
32	32	14x14	4	28x28	62	36	62	36	1	124	91	60	36.7	18/33
36	36	16x16	4	32x32	86	42	86	42	1	172	127	84	32.8	21/39
40	40	18x18	4	36x36	114	48	114	48	1	228	169	112	29.6	24/45
44	44	20x20	4	40x40	144	56	144	56	1	288	214	142	28	28/53
48	48	22x22	4	44x44	174	68	174	68	1	348	259	172	28.1	34/65
52	52	24x24	4	48x48	204	84	102	42	2	408	304	202	29.2	42/78
64	64	14x14	16	56x56	280	112	140	56	2	560	418	277	28.6	56/106
72	72	16x16	16	64x64	368	144	92	36	4	736	550	365	28.1	72/132
80	80	18x18	16	72x72	456	192	114	48	4	912	682	453	29.6	96/180
88	88	20x20	16	80x80	576	224	144	56	4	1152	862	573	28	112/212

Symbol size (*)		Data region		Mapping	Total		Reed-Solomon		Inter-leaved	Data capacity			Error	Max. Correctable
Row	Col	Size	No.	Size	Data	Error	Data	Error	Blocks	Cap.	Alphanum. Cap.	Byte Cap.	Correction Overhead %	Codeword Error/Erasure
96	96	22x22	16	88x88	696	272	174	68	4	1392	1042	693	28.1	136/260
104	104	24x24	16	96x96	816	336	136	56	6	1632	1222	813	29.2	168/318
120	120	18x18	36	108x108	1050	408	175	68	6	2100	1573	1047	28	204/390
132	132	20x20	36	120x120	1304	496	163	62	8	2608	1954	1301	27.6	248/472
144	144	22x22	36	132x132	1558	620	156	62	8 (**)	3116	2335	1556	28.5	310/590
							155	62	2 (**)					

Figure 5.7.3.2-2. ECC 200 Rectangular symbol attributes (*)**

Symbol size (*)		Data region		Mapping	Total		Reed-Solomon		Inter-leaved	Data capacity			Error	Max. Correctable
Row	Col	Size	No.	Size	Blocks	Cap.	Cap.	Cap.	Blocks	Cap.	Alphanum. Cap.	Byte Cap.	Overhead %	Error/Erasure
8	18	6x16	1	6x16	5	7	5	7	1	10	6	3	58.3	3/+
8	32	6x14	2	6x28	10	11	10	11	1	20	13	8	52.4	5/+
12	26	10x24	1	10x24	16	14	16	14	1	32	22	14	46.7	7/11
12	36	10x16	2	10x32	22	18	22	18	1	44	31	20	45.0	9/15
16	36	14x16	2	14x32	32	24	32	24	1	64	46	30	42.9	12/21
16	48	14x22	2	14x44	49	28	49	28	1	98	72	47	36.4	14/25

(*) Symbol size does not include Quiet Zones.

(**) In the largest symbol (144x144), the first eight Reed-Solomon blocks SHALL be 218 codewords long encoding 156 data codewords. The last two blocks SHALL encode 217 codewords (155 data codewords). All the blocks have 62 error correction codewords.

(***) Equivalent to Table 7 in the international standard *ISO-16022*, second edition, 2006-09-15.

The square format is divided into 4 to 36 data regions for symbols sized 32 by 32 modules and larger. The rectangular format symbols may also be divided into two data regions. Each data region is separated from the other regions by alignment patterns that consist of an alternating pattern of ones and zeroes and a solid line of ones (a dark line when there is no reflectance reversal). Figure 5.7.3.2-3 shows a four-segment square symbol on the left and a two-segment rectangular symbol on the right, each with hypothetical data shown to create the effect.

Figure 5.7.3.2-3. Segmented GS1 DataMatrix symbols: Square and rectangular formats
(sizes of these GS1 DataMatrix symbols are larger than what would be used in a typical application so that typical alignment patterns can be easily seen.)

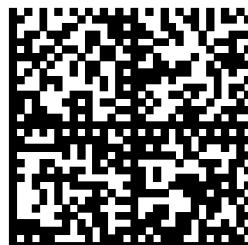

5.7.3.3 Data transmission and symbology identifier prefixes

The GS1 system requires the use of symbology identifiers. GS1 DataMatrix uses the symbology identifier of "]d2" (see figure 5.7.3.3-1) for GS1 system compliant symbols that have a leading FNC1 character. This indicates that GS1 Application Identifier (AI) data is encoded equivalent to the symbology identifier "]C1" for GS1-128 symbols and "]e0" for GS1 DataBar and Composite symbols. For more information on symbology identifiers, see the International standard *ISO/IEC 15424 Information technology – Automatic identification and data capture techniques – Data Carrier Identifiers*.

For example, a GS1 DataMatrix symbol encoding AI (01) element string 10012345678902 produces the transmitted data string "]d20110012345678902." Data transmission follows the same principles that apply to the concatenation of AI element strings in any GS1 barcode that encodes GS1 Application Identifiers (see section 7.8).

Figure 5.7.3.3-1. Symbology identifier for Data Matrix ECC 200

	Message content	Separator
]d2	Standard AI element strings	None

5.7.3.4 Width and height of a module (X)

The range of the X-dimensions will be defined by the application specification, having due regard to the availability of equipment for the production and reading of symbols and complying with the general requirements of the application.

The X-dimension SHALL be constant throughout a given symbol. The X-dimension applies to both the width and height of the modules.

5.7.3.5 Symbol quality grade

The International Standard *ISO/IEC 15415 Information technology - Automatic identification and data capture techniques – Bar code symbol print quality test specification - Two-dimensional symbols methodology* SHALL be used for measuring and grading GS1 DataMatrix. The print quality grade is measured by verifiers that comply with the standard. The grade includes a grade level, measuring aperture, the wavelength of light used for the measurement, and the illumination angle relative to the symbol.

A symbol grade is only meaningful if it is reported in conjunction with the illumination and aperture used. It is shown in the format grade/aperture/light/angle, where:

- **"grade"** is the overall symbol grade as defined in *ISO/IEC 15415 Information technology - Automatic identification and data capture techniques – Bar code symbol print quality test specification - Two-dimensional symbols* (e.g., the arithmetic mean to one decimal place of the Scan Reflectance Profile or scan grades). For GS1 DataMatrix, the grade number may be followed by an asterisk (*) which indicates that the surroundings of the symbol contain extremes of reflectance that may interfere with reading. For most applications, this should be specified as causing the symbol to fail.
- **"aperture"** is the diameter in thousandths of an inch (to the nearest thousandth) of the synthetic aperture defined in *ISO/IEC 15415 Information technology - Automatic identification and data capture techniques – Bar code symbol print quality test specification - Two-dimensional symbols*.
- **"light"** defines the illumination: A numeric value indicates the peak light wavelength in nanometres (for narrow band illumination); the alphabetic character W indicates that the symbol has been measured with broadband illumination (white light) the spectral response characteristics of which must imperatively be defined or have their source specification clearly referenced.
- **"angle"** is an additional parameter defining the angle of incidence (relative to the plane of the symbol) of the illumination. It SHALL be included in the reporting of the overall symbol grade when the angle of incidence is other than 45 degrees. Its absence indicates that the angle of incidence is 45 degrees.

-  **Note:** This international standard provides for 30 degrees and 90 degrees illumination in addition to the default 45 degrees.

The aperture is normally specified as being 80% of the minimum X-dimension allowed for the application. The printing method must produce the GS1 DataMatrix "L" pattern with gaps between the dots less than 25% of the specified aperture. If symbols with greater than the minimum X dimension are allowed by the application, the same absolute maximum gap dimension must be maintained.

Examples:

- 2.8/05/660 would indicate that the average of the grades of the Scan Reflectance Profiles, or of the scan grades, was 2.8 when these were obtained with the use of a 0.125 millimetre aperture (ref. no. 05) and a 660 nanometre light source, incident at 45 degrees.
- 2.8/10/W/30 would indicate the grade of a symbol intended to be read in broadband light, measured with light incident at 30 degrees and using a 0.250 millimetre aperture (ref. no. 10), but would need to be accompanied either by a reference to the application specification defining the reference spectral characteristics used for measurement or a definition of the spectral characteristics themselves.
- 2.8/10/660* would indicate the grade of a symbol measured using a 0.250 millimetre aperture (ref. no. 10), and a 660 nanometre light source, and indicates the presence of a potentially interfering extreme reflectance value in the surroundings of the symbol.

Recommended symbol grades for GS1 DataMatrix are identified in individual applications in section [5.5](#).

5.7.3.6 Advice for selecting the symbology

Any use of GS1 DataMatrix should comply with GS1 system global application guidelines and be restricted to those applications defined by the GS1 system for GS1 DataMatrix. GS1 DataMatrix will not replace other GS1 system symbologies. Existing applications that are satisfactorily utilising EAN/UPC symbols, ITF-14 symbols, GS1-128 symbols, GS1 DataBar symbols, or Composite symbols should continue to use them.

When using GS1 DataMatrix symbols to encode the Global Trade Item Number (GTIN), any required additional data SHOULD be included within the same symbol.

-  **Note:** Scanning systems that need to read GS1 DataMatrix symbols must be 2D imaging scanners and be appropriately programmed to read the GS1 system version of Data Matrix or ECC 200.

5.7.3.7 Human readable interpretation of GS1 DataMatrix symbols

For human readable interpretation rules see section [4.14](#). For HRI rules specific to regulated healthcare retail consumer trade items, see section [4.14.1](#).

5.8 Composite barcodes

5.8.1 Composite symbology introduction

The Composite symbology integrates both a GS1 system linear symbol and a 2D Composite Component as a single symbology. There are three types of Composite symbols A, B and C, each with different encoding rules. The encoder model is designed to automatically select the appropriate type and optimise.

The linear component encodes the item's primary identification. The adjacent 2D Composite Component encodes supplementary data, such as a batch number and expiration date. The Composite symbol always includes a linear component so that the primary identification is readable by all scanning technologies. The Composite symbol always includes a multi-row 2D Composite Component that can be read with linear- and area-CCD scanners, and with linear and rastering laser scanners.

The Composite symbology is described in the *Association for Automatic Identification and Mobility AIM ITS 99-002 - International Symbology Specification - Composite Symbology*.

5.8.1.1 Composite symbology characteristics

The characteristics of the Composite symbology are:

- Encodable character set:
 - Both linear and 2D components encode a subset of *ISO/IEC 646*. Refer to [Figure 7.11-1](#) for the allowed encodable character set.
 - The Function 1 Symbol Character (FNC1), and a Symbol Separator character.
- Symbol character structure: Various (n,k) symbol characters are used in accordance with the underlying symbology of the selected linear and 2D Composite Components of the symbol.
- Code type:
 - Linear component: continuous, linear barcode symbology.
 - 2D Composite Component: continuous, multi-row barcode symbology.
- Maximum numeric data capacity:
 - Linear component:
 - GS1-128 symbol: up to 48 digits.
 - EAN/UPC symbol: 8, 12, or 13 digits.
 - GS1 DataBar Expanded symbol: up to 74 digits.
 - Other GS1 DataBar symbols: 16 digits.
 - 2D Composite Component:
 - CC-A: up to 56 digits.
 - CC-B: up to 338 digits.
 - CC-C: up to 2,361 digit.
- Error detection and correction:
 - Linear component: a modulo check value for error detection.
 - 2D Composite Component: a fixed or variable number of Reed-Solomon error correction codewords, depending upon the specific 2D Composite Component.
- Character self-checking.
- Bi-directionally decodable.

5.8.1.2 Additional features

The following is a summary of additional Composite symbology features:

- Data compaction: The 2D Composite Components utilise a bit-oriented compaction mode designed to encode data efficiently using GS1 Application Identifiers (AIs).
- Component linkage: The 2D Composite Component of each Composite symbol contains a linkage flag, which indicates to the reader that no data shall be transmitted unless the associated linear component is also scanned and decoded. All linear components except EAN/UPC symbols also contain an explicit linkage flag.
- GS1-128 symbol emulation: Readers set to the GS1-128 symbol emulation mode transmit the data encoded within the Composite symbol as if the data were encoded in one or more GS1-128 symbols.
- A symbol separator character: A flag character to support future applications that instructs the reader to terminate transmission of the message at that point and to transmit the remaining data as a separate message
- 2D Composite Component escape mechanism: A mechanism to support future GS1 system applications that require characters beyond the *ISO/IEC 646* character subset defined for GS1 Application Identifier (AI) element string data (see [Figure 7.11-1](#)).

5.8.2 Symbol structure

Each Composite symbol consists of a linear component and a multi-row 2D Composite Component. The 2D Composite Component is printed above the linear component. The two components are separated by a separator pattern. Up to 3X of light space is permitted between the separator pattern and 2D Composite Component to facilitate printing the two components separately; however, if the two components are printed at one time, the nominal alignment is followed as shown in the figure below.

Figure 5.8.2-1. GS1 DataBar Limited Composite symbol with CC-A



(01)13112345678906(17)010615(10)A123456

In figure 5.8.2-1, the AI (01) Global Trade Item Number (GTIN) is encoded in the GS1 DataBar Limited linear component. The AI (17) expiration date and the AI (10) lot number are encoded in the CC-A 2D Composite Component.

The linear component is one of the following:

- A member of the EAN/UPC symbology (EAN-13, EAN-8, UPC-A, or UPC-E).
- A member of the GS1 DataBar family.
- A GS1-128 symbol.

The choice of linear component determines the name of the Composite symbol, such as an EAN-13 Composite symbol, or a GS1-128 Composite symbol.

The 2D Composite Component (abbreviated as CC) is chosen based on the selected linear component and on the amount of supplementary data to be encoded. The three 2D Composite Components, listed in order of increasing maximum data capacity, are:

- CC-A: a variant of MicroPDF417.
- CC-B: a MicroPDF417 symbol with new encoding rules.
- CC-C: a PDF417 symbol with new encoding rules.

Figure 5.8.2-2. GS1-128 Composite symbol with CC-C

(01)03812345678908(10)ABCD123456(410)3898765432108

In figure 5.8.2-2, the AI (01) GTIN is encoded in the GS1-128 symbol linear component. The AI (10) lot number and the AI (410) ship-to location are encoded in the CC-C 2D Composite Component. Based upon the width of the linear component, a choice of "best-fit" 2D Composite Component is specified. Figure 5.8.2-3 lists all of the permissible combinations.

Figure 5.8.2-3. Permissible combinations of linear and 2D Composite Components

Linear component	CC-A/CC-B	CC-C
UPC-A and EAN-13	Yes (4-columns)	No
EAN-8	Yes (3-columns)	No
UPC-E	Yes (2-columns)	No
GS1-128	Yes (4-columns)	Yes (variable width)
GS1 DataBar Omnidirectional and GS1 DataBar Truncated	Yes (4-columns)	No
GS1 DataBar Stacked and GS1 DataBar Stacked Omnidirectional	Yes (2-columns)	No
GS1 DataBar Limited	Yes (3-columns)	No
GS1 DataBar Expanded and GS1 DataBar Expanded Stacked	Yes (4-columns)	No

5.8.2.1 CC-A structure

CC-A is a variant of MicroPDF417 with a unique combination of row address patterns (RAP). It is the smallest of the 2D Composite Components and can encode up to 56 digits. It has from 3 to 12 rows and 2 to 4 columns.

Each row is a minimum of 2X high (where X is the width of a module, narrow bar, or space). A 1X high minimum separator pattern is positioned between the linear component and 2D Composite Component. (A different separator pattern, 6X high, is used in Composite symbols with EAN/UPC linear components).

Each column contains one $n,k = 17,4$ data or error correction character (codeword) per row (n is the number of modules, and k is the number of bars and also the number of spaces). So the width of a codeword is 17X.

In addition to the codeword columns, CC-A has two or three $n,k = 10,3$ RAP columns that encode the row numbers (each 10X wide). The rightmost RAP column is terminated on the right by a 1X bar, so it is 11X instead of 10X wide.

Each row also requires a 1X Quiet Zone at each end. There is no Quiet Zone required above CC-A. The separator pattern is printed directly above the linear component and no Quiet Zone is required below the CC-A.

The two-column and three-column CC-A versions have two RAP columns, and the four-column CC-A version has three RAP columns, as shown in the figure below.

Figure 5.8.2.1-1. CC-A column structures

Two-column CC-A structure

Quiet Zone	RAP column	Codeword column	Codeword column	RAP column	Quiet Zone
------------	------------	-----------------	-----------------	------------	------------

Three-column CC-A structure

Quiet Zone	Codeword column	RAP column	Codeword column	Codeword column	RAP column	Quiet Zone
------------	-----------------	------------	-----------------	-----------------	------------	------------

Four-column CC-A structure

Quiet Zone	RAP column	Codeword column	Codeword column	RAP column	Codeword column	Codeword column	RAP column	Quiet Zone
------------	------------	-----------------	-----------------	------------	-----------------	-----------------	------------	------------

Figure 5.8.2.1-2 lists all possible column and row combinations for CC-A. It also shows the capacity and size of the 2D Composite Components. For example, a two-column, five-row CC-A would be 57X wide (including 1X for the extra right-most guard bar) by 10X high (not including the separator pattern). With an X-dimension of 0.254 millimetre (0.0100 inch), it would be 14.48 millimetres (0.57 inch) wide by 2.54 millimetre (0.100 inch) high.

Figure 5.8.2.1-2. CC-A Row and column sizes

Number of data columns (c)	Number of rows (r)	Total CWs in data region	Number of EC CWs (k)	Percent of CWs for ec	Number of CWs for data	Max alpha chars	Max digits	Component width, in X (see note 1)	Component height, in X (see note 2)
2	5	10	4	40.00%	6	8	16	57	10
2	6	12	4	33.33%	8	12	22	57	12
2	7	14	5	35.71%	9	13	24	57	14
2	8	16	5	31.25%	11	17	30	57	16
2	9	18	6	33.33%	12	18	33	57	18
2	10	20	6	30.00%	14	22	39	57	20
2	12	24	7	29.17%	17	26	47	57	24
3	4	12	4	33.33%	8	12	22	74	8
3	5	15	5	33.33%	10	15	27	74	10
3	6	18	6	33.33%	12	18	33	74	12
3	7	21	7	33.33%	14	22	39	74	14
3	8	24	7	29.17%	17	26	47	74	16
4	3	12	4	33.33%	8	12	22	101	6
4	4	16	5	31.25%	11	17	30	101	8
4	5	20	6	30.00%	14	22	39	101	10
4	6	24	7	29.17%	17	26	47	101	12
4	7	28	8	28.57%	20	31	56	101	14

CW = Codeword; EC = Error correction

Note 1: Includes a 1X Quiet Zone on each side.

Note 2: Assumes row height = 2X; does not include separator pattern.

5.8.2.2 CC-B structure

CC-B is a MicroPDF417 symbol uniquely identified by the codeword 920 as the first codeword in the symbol. Encoding systems normally automatically select CC-B when the data to be encoded exceeds the capacity of CC-A. CC-B can encode up to 338 digits. It has from 10 to 44 rows and 2 to 4 columns.

Each row is a minimum of 2X high (where X is the width of a module, narrow bar or space). A 1X high minimum separator pattern is positioned between the linear component and 2D Composite Component. (A different separator pattern, 6X high, is used in Composite symbols with EAN/UPC linear components).

Each column contains one $n,k = 17,4$ data or error correction character (codeword) per row (where n is the number of modules, and k is the number of bars and also the number of spaces). So the width of a codeword is 17X.

In addition to the codeword columns, CC-B has two or three $n,k = 10,3$ row address pattern (RAP) columns that encode the row numbers (each 10X wide). The rightmost RAP column is terminated on the right by a 1X bar, so it is 11X instead of 10X wide.

Each row also requires a 1X Quiet Zone on each end. There is no Quiet Zone required above CC-B. The separator pattern is printed directly above the linear component, and no Quiet Zone is required below the CC-B.

The two-column CC-B version has two RAP columns and the three- and four-column CC-B versions have three RAP columns, as shown in the figure below.

Figure 5.8.2.2-1. CC-B column structures

Two-column CC-B structure

Quiet Zone	RAP column	Codeword column	Codeword column	RAP column	Quiet Zone
------------	------------	-----------------	-----------------	------------	------------

Three-column CC-B structure

Quiet Zone	RAP column	Codeword column	RAP column	Codeword column	Codeword column	RAP column	Quiet Zone
------------	------------	-----------------	------------	-----------------	-----------------	------------	------------

Four-column CC-B structure

Quiet Zone	RAP column	Codeword column	Codeword column	RAP column	Codeword column	Codeword column	RAP column	Quiet Zone
------------	------------	-----------------	-----------------	------------	-----------------	-----------------	------------	------------

CC-B differs from CC-A in the three-column structure in that CC-B has a third RAP column on the left end that is missing in CC-A.

Figure 5.8.2.2-2 lists all the possible column and row combinations for CC-B. It also shows the capacity and size of the 2D Composite Components. For example a four-column, 10-row CC-B would be 101X wide by 20X high (not including the separator pattern). With an X-dimension of 0.254 millimetre (0.0100 inch), it would be 25.65 millimetres (1.010 inches) wide by 5.08 millimetres (0.200 inch) high.

Figure 5.8.2.2-2. CC-B row and column sizes

Number of data columns (c)	Number of rows (r)	Total CWs in data region	Number of EC CWs (k)	Percent of CWs for EC	Number of non-EC CWs	Number of CWs for data (note 1)	Max alpha chars	Max digits	CC-B width, in X (see note 2)	CC-B height, in X (see note 3)
2	17	34	10	29	24	22	34	59	57	34
2	20	40	11	28	29	27	42	73	57	40
2	23	46	13	28	33	31	48	84	57	46
2	26	52	15	29	37	35	55	96	57	52
3	15	45	21	47	24	22	34	59	84	30

Number of data columns (c)	Number of rows (r)	Total CWs in data region	Number of EC CWs (k)	Percent of CWs for EC	Number of non-EC CWs	Number of CWs for data (note 1)	Max alpha chars	Max digits	CC-B width, in X (see note 2)	CC-B height, in X (see note 3)
3	20	60	26	43	34	32	50	86	84	40
3	26	78	32	41	46	44	68	118	84	52
3	32	96	38	40	58	56	88	153	84	64
3	38	114	44	39	70	68	107	185	84	76
3	44	132	50	38	82	80	127	219	84	88
4	10	40	16	40	24	22	34	59	101	20
4	12	48	18	38	30	28	43	75	101	24
4	15	60	21	35	39	37	58	100	101	30
4	20	80	26	33	54	52	82	141	101	40
4	26	104	32	31	72	70	111	192	101	52
4	32	128	38	30	90	88	139	240	101	64
4	38	152	44	29	108	106	168	290	101	76
4	44	176	50	28	126	124	196	338	101	88

CW = Codeword; EC = Error correction

Note 1: Excludes EC codewords and 2 codewords to define CC-B encodation.

Note 2: Including 1X Quiet Zones on either side.

Note 3: Assumes $Y = 2X$; does not include separator pattern.

5.8.2.3 CC-C structure

CC-C is a PDF417 symbol uniquely identified by the codeword 920 as the first codeword in the symbol following the symbol length descriptor. CC-C is only used as a 2D Composite Component within a GS1-128 Composite symbol. It has the greatest data capacity of the Composite symbols, encoding up to 2,361 digits. It has from 3 to 30 rows and 1 to 30 data/EC codeword columns.

Each row is a minimum of 3X high (where X is the width of a module, narrow bar, or space). A 1X high minimum separator pattern is positioned between the linear component and 2D Composite Component.

Each column contains one $n, k = 17, 4$ data or error correction character (codeword) per row (where n is the number of modules, and k is the number of bars and also the number of spaces). So the width of a data/EC codeword is 17X.

In addition to the codeword columns, CC-C has two 17,4 row indicator columns, a 17X wide start pattern, and a 18X wide stop pattern as illustrated in figure 5.8.2.3-1.

Each row also requires a 2X Quiet Zone on each end. There is no Quiet Zone required above CC-C. The separator pattern is printed directly above the linear component, and no Quiet Zone is required below the CC-C.

Figure 5.8.2.3-1. CC-C row structure

Quiet Zone	Start pattern	Left row indicator column	1 to 30 Data/EC codeword columns	Right row indicator column	Stop pattern	Quiet Zone
------------	---------------	---------------------------	----------------------------------	----------------------------	--------------	------------

CC-C is normally printed with the number of columns that will result in a width nearly matching the width of the GS1-128 symbol linear component. However, as an option, the user may specify a wider CC-C to be printed. This reduces the height of the 2D Composite Component. A lower Composite symbol may be needed to fit in a height-restricted application. A wider CC-C may also be required if the amount of data does not fit in the default width CC-C.

5.8.2.4 Special compressed element string sequences

While 2D Composite Components can encode any sequence of GS1 Application Identifier (AI) element strings up to the maximum capacity of the component, certain sequences of AI element strings have been selected for special compression in 2D Composite Component symbols. If the application requires the use of the AI element strings in one of these sequences, and they are used in the predefined sequence, a smaller symbol will result.

For special compression to be performed, the AI element string sequence must occur at the start of the 2D Composite Component's data. Other AI element strings may be added following the sequence. The AI element strings selected for special compression are:

- Production date and lot number: AI (11) production date followed by AI (10) lot number.
- Expiration date and lot number: AI (17) expiration date followed by AI (10) lot number.
- AI (90): AI (90) followed by the element string data starting with an alphabetic character and a digit; AI (90) may be used to encode data identifier data; the AI (90) followed by data in the data identifier format has special compression applied only if it is the start of the first element string.

5.8.3 Human readable interpretation of Composite symbols

For human readable interpretation rules see section [4.14](#). For HRI rules specific to regulated healthcare retail consumer trade items, see section [4.14.1](#).

5.8.4 Data transmission and symbology identifier prefixes

5.8.4.1 Default transmission mode

The GS1 system requires the use of symbology identifiers. Composite symbols are normally transmitted using symbology identifier prefix "je0," with the data from the 2D Composite Component directly appended to that of the linear component. For example, a Composite symbol encoding (01)10012345678902(10)ABC123 produces the data string "je0011001234567890210ABC123" (note that the symbology identifier prefix "je0" is different from the symbology identifier prefix "JE0," which has an uppercase "E" and is used for standard EAN/UPC symbols). However, readers have an option to transmit only the linear component data and ignore the 2D Composite Component.

Data transmission follows the same principles that apply to the concatenation of GS1 Application Identifier (AI) element strings from GS1-128 symbols. If the linear component data ends with a variable length AI element string, the control character <GS> (ASCII value 29 (decimal), 1D (hexadecimal)) is inserted between it and the first character of the data from the 2D Composite Component.

5.8.4.2 GS1-128 Symbol transmission mode

Readers also have an option for GS1-128 symbol emulation mode. This mode emulates the GS1-128 symbology for data transmission. It can be used for applications programmed for GS1-128 symbols but not yet programmed to recognise the symbology identifier prefix "je0." The symbology identifier for GS1-128 symbol emulation mode is "]C1." Composite symbols that exceed 48 data characters are transmitted as two or more messages so as not to exceed the maximum GS1-128 symbol message length. Each of the messages has a symbology identifier prefix of "]C1" and does not exceed 48 data characters. The messages are split at boundaries between element strings. This mode is inferior to the normal transmission mode as message integrity may be lost when a message is split into multiple messages.



Note: When GS1-128 emulation option is enabled in the reader, each data packet (except the data from an EAN/UPC component) SHALL be prefixed with a symbology identifier of "]C1". When transmitting data from GS1 Composite symbols, two separate transmissions from the reader are required. The data from the EAN/UPC component is prefixed with a symbology identifier in accordance with symbology identifier "E". Modifier character values 1 and 2 SHALL NOT be used when transmitting data from GS1 DataBar symbols.

5.8.4.3 Symbol separator character

The 2D Composite Component can encode symbol separator characters as defined in the decoder. This character instructs the reader to terminate the current Composite symbol's data message and transmit the data following the symbol separator as a separate message. This new message will have the symbology identifier prefix of "]e1." This feature will be used for future GS1 system applications such as encoding the mixed contents of a logistical container.

5.8.4.4 2D Composite Component escape mechanism

The CC-B and CC-C also can encode 2D Composite Component escape mechanism codewords. These instruct the reader to terminate the current Composite symbol's data message and transmit the data following the escape mechanism codeword as a separate message. This new message has the symbology identifier prefix of "]e2" for standard data message. The codewords following the escape mechanism codeword are encoded and decoded using the standard PDF417 encoding defined in *ISO/IEC 15438 – Information technology; automatic identification and data capture techniques - Symbology specification - PDF417*. This feature is used for future GS1 system applications that require characters beyond the *ISO/IEC 646* character subset defined for GS1 Application Identifier (AI) element string data (see [Figure 7.11-1](#)).



Note: The protocol for "]e2" corresponds to the protocol defined for PDF417 using symbology identifier "]L2".

5.8.5 Width of a module (X)

The X-dimension of the 2D Composite Component must be the same as that of the associated linear component. Refer to the linear component's X-dimension requirements.

5.8.6 Print quality

The print quality assessment methodology defined in the International Standard *ISO/IEC 15416* is used for measuring and grading the linear components. The ISO print quality specification is functionally identical to the older ANSI and CEN print quality specifications. The print quality grade is measured by verifiers that apply the standard. The print quality grade reported includes a grade level, measuring aperture, and the wavelength of light used for the measurement.

AIM ITS 99-002 – International Symbology Specification - MicroPDF417 and *ISO/IEC 15438* specify the methods for determining the print quality grade of the 2D Composite Components CC-A/B and CC-C respectively. An additional grading parameter unused error correction (UEC) is defined in these specifications.

The minimum quality grade for Composite symbols is:

1.5 / 6 / 660

- Where-

- 1.5 is the overall symbol quality grade.
- 6 is the measuring aperture reference number (corresponding to a 0.15 millimetre or 0.006 inch diameter aperture).
- 660 is the peak response wavelength in nanometres. In addition to the print quality grade, all elements in the separator patterns SHOULD be visually distinguishable.

Both the linear component and the 2D Composite Component must independently achieve the minimum print quality grade.

5.8.7 Advice for selecting a symbology

Any use of the 2D Composite Component SHALL comply with GS1 system global application standards and multiple barcode management practices (see section [4.15](#)). The linear component of a Composite symbol should be selected according to the application rules defined in these *GS1 General Specifications*, but where a choice of linear components is available for the application,

consideration should also be given to the 2D Composite Component options available. A wider linear component will result in a shorter 2D Composite Component and, particularly for CC-B, a higher capacity symbol.

For CC-A and CC-B, the selection of the linear component automatically determines the number of columns of the 2D Composite Component. The selection of CC-A or CC-B is automatically determined by the amount of data to be encoded. CC-A is always used unless the data exceeds its capacity.

When the linear component is a GS1-128 symbol, the user may specify CC-A/B or CC-C. CC-A/B will produce a smaller 2D Composite Component. However, CC-C can increase in width to match the width of the GS1-128 symbol or be selected to be even wider. This may produce a Composite symbol of lower height. CC-C also has a larger data capacity, so it is suitable for applications such as logistics.

5.8.8 Sample Composite symbols

Figure 5.8.8-1. EAN-13 symbol with a four-column CC-A component



Figure 5.8.8-2. UPC-A symbol with a four-column CC-B component



Figure 5.8.8-3. EAN-8 symbol with a three-column CC-A



Figure 5.8.8-4. UPC-E symbol with a two-column CC-A



Figure 5.8.8-5. GS1 DataBar Omnidirectional symbol with a four-column CC-A



Figure 5.8.8-6. GS1 DataBar Stacked symbol with a two-column CC-A



Figure 5.8.8-7. GS1 DataBar Limited symbol with a three-column CC-B



 **Note:** The three-column CC-B is wider than the three-column CC-A shown in figure 5.8.2-1.

Figure 5.8.8-8. GS1 DataBar Expanded symbol with a four-column CC-A



Figure 5.8.8-9. GS1-128 symbol with a four-column CC-A



5.9 Two dimensional barcodes – GS1 QR Code symbology

5.9.1 Introduction

This section of the *GS1 General Specifications* addresses some of the technical aspects of the two-dimensional barcode symbology called GS1 QR Code. GS1 QR Code is a standalone, two-dimensional matrix symbology that is made up of square modules arranged in an overall square pattern, including a unique finder pattern located at three corners of the symbol. Unlike a Composite Component symbol (see section [5.8](#)), GS1 QR Code does not require a linear symbol.

This section provides only a brief technical description and overview of the GS1 QR Code symbology. A more detailed technical specification can be found in *ISO/IEC 18004:2015 Information technology -- Automatic identification and data capture techniques -- QR Code bar code symbology specification*. ISO/IEC QR Code also contains specifications for Micro QR Code, but this symbology is not supported in the GS1 system.

The GS1 system has adopted GS1 QR Code partly because, like GS1 DataMatrix, GS1 QR Code can encode GS1 system data structures and offers other technical advantages. Its compact design and the existence of various production methods that accommodate placing the symbology onto various substrates offer certain advantages over other symbologies currently in the GS1 system.

QR Code supports all GS1 system data structures, including Function 1 Symbol Character (FNC1). QR Code uses Reed-Solomon error correction (four selectable levels of error correction are specified), and this feature helps correct for partially damaged symbols.

Implementation of GS1 QR Code SHALL be done per approved GS1 system application standards. This section will not describe the specific applications. The user needs to refer to specific application standards in other sections of these *GS1 General Specifications* as they are approved for use.

GS1 QR Code symbols are read by two-dimensional imaging scanners or vision systems. Most other scanners that are not two-dimensional imagers cannot read GS1 QR Code. GS1 QR Code symbols are restricted for use with applications that will involve imaging scanners throughout the supply chain.

5.9.2 GS1 QR Code features and symbol basics

GS1 QR Code is a subset of ISO/IEC QR Code that is a matrix symbology with the following characteristics:

Formats:

- QR Code, with full range of capabilities and maximum data capacity.
- Not supported for the GS1 system: Micro QR Code, with reduced overhead, some restrictions on capabilities and reduced data capacity.

Encodable character set

- numeric data: digits 0 - 9
- alphabetic data: upper case letters A - Z
- nine special characters: space \$ % * + - . / :



Note: More information on how to encode the % special character can be found in *ISO/IEC 18004:2015*.

- byte data (default: *ISO/IEC 8859-1*; or other sets as otherwise defined) In byte mode, data is encoded at 8 bits per character. In closed-system national or application-specific implementations of QR Code, an alternative 8-bit character set, for example as defined in an appropriate part of *ISO/IEC 8859*, may be specified for byte mode. When an alternative character set is specified, however, the parties intending to read the QR Code symbols require to be notified of the applicable character set in the application specification or by bilateral agreement.

- Not supported for the GS1 system: Kanji characters (Kanji characters in QR Code can be compacted into 13 bits).

Representation of data:

A dark module is nominally a binary one and a light module is nominally a binary zero. However, reflectance reversal is provided as an option.

Symbol size (not including Quiet Zone):

GS1 QR Code symbols: 21 x 21 modules to 177 x 177 modules (Versions 1 to 40, increasing in steps of four modules per side).

Data characters per symbol

- maximum QR Code symbol size, Version 40-L:
- numeric data: 7,089 characters.
- alphanumeric data: 4,296 characters.
- Byte data: 2,953 characters.
- Kanji data: 1,817 characters (Not supported for the GS1 system).

Selectable error correction:

Four levels of Reed-Solomon error correction (referred to as L, M, Q and H in increasing order of capacity) allowing recovery of:

- L 7% of the symbol codewords.
- M 15% of the symbol codewords.
- Q 25% of the symbol codewords.
- H 30% of the symbol codewords.

Orientation independence:

both rotation and reflection

Figure 5.9.3-1 illustrates a QR Code symbol in normal colour and with reflectance reversal in both normal and mirror image orientations.

5.9.3 Summary of additional features

The use of the following additional features is optional in QR Code; some of these features are not supported for GS1 system use.

Reflectance reversal

Symbols are intended to be read when marked so that the image is either dark on light or light on dark (Figure 5.9.3-1). The specifications in this document are based on dark images on a light background, therefore in the case of symbols produced with reflectance reversal references to dark or light modules should be taken as references to light or dark modules respectively. See note below figure 5.5.2.7.1-2 for more information.

Mirror imaging

The arrangement of modules defined in this International Standard represents the "normal" orientation of the symbol. It is, however, possible to achieve a valid decode of a symbol in which the arrangement of the modules has been laterally transposed. When viewed with the finder patterns at the top left, top right and bottom left corners of the symbol, the effect of mirror imaging is to interchange the row and column positions of the modules. See note below figure 5.5.2.7.1-2 for more information.

Figure 5.9.3-1. Examples of QR Code symbols

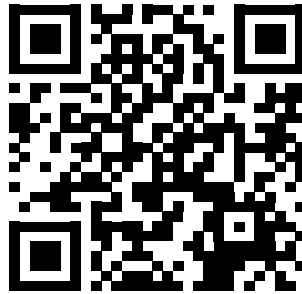

normal orientation and normal reflectance arrangement

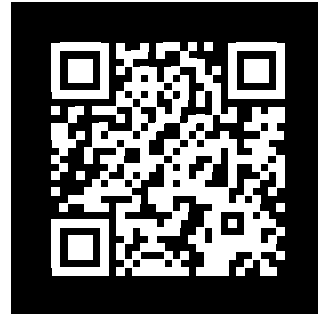

normal orientation and reversed reflectance

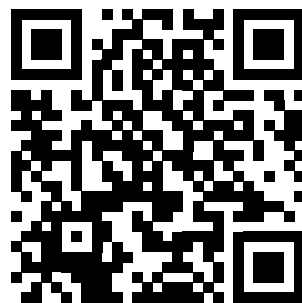

mirror image orientation and normal reflectance arrangement

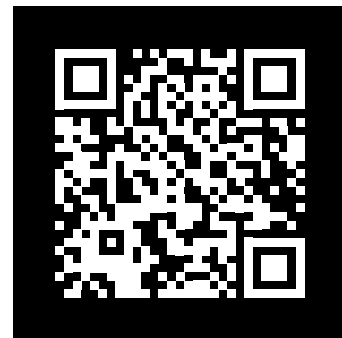

mirror image orientation and reversed reflectance

Not supported for the GS1 system: Structured append

This allows files of data to be represented logically and continuously in up to 16 QR Code symbols. These may be scanned in any sequence to enable the original data to be correctly reconstructed. Structured Append is not available with Micro QR Code symbols.

Not supported for the GS1 system: Extended channel interpretations

This mechanism enables data using character sets other than the default encodable set (e.g. Arabic, Cyrillic, Greek) and other data interpretations (e.g. compacted data using defined compression schemes) or other industry-specific requirements to be encoded.

5.9.4 GS1 QR Code symbology

The technical description of GS1 QR Code contained within this section provides additional information based on *ISO/IEC technical standard 18004:2015* and it is provided as a further aid in the development of specific applications.

5.9.4.1 GS1 QR Code square format

GS1 QR Code is printed in a square format. The square format has a large range of sizes. The largest symbol (177 X 177 modules, Error Correction Level = L) can encode up to 7089 digits or 4296 alphanumeric characters technically, however permissible data is specified by the application standards.

5.9.4.2 GS1 QR Code symbol sizes

GS1 QR Code symbology has multiple sizes to match various data content (see figure 5.9.4.2-1). GS1 QR Code symbols have 40 sizes in a square format ranging from 21 by 21 modules up to 177 by 177 modules, not including the 4-X surrounding Quiet Zone.

The term "codeword" is used often to describe attributes concerning the encodation of data into GS1 QR Code. A codeword is defined as: "A symbol character value. An intermediate level of coding between source data and the graphical encodation in the symbol." Codewords are typically eight bits of data.

Figure 5.9.4.2-1. GS1 QR Code symbol size and data capacity

Version	Modules/ side	Data capacity [codewords]	Version	Modules/ side	Data capacity [codewords]
1	21	26	21	101	1 156
2	25	44	22	105	1 258
3	29	70	23	109	1 364
4	33	100	24	113	1 474
5	37	134	25	117	1 588
6	41	172	26	121	1 706
7	45	196	27	125	1 828
8	49	242	28	129	1 921
9	53	292	29	133	2 051
10	57	346	30	137	2 185
11	61	404	31	141	2 323
12	65	466	32	145	2 465
13	69	532	33	149	2 611
14	73	581	34	153	2 761
15	77	655	35	157	2 876
16	81	733	36	161	3 034
17	85	815	37	165	3 196
18	89	901	38	169	3 362
19	93	991	39	173	3 532
20	97	1 085	40	177	3 706



Note: Symbol size does not include surrounding 4-X Quiet Zones.

Figure 5.9.4.2-2. GS1 QR Code symbol attributes for the first ten versions of the symbol

Version	Error correction level	Number of data codewords	Data capacity			
			Numeric	Alpha- numeric	Byte	Kanji
1	L	19	41	25	17	10
	M	16	34	20	14	8
	Q	13	27	16	11	7
	H	9	17	10	7	4
2	L	34	77	47	32	20
	M	28	63	38	26	16
	Q	22	48	29	20	12
	H	16	34	20	14	8

Version	Error correction level	Number of data codewords	Data capacity			
			Numeric	Alpha-numeric	Byte	Kanji
3	L	55	127	77	53	32
	M	44	101	61	42	26
	Q	34	77	47	32	20
	H	26	58	35	24	15
4	L	80	187	114	78	48
	M	64	149	90	62	38
	Q	48	111	67	46	28
	H	36	82	50	34	21
5	L	108	255	154	106	65
	M	86	202	122	84	52
	Q	62	144	87	60	37
	H	46	106	64	44	27
6	L	136	322	195	134	82
	M	108	255	154	106	65
	Q	76	178	108	74	45
	H	60	139	84	58	36
7	L	156	370	224	154	95
	M	124	293	178	122	75
	Q	88	207	125	86	53
	H	66	154	93	64	39
8	L	194	461	279	192	118
	M	154	365	221	152	93
	Q	110	259	157	108	66
	H	86	202	122	84	52
9	L	232	552	335	230	141
	M	182	432	262	180	111
	Q	132	312	189	130	80
	H	100	235	143	98	60
10	L	274	652	395	271	167
	M	216	513	311	213	131
	Q	154	364	221	151	93
	H	122	288	174	119	74

5.9.4.3 Data transmission and symbology identifier prefixes

The GS1 system requires the use of symbology identifiers. GS1 QR Code uses the symbology identifier of "]Q3" (see figure 5.9.4.3-1) for GS1 system compliant symbols that have a leading FNC1 character. This indicates that GS1 Application Identifier (AI) data is encoded equivalent to the symbology identifier "]C1" for GS1-128 symbols,]d2 for GS1 DataMatrix symbols and "]e0" for GS1 DataBar and Composite symbols. For more information on symbology identifiers, see the International standard *ISO/IEC 15424 Information technology — Automatic identification and data capture techniques — Data Carrier Identifiers*.

For example, a GS1 QR Code symbol encoding AI (01) element string 10012345678902 produces the transmitted data string "]Q30110012345678902." Data transmission follows the same principles that apply to the concatenation of AI element strings in any GS1 barcode that encodes GS1 Application Identifiers (see section 7.8).

Figure 5.9.4.3-1. Symbology identifier for GS1 QR Code

	Message content	Separator
]Q3	Standard AI element strings	None

5.9.4.4 Width and height of a module (X)

The range of the X-dimensions will be defined by the application specification, having due regard to the availability of equipment for the production and reading of symbols and complying with the general requirements of the application.

The X-dimension SHALL be constant throughout a given symbol. The X-dimension SHOULD apply to both the width and height of the modules.

5.9.4.5 Symbol quality grade

The International Standard *ISO/IEC 15415 Information technology - Automatic identification and data capture techniques - Bar code symbol print quality test specification - Two-dimensional symbols methodology* SHALL be used for measuring and grading GS1 QR Code Symbols. The print quality grade is measured by verifiers that comply with the standard. The grade includes a grade level, measuring aperture, the wavelength of light used for the measurement, and the illumination angle relative to the symbol.

A symbol grade is only meaningful if it is reported in conjunction with the illumination and aperture used. It should be shown in the format grade/aperture/light/angle, where:

- **"grade"** is the overall symbol grade as defined in *ISO/IEC 15415 Information technology - Automatic identification and data capture techniques - Bar code symbol print quality test specification - Two-dimensional symbols* (e.g., the arithmetic mean to one decimal place of the Scan Reflectance Profile or scan grades). For GS1 QR Code, the grade number may be followed by an asterisk (*) which indicates that the surroundings of the symbol contain extremes of reflectance that may interfere with reading. For most applications, this should be specified as causing the symbol to fail.
- **"aperture"** is the diameter in thousandths of an inch (to the nearest thousandth) of the synthetic aperture defined in *ISO/IEC 15415 Information technology - Automatic identification and data capture techniques - Bar code symbol print quality test specification - Two-dimensional symbols*.
- **"light"** defines the illumination: A numeric value indicates the peak light wavelength in nanometres (for narrow band illumination); the alphabetic character W indicates that the symbol has been measured with broadband illumination (white light) the spectral response characteristics of which must imperatively be defined or have their source specification clearly referenced.
- **"angle"** is an additional parameter defining the angle of incidence (relative to the plane of the symbol) of the illumination. It SHALL be included in the reporting of the overall symbol grade when the angle of incidence is other than 45 degrees. Its absence indicates that the angle of incidence is 45 degrees.

The aperture is normally specified as being 80% of the minimum X-dimension allowed for the application.

Examples:

- 2.8/05/660 would indicate that the average of the grades of the Scan Reflectance Profiles, or of the scan grades, was 2.8 when these were obtained with the use of a 0.125 millimetre aperture (ref. no. 05) and a 660 nanometre light source, incident at 45 degrees.
- 2.8/10/W/30 would indicate the grade of a symbol intended to be read in broadband light, measured with light incident at 30 degrees and using a 0.250 millimetre aperture (ref. no. 10), but would need to be accompanied either by a reference to the application specification defining the reference spectral characteristics used for measurement or a definition of the spectral characteristics themselves.
- 2.8/10/660* would indicate the grade of a symbol measured using a 0.250 millimetre aperture (ref. no. 10), and a 660 nanometre light source, and indicates the presence of a potentially interfering extreme reflectance value in the surroundings of the symbol.

Recommended symbol grades for GS1 QR Code are identified in individual applications in section [5.5](#).

5.9.4.6 Advice for selecting the symbology

Any use of GS1 QR Code should comply with GS1 system global application standards and be restricted to those applications defined by the GS1 system for GS1 QR Code. GS1 QR Code will not replace other GS1 system symbologies. Existing applications that are satisfactorily utilising EAN/UPC symbols, ITF-14 symbols, GS1-128 symbols, GS1 DataBar symbols, GS1 DataMatrix or GS1 composite symbols should continue to use them.



Note: Scanning systems that need to read GS1 QR Code symbols must be 2D imaging scanners and be appropriately programmed to read the GS1 system versions of *ISO/IEC 18004:2015*.

5.9.4.7 Human readable interpretation of GS1 QR Code symbols

For human readable interpretation rules see section [4.14](#).

5.10 Appendix: Rules for encoding/decoding element strings in GS1 symbologies using GS1 Application Identifiers

5.10.1 The basic structure of GS1 barcodes using GS1 Application Identifiers and concatenation

GS1 barcode symbologies that use GS1 Application Identifiers generally have a particular symbol character to indicate that the data is encoded according to the GS1 Application Identifier rules. For example, the GS1-128 symbology uses the Function 1 Symbol Character (FNC1) in the position immediately following the start character. This character pattern is reserved for GS1 system applications worldwide and makes it possible to distinguish GS1-128 barcodes from Code 128 symbols encoding non-GS1 data.

Figure 5.10.1-1. Example GS1-128 barcode structure

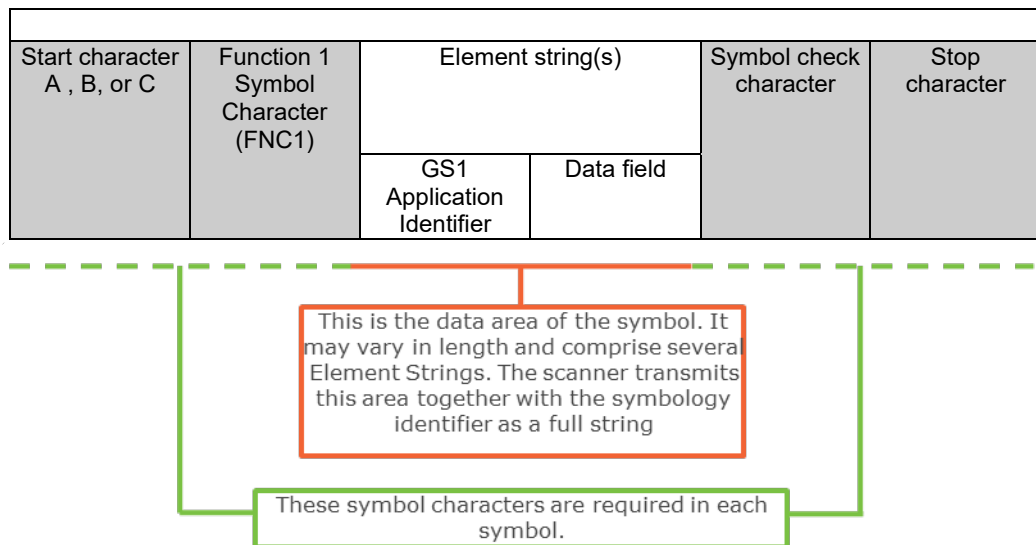

All GS1 barcode symbologies that use GS1 Application Identifiers allow several element strings to be encoded in one barcode, a process called concatenation. Concatenation is advantageous because it means that the symbol's double start, symbol check and stop characters are only needed once, and the space required for the symbol is smaller than when separate barcodes are used to encode each element string. It also improves scanning accuracy, allowing for single scanning rather than multiple scanning. The various element strings are transmitted from the barcode reader as a single full string.

The various element strings, which are transmitted from concatenated barcodes, have to be analysed and processed. All element strings need to be separated by a separator character unless they have a predefined length or appear at the end of the symbol (encoded immediately before the symbol check character). All predefined length element strings are contained in [Figure 5.10.1-2](#).

The separator character SHALL be either the Function 1 Symbol Character (FNC1), or the control character <GS> (ASCII value 29 (decimal), 1D (hexadecimal)), or, in the case of GS1 QR Code symbology, the control character <GS> or the character '%' (ASCII value 37 (decimal), 25 (hexadecimal)). [Figure 5.10.1-2](#) contains all element strings that have a predefined length and, therefore, SHOULD not be terminated by a separator character.

Figure 5.10.1-2. Element strings with predefined length using GS1 Application Identifiers

First two digits of the GS1 Application Identifier	Number of characters (GS1 Application Identifier and data field)
00	20
01	16
02	16
(03)	16
(04)	18
11	8
12	8
13	8
(14)	8
15	8
16	8
17	8
(18)	8
(19)	8
20	4
31	10
32	10
33	10
34	10
35	10
36	10
41	16



Note: [Figure 5.10.1-2](#) is limited to the listed numbers and will remain unchanged. Those numbers in parentheses are not yet assigned. GS1 Application Identifiers starting with two digits that are not included in [Figure 5.10.1-2](#) have a variable length even if the definition of the GS1 Application Identifier specifies a fixed length data field.

5.10.2 Concatenation

5.10.2.1 Predefined length element strings

Concatenated element strings constructed from GS1 Application Identifiers with a predefined length SHOULD not use a separator character following the element string of predefined length. Each element string is immediately followed by either the next GS1 Application Identifier or the symbol check character and stop character.

For example, concatenation of net weight (4.00 kilograms) with the associated Global Trade Item Number (GTIN) 95012345678903 SHOULD not include the use of a separator character.

- (01) has a predefined element string length of 16 digits.
- (31nn) has a predefined element string length of 10 digits.

Figure 5.10.2.1-1. Data encoded in two GS1-128 symbols



Figure 5.10.2.1-2. Data encoded in one concatenated GS1-128 symbol



5.10.2.2 Non-predefined length element strings

An element string that does not start with two characters defined in figure 5.10.1-2 SHALL be terminated by a separator character, unless it is the last element string to be encoded, when a separator character SHOULD not be used. The separator character is placed immediately after a non-predefined length element string and is followed by the GS1 Application Identifier of the next element string. The separator character used is either the Function 1 Symbol Character (FNC1) or the control character <GS> (ASCII value 29 (decimal), 1D (hexadecimal)), and it is always represented in the transmitted message by the control character <GS> (ASCII value 29 (decimal), 1D (hexadecimal)). If the element string is the last to be encoded, it is followed by the Symbol Check and stop characters.

For example, concatenation of price per unit of measure (365 currency units) and batch number (123456) MUST use a separator character immediately after the price per unit of measure.

Figure 5.10.2.2-1. Data encoded in two GS1-128 symbols



Figure 5.10.2.2-2. Data encoded in one concatenated GS1-128 symbol



 **Note:** The FNC1 is not shown in human readable interpretation.

5.10.2.3 Other considerations when using concatenation

Concatenation is an effective means for presenting multiple element strings in a single barcode and is used to conserve label space and optimise scanning operations when permitted by the application standard.

When concatenating a mixture of predefined length and other element strings, the predefined element strings SHOULD appear together before the other element strings. This usually results in a shorter linear barcode.

The separator character appears in the decoded data string as control character <GS> (ASCII value 29, (decimal), 1D (hexadecimal)). A separator character SHOULD not be used at the end of the last element string encoded in a GS1 barcode.

Notwithstanding the above, the processing routine SHALL tolerate a single separator character immediately following any element string, whether necessary or not, and process the data in accordance with section 7.8 Processing of data from a GS1 symbology using GS1 Application Identifiers.

Figure 5.10.2.3-1. Example of GS1 DataBar Expanded Stacked barcode that uses concatenation



Concatenation may not be desirable in all circumstances (e.g., GS1 Logistics Labels are often constructed using multiple rows of barcode), in such cases the barcode containing the additional attribute data encoded using GS1 Application Identifiers SHOULD be printed in close proximity to the barcode containing the GS1 identification key.

Figure 5.10.2.3-2. Example of mixed GS1 symbologies
(GTIN encoded in UPC-E, Best before date in Composite)



5.10.3 GS1 Application Identifiers with implied decimal point positions

For all GS1 Application Identifiers with an implied decimal point position, the following rules apply:

For predefined length AIs

- For predefined length GS1 Application Identifiers with a data field length of 9 or less, the maximum number of decimal places is equal to the length of the AI data field as indicated in the format of the GS1 Application Identifier, minus 1. For example, for an AI with data format N8 the maximum number of decimal places is 7.
- For predefined length GS1 Application Identifiers with a length greater than 9, the maximum number of decimal places is 9. For example, for an AI with data format N12 the maximum number of decimal places is 9.

Example for predefined length AIs:

The data field format of AI (394n) is N4, so the maximum number of implied decimal places is 3.

Element string (3943)1020 specifies that the data field includes 3 decimal places, and therefore has an implied decimal point after the first digit: 1.020

For variable-length AIs

- For variable-length GS1 Application Identifiers with encoded data of 9 digits or less, the maximum number of decimal places is equal to the length of the encoded data, minus 1. For example, for a data field containing 4 digits the maximum number of decimal places is 3.
- For variable-length GS1 Application Identifiers with encoded data of more than 9 digits, the maximum number of decimal places is 9. For example, for a data field containing 11 digits the maximum number of decimal places is 9.

Example for variable-length AIs:

The data field format of AI (392n) is N..15, so the maximum number of implied decimal places is 9.

Element string (3929)300123456789 specifies a data field of 12 digits that includes 9 decimal places, and therefore has an implied decimal point after the third digit: 300.123456789.

Element string (3923)3000200 specifies a data field of 7 digits that includes 3 decimal places, and therefore has an implied decimal point after the fourth digit: 3000.200



Note: Consult the specific GS1 Application Identifier for additional restrictions that may apply to that GS1 Application Identifier.

6 Symbol placement guidelines

6.1	Introduction.....	347
6.2	General placement principles.....	347
6.3	General placement guidelines for point-of-sale.....	351
6.4	Placement guidelines for specific package types.....	356
6.5	Symbol placement for clothing and fashion accessories.....	384
6.6	GS1 Logistics Label design.....	397
6.7	Symbol placement used in general distribution.....	406
6.8	Symbol placement for regulated healthcare trade items.....	410

6.1 Introduction

This section includes guidelines for the placement of barcodes on packages and containers. It gives the general principles that apply, mandatory rules, and recommendations for symbol placement on specific packaging and container types.

Consistency of symbol placement is critical to successful scanning. With manual scanning, variation of symbol placement makes it difficult for the scanning operator to predict where the symbol is located, and this reduces efficiency. With automated scanning, the symbol must be positioned so that it will pass through the field of vision of a fixed scanner as it travels past. Respecting the guidance in this section will result in the consistency and predictability required.

The guidelines in this global specification replace previous local recommendations; however, manufacturers should not scrap packaging that has been printed according to previous guidelines. When packaging is redesigned, the global specifications in this document shall be observed. If government regulatory guidelines are inconsistent with those in this manual, the government guidelines should always take precedence.



Note: Barcodes in this guideline that are used as examples are “for position only” and are not intended to denote correct symbol type, size, colour, or quality.

6.2 General placement principles

The following general principles for barcode placement shall be considered for any package type, whether it is scanned at the point-of-sale or elsewhere in the supply chain. Trade items intended to be scanned at a point-of-sale must be marked with an EAN-13, UPC-A, EAN-8, UPC-E, GS1 DataBar Omnidirectional, GS1 DataBar Stacked Omnidirectional, GS1 DataBar Expanded or GS1 DataBar Expanded Stacked barcode. The barcodes that are scanned elsewhere are the EAN-13, UPC-A, ITF-14, GS1 DataBar and GS1-128 barcodes

EAN-8 and UPC-E barcodes are intended for use on very small trade items sold at the point-of-sale.

6.2.1 Number of symbols

Barcodes representing different Global Trade Item Numbers (GTINs) must never be visible on any one item. Although a minimum of one symbol is required, two symbols representing the same GTIN are recommended on trade items for scanning in warehousing or general distribution scanning environments (see section [6.7](#)). Two or more symbols representing the same GTIN are recommended on large, heavy, or bulky items for point-of-sale (see section [6.4.9](#)) and are permissible on random wraps intended for point-of-sale (see section [6.3.3.7](#)). Two symbols, EAN/UPC encoding GTIN and another encoding GTIN plus attributes may be required during migration periods to new data carriers (see section [4.15](#)).

6.2.2 Scanning environment

Before considering the package type, determine whether the item will be scanned in a point-of-sale or a general distribution scanning environment. If the item is scanned at a point-of-sale only, the barcode placement guidelines in sections [6.3](#), [6.4](#), and [6.5](#), and [6.5.5](#) apply. However, if the item is scanned in both a point-of-sale and general distribution scanning environment or in a general distribution scanning environment only, the requirements (see section [6.7](#)) take precedence.

6.2.3 Orientation

Barcode orientation is determined primarily by the print process and any curvature of the item. If the printing process and curvature allow, the preferred placement is picket fence orientation, in which the bars of the barcode are perpendicular to the surface on which the package stands in its normal display position. For human readable interpretation rules see section [4.14](#). Empirical data has demonstrated that it makes no difference to the scanning process one way or the other. Rules for positioning barcodes on curved surfaces are given in section [6.2.3.2](#).

Figure 6.2.3-1. Barcode orientation

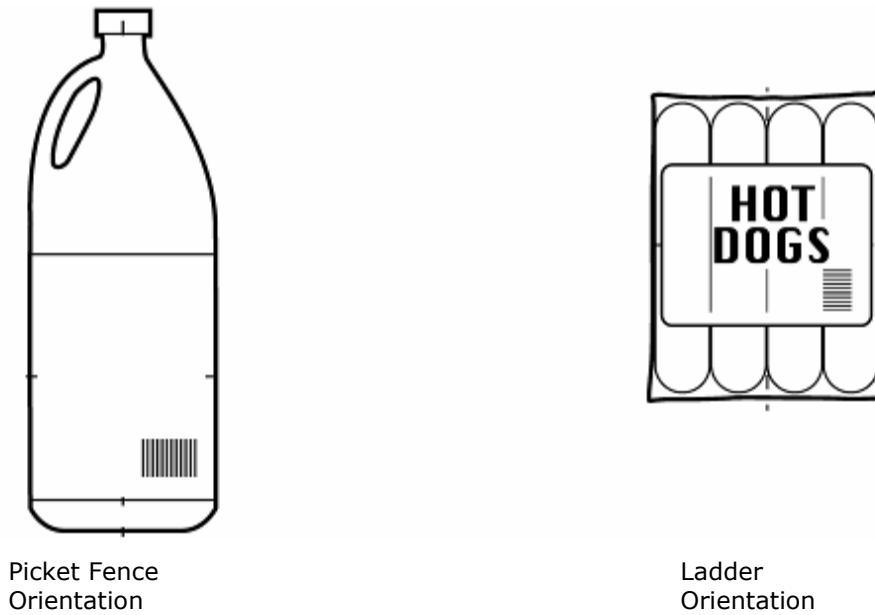

6.2.3.1 Printing direction

Barcode orientation is often determined by the printing process. Some printing processes give much higher quality results if the bars of the symbol run in the direction of the print, also known as the web direction. The printing company should always be consulted.

6.2.3.2 Trade items with curved surfaces

When a barcode is printed onto a curved surface it is sometimes possible for the extremes of the symbol to disappear around the curve, so that both ends cannot be visible to the scanner at the same time. This is more likely to occur the bigger the symbol and the tighter the curve of the packaging. In these situations, bars must be printed using certain combinations of the X-dimension and diameter of the curved surface (e.g., in ladder orientation on a can, in picket fence orientation on a cylindrical packet of biscuits). This helps ensure that the curve results in an apparent loss of height of the bars rather than the more serious apparent loss of complete bars.

Figure 6.2.3.2-1. Barcode placement on curved surfaces

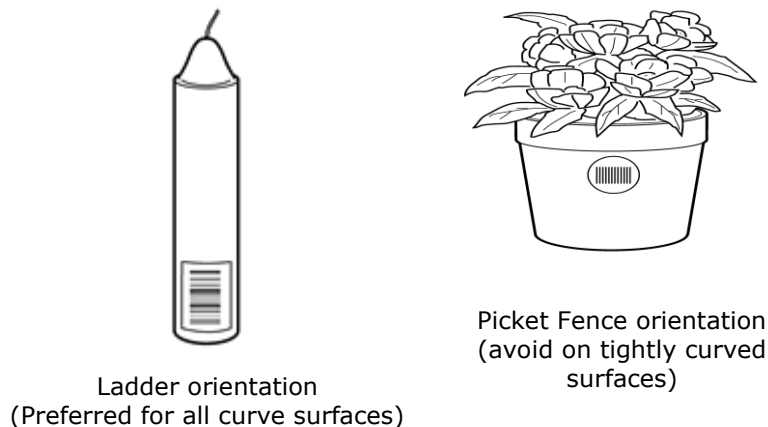

The angle between the tangent to the centre of the curved symbol and the tangent to the extremity of the curved symbol (outer edge of the guard bars for symbols in the EAN/UPC symbology) must be less than 30 degrees. If this angle is more than 30 degrees, the symbol must be oriented such that the bars are perpendicular to the generating lines of the surface of the item.

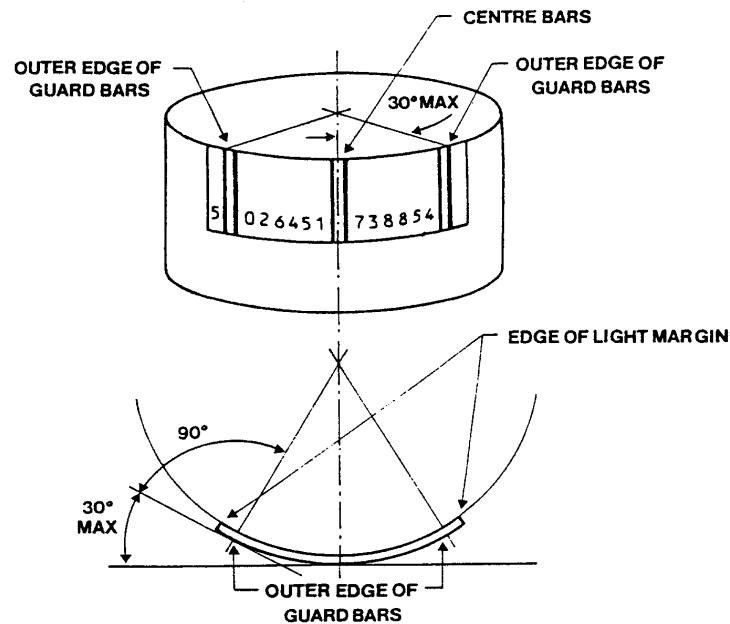
Figure 6.2.3.2-2. Relationship between symbol and curvature

Figures 6.2.3.2-3 and 6.2.3.2-4 show the relationship between acceptable X-dimensions (narrow element width) for units of different diameters and the minimum diameters for different X-dimensions for barcodes printed in the picket fence orientation. Please refer to section [5.5](#) for the minimum, target, and maximum X-dimension for the symbol, based on the scanning environment.

Figure 6.2.3.2-3. Relationship between diameter and the X-dimension

Diameter of container		Maximum Value of X-dimension			
		EAN-13 or UPC-A barcode		EAN-8 barcode	
mm	inches	mm	inches	mm	inches
30 or below	1.18 or below	*	*	*	*
35	1.38	*	*	(0.274)	(0.0108)
40	1.57	*	*	(0.314)	(0.0124)
45	1.77	*	*	0.353	0.0139
50	1.97	(0.274)	(0.0108)	0.389	0.0153
55	2.16	(0.304)	(0.0120)	0.429	0.0169
60	2.36	0.330	0.0130	0.469	0.0185
65	2.56	0.356	0.0140	0.508	0.0200
70	2.75	0.386	0.0152	0.549	0.0216
75	2.95	0.413	0.0163	0.587	0.0232
80	3.25	0.446	0.0174	0.627	0.0247
85	3.35	0.469	0.0185	0.660	0.0260
90	3.54	0.495	0.0195	0.660	0.0260
95	3.74	0.525	0.0207	0.660	0.0260
100	3.94	0.551	0.0217	0.660	0.0260
105	4.13	0.578	0.0228	N/A	N/A
110	4.33	0.607	0.0239	N/A	N/A
115	4.53	0.634	0.0250	N/A	N/A
120 or above	4.72	0.660	0.0260	N/A	N/A



Note: An asterisk (*) indicates that the package diameter is too small to permit a picket fence orientation barcode, and the symbol must be rotated 90 degrees to a ladder orientation (see section [5.5](#)) The barcode is printed perpendicular to the generating lines of the surface of the container.

✓ **Note:** *Italics* indicate X-dimensions that are permissible, but are not recommended on curved surfaces.

✓ **Note:** EAN-8 barcodes are reserved for very small items (See section [2.1](#)).

Figure 6.2.3.2-4. Relationship between the X-dimension and diameter

X-dimension		Minimum diameter of container					
		EAN-13 or UPC-A barcode		EAN-8 barcode		UPC-E barcode	
mm	inches	mm	inches	mm	inches	mm	inches
0.264	0.0104	48	1.89	34	1.33	26	1.01
0.300	0.0118	55	2.14	38	1.51	29	1.51
0.350	0.0138	64	2.50	45	1.76	34	1.53
0.400	0.0157	73	2.86	51	2.02	39	1.54
0.450	0.0177	82	3.21	58	2.27	44	1.73
0.500	0.0197	91	3.57	64	2.52	49	1.92
0.550	0.0217	100	3.93	70	2.77	54	2.11
0.600	0.0236	109	4.29	77	3.02	59	2.31
0.650	0.0256	118	4.64	83	3.27	63	2.50
0.660	0.0260	120	4.72	85	3.35	64	2.54

6.2.3.3 Avoiding scanning obstacles

Anything that will obscure or damage a barcode will reduce scanning performance and SHALL be avoided. For example:

- Never position the barcode on the item in an area with inadequate space. Do not let the other graphics encroach on the space for the barcode.
- Never place barcodes, including Quiet Zones, on perforations, die-cuts, seams, ridges, edges, tight curves, folds, flaps, overlaps, and rough textures.
- Never put staples through a barcode or its Quiet Zones.
- Never fold a symbol around a corner.
- Never place a symbol under a package flap.
- Barcodes used for production control purposes SHOULD be obstructed wherever possible before entering general distribution (see section [4.15](#).)

6.3 General placement guidelines for point-of-sale

This section outlines the guidelines for barcode placement on trade items that will be scanned at the point-of-sale. For detailed information on specific package types, see sections [6.4](#), [6.5](#), and [6.5.5](#). Section [6.7](#) outlines guidelines for barcode placement on trade items that will be scanned in warehousing or general distribution scanning environments.

6.3.1 Number of symbols

At least one barcode is needed on a trade item intended for the point-of-sale. Exceptions include large, heavy, or bulky items (see section [6.4.9](#)) and random or unregistered wrapping (see sections [6.3.3.7](#)) where two or more symbols with the same Global Trade Item Number (GTIN) may be required.

Trade items SHALL never have two or more barcodes encoding different Global Trade Item Numbers (GTINs). At the point-of-sale, this is particularly relevant with multipacks, such as over-wrapped items, sleeved items, and banded items, where the individual inner units carry a different GTIN from that on the outer wrapper or container. The barcodes on the inner products must be totally obscured so that they cannot be read by the point-of-sale system. (See section [6.3.3.7](#) for over-wrap special considerations.)

6.3.2 Identifying the back of the trade item

The front of the trade item is the primary trading/advertising area, which typically displays the product name and the company's logo. The back of the trade item is directly opposite the front and is the preferred placement area for the barcode on most trade items.

6.3.3 Symbol placement

Information in this section is provided to guide symbol placement when developing packaging for new products and should be adopted when changing the graphics of existing products.

6.3.3.1 Preferred placement

Preferred barcode placement is on the lower right quadrant of the back, respecting the proper Quiet Zone areas around the barcode and the edge rule (see the Edge Rule in section [6.3.3.3](#) and special considerations in section [6.3.3.7](#)).

6.3.3.2 Undesirable alternative

The undesirable alternative placement for a barcode is the lower right quadrant of a side of the container other than the back.

6.3.3.3 Edge rule

When possible, the barcode must not be closer than 8 mm (0.3 in.) or farther than 100 mm (4 inch) from the nearest edge of the package/container. Previous guidelines suggested a distance of 5 millimetres (0.2 inch) as a minimum. Practical experience has shown this to be inadequate. For example, cashiers often grab the edges of bags and other trade items with their thumbs. Avoid placing the barcode too close to the edge. Such placement reduces efficiency at the point-of-sale.

6.3.3.4 Avoid truncated symbols

Truncation of a barcode is the reduction of the height of a barcode relative to its length. Truncation is not recommended because it destroys the ability of a symbol to be scanned omnidirectionally at the point-of-sale. A truncated symbol can only be scanned when the trade item is oriented in particular directions across the scanning beam. Truncation, therefore, reduces checkout efficiency. The more the height of the symbol is reduced, the more critical becomes the alignment of the symbol across the scanning beam. Truncation SHALL be avoided unless absolutely necessary (e.g., when printing on a tightly curved surface), and then the maximum height possible SHALL be

printed. See section [6.2.3.2](#) for rules on the relationship between the diameter of the item and the X-dimension.

6.3.3.5 Bottom marking

Bottom marking of the trade item with the barcode continues to be acceptable, except for large, heavy, or bulky trade items. However, back (side) marking is preferred.

6.3.3.6 Exceptions to the general placement guidelines

Some trade items require special considerations for barcode placement.

- Bags

When bag contents settle, the bag edges can bulge to the extent that barcodes located on the lower right quadrant may not be flat enough to permit successful scanning. For this reason, barcodes on bags SHOULD be placed in the centre of the back about one third up from the bottom and as far from the edge as possible while respecting the edge rule. (See section [6.4.1](#) for more details on bags.)

- Blister packs or unpackaged items

Trade items that cause scanners to read beyond the flat plane include blister packs and unpackaged items (e.g., deep bowls). For these items, the distance between the scanner window and the barcode on the container or item must be considered. The barcode must not be closer than 8 millimetres (0.3 inch) or farther than 100 millimetres (4 inches) from any edge of the package/container. (See sections [6.4.2](#) and [6.4.16](#) for more details on blister packs and unpackaged items.)

- Large, heavy, or bulky items

Any package/container weighing more than 13 kilograms (28 pounds) or having two dimensions greater than 450 millimetres (18 inches) (width/height, width/depth, or height/depth) is considered a large, heavy, or bulky Item. Large, heavy, or bulky items tend to be hard to handle. 'Large, heavy, or bulky items may require two or more symbols with the same Global Trade Item Number (GTIN) ideally one on top and one on the bottom of the opposite quadrant' (See section [6.4.9](#) for more details on large, heavy, or bulky items.)

- Thin items or containers

Thin items or containers are packages/containers with a dimension less than 25 millimetres (1 inch) (height, width, or depth). Examples of thin items or containers are packages of pizza, powdered drink mixes, and writing pads. Any placement of the symbol on the edge hinders effective scanning because the symbol is obscured from the cashier and is likely to be truncated. (Refer to section [6.4.12](#) for more details on thin items or containers.)

6.3.3.7 Special packaging considerations for barcode placement

Some packaging methods require special considerations for barcode placement.

Over-wrap

Trade items sold in multiples are mechanically gathered and covered with clear over-wrap material that will carry print. Typical over-wrapped items are small cereal boxes and chocolate bars. Package over-wrap can create two distinct problems:

- Obscuring the barcodes on individual units inside the multipack is necessary so they are not confused with the outer multipack barcode, which must be different.
- Over-wrapping with such materials as cellophane causes diffraction or reflection of the light beam of the scanner and can reduce contrast, which causes scanning inefficiencies.

To determine proper barcode placement for over-wrapped packaging, follow the guidelines specific to the applicable package type/shape. (See section [6.4](#) for details on symbol placement for specific package types.)

Figure 6.3.3.7-1. Barcode placement on over-wrapped item

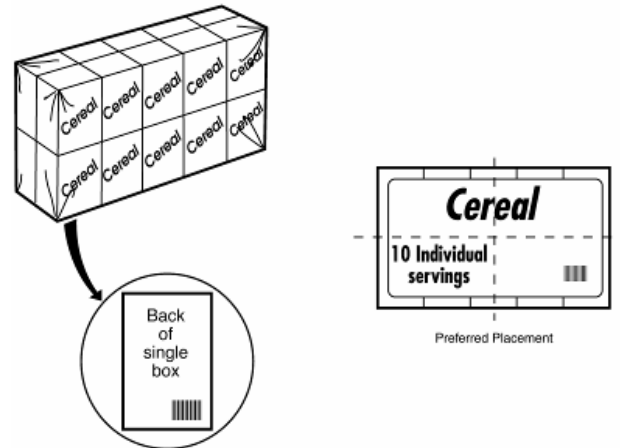

Random (unregistered) wrap

Some wrappers, like those used on sandpaper or margarine, have a repeating design and are neither cut nor placed on the product such that a particular part of the design always appears in the same location. This is referred to as random or unregistered wrapping. As the wrapper is not registered, it is unlikely that the symbol will appear on one face of the package when the wrapper is placed on the product.

The presence of more than one barcode on a package can have a detrimental effect on scanning productivity and, more importantly, can lead to a double read. For this reason, the use of registered packaging is preferred. If random wrap must be used, the minimum requirement is to print the symbol with sufficient frequency so that a full symbol will appear on one package face.

Double reads are more likely when the gaps between the symbols are larger. Repeating symbols SHOULD never be more than 150 millimetres (6 inches) apart.

Consideration should also be given to elongating the bars of the symbol to ensure a full symbol on one face, instead of repeating the symbol.

Figure 6.3.3.7-2. Barcode placement on random-wrapped item



Shrink film/vacuum-formed packages

The barcode on an item packaged in shrink film or that is vacuum-formed SHALL be located on a flat surface and in an area free of creases, wrinkles, or other types of distortions. Refer to figure 6.3.3.7-3, which shows barcode placement on hot dogs. Since the curvature of the hot dogs was

greater than the diameter shown within the section [6.2.3.2](#) figures, a ladder orientation symbol was used.

To determine proper barcode placement for shrink film/vacuum-formed packaging, follow the guidelines specific to the applicable package type/shape. (Refer to section [6.4](#) for details on symbol placement for specific package types/shapes.)

Figure 6.3.3.7-3. Barcode placement on shrink film/vacuum-formed item

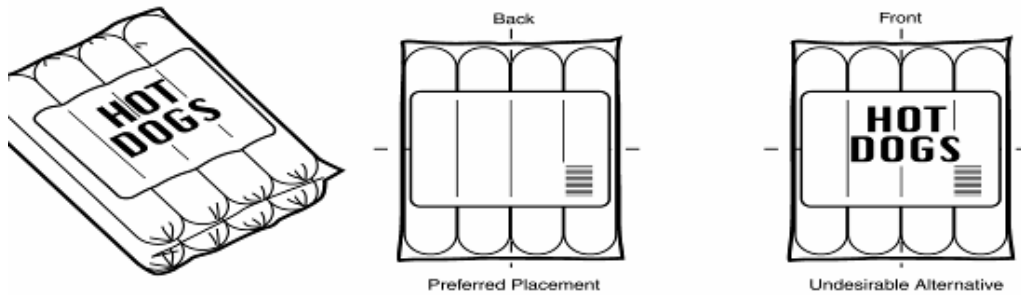

Spot labels

Barcodes printed on spot labels that are applied to the trade item are acceptable alternatives that incorporate symbols into existing packaging graphics or for use on items without packages, such as some pots, pans, tableware, and glassware. The most suitable type of spot label is one that cannot be removed from the item without destroying the symbol. Labels that are applied directly to the product should use an adhesive that is strong enough to adhere to the label for an extended shelf life, but which also allows the label to be removed without the use of solvents or abrasives.

To determine proper barcode placement on items bearing spot barcode labels, follow the guidelines specific to the applicable package type/shape. (Refer to section [6.4](#) for details on symbol placement for specific package types.)

Figure 6.3.3.7-4. Barcode placement with a spot label



Figure 6.3.3.7-5. Tableware items using barcode spot labels

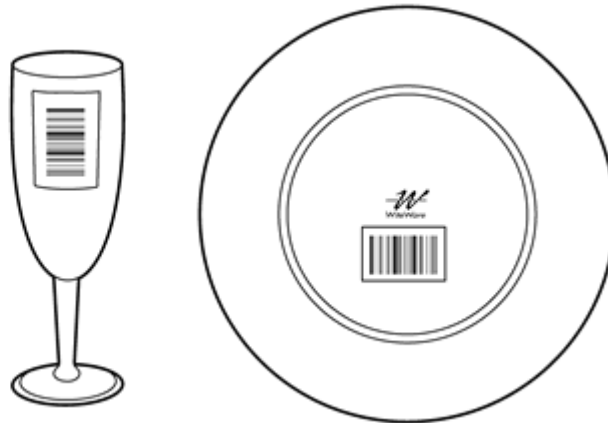

6.3.3.8 Operational considerations of barcode placement

Speed, efficiency, and effectiveness in scanning operations are the ultimate goals of proper barcode placement. To ensure that scanning performance will not be compromised, consider the following matters before deciding on final barcode placement:

- **Consistent symbol location:** Compare your package/container to packaging for like products to ensure equivalent symbol placement. The ease with which barcodes are located by a cashier from product to product essentially relies on consistent symbol placement.
- **Scan simulation (hand motion effectiveness):** Pass the barcode across the scanner with your hand to test the initial barcode placement. This test is intended to confirm that the barcode placement does not necessitate unnatural hand motions while you are scanning the symbol.

6.3.3.9 Security tag placement

When a visible security tag is used, the preferred placement is within a 75 millimetres (3 inches) diameter of the barcode placement. Consistent security tag placement makes it easier for the operator to predict security tag location and, thus, improves scanning efficiency.

6.4 Placement guidelines for specific package types

The following barcode placement guidelines apply to specific package types. Section [6.5](#) contains diagrams illustrating symbol placement for clothing and fashion accessories. Figure 6.4-1, Package Type Reference, describes the main packaging categories and products. This figure can be used to determine correct barcode placement by product or packaging. For example, according to the figure below, a package of flower seeds in a 50 millimetres (2 inches) by 75 millimetres (3 inches) envelope is classified as a thin item or container. The example given of this type of package is powdered soft drink mix. According to the first column of the Package Type Reference, the correct barcode placement for this package type is determined by looking at section [6.4.12](#).

Figure 6.4-1. Package type reference

Section	Package type	Package characteristics	Product examples
6.4.1	Bags	Sealed cylindrical or rounded-corner wrapped units	Potato chips, flour, sugar, bird seed
6.4.2	Blister packs	Flat card backing a formed clear plastic bubble placed over product	Toys, hardware parts
6.4.3	Bottles and jars	Small or large-mouth vessels sealed with removable lids	Barbecue sauce, fruit jelly
6.4.4	Boxes	Folded, sealed, heavy paper or corrugated cardboard cartons	Crackers, cereal, detergent
6.4.5	Cans and cylinders	Cylindrical-shaped units sealed at each end	Soups, drinks, cheese, biscuits
6.4.6	Carded items	Items mounted or sealed on flat cards	Hammers, parcels of candy, kitchen utensils
6.4.7	Egg cartons	Irregular hexahedrons of plastic or moulded pulp with hinged lids	Eggs
6.4.8	Jugs	Glass or plastic vessel with built-in handle(s) and removable lid(s)	Household cleaners, cooking oil
6.4.9	Large, heavy, bulky items	Items having physical dimension of 450 mm (18 in.) or more in any two dimensions and/or weight in excess of 13 kg (28 lbs.)	Pet food, unassembled furniture, sledge hammers
6.4.10	Multipacks	Multiple items mechanically bound to create one package	Soft drink cans
6.4.11	Publishing items	Printed paper media that is bound, stapled, or folded	Books, magazines, newspapers, tabloids
6.4.12	Thin items or containers	Items or containers with one dimension less than 25 mm (1 in.)	Boxes of pizza, CD jewel boxes, powdered soft drink mix packages, writing pads
6.4.13	Trays	Flat, formed receptacles holding product covered with over-wrap	Prepared meats, pastries, snacks, pies, pie crusts
6.4.14	Tubes	Firmly packed cylinders sealed at both ends, or sealed at one end with a cap or valve on the other end	Toothpaste, sausage, caulk
6.4.15	Tubs	Deep vessels with removable lids	Margarine, butter, ice cream, whipped cream
6.4.16	Unpackaged	Trade items that have no packaging, are often of an unusual shape, and are hard to label and scan	Frying pans, mixing bowls, cooking pots, giftware
6.4.17	Sets	Trade items that can be sold individually or as part of a boxed set.	Table and giftware
6.4.18	Sporting goods	Unpackaged items of specific size and shape.	Racquets, skis, skateboards

6.4.1 Bags

Although this category is referred to as “bags,” these packages/containers are often called sacks or pouches. This category includes paper or plastic containers that are:

- Fold-sealed on both ends (e.g., flour, sugar).
 - Fold-sealed on one end and pinched sealed at the other end (e.g., potato chips).
 - Pinch-sealed at both ends (e.g., cough drops).
 - Fold-sealed on one end and gathered at the other end (e.g., bread).
-  **Note:** Some bags are sealed at both ends and carded for display, such as bags of sweets. These types of items are not considered bags but fall into the carded items category. (See section [6.4.6](#) for details on carded items.)
- Package characteristics: Sealed cylindrical or rounded-corner wrapped units
 - Unique considerations: Bags have a tendency to have contents that shift and bulge. Consequently, barcode placement must be on an area of the bag that is most likely to remain flat.
 - Barcode placement: Identify the front of the package/container. (See section [6.3.2](#) for instructions on how to identify the package front):
 - Preferred placement: On the lower right quadrant of the back and away from the edge, respecting the proper Quiet Zone areas around the barcode.
 - Undesirable alternative: On the lower right quadrant of the front, and away from the edge, respecting the proper Quiet Zone areas around the barcode.
 - Edge rule: See section [6.3.3.3](#).

Figure 6.4.1-1. Symbol placement on bags



6.4.2 Blister packs

Blister packs are pre-formed clear plastic bubbles, or blisters, containing a product and backed or topped with card stock.

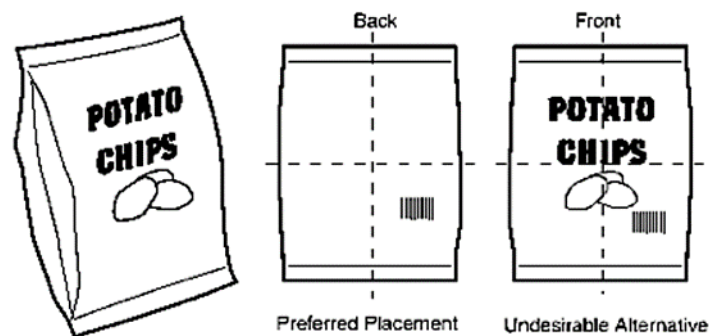
- Package characteristics: flat card, backing a formed clear plastic bubble placed over the product.
- Unique considerations: to ensure quality scanning, the barcode must be clear of the blister edges. Avoid placing the symbol under the blister pack or placing the symbol over any perforations on the back of the package.
- Barcode placement: identify the front of the package/container. (Refer to section [6.3.2](#), Identifying the back of the trade item, for instructions on how to identify the package front):
 - Preferred placement: on the lower right quadrant of the back, near the edge, respecting the proper Quiet Zone areas around the barcode.
 - Undesirable alternative: on the lower right quadrant of the front, near the edge, respecting the proper Quiet Zone areas around the barcode.
 - Edge rule: See section [6.3.3.3](#).

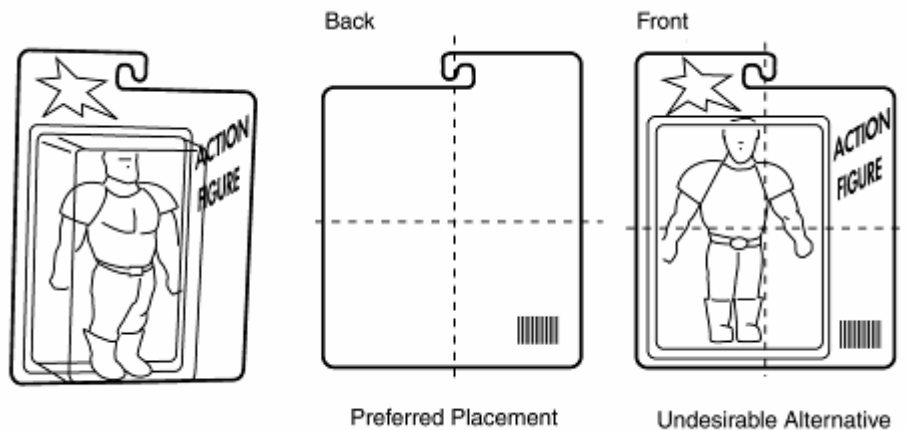
Figure 6.4.2-1. Symbol placement on blister packs

6.4.3 Bottles and jars

Bottles and jars normally carry spot labels applied to confined areas of the package, not covering the entire surface or wrapping around the entire perimeter.

- Package characteristics: Small or large-mouth containers sealed with removable lids.
- Unique considerations: Application of the barcode to the neck of a bottle is not allowed. Symbol placement on the neck of the bottle necessitates additional handling at the point-of-sale, and space limitations on this area of the bottle usually result in symbol truncation.

When a barcode is printed onto a curved surface it is sometimes possible for the extremes of the symbol to disappear around the curve. See section [6.2.3.2](#) for rules on the relationship between the diameter of the item and the X-dimension.

- Barcode placement: Identify the front of the package/container. (Refer to section [6.3.2](#), Identifying the back of the trade item, for instructions on how to identify the package front):
 - Preferred placement: On the lower right quadrant of the back, near the edge, respecting the proper Quiet Zone areas around the barcode.
 - Undesirable alternative: On the lower right quadrant of the front, near the edge, respecting the proper Quiet Zone areas around the barcode.
 - Edge rule: See section [6.3.3.3](#).

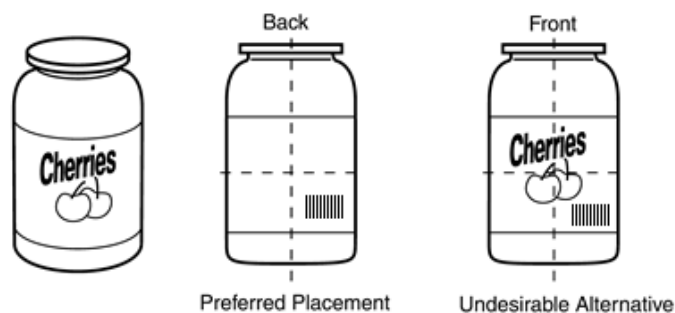
Figure 6.4.3-1. Symbol placement on bottles and jars

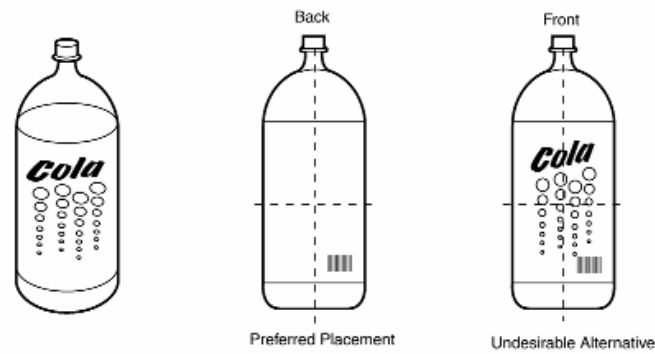

6.4.4 Boxes

This package type includes cuboid or cylindrical card or plastic cartons, as well as rectangular sleeves (used for products such as light bulbs). These packages might contain anything from crackers or cereal to detergent.

- Package characteristics: Folded, sealed, heavy paper or corrugated cardboard cartons.
- Unique considerations: There are no unique considerations that apply to this package type.
- Barcode placement: Identify the front of the package/container. (Refer to section [6.3.2](#), Identifying the back of the trade item, for instructions on how to identify the package front):
 - Preferred placement: On the lower right quadrant of the back, near the edge, respecting the proper Quiet Zone areas around the barcode.
 - Undesirable alternative: On the lower right quadrant of the front, near the edge, respecting the proper Quiet Zone areas around the barcode.
 - Edge rule: See section [6.3.3.3](#).

Figure 6.4.4-1. Symbol placement on boxes

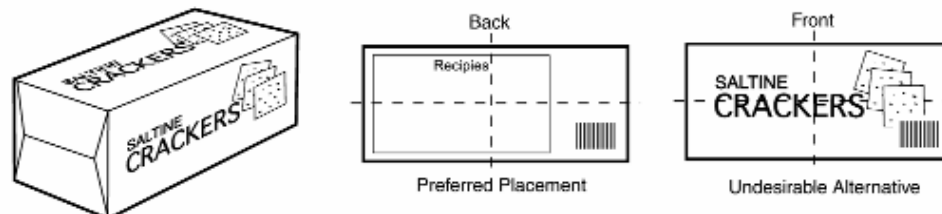

6.4.5 Cans and cylinders

This category includes cylindrical shaped containers (usually made of plastic or metal) that are sealed at each end. Some containers have removable lids or openings. Common examples are canned fruit and vegetables, paints, and adhesives.

- Package characteristics: Cylindrical-shaped units sealed at each end.
- Unique considerations: Obstacles, such as beading, seams, and/or ridges on the package/container SHALL be avoided, because they will reduce scanning performance. When a barcode is printed onto a curved surface it is sometimes possible for the extremes of the symbol to disappear around the curve. See section [6.2.3.2](#) for rules on the relationship between the diameter of the item and the X-dimension.
- Barcode placement: Identify the front of the package/container. (Refer to section [6.3.2](#), Identifying the back of the trade item, for instructions on how to identify the package front):
 - Preferred placement: On the lower right quadrant of the back, near the edge, respecting the proper Quiet Zone areas around the barcode.

- Undesirable alternative: On the lower right quadrant of the front, near the edge, respecting the proper Quiet Zone areas around the barcode.
- Edge rule: See section [6.3.3.3](#).

Figure 6.4.5-1. Placement on cans and cylinders

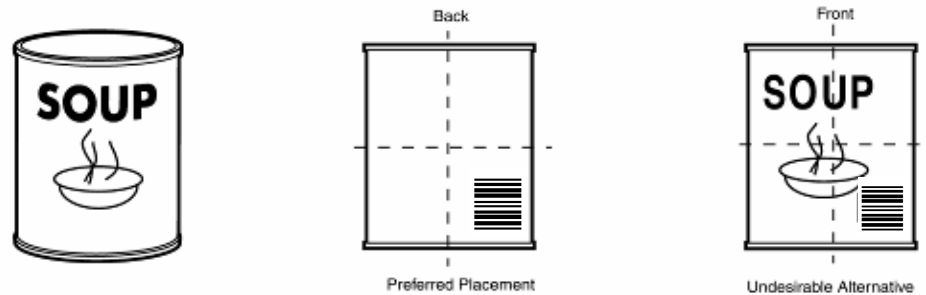

6.4.6 Carded items

Small, loose, or non-packaged items that are difficult to label are placed on cards that are marked with a barcode. Examples include hammers, toys, and kitchen utensils.

- Package characteristics: Items mounted or sealed on flat cards.
- Unique considerations: When placing barcodes on carded items, it is important to take into consideration the proximity of the barcode to the product. Be sure to allow adequate space for the symbol, avoiding any obstructions that might be caused by placing the symbol too close to the product. In addition, do not place the symbol over any perforations or other obstructions on the package.
- Barcode placement: Identify the front of the package/container. (Refer to section [6.3.2](#), Identifying the back of the trade item, for instructions on how to identify the package front):
 - Preferred placement: On the lower right quadrant of the back, near the edge, respecting the proper Quiet Zone areas around the barcode.
 - Undesirable alternative: On the lower right quadrant of the front, near the edge, respecting the proper Quiet Zone areas around the barcode.
 - Edge rule: See section [6.3.3.3](#).

Figure 6.4.6-1. Symbol placement on carded items

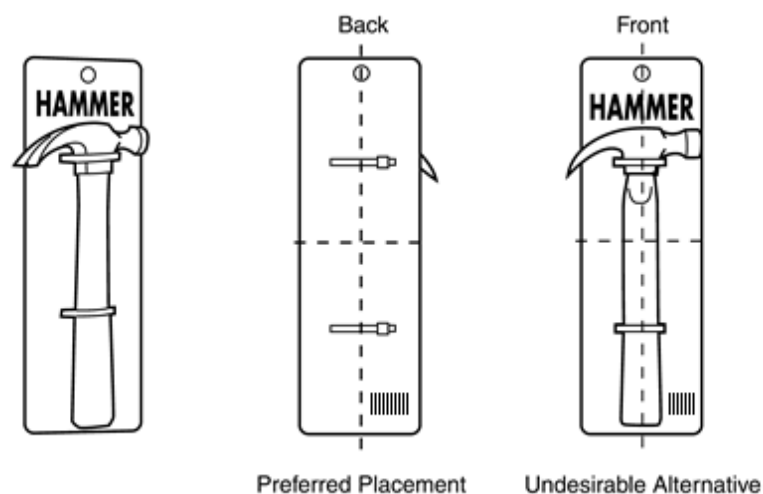

6.4.7 Egg cartons

Moulded pulp, foam, or plastic egg cartons come in sizes according to the number of eggs contained.

- Package characteristics: Irregular shaped hexahedrons of plastic or moulded pulp with a hinged lid.
- Unique considerations: The recommended symbol placement is on the side of the lid portion of the egg carton that opens and closes to cover the eggs. The uneven surface of the moulded bottom of an egg carton prevents barcode placement in this area.
- Barcode placement: To determine barcode placement on an egg carton, first identify the top of the carton by locating the primary trading/advertising area, which is marked with the product name and the company's logo. The bottom of the egg carton is the moulded area directly opposite the top in which the eggs sit. The sides are divided horizontally by a hinged lid. The front of the carton is the long side containing the opening/closing mechanism. The back of the carton is directly opposite the front, on the long side with the hinge:
 - Preferred placement: Near the edge, on the right half of the back, above the hinge on the lid, respecting the proper Quiet Zone areas around the barcode.
 - Undesirable alternative: On the lower right quadrant of the top, on the lid adjacent to the opening/closing mechanism, near the edge, respecting the proper Quiet Zone areas around the barcode.
 - Edge rule: See section [6.3.3.3](#).

Figure 6.4.7-1. Symbol placement on egg cartons

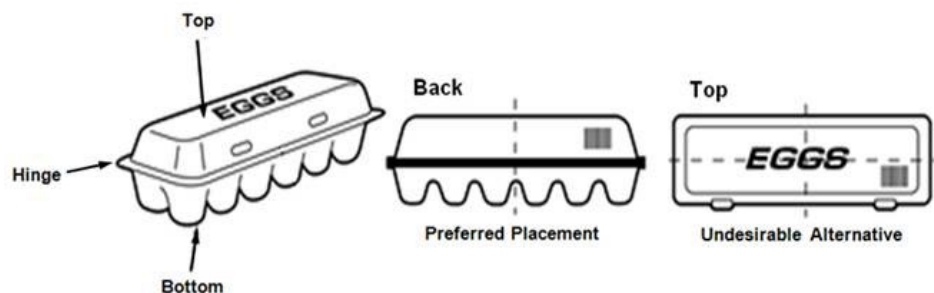

6.4.8 Jugs

Jugs are glass or plastic containers with a built-in handle(s) that aids in pouring of contents. Jugs normally carry spot labels applied to defined areas of the package, not covering the entire surface of the trade item or wrapping around the entire perimeter of the item.

- Package characteristics: Glass or plastic vessels with built-in handles and removable lids.
- Unique considerations: Application of the symbol to the neck of the jug is not allowed. Placement of the symbol on the neck of the jug necessitates additional handling at the point-of-sale, and space limitations on the neck usually result in symbol truncation.

When a barcode is printed onto a curved surface it is sometimes possible for the extremes of the symbol to disappear around the curve. See section [6.2.3.2](#) for the rules on the relationship between the diameter of the item and the X-dimension.

- Barcode placement: Identify the front of the package/container. (Refer to section [6.3.2](#), Identifying the back of the trade item, for instructions on how to identify the package front):
 - Preferred placement: On the lower right quadrant of the back, near the edge, respecting the proper Quiet Zone areas around the barcode.
 - Undesirable alternative: On the lower right quadrant of the front, near the edge, respecting the proper Quiet Zone areas around the barcode.
 - Edge rule: See section [6.3.3.3](#).

Figure 6.4.8-1. Symbol placement on jugs

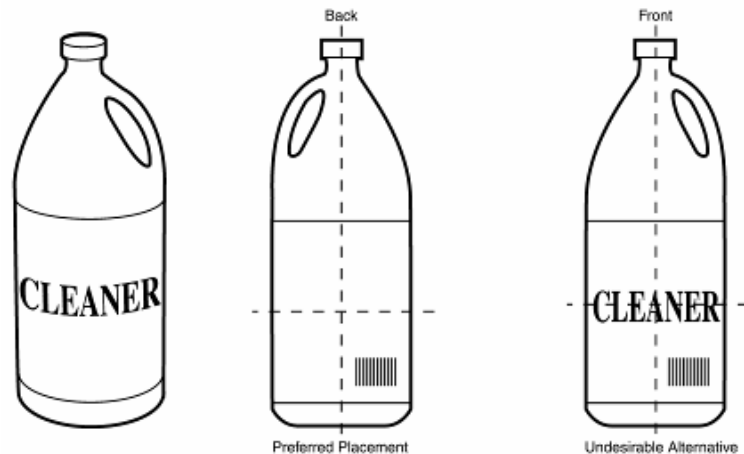

6.4.9 Large, heavy, or bulky items

- Package characteristics: Items considered large, heavy, or bulky have a physical dimension of 450 millimetres (18 inches) or more in any two dimensions (width/height, width/depth, or height/depth), and/or weigh in excess of 13 kilograms (28 pounds).
- Unique considerations:
 - Number of symbols: Large, heavy, or bulky items may require two or more symbols with the same Global Trade Item Number (GTIN) ideally one on top and one on the bottom of the opposite quadrant.
 - Special labels: A special double label with a tear-out barcode may be applied to large, heavy, or bulky items that are too heavy or awkward to pick up and pass over a fixed scanner. This label has one section that is permanently adhered to the item's box (or to a hang-tag or card if the item is not boxed). This section has a non-HRI text (number and item description) printed above a full-size barcode. Beneath a perforation, a second section contains exactly the same non-HRI text and an identical full-size barcode. The two sections are virtually identical except that the section below the perforation has no adhesive on its back.

Figure 6.4.9-1.

SAMPLE ILLUSTRATION OF THE DOUBLE LABEL WITH TEAR-OUT UPC

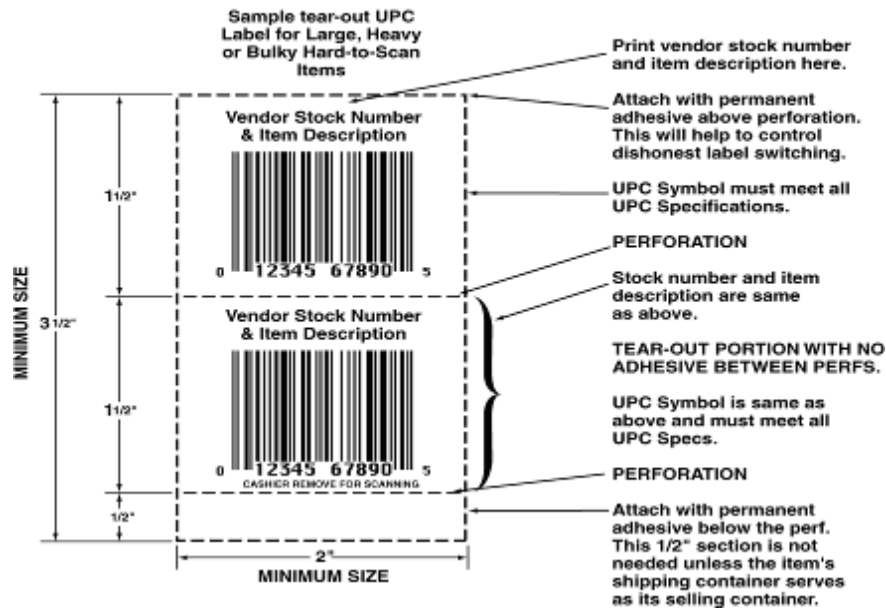

- When the item is brought to the point-of-sale, the lower half of the label below the perforation is removed. The cashier then either scans the label or, if the symbol cannot be scanned, the cashier key-enters the human readable interpretation beneath the symbol. The top label remains attached to the item or its box.

In instances where the large, heavy, or bulky item is displayed and sold in its shipping container, a third section of label is recommended. Beneath the tear-out label, a second perforation and a 12 millimetres (0.50 inch) section with permanent adhesive SHALL be added. This provides a more secure vehicle for the tear-out section and makes it less likely to tear off in transit.

- Human readable interpretation: Human readable interpretation on large, heavy, or bulky items SHOULD be a minimum of 16 millimetres (5/8 inch) high. This facilitates easier capture of the number by the cashier without having to pick up the product and move it across the scanner.
- Barcode placement: Identify the front of the package/container (See section 6.3.2, Identifying the back of the trade item, for instructions on how to identify the package front).
- Preferred placement:
 - Bags: Two barcodes are required, one on the front of the bag, at the top of the upper right quadrant, near the edge, and the other on the back of the bag, centred in the lower right quadrant, near the edge (to accommodate settling of contents).

Figure 6.4.9-2. Symbol placement on large, heavy, or bulky bags

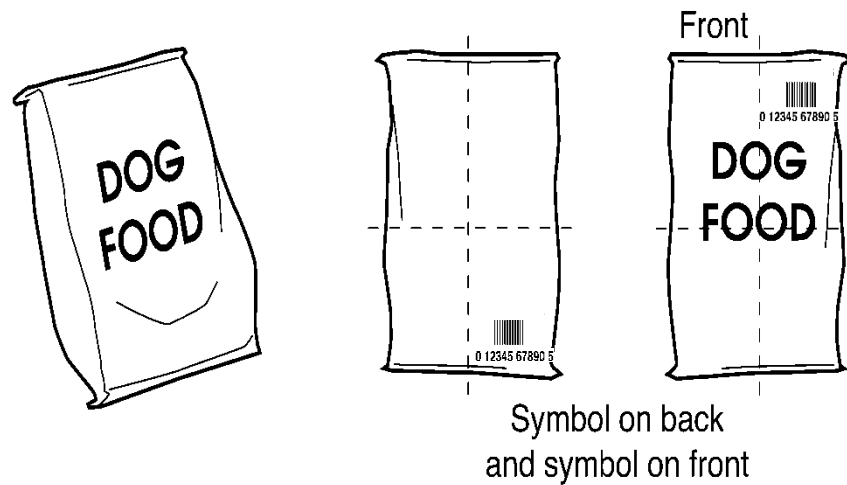
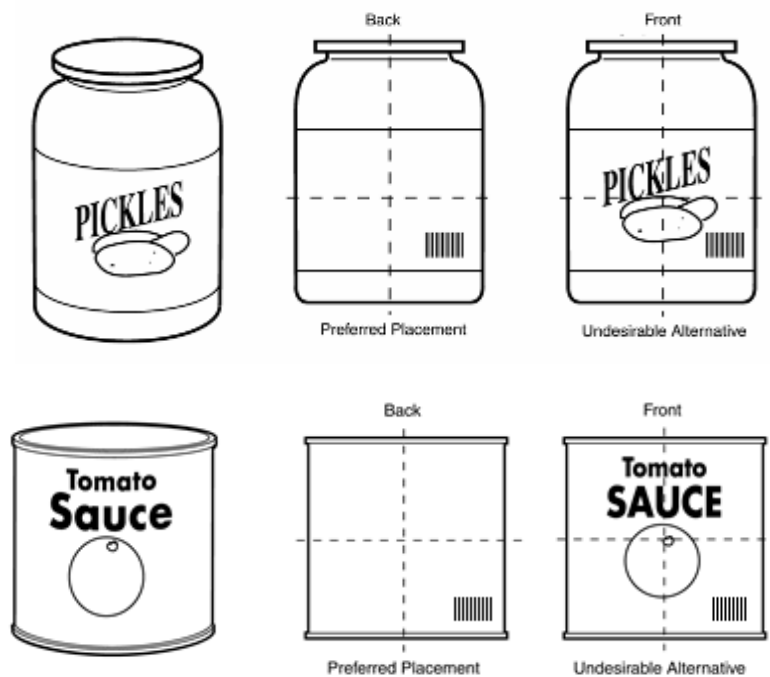

Figure 6.4.9-3. Symbol placement on large, heavy, or bulky jars, cans, jugs, or tubs



- Undesirable alternative: On the lower right quadrant of the front, near the edge, respecting the proper Quiet Zone areas around the barcode.
- Edge rule: See section [6.3.3.3](#).

6.4.10 Multipacks

Multipacks are single items that are packaged together as one unit or trade item. Multipacks provide convenience to the consumer and/or may represent a price reduction compared to purchasing items individually. Typical multipacks contain bottles, cans, jars, and tubs.

- Package characteristics: multiple single items bound together to create one package.
- Unique considerations: as a general rule, a barcode **MUST** be placed on every consumer package traded through the supply chain. Consequently, items sold in multipacks as well as those sold

individually must carry a unique barcode for each consumer package variation or aggregation. To avoid confusion at the point-of-sale, the multipack barcode SHALL be the only visible symbol when both the multipack and individual items are symbol-marked. The binder of the multipack acts as a screen to obscure the symbols on the individual items.

- Special note for can multipacks: Avoid placing the symbol on the top or bottom of the container, since cans have a tendency to cause impressions in the corrugated cardboard and distort the symbol. These can impressions in the symbol may reduce scannability.
- Barcode placement: identify the front of the package/container. (Refer to section [6.3.2](#), Identifying the back of the trade item, for instructions on how to identify the package front):
 - Preferred placement: on the lower right quadrant of the back, near the edge, respecting the proper Quiet Zone areas around the barcode.
 - Undesirable alternative: on the lower right quadrant of another side, near the edge, respecting the proper Quiet Zone areas around the barcode.
 - Edge rule: See section [6.3.3.3](#).

Figure 6.4.10-1. Symbol placement on multipacks

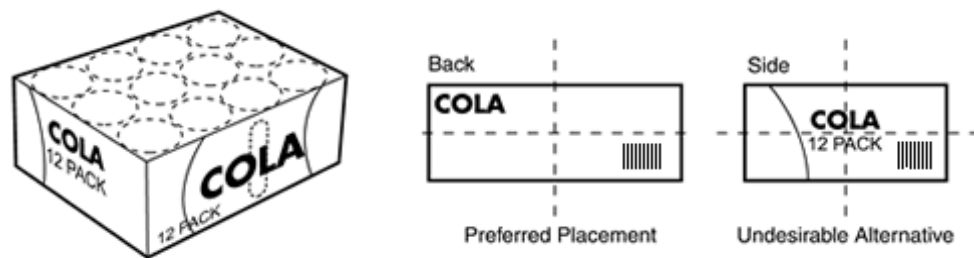

6.4.11 Publishing items

Publishing items represent printed materials sold individually for consumer use including books, magazines, newspapers, and tabloids. Barcode placement on published items varies depending on type. In addition, the main barcodes on books and paperbacks must appear on the outside cover of the book (to facilitate payment).

- Package characteristics: printed paper media that is bound, stapled, or folded.
- Unique considerations: in addition to the regular barcode, some publishing items have add-on symbols that carry supplementary information such as an Issue Code. Barcode placement on published items varies depending on the media type. If an add-on symbol is used, it must be located to the right of the regular barcode and parallel to it.
- Barcode placement: identify the front of the package/container. (Refer to section [6.3.2](#), Identifying the back of the trade item, for instructions on how to identify the package front):
 - Preferred placement:
 - Books: on the lower right quadrant of the back, near the spine, respecting the proper Quiet Zone areas around the barcode.

Figure 6.4.11-1. Symbol placement on books

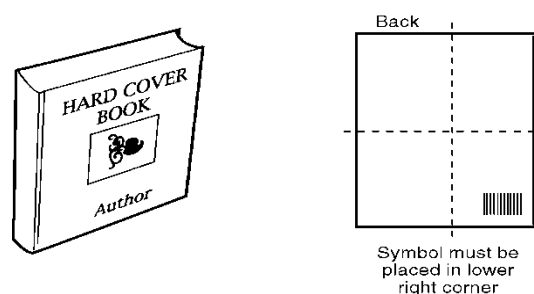

- Magazines: On the lower left quadrant of the front, near the edge, respecting the proper Quiet Zone areas around the barcode.

Figure 6.4.11-2. Symbol placement on magazines

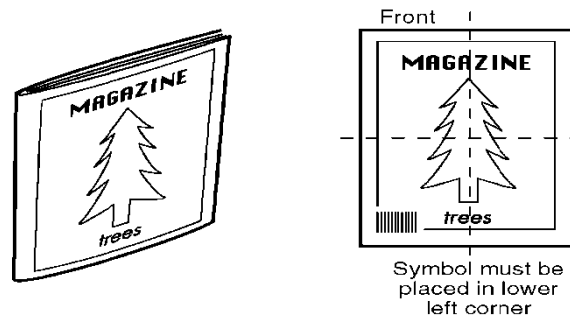

- Newspapers: when displayed for sale as shown on the left in figure 6.4.11-3, place the symbol on the lower left quadrant of the front, near the edge, respecting the proper Quiet Zone areas around the barcode. If an add-on symbol is used, it must be located to the right of the regular barcode and parallel to it.

Figure 6.4.11-3. Symbol placement on newspapers

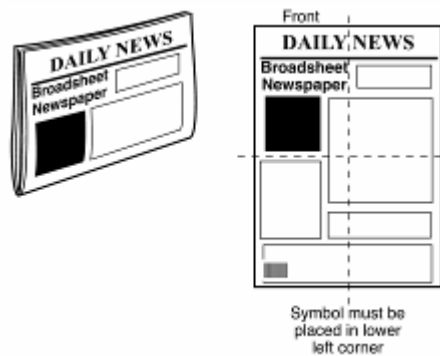

When displayed for sale as shown in figure 6.4.11-4, place the symbol on the lower right quadrant of the back, near the edge, respecting the proper Quiet Zone areas around the barcode. If an add-on symbol is used, it must be located to the right of the regular barcode and parallel to it.

Figure 6.4.11-4. Symbol placement on newspapers

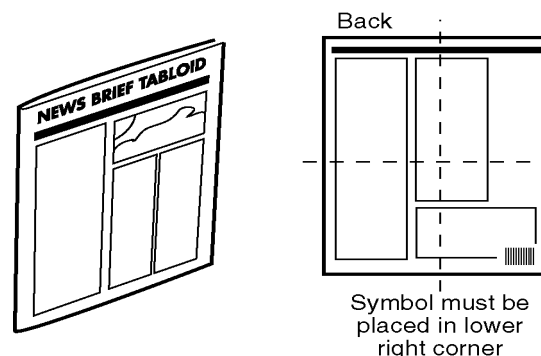

- Undesirable alternative: The undesirable alternative is not feasible for this package type.
- Edge rule: See section [6.3.3.3](#).

6.4.12 Thin items or containers

This package type is so named because items and containers in this category have one physical dimension less than 25 millimetres (1 inch). Items such as these, particularly those without a

significant bottom surface, SHOULD be marked on the lower right quadrant of the back side. Boxes of pizza, compact disk boxes, packages of powdered drink mix, and writing pads are examples.

- Package characteristics: items or containers with one dimension less than 25 millimetres (1 inch).
- Unique considerations: there are no unique considerations that apply to this package type.
- Barcode placement: identify the front of the package/container. (Refer to section [6.3.2](#), Identifying the back of the trade item, for instructions on how to identify the package front):
 - Preferred placement: on the lower right quadrant of the back, near the edge, respecting the proper Quiet Zone areas around the barcode.
 - Undesirable alternative: on the lower right quadrant of the front, near the edge, respecting the proper Quiet Zone areas around the barcode.
 - Edge rule: See section [6.3.3.3](#).

Figure 6.4.12-1. Symbol placement on thin items or containers

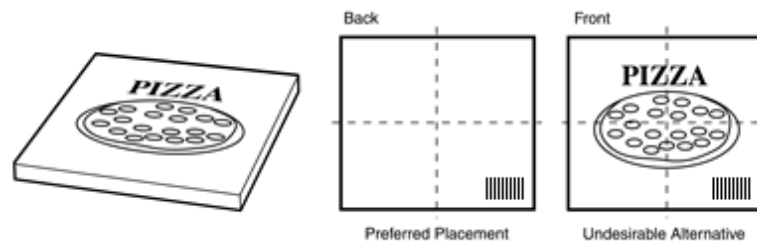
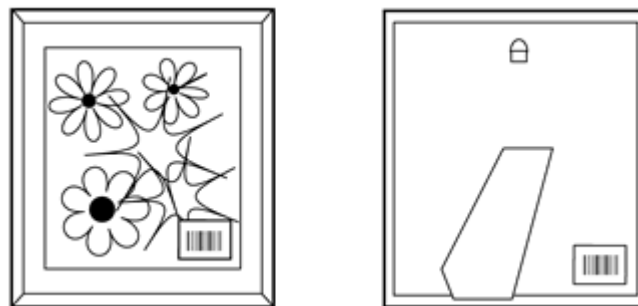

Figure 6.4.12-2. Unpackaged item without room for bottom marking



6.4.13 Trays

This package type includes thin square, rectangular, or circular trays holding items that are covered with over-wrap of clear shrink-film or that are vacuum-sealed. Examples include meats, pastries, snacks, and pies or piecrusts.

- Package characteristics: Flat, formed receptacles holding product covered with over-wrap.
- Unique considerations: When placing barcodes on trays, it is important to ensure that the barcode is placed on a flat surface. In addition, do not place the symbol over any perforations or other obstructions on the package.
- Barcode placement: Identify the front of the package/container. (Refer to section [6.3.2](#), Identifying the back of the trade item, for instructions on how to identify the package front):
 - Preferred placement: On the lower right corner of the top, near the edge, respecting the proper Quiet Zone areas around the barcode.
 - Edge rule: See section [6.3.3.3](#).

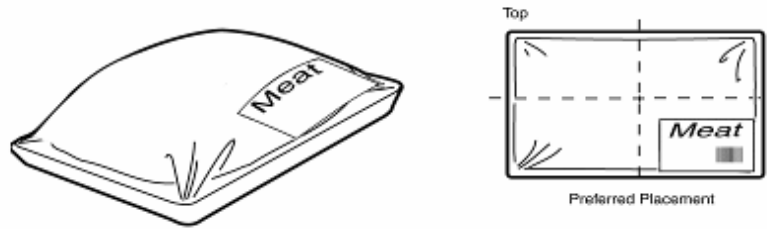
Figure 6.4.13-1. Symbol placement on trays

6.4.14 Tubes

Tubes are cylindrical shaped items or containers that are either sealed at both ends, such as sausage or refrigerated dough, or that are sealed at one end and have a cap or valve on the other end, such as toothpaste or caulk.

- Package characteristics: Firmly packed cylinders sealed at both ends, or sealed at one end with a cap or valve on the other end.
- Unique considerations: When a barcode is printed onto a curved surface it is sometimes possible for the extremes of the symbol to disappear around the curve. See section [6.2.3.2](#) for the rules on the relationship between the diameter of the item and the X-dimension.
- Barcode placement: Identify the front of the package/container. (Refer to section [6.3.2](#), Identifying the back of the trade item, for instructions on how to identify the package front):
 - Preferred placement: On the lower right quadrant of the back, near the edge, respecting the proper Quiet Zone areas around the barcode.
 - Undesirable alternative: On the lower right quadrant of the front, near the edge, respecting the proper Quiet Zone areas around the barcode.
 - Edge rule: See section [6.3.3.3](#).

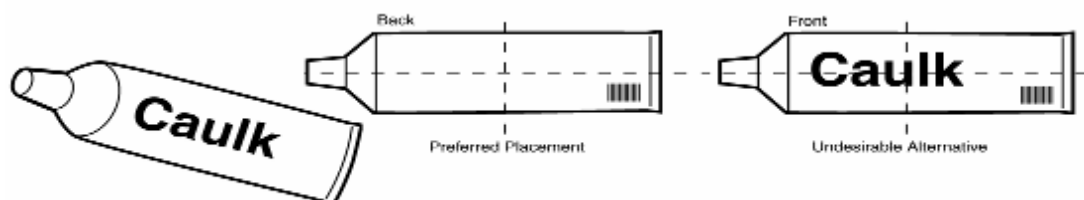
Figure 6.4.14-1. Symbol placement on tubes

6.4.15 Tubs

Tubs are circular containers (usually made of paper, plastic, or metal) that have removable lids. In most cases, they have spot labels that do not cover the entire surface of the container. Examples include margarine, butter, ice cream, and whipped topping.

- Package characteristics: Deep vessels with removable lids.
- Unique considerations: When a barcode is printed onto a curved surface it is sometimes possible for the extremes of the symbol to disappear around the curve. See section [6.2.3.2](#) for the rules on the relationship between the diameter of the item and the X-dimension.
- Barcode placement: Identify the front of the package/container. (See section [6.3.2](#), Identifying the back of the trade item, for instructions on how to identify the package front):
 - Preferred placement: On the lower right quadrant of the back, near the edge, respecting the proper Quiet Zone areas around the barcode.

- Undesirable alternative: On the lower right quadrant of the front, near the edge, respecting the proper Quiet Zone areas around the barcode.
- Edge rule: See section [6.3.3.3](#).

Figure 6.4.15-1. Symbol placement on tubs

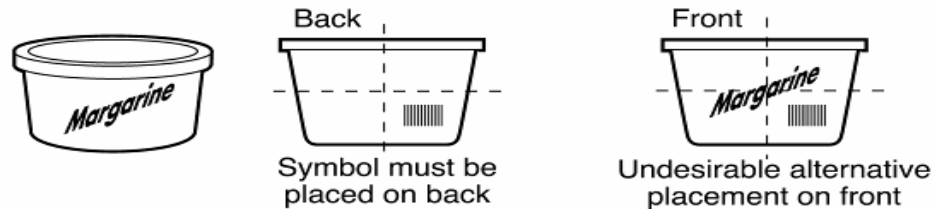

6.4.16 Unpackaged items

These are square, rectangular, circular, concave, or convex shaped items, including bowls, pots, pans, skillets, cups, vases, and other products (with or without contents), that lack an upright surface suitable for symbol placement.

- Package characteristics: These are items that are unpackaged and sold with spot labels, hangtags or carded sleeves.
- Unique considerations: When selecting symbol placement, consider the product's concave shape on the inside or irregular curvature on the outside while respecting the scanning distances defined in the edge rule below.
- The general marking guideline for table and giftware items is to use a hangtag. This avoids any damage to the item that could be caused by the spot label adhesive. If this is not practical, the spot label SHALL be applied to the bottom of the item and below the backstamp (where present).
- Barcode placement: Barcode placement on unpackaged items depends on the shape and type of the item. The following examples illustrate symbol placements appropriate to specific item types.
 - Preferred placement: The figures that follow indicate acceptable placement locations for other shaped items.
 - Undesirable alternative: The undesirable alternative is not applicable.
 - Edge rule: See section [6.3.3.3](#).

Figure 6.4.16-1. Example barcode location on unpackaged item

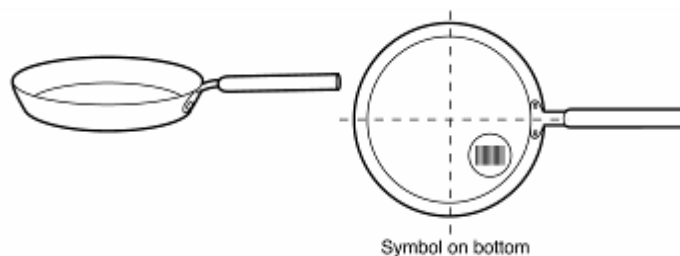

Figure 6.4.16-2. Example barcode location on unpackaged item

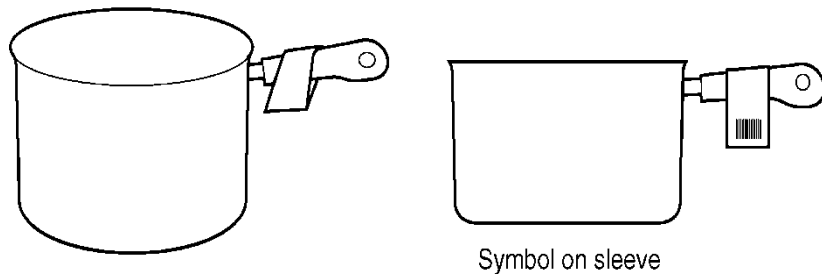

Figure 6.4.16-3. Example barcode location on unpackaged item

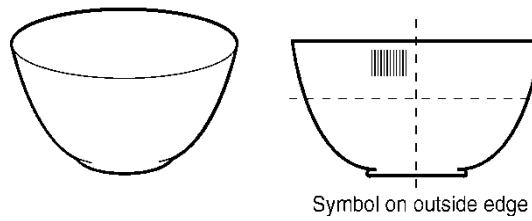

Figure 6.4.16-4. Example barcode location on unpackaged item

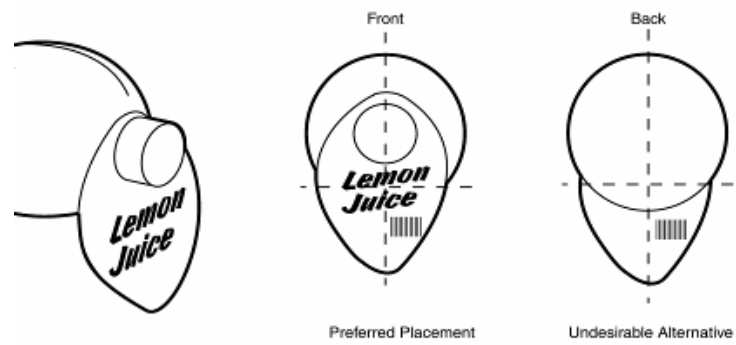

Figure 6.4.16-5. Giftware using hangtag



Figure 6.4.16-6. Tableware using spot label below backstamp



6.4.17 Sets (grouping of individually barcoded items)

For barcoding purposes, sets are defined as two or more items that are packaged and sold together as one unit, regardless of whether those items can be sold separately as well. If the items are packaged together for shipping purposes but are not intended to be sold as a single unit, they do not qualify as a set. Examples of sets include a pair of candlesticks, a set of four soup bowls, and a five-piece dinner place setting.

If a set is not intended to be sold as individual components, only the package for the set needs to include a barcode.

Figure 6.4.17-1. Example of a set where individual components are not sold separately

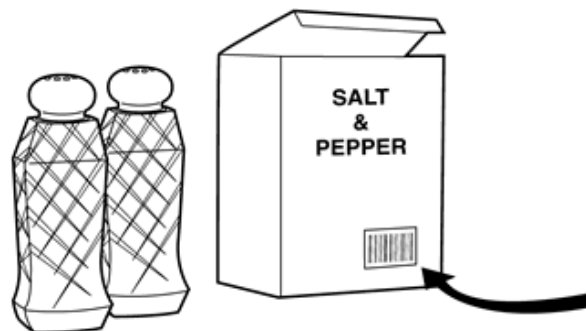

If the set is made up of components that can be ordered as separate trade items, then the components of the set must be marked. If the set can be sold as individual components or as the set, then both the package and the components need to be marked with unique symbols. The barcodes on the inner products must be totally obscured so that they cannot be read by the point-of-sale system when sold as a set. (See section [6.3.3.7](#) for over-wrap special considerations.)

Figure 6.4.17-2. Example of a multi-piece set sold as a set or as individual components

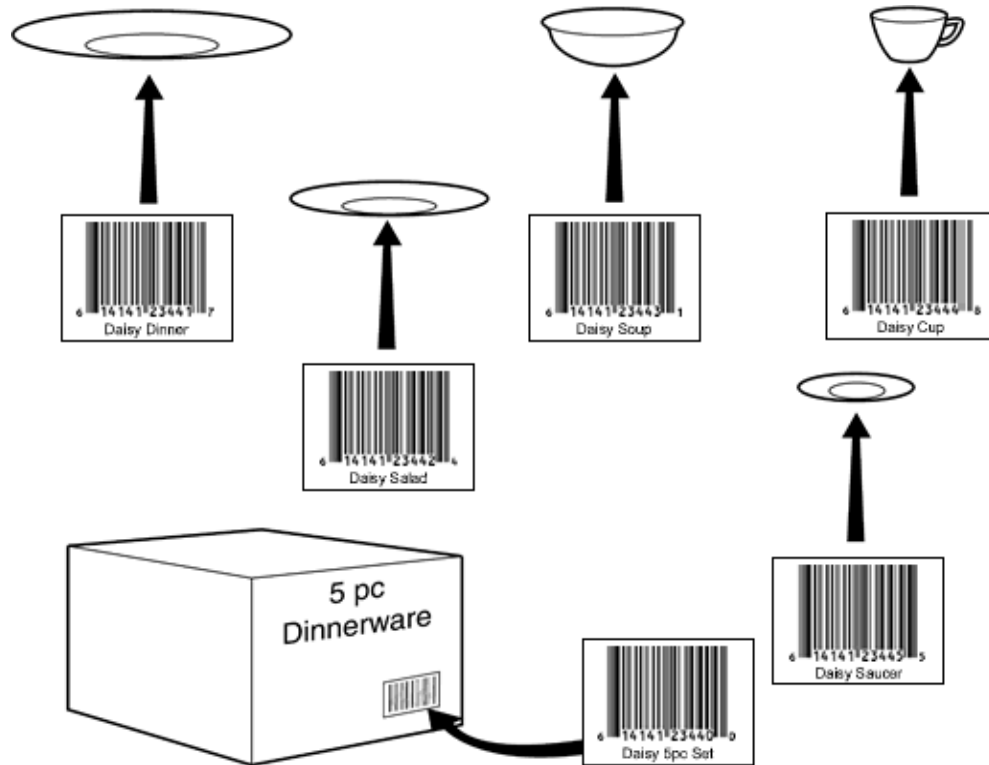

If an item is made up of multiple components that cannot be sold separately, such as a teapot with lid, the main piece only SHALL be marked with one symbol. Such items are not considered sets.

Figure 6.4.17-3. Items with multiple pieces that are not sold separately (these are not considered sets)

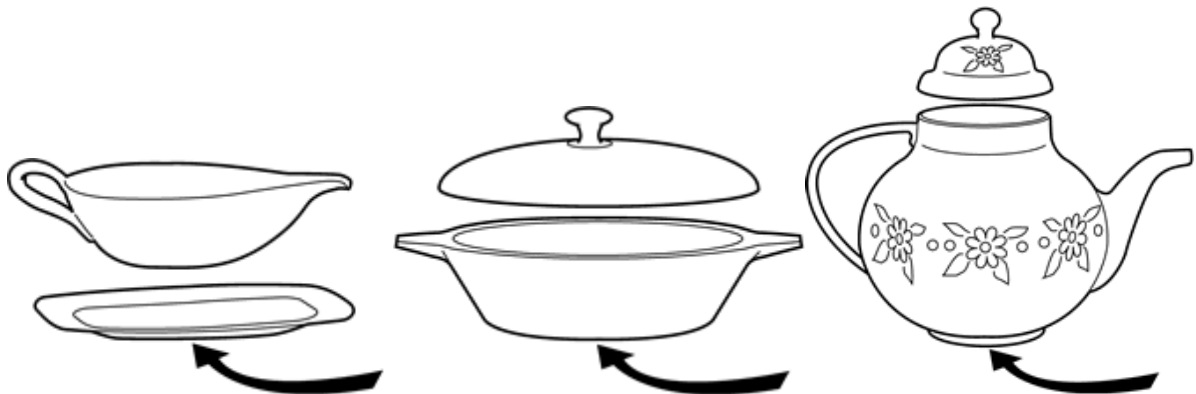

6.4.18 Sporting goods

Sporting goods is a category composed of many irregular sized and shaped goods. An understanding of each product type, the logistics involved in the supply chain, and the sales floor presentation are key to improving the overall point-of-sale efficiency. Of particular importance is consistent barcode placement for sporting goods as presented at the retail point-of-sale. This enables the point-of-sale operator to accurately predict the symbol location and thereby improve efficiency. The following examples, while not exhaustive, provide the general principles that are applied to similar product types.

6.4.18.1 Archery bows, arrows

- Preferred placement:
 - If packaged in boxes, see section [6.4.4](#).
 - If packaged using a hangtag, see section [6.5.2](#).
- Edge rule: See section [6.3.3.3](#).

Figure 6.4.18.1-1. Example barcode location on a crossbow

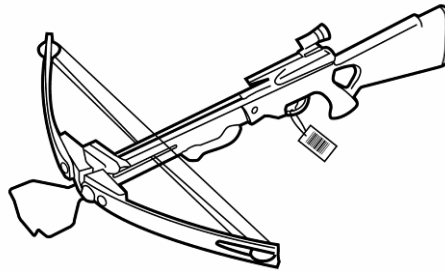

6.4.18.2 Balls, team sports

- Preferred placement:
 - If packaged individually, placement on the shrink wrap.
 - If packaged in boxes or boxed sets, see section [6.4.4](#) and section [6.4.17](#). If a master SKU is not utilised for a boxed set of balls or a pack set of ball and pump, each product type within the pack set SHALL have a screened barcode.
 - If not packaged, screen the barcode on the opposite side of the logo on the ball.
- Edge rule: See section [6.3.3.3](#)

Figure 6.4.18.2-1. Example barcode locations on a box of balls & separate balls

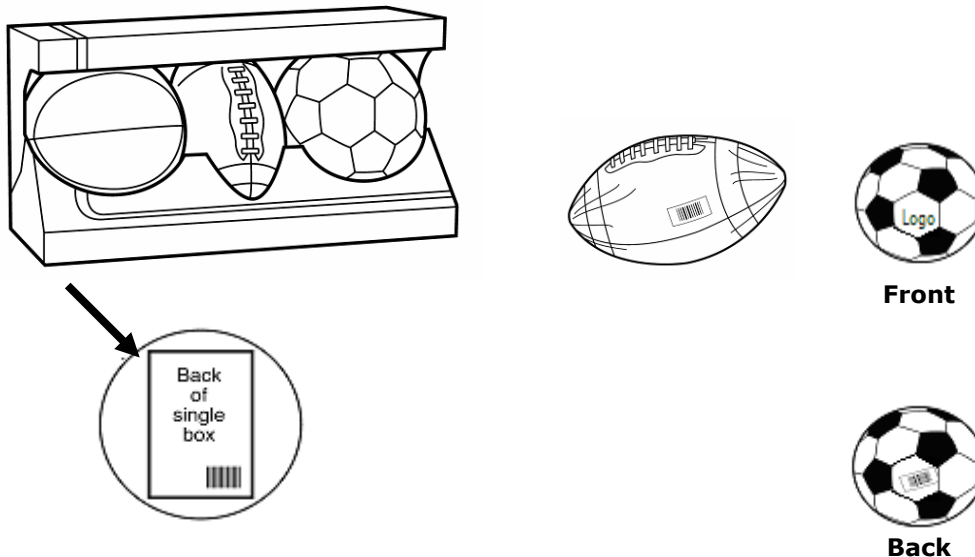

6.4.18.3 Bats, team sports

- Preferred placement: On the barrel handle of the bat, respecting the proper Quiet Zone areas around the barcode.

- Edge rule: See section [6.3.3.3](#)

Figure 6.4.18.3-1. Example barcode location on a baseball bat

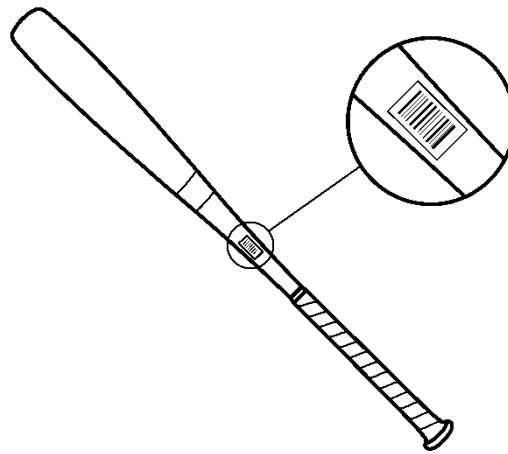

6.4.18.4 Bicycles

- Preferred placement: On the right hand fork of the bike, respecting the proper Quiet Zone areas around the barcode.
- Undesirable alternative: On a hangtag around the right hand brake cable, respecting the proper Quiet Zone areas around the barcode.
- Edge rule: See section [6.3.3.3](#)

Figure 6.4.18.4-1. Example barcode location on a bicycle

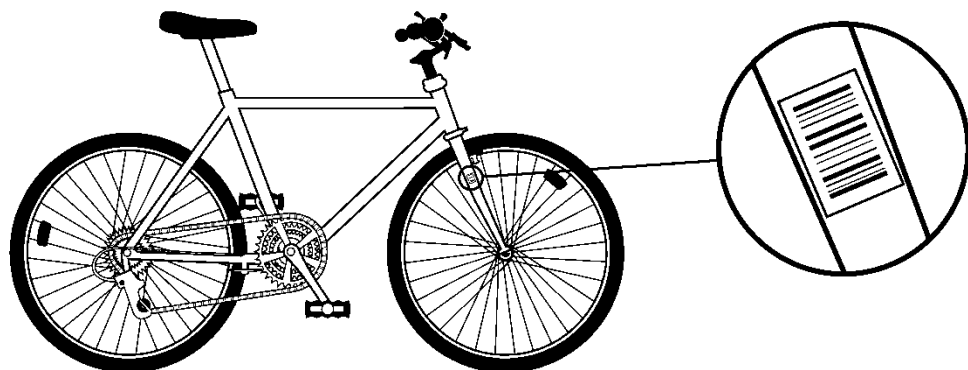

6.4.18.5 Climbing gear

- Preferred placement:
 - If packaged in boxes, see section [6.4.4](#)
 - If packaged using a hangtag, see section [6.5.2](#)
 - If packaged as carded items, see section [6.4.6](#)
- Edge rule: See section [6.3.3.3](#)

Figure 6.4.18.5-1. Example barcode locations on climbing gear

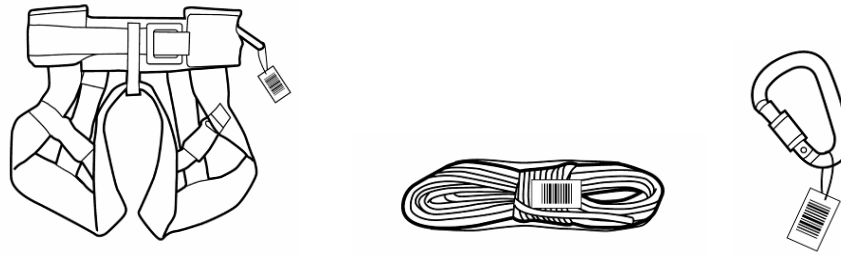

6.4.18.6 Fishing rods

- Preferred placement: On the grip of the fishing rod near the sealed end, respecting the proper Quiet Zone areas around the barcode. When a barcode is printed onto a curved surface, it is sometimes possible for the extremes of the symbol to disappear around the curve. See section [6.2.3.2](#) for the rules on the relationship between the diameter of the item and the X-dimension.
- Undesirable alternative: On a cardboard wrap or a hangtag on the shaft of the fishing rod, respecting the proper Quiet Zone areas around the barcode.
- Edge rule: See section [6.3.3.3](#)

Figure 6.4.18.6-1. Barcode location on a fishing rod

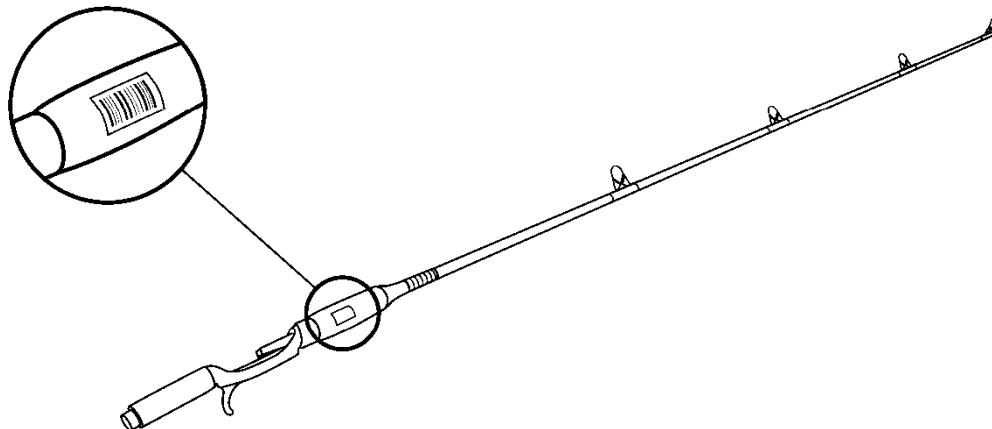

6.4.18.7 Fitness accessories

- Preferred placement:
 - If packaged in boxes, see section [6.4.4](#)
 - If packaged using a hangtag, see section [6.5.2](#)
 - If packaged as carded items, see section [6.4.6](#)
- Edge rule: See section [6.3.3.3](#)

Figure 6.4.18.7-1. Example barcode location on a box of fitness accessories

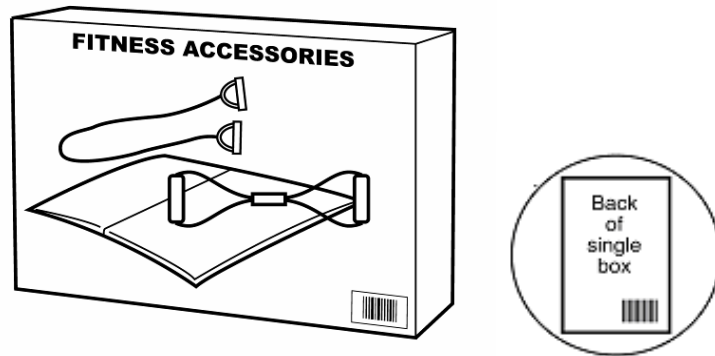

6.4.18.8 Gloves, mitts (sports)

- Preferred placement:
 - If packaged in boxes, see section [6.4.4](#)
 - If packaged using a hangtag, see section [6.5.2](#)
 - If packaged in bags, see section [6.4.1](#)
 - If not packaged, see section [6.4.9](#)
- Edge rule: See section [6.3.3.3](#)

Figure 6.4.18.8-1. Example barcode locations on gloves

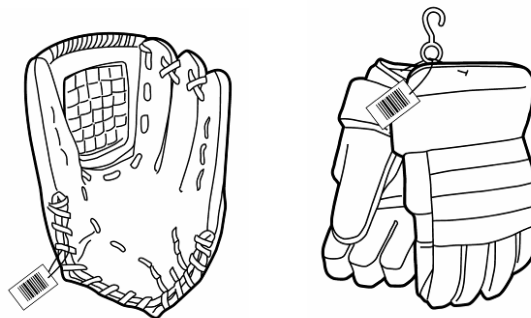

6.4.18.9 Golf club

- Preferred placement: On the shaft of the club located near the club head, respecting the proper Quiet Zone areas around the barcode. When a barcode is printed onto a curved surface, it is sometimes possible for the extremes of the symbol to disappear around the curve. See section [6.2.3.2](#) for the rules on the relationship between the diameter of the item and the X-dimension. Symbols SHALL NOT be located on the head of the golf club as symbols located on this flat area (normally preferable to locating barcodes on a curved surface) are easily damaged due to customer trials.
- Undesirable alternative: On the grip of the club near the sealed end, respecting the proper Quiet Zone areas around the barcode.
- Edge rule: See section [6.3.3.3](#)

Figure 6.4.18.9-1. Example barcode location on a golf club

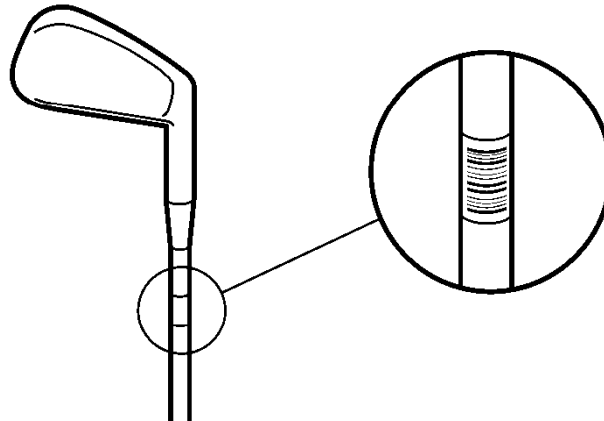

6.4.18.10 Guns

- Preferred placement:
 - If packaged using a hangtag, see section [6.5.2](#)
 - If packaged as a blister pack, see section [6.4.2](#)
 - If not packaged, placement near serial number
- Edge rule: See section [6.3.3.3](#)

Figure 6.4.18.10-1. Example barcode locations on a rifle and paint ball gun

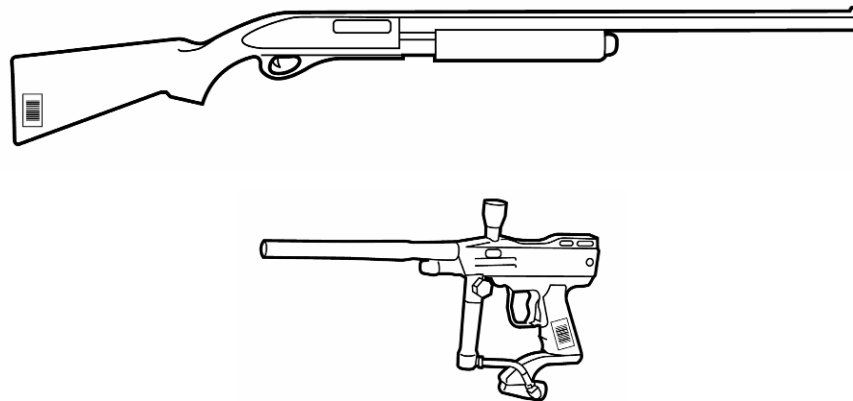

6.4.18.11 Helmets, masks (sports)

- Preferred placement:
 - If packaged in boxes, see section [6.4.4](#)
 - If packaged using a hangtag, see section [6.5.2](#)
 - If not packaged, see section [6.4.9](#)
- Edge rule: See section [6.3.3.3](#)

Figure 6.4.18.11-1. Example barcode location on a helmet

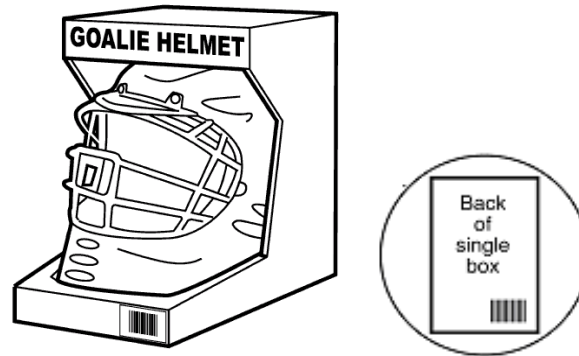

6.4.18.12 Ice-hockey and field hockey

- Preferred placement: On the flat blade of the stick, respecting the proper Quiet Zone areas around the barcode.
- Undesirable alternative: At the very top of the shaft of the stick, respecting the proper Quiet Zone areas around the barcode. When a barcode is printed onto a curved surface, it is sometimes possible for the extremes of the symbol to disappear around the curve. See section [6.2.3.2](#) for the rules on the relationship between the diameter of the item and the X-dimension.
- Edge rule: See section [6.3.3.3](#)

Figure 6.4.18.12-1. Example barcode location on an ice-hockey stick

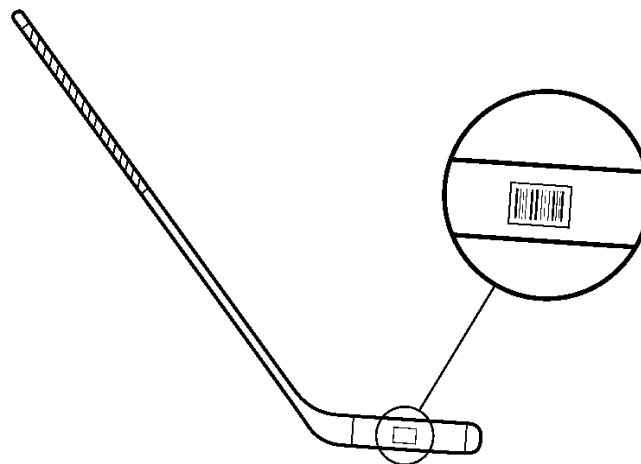

6.4.18.13 Multi-sports-product pack sets

- Preferred placement:
 - For placement on bags, see section [6.4.1](#)
 - For placement on hangtags, see section [6.5.2](#)
- Edge rule: See section [6.3.3.3](#)

Figure 6.4.18.13-1. Example barcode location on a product pack

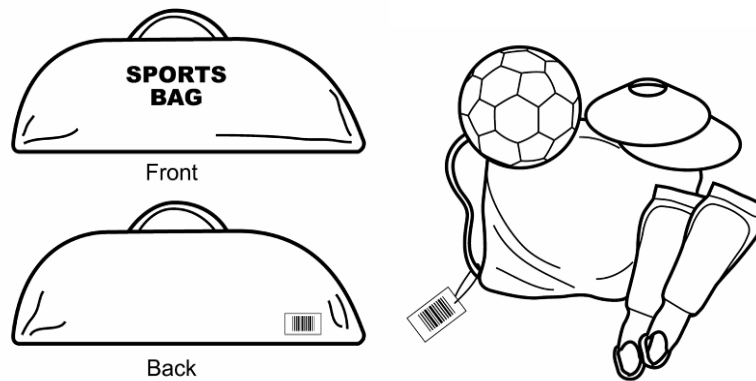

6.4.18.14 Pressure gauges and sports pumps

- Preferred placement:
 - If packaged as carded items, see section [6.4.6](#)
 - If packaged in bags, see section [6.4.1](#)
 - If not packaged, placement on the wrap band securing the tip/needles, etc.
- Edge rule: See section [6.3.3.3](#)

Figure 6.4.18.14-1. Example barcode location on a carded item

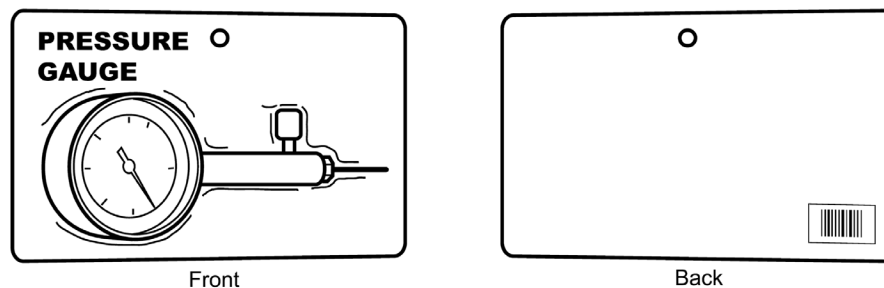

6.4.18.15 Protective gear, guards, vests

- Preferred placement:
 - If packaged as a carded item, see section [6.4.6](#)
 - If not packaged, see section [6.4.9](#)
- Edge rule: See section [6.3.3.3](#)

Figure 6.4.18.15-1. Example barcode location on guards

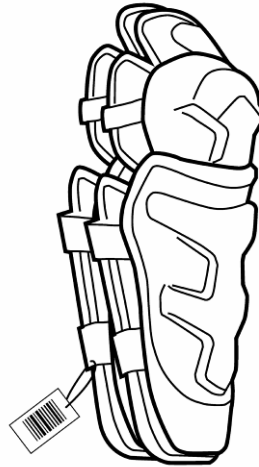

6.4.18.16 Racquets

- Preferred placement: On the grip of the racquet near the sealed end, respecting the proper Quiet Zone areas around the barcode. When a barcode is printed onto a curved surface it is sometimes possible for the extremes of the symbol to disappear around the curve. See section [6.2.3.2](#) for the rules on the relationship between the diameter of the item and the X-dimension.
- Undesirable alternative: On the cardboard wrap placed over the head of the racquet near the edge of the racquet head, respecting the proper Quiet Zone areas around the barcode.
- Edge rule: See section [6.3.3.3](#)

Figure 6.4.18.16-1. Example barcode location on a racquet

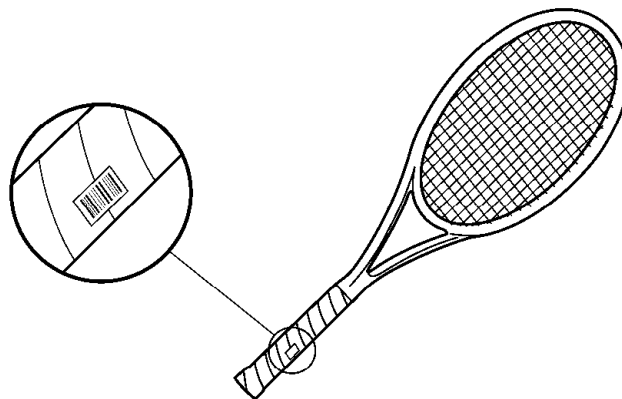

6.4.18.17 Skateboards

Skateboards are often displayed in their packages. See section [6.2.3](#), Orientation, to determine the back of the package. For unpackaged items:

- Preferred placement: On the bottom side of the skateboard on the top above the wheels, respecting the proper Quiet Zone areas around the barcode.
- Edge rule: See section [6.3.3.3](#)

Figure 6.4.18.17-1. Example barcode location on a skateboard

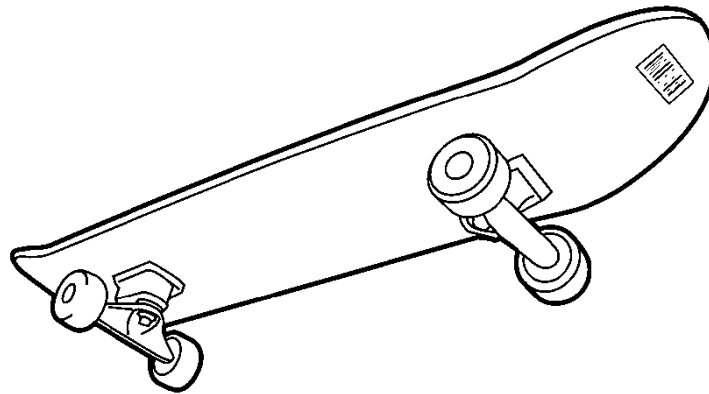

6.4.18.18 Skates

- Preferred placement:
 - If packaged in boxes, see section [6.4.4](#)
 - If packaged using hangtags, see section [6.5.2](#).
- Edge rule: See section [6.3.3.3](#)

Figure 6.4.18.18-1. Example barcode location on a box of skates

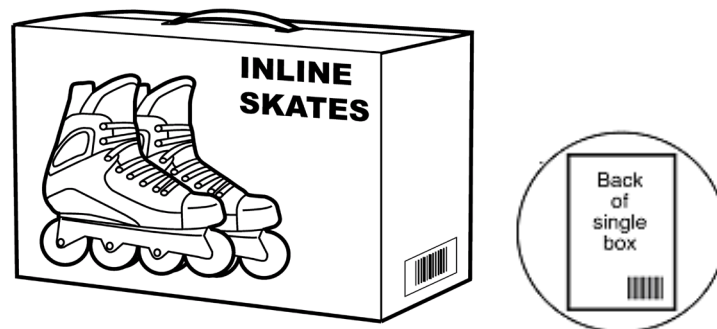

6.4.18.19 Skis

Skis are displayed without their packaging. The front of the ski is the side where the ski boots are placed and the back of the ski is the opposite side.

- Preferred placement: One barcode is placed on the back of the ski near the top of the ski, respecting the proper Quiet Zone areas around the barcode. Only one barcode is required per pair.
- Edge rule: See section [6.3.3.3](#)

Figure 6.4.18.19-1. Example barcode location on a ski

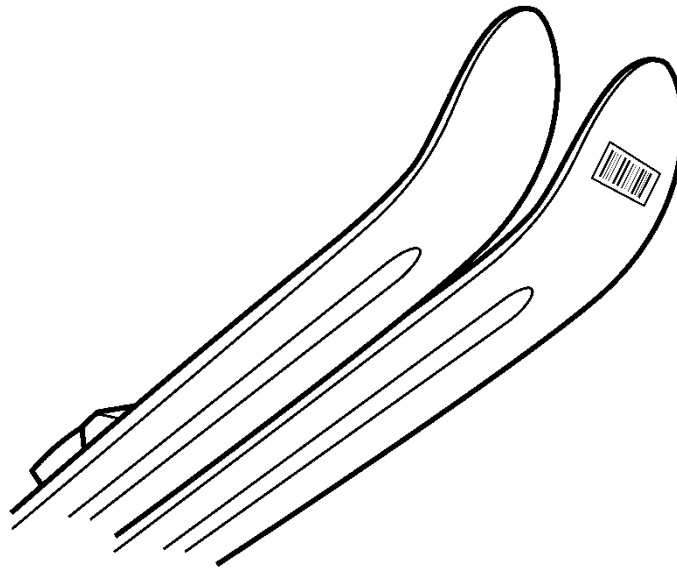

6.4.18.20 Water bottles (sports)

- Preferred placement:
 - If packaged in boxes, see section [6.4.4](#)
 - If packaged using hangtags, see section [6.5.2](#)
 - If not packaged, placement on the side of the bottle.
- Edge rule: See section [6.3.3.3](#)

Figure 6.4.18.20-1. Example barcode location on a water bottle

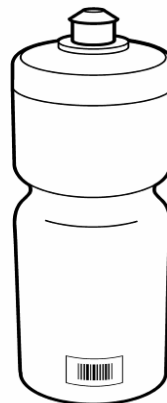

6.4.18.21 Water sports crafts

- Preferred placement:
 - If packaged in boxes, see section [6.4.4](#)
 - If packaged using hangtags, see section [6.5.2](#)
 - If not packaged, see section [6.4.9](#), Large, heavy, or bulky items
- Edge rule: See section [6.3.3.3](#)

Figure 6.4.18.21-1. Example barcode location on a canoe

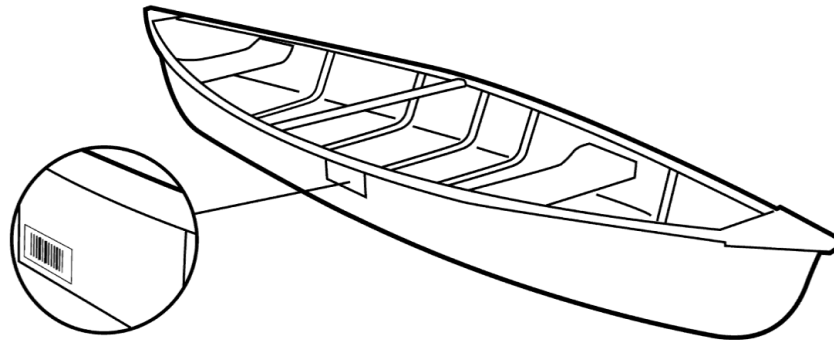

6.4.19 Textured surfaces

Some merchandise may not allow for application of barcode labels due to rough or textured surfaces. These surfaces can distort the label and thus the barcode. Alternative labelling options such as hang tags or loop tags may be necessary.

6.5 Symbol placement for clothing and fashion accessories

Clothing is displayed in a variety of ways, such as loose (e.g., hanging garments), in boxes, or in bags. In many cases, a relatively small label must carry all the pertinent information relevant to the product. A retail label normally carries not only product-specific information important to the retailer (e.g., die lot, batch) and consumer related information (e.g., style, size, colour), but also the barcode itself.

Figure 6.5-1. Example barcode location on boxes

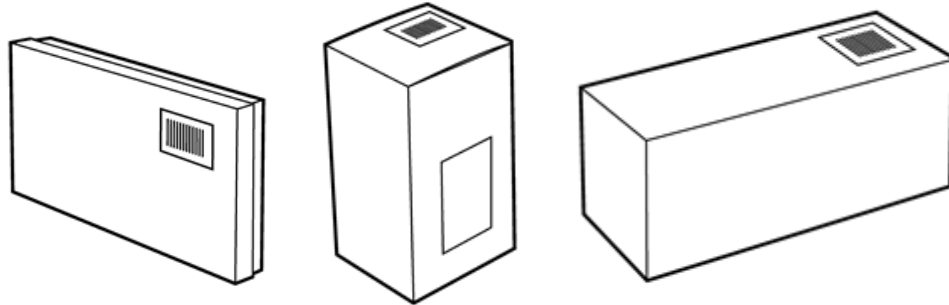

The correct general layout for a retail label is as follows. The label is divided into three portions:

- **Manufacturer/retailer information:** The upper portion of the format is the preferred location for non-HRI product information. This information is important to manufacturers and retailers, but usually not to the consumer.
- **Barcode:** The centre portion of the format is the best location for the barcode. Symbols in this location are the least likely to present obstructions to scanners because a natural boundary exists between the manufacturer/retailer information (upper portion) and the consumer information (lower portion).
- **Consumer information:** The lower portion of the format is the preferred location for information that is provided for the consumer, such as price, size, and fabric content.

The following sections show recommended placement of symbols on clothing and fashion accessories. To view illustrative images, please visit:

https://www.gs1.org/docs/barcodes/GenSpec_Fashion_symbol_location.pdf .

6.5.1 Information zones concept

There are seven information zones that carry product information needed for the vendor, retailer, and consumer. Some information is optional based upon the type of label.

6.5.1.1 General label information zones

Zones	Information type	Description	Status: Required/Optional
Zone 1	Merchandise identification	This is the primary human readable merchandise identifier, usually the style number, although it may be pattern, model, or garment type. The merchandise identifier is located in the upper left-hand portion of Zone 1.	Always required (see Note)
Zone 2	Vendor information	This includes optional vendor production information, such as vendor stock keeping unit (SKU), cut number, dye lot, colour, and pattern. (Vendor information helps ensure that the correct barcode is attached to the product.)	Optional
Zone 3	Data structure (GTIN-13, GTIN-12, GTIN-8)	Barcode	Always required
Zone 4	Consumer information	This includes optional product information for the consumer, such as fibre content, fire retardancy, and country of origin.	Optional
Zone 5	Size/dimension	Size/dimension is a key requirement for the consumer. Size information can be emphasised in large bold print and is located in the right-hand portion of Zone 5. Vendors may optionally include a style name as a selection aid for the consumer.	Usually required unless defined by the product (e.g., towels)
Zone 6	Retail price	<p>Allow space to print the price with minimum dimension characters of 25 mm (1 in.) x 32 mm (1.25 in.). For plastic packaged, boxed, and banded products, the required space for price can be provided by several methods:</p> <p>For barcode marking on an adhesive label, the space for price can be included as part of the label.</p> <p>For barcode marking designed into the packaging, the space for price can be included on the package artwork.</p> <p>Providing package space adjacent to Zone 5 that is reserved for retail item pricing creates an implied space for price. Implied space replaces the requirement for actual space on labels or package artwork.</p> <p>If implied space for price is used, no information of importance SHALL be printed in the area that might be covered by adhesive item price labels.</p>	Usually required unless defined by the ticket format (e.g., sewn-in tickets)
Zone 7	Manufacturer's suggested retail price	This is for use only if merchandise is pre-priced or the suggested retail price is printed on the tag. If provided, the area must be perforated for optional removal.	Optional
Note: Size and colour are optional in Zone 1 if vendor usage requires this information to define the product.			

6.5.1.2 General label format

See the figures 6.5.1.2-1 and 6.5.1.2-2 for examples of how the zones appear in a typical vertical and horizontal label format.

Figure 6.5.1.2-1. Vertical label format

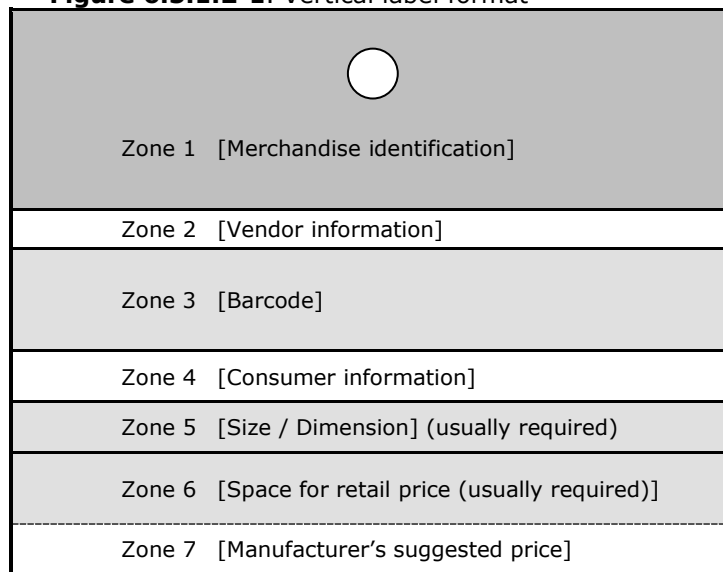
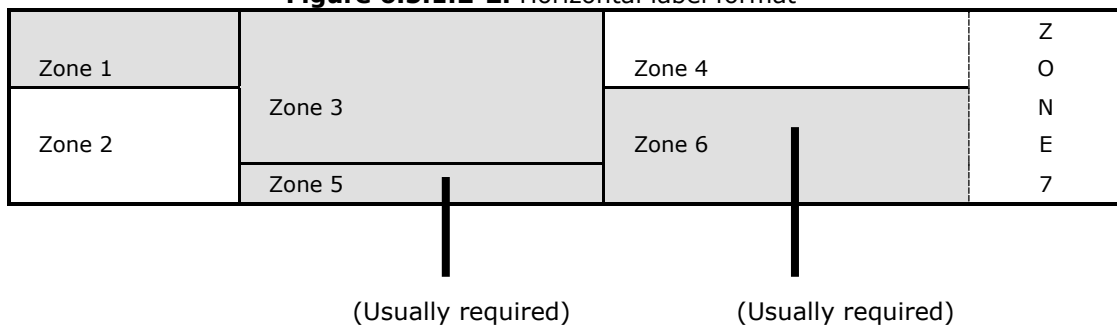

Figure 6.5.1.2-2. Horizontal label format



KEY

Required	Optional
----------	----------

6.5.2 Hangtag (hanging label) format

Although hangtags (hanging labels) are primarily associated with hanging ready-to-wear apparel, a wide variety of products are identified with hangtags. Flat-folded apparel, jewellery, belts, handbags, lamps, and furniture are all identified by some form of hangtag. Therefore, the voluntary hangtag format guidelines outlined in this section provide for flexibility in hangtag design while maintaining the overall concept of the information zones.

Hangtags serve a dual purpose. First, they provide brand identification to the consumer. Second, because the back of a hangtag is frequently used for product information and product identification codes, it SHALL carry the barcode that identifies the product.

The typical hangtag layout features the vendor's logo on the front and product identification codes and the barcode on the back. Vendors may optionally include an additional logo on the back of the hangtags. However, a logo SHALL NOT appear at the bottom because a retail price label may obscure it or it could be torn off if a manufacturer's suggested retail price is removed. Background printing of logos SHALL be avoided, because this may obscure required information or important consumer information. Logos must never obscure the barcode.

6.5.2.1 Hangtag label information zones

Zones	Information type	Description	Status: Required/ Optional
Zone 1	Merchandise identification	This is the primary human readable merchandise identifier, usually the style number, although it may be pattern, model, or garment type. The merchandise identifier SHALL be located in the upper left-hand portion of Zone 1.	Always required (see Note)
Zone 2	Vendor information	This includes optional vendor production information, such as vendor stock keeping unit (SKU), cut number, dye lot, colour, and pattern. (Vendor information helps ensure that the correct barcode is attached to the product.)	Optional
Zone 3	Data structure (GTIN-13, GTIN-12, GTIN-8)	Barcode	Always required
Zone 4	Consumer information	This includes optional product information for the consumer, such as fibre content, fire retardancy, and country of origin.	Optional
Zone 5	Size/dimension	Size/dimension is a key requirement for the consumer. Size information can be emphasised in large bold print and is located in the right-hand portion of Zone 5. Vendors may optionally include a style name as a selection aid for the consumer.	Usually required unless defined by the product (e.g., towels)
Zone 6	Retail price	Allow space to print the price with minimum dimension characters of 25 mm (1 in.) x 32 mm (1.25 in.).	Usually required unless defined by the ticket format (e.g., sewn-in tickets)
Zone 7	Manufacturer's suggested retail price	This is for use only if merchandise is pre-priced or the suggested retail price is printed on the tag. If provided, the area must be perforated for optional removal.	Optional

Note: Size and colour are optional in Zone 1 if vendor usage requires this information to define the product.

6.5.2.2 Hanging tag label examples

Figure 6.5.2.2-1. Hanging tag examples



6.5.3 Sewn-on (joker) label format

Used almost exclusively for apparel merchandise, joker labels are similar in format to hangtags, but differ in one important respect: They are sewn directly onto the product instead of hung from the product. Because it is sewn on, only one side of the label is available for the vendor's logo, the barcode, and merchandise identification information.

Inclusion of a vendor logo on the label is optional. If it is included, it SHALL NOT appear at the bottom, because it may be obscured by a retail price label, or it could be torn off by the removal of a manufacturer's suggested retail price. Background printing of logos SHALL be avoided, because this may obscure required information or important consumer information. Logos must never obscure the barcode.

6.5.3.1 Sewn-on (joker) label information zones

Zones	Information type	Description	Status: Required / Optional
Zone 1	Merchandise identification	This is the primary human readable merchandise identifier, usually the style number, although it may be pattern, model, or garment type. The merchandise identifier is located in the upper left-hand portion of Zone 1.	Always required (see Note)
Zone 2	Vendor information	This includes optional vendor production information, such as vendor stock keeping unit (SKU), cut number, dye lot, colour, and pattern. (Vendor information helps ensure that the correct barcode is attached to the product.)	Optional
Zone 3	Data structure (GTIN-13, GTIN-12, GTIN-8)	Barcode	Always required
Zone 4	Consumer information	This includes optional product information for the consumer, such as fibre content, fire retardancy, and country of origin.	Optional
Zone 5	Size/dimension	Size/dimension is a key requirement for the consumer. Size information can be emphasised in large bold print and SHALL be located in the right-hand portion of Zone 5. Vendors may optionally include a plain language style name on the size line as a selection aid for the consumer.	Usually required unless defined by the product (e.g., towels)
Zone 6	Retail price	Allow space to print the price with minimum dimension characters of 25 mm (1 in.) x 32 mm (1.25 in.).	Usually required unless defined by the ticket format (e.g., sewn-in tickets)
Zone 7	Manufacturer's suggested retail price	This is for use only if merchandise is pre-priced or the suggested retail price is printed on the tag. If provided, the area must be perforated for optional removal.	Optional
Note: Size and colour are optional in Zone 1 if vendor usage requires this information to define the product.			

6.5.3.2 Sewn-on (joker) label examples

Figure 6.5.3.2-1. Vertical layout

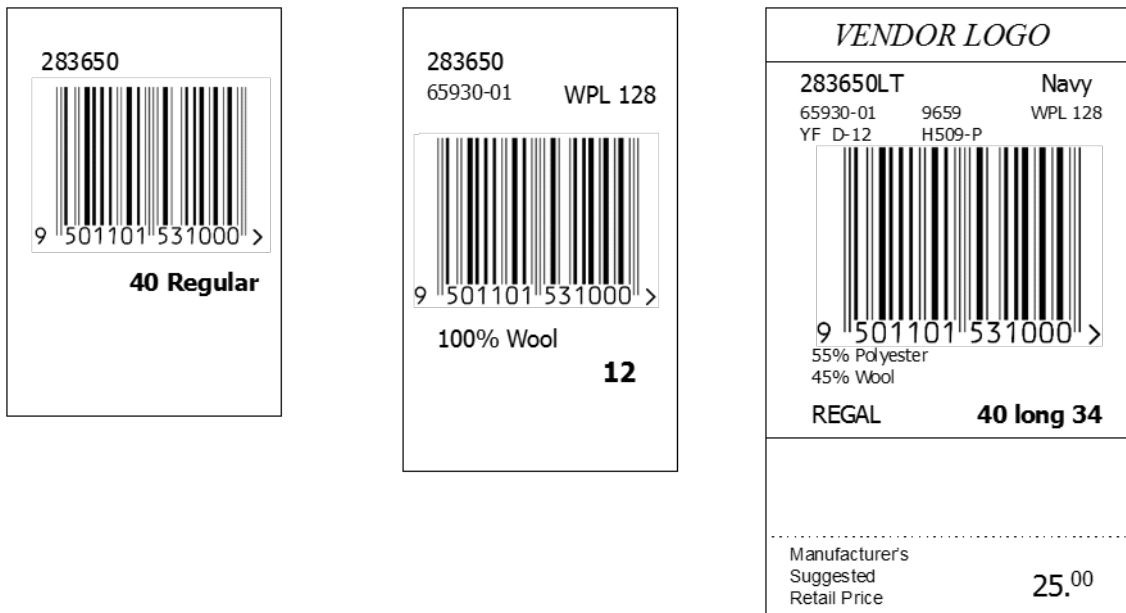
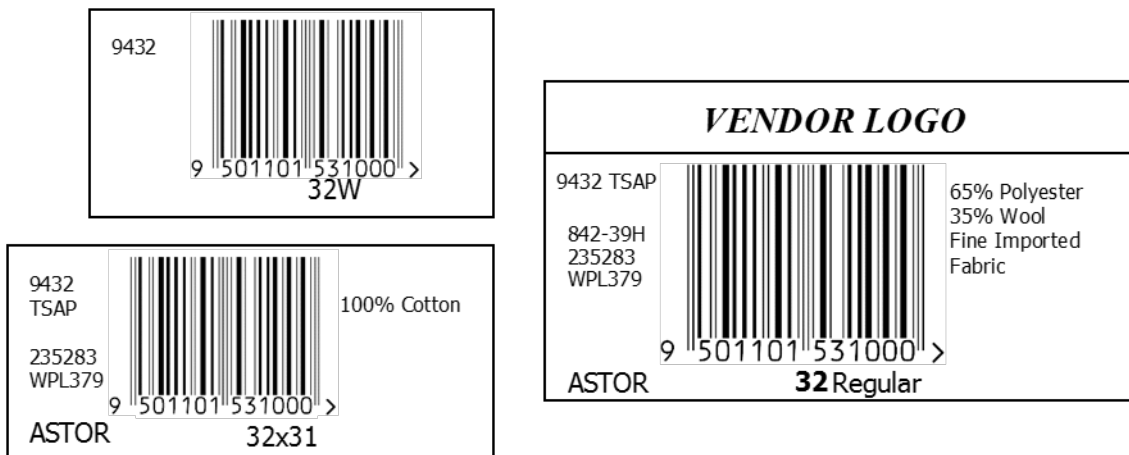

Figure 6.5.3.2-2. Horizontal layout



6.5.4 Sewn-in label formats

Sewn-in labels are often used for towel products. Sewn-in labels may be paper based, for removal by the consumer, or cloth based and more permanent.

Because a portion of the sewn-in label is normally covered by a hem, the label SHALL be designed with sufficient blank space on the end that will be attached to the product. Care must be taken to ensure that the product identification information on the label is not obscured by the hem and that it does not interfere with the readability of the barcode at the point-of-sale.

6.5.4.1 Sewn-in label information zones

Zones	Information Type	Description	Status: Required/Optional
Zone 1	Merchandise identification	This is the primary human readable merchandise identifier, usually the style number, although it may be pattern, model, or garment type. The merchandise identifier is located in the upper left-hand portion of Zone 1.	Always required (see Note)
Zone 2	Vendor information	This includes optional vendor production information, such as vendor stock keeping unit (SKU), cut number, dye lot, colour, and pattern. (Vendor information helps ensure that the correct barcode is attached to the product.)	Optional
Zone 3	Data structure (GTIN-13, GTIN-12, GTIN-8)	Barcode	Always required
Zone 4	Consumer information	This includes optional product information for the consumer, such as fibre content, fire retardancy, and country of origin.	Optional
Zone 5	Size/dimension	Size or dimension is optional for sewn-in labels. Size or dimension may assist the consumer with product selection or may help the vendor ensure that the correct label and barcode are attached to the product.	Usually required unless defined by the product (e.g., towels) and readily apparent to the consumer.
Zone 6	Retail price	Allow space to print the price with minimum dimension characters of 25 mm (1 in.) x 32 mm (1.25 in.).	Usually required unless defined by the ticket format (e.g., sewn-in tickets)
Zone 7	Manufacturer's suggested retail price	This is for use only if merchandise is pre-priced or the suggested retail price is printed on the tag. If provided, the area must be perforated for optional removal.	Optional
Note: Size and colour are optional in Zone 1 if vendor usage requires this information to define the product.			

6.5.5 Plastic packaged products label location guidelines

The plastic packaged category covers a wide assortment of merchandise, including sheets, pillowcases, table linens, pantyhose, underwear, stationery supplies, pillows, bedspreads, and numerous types of flat-folded apparel that are plastic packaged. There are two methods of marking plastic packaged products with barcodes:

1. Incorporate the barcode and other merchandise identification information into the packaging's artwork.
2. Print the barcode and other merchandise identification information on an adhesive label that can be press-applied to the product.

Inclusion of a vendor logo on the label is optional. If it is included, the logo SHALL NOT appear at the bottom, because it may be obscured by a retail price label, or it could be torn off by the removal of a manufacturer's suggested retail price. Background printing of logos SHALL be avoided, because this may obscure required information or important consumer information. Logos must never obscure the barcode.

6.5.5.1 Plastic packaged products label information zones

Zones	Information Type	Description	Status: Required/Optional
Zone 1	Merchandise identification	This is the primary human readable merchandise identifier, usually the style number, although it may be pattern, model, or garment type. The merchandise identifier is located in the upper left-hand portion of Zone 1.	Always required (see Note 1)
Zone 2	Vendor information	This includes optional vendor production information, such as vendor stock keeping unit (SKU), cut number, dye lot, colour, and pattern. (Vendor information helps to ensure that the appropriate barcode is attached to the product.)	Optional
Zone 3	Data structure (GTIN-13, GTIN-12, GTIN-8)	Barcode	Always required
Zone 4	Consumer information	This includes optional product information for the consumer, such as fibre content, fire retardancy, and country of origin.	Optional (see Note 2)
Zone 5	Size/dimension	Size/dimension is a key requirement for the consumer. Size information can be emphasised in large bold print and is located in the right-hand portion of Zone 5. Vendors may optionally include a style name as a selection aid for the consumer.	Usually required (see Note 3)
Zone 6	Retail price	Allow space to print the price with 25 mm (1 in.) x 32 mm (1.25 in.) minimum dimension characters. For plastic packaged products, this required space for price can be provided by several methods: For barcode marking on an adhesive label, the space for price can be included as part of the label. For barcode marking designed into the packaging, the space for price can be included on the package artwork. Providing package space adjacent to Zone 5 that is reserved for retail item pricing creates an implied space for price. Implied space replaces the requirement for actual space on labels or package artwork. If implied space for price is used, no information of importance SHALL be printed in the area that might be covered by adhesive item price labels.	Usually required
Zone 7	Manufacturer's suggested retail price	This is for use only if merchandise is pre-priced or the suggested retail price is printed on the tag. If provided, the area must be perforated for optional removal.	Optional

Note 1: Size and colour are optional in Zone 1 if vendor usage requires this information to define the product.

Note 2: Some jurisdictions require that certain products include a permanently affixed statement of information of this type in Zone 4 that may not be satisfied by inclusion on the package.

Note 3: Size may be omitted from Zone 5 if the size information is readily available on the product packaging.

6.5.5.2 Plastic packaged products label placement guidelines

Consistent barcode placement is required for successful scanning at the point-of-sale. The symbol placement guidelines for plastic packaged products have been designed with the flexibility to accommodate differences that may arise from industry to industry:

- On plastic packaged products, the front top right-hand corner is the preferred placement for the barcode and other product identification information.
- The barcode and other product identification information may be located on the front or back of plastic packaged products. However, all products within a particular merchandise category must have their barcodes placed on the same side of the package.

Caution: Placement of the barcode on the back of a product may result in the presentation of the product on the display counter in a backside up orientation by some retailers so that the barcode and retail price appear together in full view by the customer.

- The orientation of the barcode and other product identification information SHALL be consistent with any graphics or descriptive data on the plastic package.
- Where possible, the symbol and other product identification information, whether built into the package artwork or an adhesive label, must not be closer than 8 millimetres (0.3 inch) or farther than 100 millimetres (4 inches) from the nearest edge of the package. Experience has shown that the previously recommended minimum distance of 5 millimetres (0.2 inch) is inadequate. Also, cashiers often grab packages on the edge with their thumbs. Avoid placing the barcode too close to the edge. Such placement reduces point-of-sale efficiency and may cause distortion of the symbol. (See section [6.3.3.3](#), Edge rule.)
- The barcode and other product identification information on plastic packaged products is normally to be located on the front top right-hand corner. However, for very large, bulky, or unusually shaped products, this may be impractical or inappropriate. See section [6.4.9](#) for information on large, heavy, and bulky items.

Note: Section [6.4](#) specifies the lower right quadrant of the back of the package or container as the recommended location for the barcode. This recommendation applies to plastic packaged products that are sold in a grocery store environment.

6.5.5.3 Plastic packaged products label example

Figure 6.5.5.3-1. Plastic packaged products label example

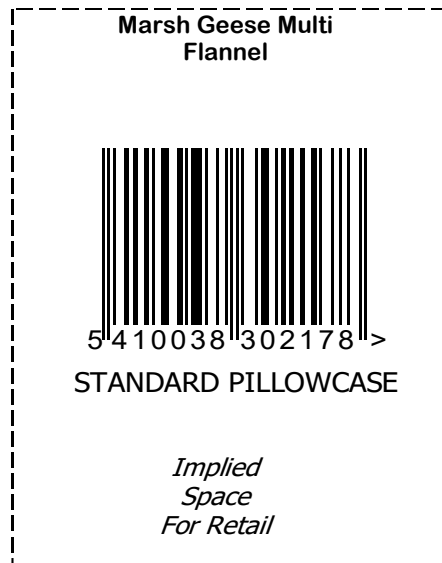

6.5.6 Boxed products label formats

Some boxed products may be sold in or out of the box. Other boxed products are actually sets that may also be sold as individual items. Some boxes carry significant amounts of design graphics, while others are plain boxes containing the product.

Box size can range from very small, as in jewellery or cosmetics, to very large, as in home furnishings. For extremely large boxed products, consider using a two-part tear-off barcode label to facilitate scanning at the point-of-sale while leaving one label on the box.

There are two methods of marking boxed products with barcodes:

- Incorporate the barcode and other merchandise identification information the box’s artwork.
- Print the barcode and other merchandise identification information on an adhesive label that can be affixed to the box.

Inclusion of a vendor logo in the box marking format is optional. If the logo is included, it SHALL NOT appear at the bottom, because it may be obscured by a retail price label, or it could be torn off if a manufacturer's suggested retail price is removed. Background printing of logos SHALL be avoided, because this may obscure required information or important consumer information.

6.5.6.1 Boxed products label information zones

Zones	Information Type	Description	Status: Required/Optional
Zone 1	Merchandise identification	This is the primary human readable merchandise identifier, usually the style number, although it may be pattern, model, or garment type. The merchandise identifier is located in the upper left-hand portion of Zone 1.	Always required (see Note 1)
Zone 2	Vendor information	This includes optional vendor production information, such as vendor stock keeping unit (SKU), cut number, dye lot, colour, and pattern. (Vendor information helps ensure that the correct barcode is attached to the product.)	Optional
Zone 3	Data structure (GTIN-13, GTIN-12, GTIN-8)	Barcode	Always required
Zone 4	Consumer information	This includes optional product information for the consumer, such as fibre content, fire retardancy, and country of origin.	Optional (see Note 2)
Zone 5	Size/dimension	Size/dimension is a key requirement for the consumer. Size information can be emphasised in large bold print and is located in the right-hand portion of Zone 5. Vendors may optionally include a style name as a selection aid for the consumer.	Usually required (see Note 3)
Zone 6	Retail price	Allow space to print the price with minimum dimension characters of 25 mm (1 in.) x 32 mm (1.25 in.). For boxed products, this required space for price can be provided by several methods: For barcode marking on an adhesive label, the space for price can be included as part of the label. For barcode marking designed into the packaging, the space for price can be included on the package artwork. Providing package space adjacent to Zone 5 that is reserved for retail item pricing creates an implied space for price. Implied space replaces the requirement for actual space on labels or package artwork. If implied space for price is used, no information of importance is printed in the area that might be covered by adhesive item price labels.	Usually required
Zone 7	Manufacturer’s suggested retail price	For use only if merchandise is pre-priced or the suggested retail price is printed on the tag. If provided, the area must be perforated for optional removal.	Optional
<p>Note 1: Size and colour are optional in Zone 1 if vendor usage requires this information to define the product.</p> <p>Note 2: Some jurisdictions require that certain products include a permanently affixed statement of information of this type in Zone 4 that may not be satisfied by inclusion on the package.</p> <p>Note 3: Size may be omitted from Zone 5 if the size information is readily available on the product packaging.</p>			

6.5.6.2 Packaged versus freestanding single selling units

Certain single selling units (trade items) may be sold as freestanding items, or they may be sold in a package. This creates a dilemma for the supplier: to mark the item or mark the package? For the definition of a trade item pertaining to this scenario, see section [2.1](#).

6.5.6.3 Boxed products label placement guidelines

Consistent barcode placement within an industry or product category is required if merchandise carrying a barcode is to successfully scan at the point-of-sale. Since the category of boxed products includes a diverse merchandise group, location guidelines have been designed with considerable flexibility to accommodate differences that may arise from industry to industry:

- The exposed surface of the box is the preferred location for barcodes and other product identification information on boxed products sold primarily in the department or specialty store environment.
 - The orientation of the barcode and other product identification information SHALL be consistent with any graphics or descriptive data on the box.
 - Where possible, the symbol and other product identification information, whether built into the package artwork or an adhesive label, must not be closer than 8 millimetres (0.3 inch) or farther than 100 millimetres (4 inches) from the nearest edge of the package. Experience has shown that the previously recommended minimum distance of 5 millimetres (0.2 inch) is inadequate. Also, cashiers often grab packages on the edge with their thumbs. Avoid placing the barcode too close to the edge. Such placement reduces point-of-sale efficiency and may cause distortion of the symbol. (See section [6.3.3.3](#), Edge rule.)
 - The barcode and other product identification information on plastic packaged products is normally to be located on the front top right-hand corner. However, for very large, bulky, or unusually shaped products, this may be impractical or inappropriate. See section [6.4.9](#) for information on large, heavy, and bulky items.
- ✓ **Note:** Section [6.4](#) specifies the lower right quadrant of the back of the package or container as the recommended location of the barcode. This recommendation applies to plastic packaged products that are sold in a grocery store environment.

6.5.6.4 Boxed products label examples

Figure 6.5.6.4-1. Label examples for boxed products

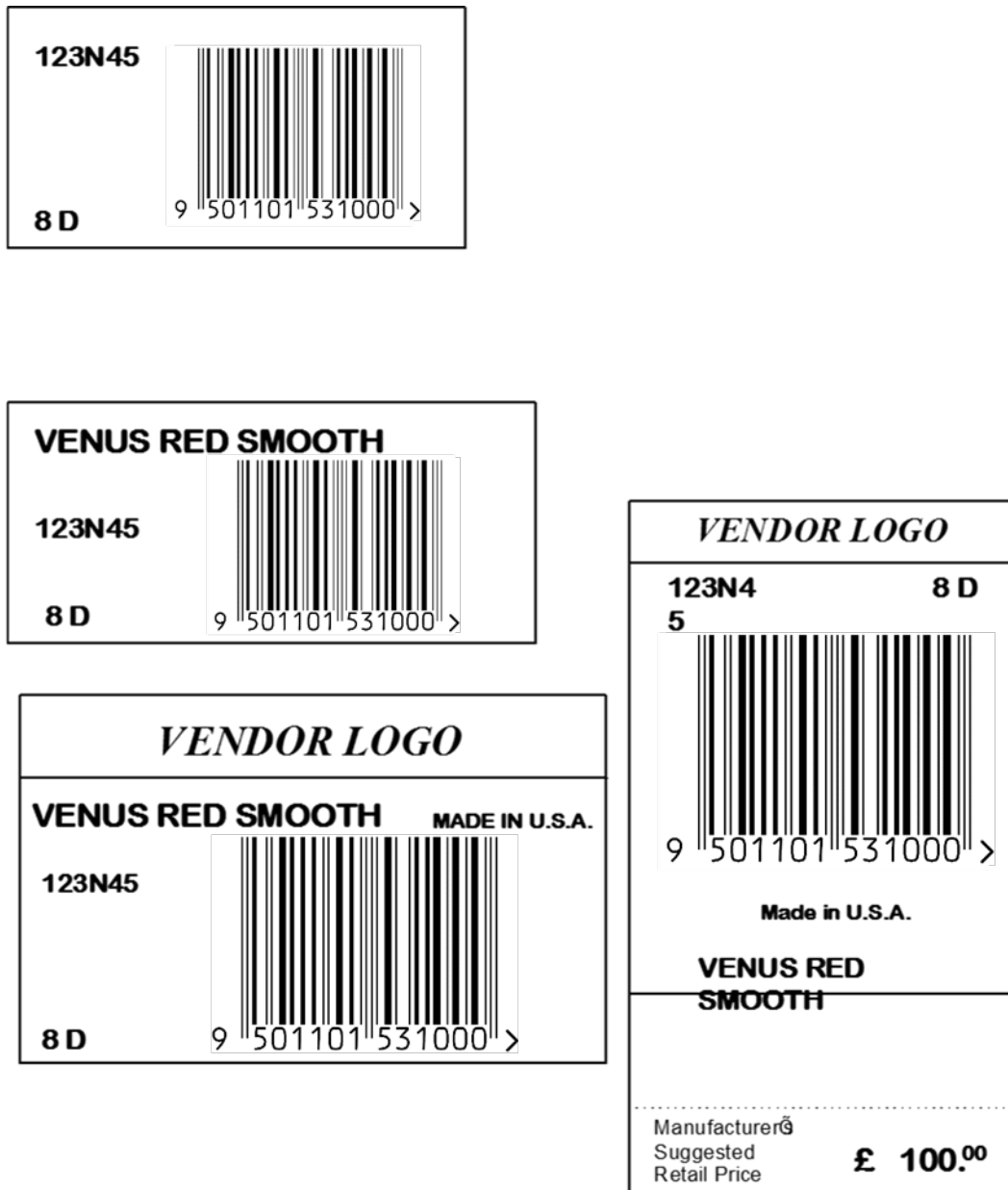

6.5.7 Banded products label formats

Banded packaging involves a specialised group of products. This type of packaging is most commonly associated with hosiery (socks) or yarn products. There are the two methods of marking banded products with barcodes:

- Incorporate the barcode and other merchandise identification information into the band's artwork.
- Print the barcode and other merchandise identification information on an adhesive label that can be applied to the band.

The typical banded product label has the vendor's logo on the front and the product identification codes, consumer information, and barcode on the back. The vendor's logo can also be printed on

the back of the band as part of the band marking format. However, care **MUST** be taken to ensure that there is no obstruction of the barcode or other important product identification information. Background printing of logos **SHALL** be avoided.

6.5.7.1 Banded products label information zones

Zones	Information Type	Description	Status: Required/Optional
Zone 1	Merchandise identification	This is the primary human readable merchandise identifier, usually the style number, although it may be pattern, model, or garment type. The merchandise identifier is located in the upper left-hand portion of Zone 1.	Always required (see Note 1)
Zone 2	Vendor information	This includes optional vendor production information, such as vendor stock keeping unit (SKU), cut number, dye lot, colour, and pattern. (Vendor information helps ensure that the correct barcode is attached to the product.)	Optional
Zone 3	Data structure (GTIN-13, GTIN-12, GTIN-8)	Barcode	Always required
Zone 4	Consumer information	This includes optional product information for the consumer, such as fibre content, fire retardancy, and country of origin.	Optional (see Note 2)
Zone 5	Size/dimension	Size/dimension is a key requirement for the consumer. Size information can be emphasised in large bold print and is located in the right-hand portion of Zone 5. Vendors may optionally include a style name as an aid to the consumer in selection.	Usually required (see Note 3)
Zone 6	Retail price	<p>Allow space to print the price with minimum dimension characters of 25 mm (1 in.) x 32 mm (1.25 in.). For banded products, this required space for price can be provided by several methods:</p> <p>For barcode marking on an adhesive label, the space for price can be included as part of the label.</p> <p>For barcode marking designed into the packaging, the space for price can be included on the package artwork.</p> <p>Providing package space adjacent to Zone 5 that is reserved for retail item pricing creates an implied space for price. Implied space replaces the requirement for actual space on labels or package artwork.</p> <p>If implied space for price is used, no information of importance is printed in the area that might be covered by adhesive item price labels.</p>	Usually required
Zone 7	Manufacturer's suggested retail price	This is for use only if merchandise is pre-priced or the suggested retail price is printed on the tag. If provided, the area must be perforated for optional removal.	Optional
<p>Note 1: Size and colour are optional in Zone 1 if vendor usage requires this information to define the product.</p> <p>Note 2: Some jurisdictions require that certain products include a permanently affixed statement of information of this type in Zone 4 that may not be satisfied by inclusion on the package.</p> <p>Note 3: Size may be omitted from Zone 5 if the size information is readily available on the product packaging.</p>			

6.6 GS1 Logistics Label design

These specifications constitute the basis for all GS1 Logistics Labels. Other sections, most notably section 3, GS1 Application Identifier definitions, and section 5.4, GS1-128 symbology specifications, MUST be read in conjunction with the following sub-sections.

6.6.1 Scope

These specifications detail the structure and layout of GS1 Logistics Labels. Emphasis is given to the basic requirements for practical application in an open trade environment. Primary topics include:

- The unambiguous identification of logistic units.
- The efficient presentation of text and machine readable data.
- The information requirements of the key partners in the supply chain: suppliers, customers, and carriers.
- Technical parameters to ensure systematic and stable interpretation of labels.

6.6.2 Concepts

6.6.2.1 Logistics information flow

As a logistic unit moves through the supply chain, a series of events occurs that defines the information related to the unit. The whole supply chain process of manufacturing, finished goods distribution, transportation, and deployment into the marketplace adds layers of information related to the logistic unit.

For example, the physical content of the unit is typically defined at finished goods distribution. At that point in time the identification of the logistic unit as an entity is possible. Other elements of information, such as final destination or the composition of a multi-unit shipment, are not typically known until later in the supply chain process. In a trading relationship, different elements of information are generally known and applied by the supplier, carrier, and customer.

Figure 6.6.2.1-1. Logistics information flow



6.6.2.2 Representation of information

The information included on a GS1 Logistics Label comes in two basic forms.

1. Information to be used by people: This is comprised of HRI, non-HRI text and graphics.
2. Information designed for data capture by a machine: Barcodes.

Barcodes are machine readable and are a secure and efficient method for conveying structured data, while HRI, non-HRI text and graphics allow people general access to basic information at any point in the supply chain. Both methods add value to GS1 Logistics Labels, and often co-exist on the same label.

6.6.3 GS1 Logistics Label design

The GS1 Logistics Label information may be grouped into logical segments for the supplier, customer, and carrier. Each label segment may be applied to the logistic unit at a different point in time as the relevant information becomes known.

In addition to this, on the GS1 Logistics Label a distinction can be made between the types of data communicated on the GS1 Logistics Label, in order to facilitate interpretation by machines and people. For this purpose the data can be expressed in three types of building blocks:

1. Free format,
2. Non-HRI text including data titles,
3. Barcodes and HRI.

When segments are used, within the segments the data still need to be organised using building blocks. In that case segments are the primary grouping mechanism; building blocks are subordinate to that.

The SSCC is the single mandatory element for all GS1 Logistics Labels. Other information, when required, SHALL comply with the specifications in this document and with the proper use of GS1 Application Identifiers.

6.6.3.1 Segments

A segment is a logical grouping of information that is generally known at a particular time. There may be up to three label segments on a GS1 Logistics Label, each representing a group of information. Generally, the order of the segments, from top to bottom, is: carrier (transport), customer, and supplier. However, this order and top/down alignment may vary depending on the size of the logistic unit and the business process being served.

Segments may be printed separately in which case they must be placed vertically in close proximity of each other, with the segment containing the SSCC at the bottom. The carrier segment may be replaced during the journey of the logistic unit, in which case special care should be taken to ensure the customer and supplier segments are preserved.

Figure 6.6.3.1-1. Examples of segmented label structures

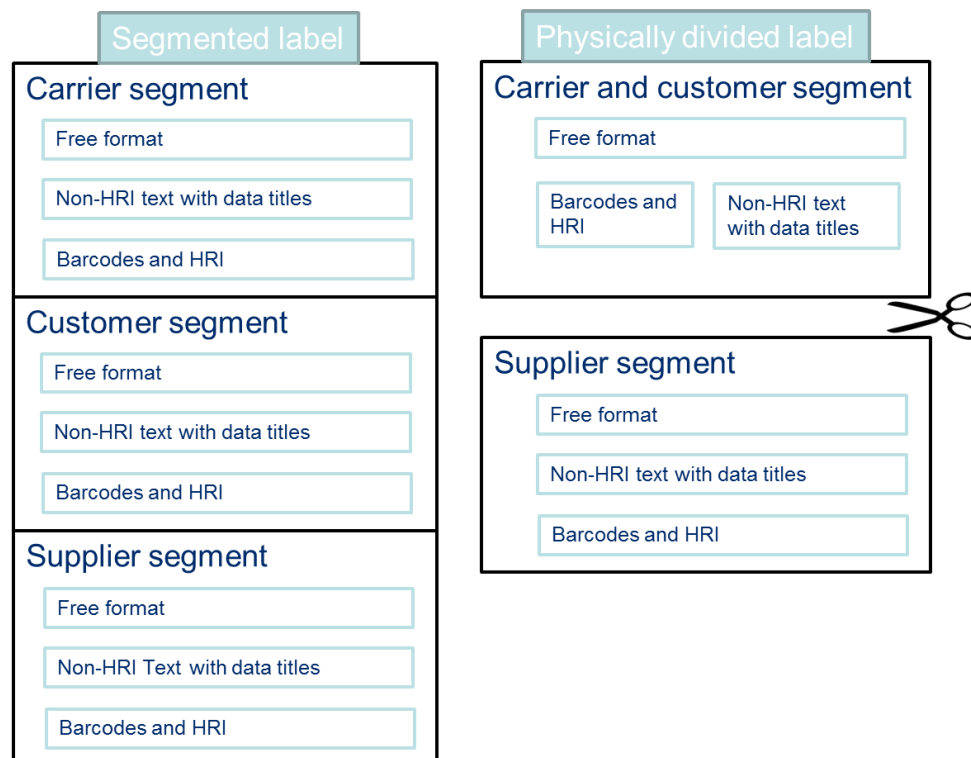

6.6.3.1.1 Supplier segment

The supplier segment of the label contains information that is generally known at the time of packaging by the supplier. The SSCC is applied here as the logistic unit identifier, along with the Global Trade Item Number (GTIN) if included on the label.

Other information that may be of interest to the supplier but might also be useful for customers and carriers can be applied. This includes product-related information such as product variant; dates such as production, packaging, expiration, and best-before dates; and lot, batch, and serial numbers.

6.6.3.1.2 Customer segment

The customer segment of the label contains information that is generally known at the time of order and order processing by the supplier. Typical information includes the ship to location, purchase order number, and customer-specific routing and handling information. If several logistic units are assembled to be transported under one despatch advice or Bill of Lading (BOL) to one customer the GSIN, AI (402) may also be applied in this customer segment.

6.6.3.1.3 Carrier (transport) segment

The carrier (transport) segment of the label contains information that is generally known at the time of shipment and is typically related to transport. Typical information includes ship to postal codes, AI (420), Global Identification Number for Consignment, AI (401), and carrier-specific routing and handling information.

6.6.3.2 Building blocks

On the GS1 Logistics Label a distinction is made between the type of data communicated using three types of building blocks:

1. The 'Free format' building block may contain non-HRI text and graphics.
2. The 'non-HRI text including data titles' building block contains non-HRI text reflecting the information represented in the barcode(s) using data titles rather than AIs, and optionally additional information not represented in barcodes (preferably including data titles).
3. The 'Barcodes and HRI' building block contains the barcode(s) including human readable interpretation (HRI).

On the label and within label segments the building blocks are usually placed top down: Free format (top), non-HRI text including data titles (middle), Barcodes and HRI (bottom). If space permits it, and providing the barcodes conform to the size specifications for the application, the lower two building blocks may be placed side by side. See figure 6.7.3.1-1.

Figure 6.6.3.2-1. Placement of building blocks

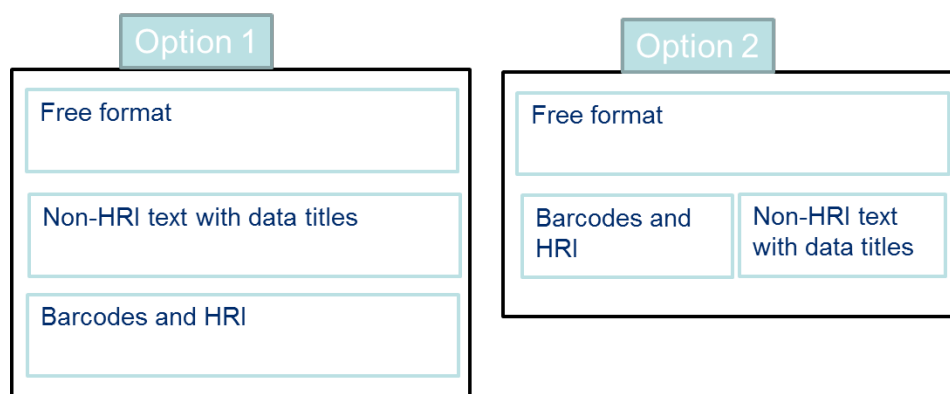

6.6.4 Technical specifications

6.6.4.1 Barcodes and human readable interpretation

6.6.4.1.1 Barcode orientation and placement

Barcodes must be placed in a picket fence orientation relative to the base of a logistic unit, this means, the bars and spaces are perpendicular to the base on which the logistic unit stands. In all cases, the GS1-128 barcode encoding the SSCC SHALL be placed in the lowest portion of the label.

6.6.4.1.2 Human readable interpretation

As a back-up key entry and diagnostic aid, a human readable interpretation (HRI) of each barcode SHALL be provided. HRI rules for barcodes are maintained in section [4.14](#).

6.6.4.2 Non-HRI text including data titles

Text with data titles is non-HRI text designed to support manual operations and to facilitate key entry in menu driven systems. It may be used to specify the text equivalent of the data elements represented in barcodes, and is comprised of data titles and data content. The data content SHOULD be at least 7 millimetres / 0.275 inches in height. If there is no other language agreed between trading partners, data titles must be printed in English. As an option left at the discretion of the labeller, a second language can be added. GS1 Application Identifiers are not included in the data content.

6.6.4.3 Data titles

Data titles are the standard abbreviated descriptions of element strings, used to support the manual interpretation of encoded data. Data titles SHOULD be used adjacent to all data fields included in the 'non-HRI text including data titles' building block. Data titles may also be used adjacent to barcodes and HRI.

All data titles are shown in section [3.2](#).

6.6.4.4 Free format

Free format information may be comprised of non-HRI text and graphics. The name and address of the sender and receiver are typical examples of non-HRI text. Company logos and instruction pictograms are examples of graphics. All non-HRI text included in the free format building block SHALL be clearly legible and no less than 3 millimetres / 0.118 inches high.

6.6.4.5 Label dimensions

The physical dimensions of the label are determined by the labeller, but the size of the label should be consistent with the data requirements of the label. Factors influencing label dimensions include the amount of data required, the content and X-dimension of the barcodes used, and the dimensions of the logistic unit to be labelled. The business requirements for most users of GS1 Logistics Labels are met by using one of following:

- A6 (105 mm x 148 mm), which is particularly suitable when only the SSCC, or the SSCC and limited additional data, is encoded.
- 4 x 6 inch, which is particularly suitable when only the SSCC, or the SSCC and limited additional data, is encoded.

-or-

- A5 (148 mm x 210 mm).
- 6 x 8 inch.

6.6.4.6 Label location

Label placement specifications are maintained in section [6.7](#).

6.6.5 Label examples

Figure 6.6.5-1. The basic label: an SSCC



Notes:

This example shows a label containing only an SSCC. Such labels can be applied at production time, but also during transport or receipt in case no label is present on the logistic unit.

Building blocks (top-down):

- Text with data titles: SSCC.
- Barcodes + HRI: AI (00).

Figure 6.6.5-2. Label with combined supplier and carrier information

Von/From Mustermann GmbH Herr Schmidt Hauptstr. 35 60100 Frankfurt Germany	An/To Edificio de Servicios Generales Ms Alicia Romero Calle Centella 18 08820 Barcelona Spain
SSCC 395011015300000011 ROUTE GINC 402621 950110153B01001 Dimensions / Weight: 80x20x20 cm / 50,0 kg Billing No.: 5020613963 69 01	
 (403)402621(401)950110153B01001	
 (00)395011015300000011	

Notes:

This example shows a pallet label that may be applied at the time of transport. Besides information on the logistic unit it contains information on the route and destination.

Building blocks (top-down):

- Free format: Von/From ; An/To.
- Text with data titles: SSCC; ROUTE; Dimensions / Weight; Billing No.
- Barcodes and HRI: AI (403); AI (401); AI (00).

Figure 6.6.5-3. Label with supplier and carrier segments



Notes:

This example shows a case label that may be applied at the time of transport. Besides the SSCC it contains information on the route and destination.

Segments and building blocks (top-down):

- Carrier Segment:
 - Free format: FROM ; TO.
 - Barcodes and HRI: SHIP TO POST.
- Text with data titles: CARRIER; B/L ; PRO.
- Supplier Segment:
 - Barcodes and HRI: SSSC; AI (00).

Figure 6.6.5-4. Label with supplier information

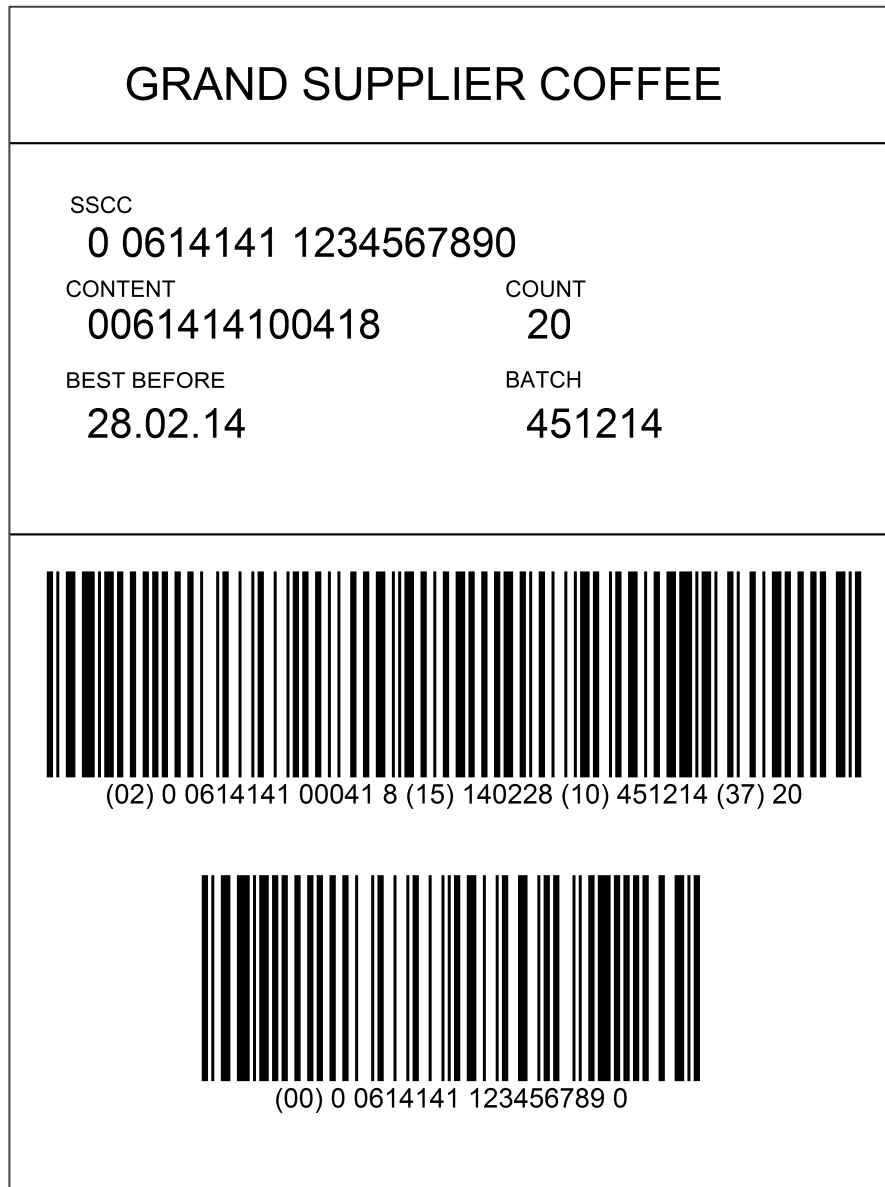

Notes:

This example shows a pallet label that may be applied at the time of production. It contains information on the supplier and the trade item, but no information on the transport and customer.

Building blocks (top-down):

- Free format: SUPPLIER NAME.
- Text with data titles: SSCC; CONTENT; COUNT; BEST BEFORE; BATCH.
- Barcodes and HRI: AI (02); AI (15); AI (10); AI (37); AI (00).

Figure 6.6.5-5. Label with supplier, customer, and carrier segments

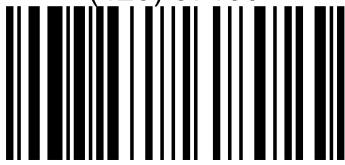
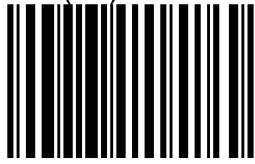
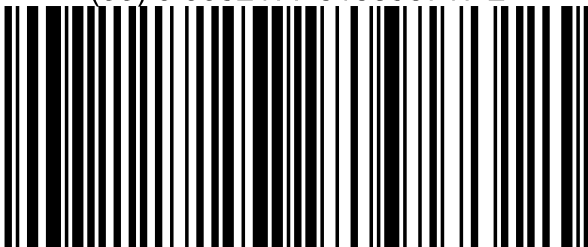
FROM Good Time Supplier 1155 Battery St San Fransisco CA 94111	TO Customer DC 1478 5241 San Antonio Dr Albuquerque, NM 87109
SHIP TO POST (420) 87109 	CARRIER Best Freight PRO: 2895769860 B/L: 853930
PO: 345-896779-0 DEPT: 092	
Store Number (90) 1528 	Customer Store 1528 1815 N Main Roswell NM 87109
SSCC (00) 0 0052177 513895717 2 	

Notes:

This example shows a case label that may be applied in a cross-docking scenario. Besides the SSCC it contains transport information and information on the final customer destination.

Segments and building blocks (top-down):

- Carrier segment:
 - Free format: FROM ; TO.
 - Barcodes and HRI: SHIP TO POST.
 - Text with data titles: Carrier ; B/L ; PRO.
- Customer segment:
 - Free format: PO ; DEPT.
 - Barcodes and HRI: Store Number.
 - Text with data titles: Customer.
- Supplier segment:
 - Barcodes and HRI: SSCC; AI (00).

6.7 Symbol placement used in general distribution

General distribution scanning items include any item handled as a single unit in the transport and distribution process. This definition covers a wide variety of package types, such as pallets, cartons, cases, bins, and totes. These items can be trade items and/or logistic units.

Barcode scanning may be carried out manually or automatically, and the recommended symbol location cannot be optimised for one or the other in an open supply chain scenario. These guidelines have been prepared with the objective to reduce overall supply chain cost but in the full knowledge that implementation will only be driven by a proven (supply chain) business-case.

6.7.1 General rule

The barcodes on units intended for general distribution SHALL be upright (i.e. in picket fence orientation) and placed on the sides of the unit. Each item SHALL have at least one barcode, and two are recommended when these symbols are pre-printed (see section [6.7.3](#)).

As not all products are packed in an identical way, this general rule may not apply to unusual packaging types (e.g., low height items, display cases, bags).

The barcodes SHALL be kept away from any vertical edges so that the barcodes are less likely to be accidentally damaged in transit.

6.7.1.1 Symbol placement on pallets

For all types of pallets, including full pallets containing individual trade items and single trade items, (such as a refrigerator or washing machine), the target height for the bottom of the barcode is between 400 millimetres (16 inches) and 800 millimetres (32 inches) from the base of the pallet. For pallet less than 400 millimetres (16 inches) high, the barcode SHALL be placed as high as possible while protecting the barcode.

The symbol including, its Quiet Zones, SHALL be at least 50 millimetres (2.0 inches) from any vertical edge to avoid damage.

Figure 6.7.1.1-1. Symbol placement on pallets

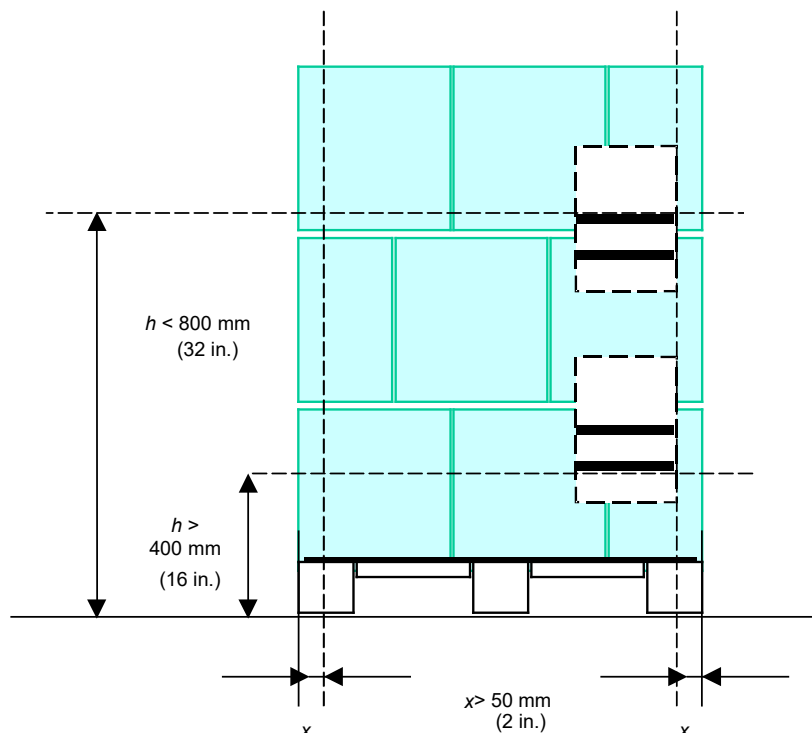

6.7.1.2 Symbol placement on cartons and outer cases

For cartons and outer cases, symbol placement will vary slightly in practice, however the target placement for the bottom of the barcode is 32 millimetres (1.25 inches) from the natural base of the item. The symbol including, its Quiet Zones, SHOULD be at least 19 millimetres (0.75 inch) from any vertical edge to avoid damage.

Figure 6.7.1.2-1. Symbol placement on cartons and outer cases

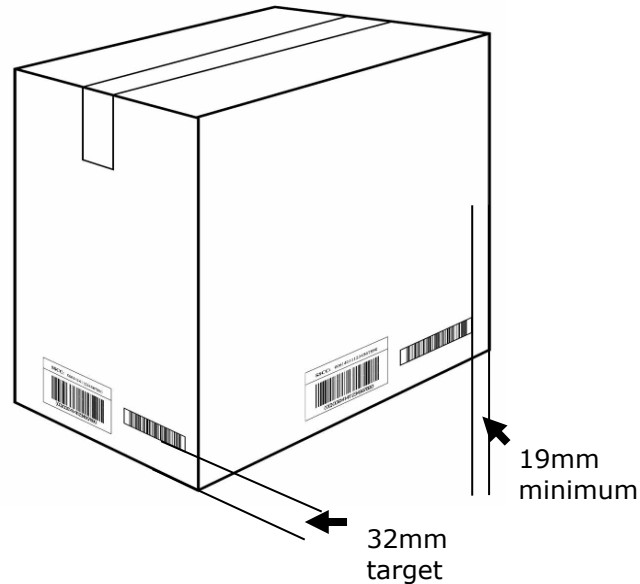

6.7.1.3 Symbol location on shallow trays and cases

If the height of a case or tray is less than 50 millimetres (2.0 inches), making it impossible to print a full height barcode with the human readable interpretation below the bars (see section [4.14](#) for HRI rules), or if the construction of the unit is such that the full symbol height cannot be accommodated, the following options SHALL be considered in this order of preference:

- Place the human readable interpretation adjacent to the symbol, outside the compulsory Quiet Zones.

Figure 6.7.1.3-1. Human readable interpretation to left of symbol

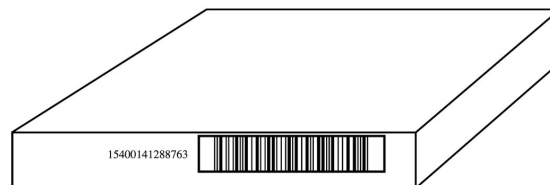

- When the height of the unit is less than 32 millimetres, the symbol may be placed on the top of the package. The symbol SHALL be placed with the bars perpendicular to the shortest side, no closer than 19 millimetres (0.75 inch) from any edge.

Figure 6.7.1.3-2.



Sometimes two barcodes are used on variable measure units. If it is necessary to remove the human readable interpretation from beneath the unit, the human readable interpretation of the main symbols SHALL be placed to the left of the bars of the main symbol. The human readable interpretation of the add-on symbol SHALL be placed to the right of the bars of the add-on symbol.

6.7.2 Recommendation to include a barcode on two sides

Although at least one side of all general distribution scanning items shall display the barcode information, it is recommended that two (or more) sides of the item carry a barcode with the exact same data when:

- The printing process makes this cost effective (e.g. pre-printed corrugated cartons).
- The supply chain requirement is that one symbol is always visible (e.g., pallets that are stored either long or short edge facing).

Figure 6.7.2-1. Two (or more) identical barcodes

Two identical labels improves scanning performance

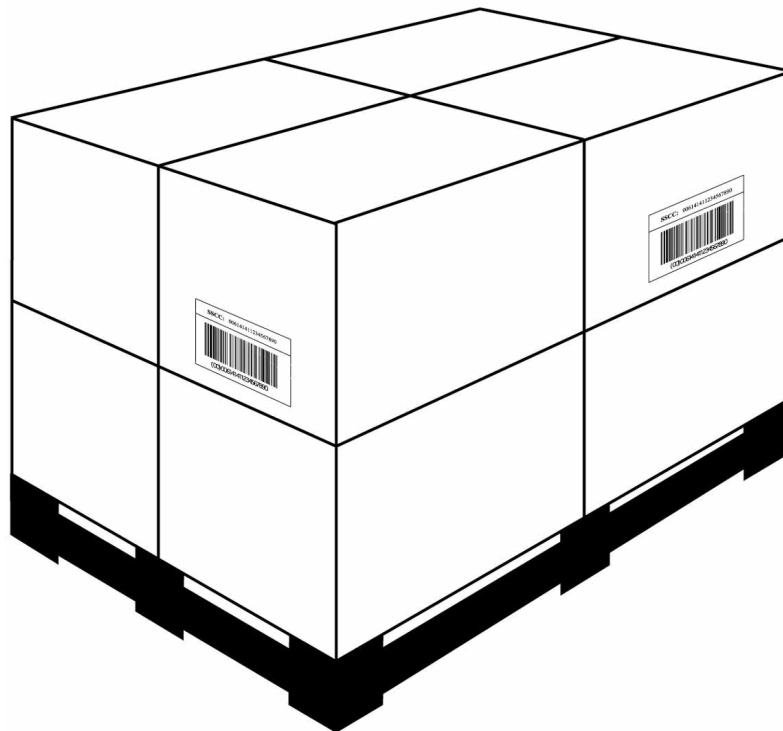

6.7.3 Add-on symbols

If the unit is already marked with a symbol, any add-on symbol SHALL be placed so as not to obscure the primary barcode. The preferred location for the symbol in this case is to the side of the primary barcode so that a consistent horizontal location is maintained. Maintain Quiet Zones for both symbols.

Figure 6.7.3-1. Placement of add-on symbols

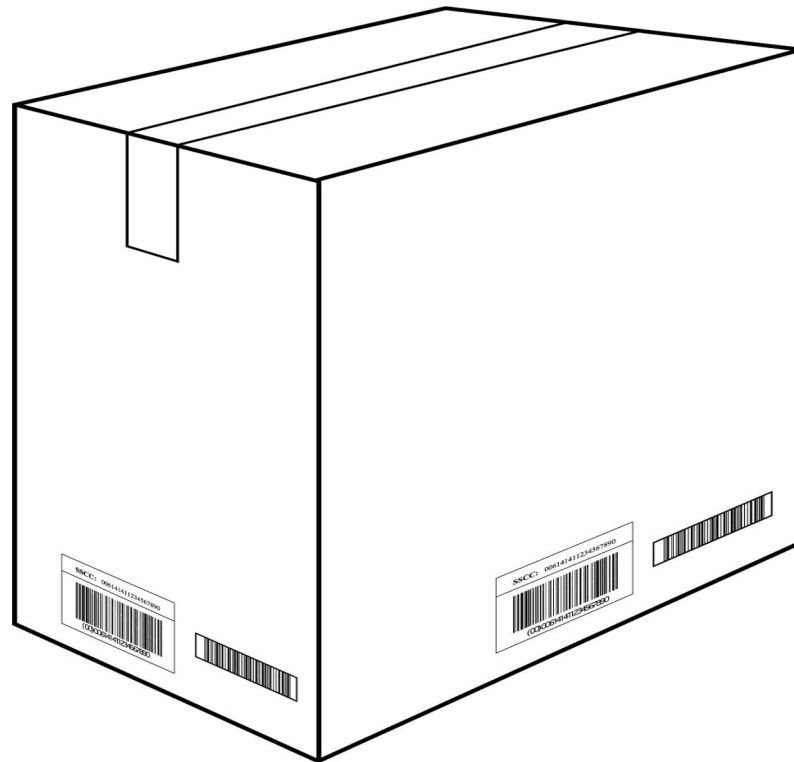

When it is possible for both parts of the data content to be represented in a GS1-128 barcode, concatenation into one symbol **MUST** be considered. Barcodes for general distribution scanning containing data essential for complete product identification (e.g., trade measurements) **SHALL** always be aligned with and to the right of the other barcode.

6.8 Symbol placement for regulated healthcare trade items

In addition to the general rules in section 6, the following symbol placement rules SHALL be added for regulated healthcare products.

6.8.1 Blister cells

Blister cells are pre-formed clear plastic bubbles, or blisters, containing a product.

6.8.1.1 Perforated blister cells

- Placement:
 - At the primary packaging level for pharmaceutical products packaged with perforated blister cells, a barcode SHALL be placed on each blister cell.

6.8.1.2 Non-perforated blister cells

- Placement:
 - At the primary packaging level for pharmaceutical products packaged with non-perforated blister cells, a barcode SHALL be placed once on the grouping of blister cells (e.g. blister card). The barcode may be placed anywhere on the blister card.
 - If random printing (e.g. no one to one correlation between printing impression and blister cell position) is used, the symbol may be placed multiple times to ensure that the symbol remains scannable until each blister has been used.

6.8.2 Products requiring variable data on primary and secondary packaging

Where such marking is feasible from a production and marking standpoint, the barcode carrying variable data (e.g. batch/lot number or expiry date) SHALL be marked on the primary and secondary packaging.

- Placement:
 - The barcode SHALL be placed only on one side of the packaging , which may be either the face, side or end panel.

7 AIDC validation rules

7.1	Introduction.....	412
7.2	Synopsis of message processing	413
7.3	Validation of the electronic message regarding system consistency	416
7.4	Validation of the electronic message regarding user requirements.....	417
7.5	Conversion of weights and measures in user applications	417
7.6	Linkage of GTINs in a database.....	419
7.7	Element strings represented in data carriers	421
7.8	Processing of data from a GS1 symbology using GS1 Application Identifiers	424
7.9	Check digit calculations.....	427
7.10	GTIN-12 and RCN-12 in a UPC-E barcode	429
7.11	The GS1 subset of international standard ISO/IEC 646	431
7.12	Determination of century in dates.....	433

7.1 Introduction

The purpose of entering data transmitted from a reading device into a system is to record a transaction. In the GS1 system, a transaction is an Electronic Message to be processed according to the meaning and content of the data fields contained in the message. This should be possible without requiring any human intervention to determine the data's meaning and content.

First, an item must be physically present in order to produce a barcode or RFID reader message about the item. Only the data present in the data carrier on the item, and therefore relevant to it, can be recorded.

The standardised element strings of the GS1 system are the basis for the identification of items of every kind. They identify a particular item in an unambiguous manner and supply relevant attribute information.

When these element strings are printed on items, the scanned and transmitted data refers to that item and identifies its physical presence at a given location. When the message read from the scanned data carrier is coupled with an internally assigned designation of the type of item movement (e.g., warehouse entry, stock taking, sales), it is possible to automatically record data related to each movement of items. This provides security in two ways. First, an item must be physically present in order to produce a barcode reader message about the item, and, second, only the data in the barcode on the item and, therefore, relevant to it, can be recorded. False notification of movements is thereby largely eliminated.

When element strings are used in administrative areas (e.g., in order entry) they also can be used for automatic, error-free data capture. Because of the considerable length of many GS1 system ID numbers, automatic reading has great significance. By using a check digit, a digit that ensures the data has been correctly composed, the accuracy of the reading is verified.

7.2 Synopsis of message processing

Figure 7.2-1. Synopsis of message processing

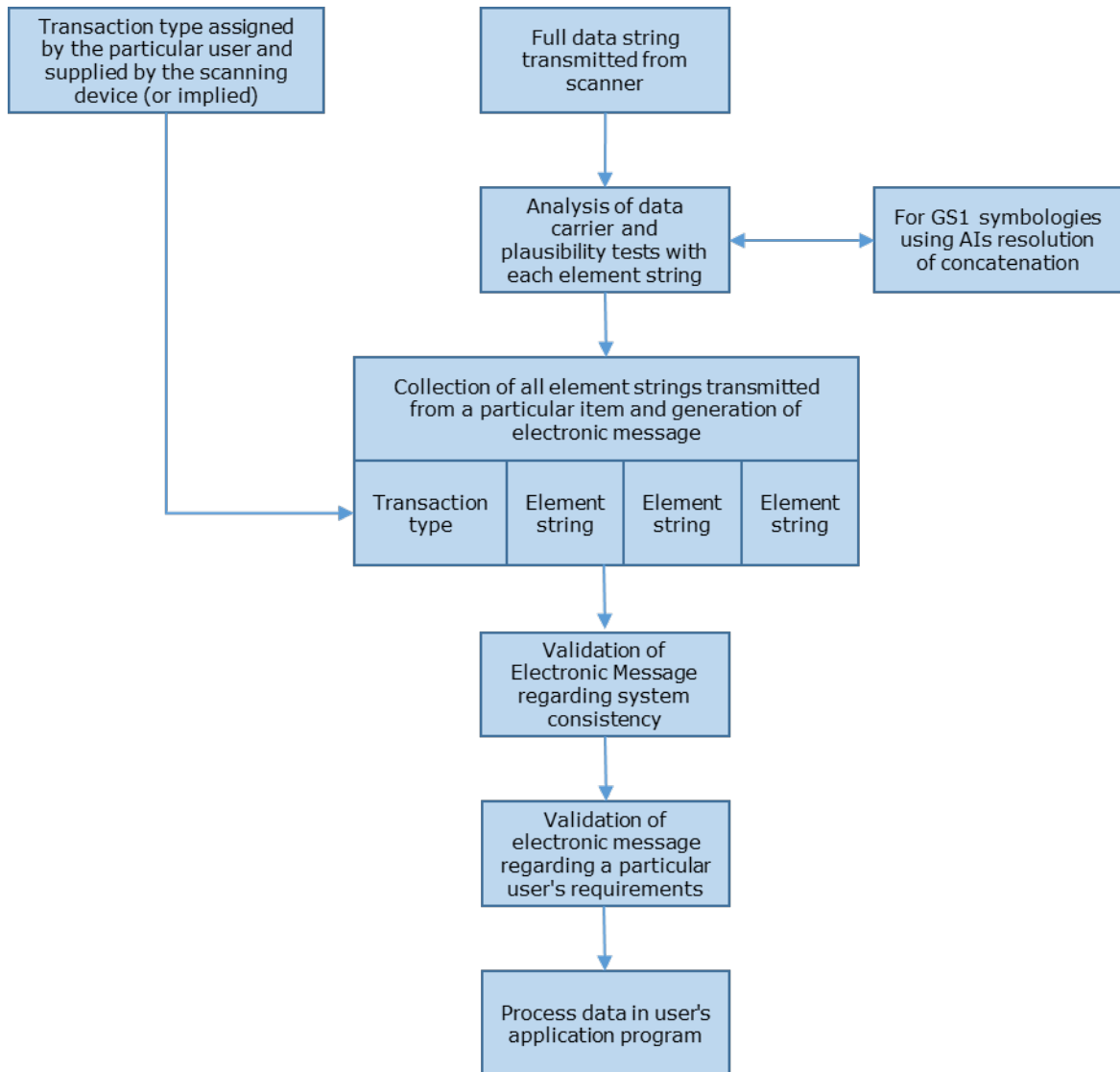

For details on any of the actions in figure 7.2-1, see the following subsections.

7.2.1 Analysis of the data carrier and plausibility test for element strings

Figure 7.2.1-1. Test procedure

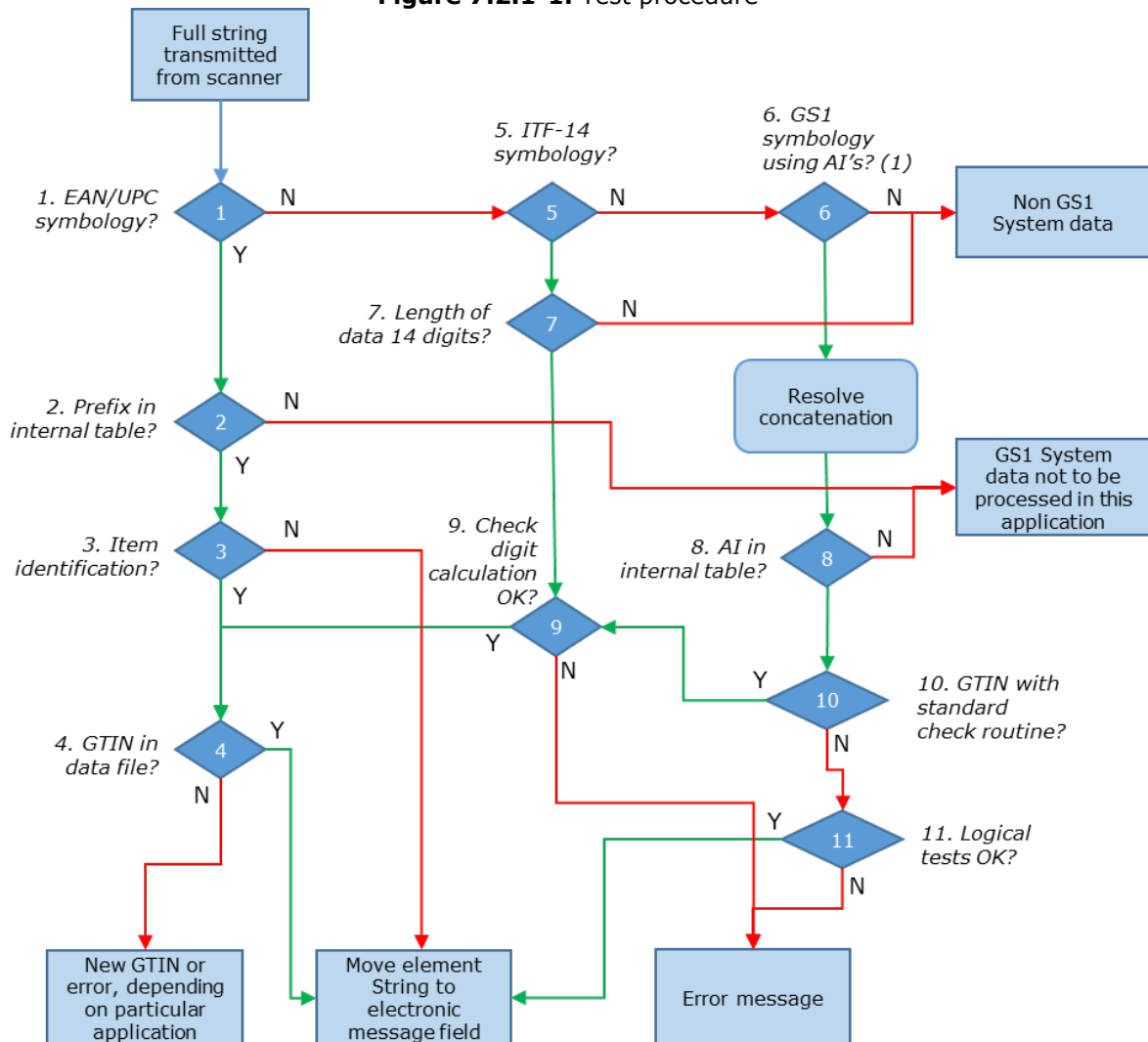

(1) GS1 symbologies that encode data using GS1 Application Identifiers include GS1-128, GS1 DataMatrix, GS1 QR Code, GS1 DataBar and Composite and are shown in 7.8. For further details on any of the actions in figure 7.2.1-1, see the sections 7.2.2, 7.2.3, 7.2.4, 7.2.5, 7.2.6, 7.2.7, and 7.2.8.

7.2.2 Symbology identification

Each transmitted full string consists of a symbology identifier and one or more element strings (see section 3). The identifiers of barcode symbologies are stated in section 5.

7.2.3 Prefix in internal table

System users may generate an internal table showing the GS1 Prefixes of element strings they wish to process. This table also serves to sort out the element strings representing item identification numbers in order to check their presence in the data file. Details on the respective prefixes are stated in section 3.

7.2.4 Item Identification

The symbols in the EAN/UPC symbology family contain identification data for trade items and special data structures (e.g., coupons). Whether an element string contains the identification of a trade item is determined by the GS1 Prefix. System users must determine the specific structure and meaning of prefixes 20 to 29 as defined by their GS1 Member Organisation.

7.2.5 GS1 Application Identifier (AI) in internal table

The element strings using GS1 Application Identifiers cover a wide range of applications. In order to keep the amount of programming on a reasonable level, it is possible to ignore processing of unwanted element strings. This is achieved by establishing an internal table with only the GS1 Application Identifiers intended for processing.

7.2.6 Length of Data 14 Digits

ITF-14 barcodes are used to represent trade item identification numbers. As the use of the general ITF symbology is not exclusive to the GS1 system a check to ensure the symbol encodes 14-digit reference field is recommended.

7.2.7 Check digit calculation and other system checks

In EAN/UPC symbology, the check digit verifies reading and decoding of barcodes as well as Global Trade Item Numbers (GTINs). This is performed automatically by the barcode reader.

Barcode readers processing ITF-14 symbols may be programmed to verify the GTIN's check digit as well. If this recommended verification has been performed, it is indicated by the symbology identifier]I1 (see section 5). For data transmitted from ITF-14 symbols with symbology identifier]I0, the GTIN's check digit SHALL be verified separately.

GS1-128 and GS1 DataBar have an integral symbol check character that verifies correct decoding of scanned data while GS1 DataMatrix and GS1 QR Code have a Reed Solomon error checking and correction feature. If an element string encoded in one of these symbol types includes a check digit, the check digit will not normally be verified by the barcode reader and SHALL be verified separately. While the data security provided by the symbol check character or error checking guarantees proper decoding of the entire element string, correctness of the contained identification number is achieved by having the application software verify the ID number's check digit. Other logical tests checks are recommended for reasonable data content, such as verifying:

- Data field ranges (e.g., month < 13 and > 00).
- The maximum length of a variable length element string.
- No alphanumeric characters in numeric only fields.
- Correct GS1 Prefixes.

7.2.8 Move element string to message field

Several element strings may be scanned in a single transaction. In order to verify the correctness and completeness of the transmitted data, each element string is transferred to a message record. If an element string does not include an GS1 Application Identifier, verification of the message is simplified if an GS1 Application Identifier is internally assigned. Global Trade Item Numbers (GTINs) that are carried by EAN-13, UPC-A, UPC-E or ITF-14 barcodes may be denoted with an internally assigned AI (01). Other element strings may be assigned "ghost" GS1 Application Identifiers.

7.3 Validation of the electronic message regarding system consistency

The GS1 system enables system users to process scanned data without human intervention. This implies that the electronic message generated from data scanned and transmitted from data carriers needs to substitute for all human activities during a particular transaction. In other words, the transmitted data must provide all information required for its correct processing.

The GS1 system is designed to fulfil these requirements. Section 4 describes the association of element strings to form valid messages.

Validation of system consistency refers to the verification of the correct composition of the electronic message by a system processing the transaction messages. Whether the message is adequate in business application terms is dealt with by the application software.

Only messages containing a valid set of element strings defined in the GS1 system can be unambiguously processed. The processing of invalid messages may lead to data file errors because the meaning and relationship of the element strings are not defined. This is illustrated in figures 7.3-1 and 7.3-2.

Figure 7.3-1. Examples of valid messages

Element strings in message			Comment
AI 00	AI 33nn		Identification of a logistic unit + logistic weight
AI 00	AI 01		Identification of an entity as a logistic unit and as a fixed measure trade item
AI 00	AI 01 '9'	AI 31nn	Identification of an entity as a logistic unit and as a variable measure trade item
AI 00	AI 02	AI 37	Identification of a logistic unit and its contained fixed measure trade items
AI 01	AI 10	AI 15	Identification of a trade item + lot number + best before date
AI 00	AI 401		Identification of a logistic unit as part of a consignment
AI 01 '9'	AI 31nn	AI 33nn	Identification of a variable measure trade item + logistic weight
AI 00	AI 01	AI 33nn	Identification of an entity as a logistic unit and a fixed measure trade item; the logistic weight is associated with the identification number of the logistic unit
AI 01	AI 710		Identification of a trade item + National Healthcare Reimbursement Number
AI 01	AI 711		Identification of a trade item + National Healthcare Reimbursement Number
AI 01	AI 712		Identification of a trade item + National Healthcare Reimbursement Number
AI 01	AI 713		Identification of a trade item + National Healthcare Reimbursement Number

Figure 7.3-2. Examples of invalid messages

Element strings in message			Comment
AI 00	AI 01	AI 37	Invalid identification of an entity as a logistic unit and as a fixed measure trade item; AI 37 (quantity of items contained) must be used with AI 02 only
AI 01	AI 10	AI 33nn	Invalid identification of a fixed measure trade item + lot number; AI 33nn is incorrect because logistic measures of a fixed measure trade item are fixed attributes stored in the data file
AI 01 '9'	AI 33nn		Invalid identification of a variable measure trade item + logistic weight; the mandatory Element String with a trade measure is missing
AI 00	AI 11		Invalid identification of a logistic unit; AI 11 is incorrect because a production date must be associated with the identification number of a trade item
AI 00	AI 01	AI 02/37	Invalid identification of an entity as a logistic unit and as a fixed measure trade item; AI 02/37 must not be associated with AI 01
AI 01	AI 30		Invalid identification of a fixed measure trade item; AI 30 must only be associated with the identification number of a variable measure trade item
AI 02	AI 37		Invalid identification of the fixed measure trade units contained in an unidentified logistic unit; AI 00 is missing
AI 00	AI 02		Invalid identification of a logistic unit and of the contained fixed measure trade items; AI 02 requires the mandatory presence of AI 37 to complete the identification of the content

7.4 Validation of the electronic message regarding user requirements

Some industry groups and organisations specify the use of particular element strings for attributes and other information not directly identifying the item. Contrary to the validation of messages for system conformity, GS1 does not define the rules for the validation and application of these particular element strings. Validation of messages containing these element strings in these environments (e.g., trade item identification with best before date and batch number) is left to the discretion of the particular system user community.

Validation of the correctness of a message may be performed differently for each Global Trade Item Number (GTIN), and instructions must be stored in the data file. System users should include the GS1 Application Identifiers and their specific application rules in the stored instructions.

Validation of the user requirements must be performed after validation of system consistency. Missing elements in consistent messages may be by-passed or completed in given instances. Inconsistent messages can never be processed properly.

7.5 Conversion of weights and measures in user applications

All weights and measures that are encoded in the element strings with the GS1 Application Identifiers (31nn) to (36nn) are structured according to the same mathematical rules. The determination of basic units of measurement and the freedom to choose the number of decimal positions will lead to variations in data representation. Suppliers will choose the value that best suits the respective trade item in terms of weight/size and the degree of accuracy required (e.g., grams) for the representation of weights and measures in the six-position data field.

The recipient of such goods also may want to store these details in a standardised form in his data file. This requirement is easily fulfilled through programming with the conversion formula shown below.

As described in section 3, in the GS1 Application Identifier position A_4 denotes the position of the implied decimal point, called the Inverse Exponent. The three-step formula to convert weights and measures is as follows:

1. Define the company's internal inverse exponent in accordance with the basic unit of measure of the company's internal field structure (e.g., for an AI expressing weight in kilograms, inverse exponent 0 could signify kilograms and inverse exponent 3 could signify grams).
2. Subtract the company's internal inverse exponent from the value of the position A_4 of the GS1 Application Identifier in the decoded element string. Call the result X.
3. Divide the amount of the six-digit applicable value field from the decoded data string by 10^X . The result is the value required in the company's data structure.

In the examples in figure 7.5-1, the company's system uses internal weight fields eight digits in length (format: **nnnnnnn.n**) with a unit of measure equal to grams. Thus, the company uses the internal inverse exponent of 3.

Figure 7.5-1. Conversion examples

Decoded data string				Conversion		Internal weight field								
GS1 Application Identifier A ₁ A ₂ A ₃ A ₄				Weight		Eight-digit data field defined as grams with one decimal position								
3	1	0	0	005097 (= 5097 kg)	Step 2: X = 0 minus 3 = -3 Step 3: 005097 divided by 10 ⁻³ (.001) =	5	0	9	7	0	0	0		
3	1	0	2	005097 (= 50.97 kg)	Step 2: X = 2 minus 3 = -1 Step 3: 005097 divided by 10 ⁻¹ (.1) =	0	0	5	0	9	7	0		
3	1	0	3	045250 (= 45.250 kg)	Step 2: X = 3 minus 3 = 0 Step 3: 045250 divided by 10 ⁰ (1) =	0	0	4	5	2	5	0		
3	1	0	4	012347 (= 1234.7 g)	Step 2: X = 4 minus 3 = 1 Step 3: 012347 divided by 10 ¹ (10) =	0	0	0	1	2	3	4	7	

↑
Decimal point

In the examples in figure 7.5-2, the company's system uses internal weight fields eight digits in length (format: **nnnnn.nnn**) with a unit of measure equal to kilograms. Thus the company uses an internal inverse exponent of 0

Figure 7.5-2. Conversion examples

Decoded data string				Conversion		Internal weight field								
GS1 Application Identifier A ₁ A ₂ A ₃ A ₄				Weight		Eight-digit data field defined as kilograms with three decimal position								
3	1	0	0	005097 (= 5097 kg)	Step 2: X = 0 minus 0 = 0 Step 3: 005097 divided by 10 ⁰ (1) =	0	5	0	9	7				
3	1	0	2	005097 (= 50.97 kg)	Step 2: X = 2 minus 0 = 2 Step 3: 005097 divided by 10 ² (100) =	0	0	0	5	0	9	7		
3	1	0	3	045250 (= 45.250 kg)	Step 2: X = 3 minus 0 = 3 Step 3: 045250 divided by 10 ³ (1000) =	0	0	0	4	5	2	5		
3	1	0	4	012347 (= 1234.7 g)	Step 2: X = 4 minus 0 = 4 Step 3: 012347 divided by 10 ⁴ (10000) =	0	0	0	0	1	2	3	5	

↑ ↑
Decimal Position
point rounde

7.6 Linkage of GTINs in a database

A trade item is any item (product or service) upon which there is a need to retrieve predefined information and that may be priced, or ordered, or invoiced at any point in any supply chain. Trade items may be a single item, part, unit, product, or service, or a predefined multiple or grouping or combination of such items. A separate Global Trade Item Number (GTIN) identifies each of these items unambiguously, irrespective of the applied data structure. This also applies to identification numbers for restricted distribution in a closed environment.

Information about the hierarchical structure of trade items is an important issue in a business. Section [7.7.1](#) illustrates an example of how the required links can be established by using a relational database.

7.6.1 The principle

The hierarchy for the example in figure 7.6.1-1 is basic product = A; 10 x A = product B; 5 x B = product C.

Figure 7.6.1-1. Example of GTIN linkage in database

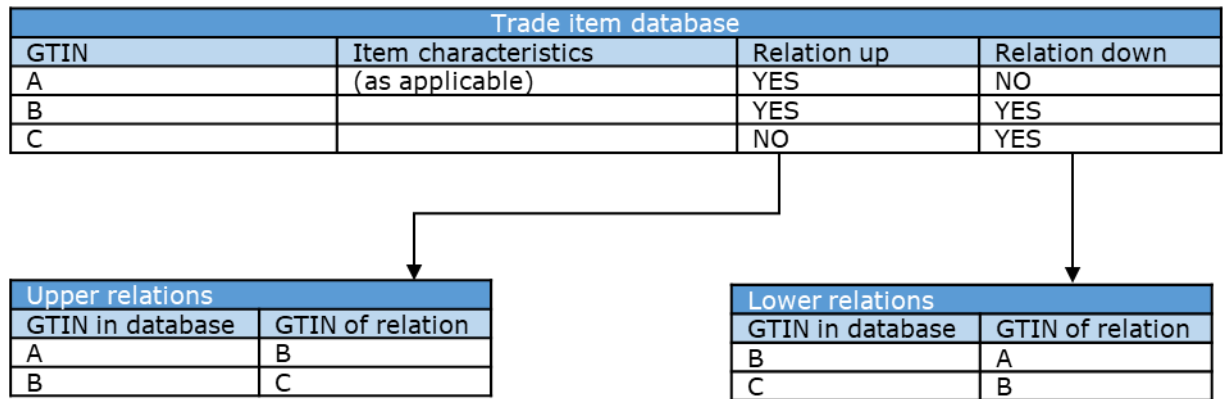

See figure 7.6.2-1 for the mechanism of linkage for the various types of trade items.

7.6.2 Extended example of a trade item hierarchy

Figure 7.6.2-1. Extended example of trade item hierarchy

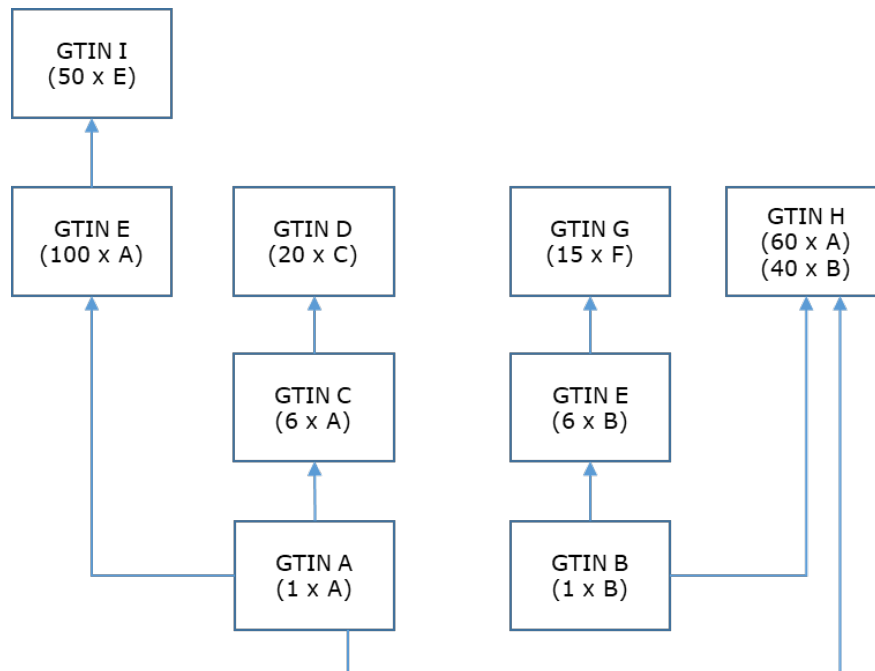

Note: For reasons of simplicity, Global Trade Item Numbers (GTINs) are expressed in letters in this example, signifying that they may be of any standardised structure.

Figure 7.6.2-2. Example of GTIN linkage in database

Trade item database			
GTIN	Item characteristics	Relation up	Relation down
A	(as applicable)	YES	NO
B		YES	NO
C		YES	YES
D		NO	YES
E		YES	YES
F		YES	YES
G		NO	YES
H		NO	YES
I		NO	YES

Upper relations			
GTIN in database	GTIN of relation	Quantity of items contained	Relation is mixed trade item
A	C	6*	No
A	E	100	No
A	H	60	Yes
B	F	6	No
B	H	40	Yes
C	D	20	No
E	I	50	No
F	G	15	No

Lower relations			
GTIN in database	GTIN of relation	Quantity of items contained	Relation is mixed trade item
C	A	6*	No
D	C	20	No
E	A	100	No
F	B	6	No
G	F	15	No
H	A	60	No
H	B	40	No
I	E	50	No

* Quantity of items numbered A contained in item C

- 
Note: The columns "GTIN in database" and "GTIN of relation" are sufficient to establish the links between the different items. The column "Quantity of items contained" provides additional information, which may be useful in particular business applications. The column "Relation is mixed trade item" provides the relations pointing to all trade items contained in a mixed trade item.

7.6.3 Linkage of GTINs in a non-relational database by trade item manufacturer

Many types of items are produced and distributed in fixed measure nested packaging configurations (e.g., consumer unit, carton, case, pallet) with fixed quantity relationships. The various packaging configurations are often broken into lower levels at various points in the supply chain, and, therefore, each level of the packaging may be a trade item. Computer systems must be capable of understanding the relationships of the units or trade items in the configuration and treating inventory of all levels of the configuration as one SKU (stock keeping unit).

The first digit indicator (values 1 to 8) of the GTIN-14 data structure can be used to identify levels of a packaging configuration. This allows digits 2 to 13 to remain constant for all levels of the packaging configurations for an item. If this method of numbering item configurations is used when necessary to support business processes or when driven by system constraints, the non-relational database construct defined below may be appropriate.

The item database is constructed with a base item record (table) and segments (tables) for each level of the item packaging configuration. Properly designed, this type of system can support pricing, ordering, and shipping of any level of the packaging configuration (trade item) with appropriate dimension and weight information. It enables inventories to be maintained by packaging level and in total for the base item. It also provides channel partners or customers the choice of ordering and invoicing units. Meeting these requirements often makes this approach a good business solution for manufacturers, because it meets the most critical needs in the supply chain and is practical to implement, particularly in distributed and small systems where performance is critical.

Using the GTIN-14 data structure, the base item record contains the base GTIN-8, GTIN-12, or GTIN-13 ID Number (digits 2 to 13) as a key, with all information relating to the base unit and the item in total (including total inventory balance). Each of the packaging segments contains information unique to the respective packaging configuration (e.g., indicator, check digit, quantity relationship to next lower level of the configuration, dimensions, weight, prices). After accessing the item record using the GTIN of the base item (digits 2 to 13), the packaging segments are accessed using the indicator (first digit). This construct demands that:

- The trade item must be fixed in measure.
- There must be a single Global Trade Item Number (GTIN) for the base item of the related packaging configurations that is a GTIN-8, GTIN-12, or GTIN-13.
- Each related packaging configuration is limited to eight levels of packaging for the base item using indicator values 1 to 8.

When storing GTIN-8s, GTIN-12s, or GTIN-13s in a 14-digit reference field or 14-digit data carrier, they must be stored based on rules that ensure their uniqueness.

Companies that receive trade items with GTINs must be able to process the complete GTIN without regard to how it was constructed.

7.7 Element strings represented in data carriers

Scanned element strings are decoded as a full string by the reading device and are then transmitted for processing in the application software. The full string is composed of a symbology identifier and one or more element strings. The meaning of an element string is also determined by the data carrier in which it is represented.

A synopsis by data carrier of the element strings described in these specifications is shown in figure 7.7.1-1, which also provides an overview of the sequential number range of trade items by data carrier.

7.7.1 Element strings represented in GS1 system data carriers

Figure 7.7.1-1. Element strings by data carrier

		ITF-14 or GS1-128 barcode																
		EAN-13 barcode																
		UPC-A or UPC-E barcode																
								EAN-8 barcode										
2.	*	*	*	*	*	*	*	0	0	0	0	0	0	0	0	0	0	C
								0	9	9	9	9	9	9	9	9	9	C
1.	*	*	*	*	*	*	*	1	0	0	0	0	0	0	0	0	0	C
								1	3	9	9	9	9	9	9	9	9	C
2.	*	*	*	*	*	*	*	2	0	0	0	0	0	0	0	0	0	C
								2	9	9	9	9	9	9	9	9	9	C
1.	*	*	*	*	*	*	*	3	0	0	0	0	0	0	0	0	0	C
								9	6	9	9	9	9	9	9	9	9	C
1.	0	0	0	0	0	1	0	0	0	0	0	0	0	0	0	0	0	C
	0	0	0	0	0	9	9	9	9	9	9	9	9	9	9	9	9	C
2.	*	*	0	0	1	0	0	0	0	0	0	0	0	0	0	0	0	C
			0	0	7	9	9	9	9	9	9	9	9	9	9	9	9	C
1.	0	0	0	0	8	0	0	0	0	0	0	0	0	0	0	0	0	C
	0	0	1	9	9	9	9	9	9	9	9	9	9	9	9	9	9	C
4.	*	0	2	0	0	0	0	0	0	0	0	0	0	0	0	0	0	C
	0	0	2	9	9	9	9	9	9	9	9	9	9	9	9	9	9	C
1.	0	0	3	0	0	0	0	0	0	0	0	0	0	0	0	0	0	C
	0	0	3	9	9	9	9	9	9	9	9	9	9	9	9	9	9	C
2.	*	0	4	0	0	0	0	0	0	0	0	0	0	0	0	0	0	C
	0	0	4	9	9	9	9	9	9	9	9	9	9	9	9	9	9	C
5.	*	0	5	0	0	0	0	0	0	0	0	0	0	0	0	0	0	C
	0	0	5	9	9	9	9	9	9	9	9	9	9	9	9	9	9	C
1.	0	0	6	0	0	0	0	0	0	0	0	0	0	0	0	0	0	C
	0	0	9	9	9	9	9	9	9	9	9	9	9	9	9	9	9	C
1.	0	1	0	0	0	0	0	0	0	0	0	0	0	0	0	0	0	C
	0	1	3	9	9	9	9	9	9	9	9	9	9	9	9	9	9	C
2. 4.	*	2	0	0	0	0	0	0	0	0	0	0	0	0	0	0	0	C
	*	2	9	9	9	9	9	9	9	9	9	9	9	9	9	9	9	C
1.	0	3	0	0	0	0	0	0	0	0	0	0	0	0	0	0	0	C
	0	9	6	9	9	9	9	9	9	9	9	9	9	9	9	9	9	C
7.	*	9	7	7	0	0	0	0	0	0	0	0	0	0	0	0	0	C
		9	7	9	9	9	9	9	9	9	9	9	9	9	9	9	9	C
8.	*	9	7	8	0	0	0	0	0	0	0	0	0	0	0	0	0	C
	*	9	7	9	9	9	9	9	9	9	9	9	9	9	9	9	9	C
5. 6.	*	9	8	0	0	0	0	0	0	0	0	0	0	0	0	0	0	C
		9	8	2	9	9	9	9	9	9	9	9	9	9	9	9	9	C
5.	*	9	9	0	0	0	0	0	0	0	0	0	0	0	0	0	0	C
		9	9	9	9	9	9	9	9	9	9	9	9	9	9	9	9	C
1.	1	0	0	0	0	0	1	0	0	0	0	0	0	0	0	0	0	C
	8	0	0	0	0	0	1	3	9	9	9	9	9	9	9	9	9	C
1.	1	0	0	0	0	0	3	0	0	0	0	0	0	0	0	0	0	C
	8	0	0	0	0	0	9	6	9	9	9	9	9	9	9	9	9	C
1. 3.	1	0	0	0	0	1	0	0	0	0	0	0	0	0	0	0	0	C
	9	0	0	0	0	9	9	9	9	9	9	9	9	9	9	9	9	C
1. 3.	1	0	0	0	9	0	0	0	0	0	0	0	0	0	0	0	0	C
	9	0	1	9	9	9	9	9	9	9	9	9	9	9	9	9	9	C
1. 3.	1	0	3	0	0	0	0	0	0	0	0	0	0	0	0	0	0	C
	9	0	3	9	9	9	9	9	9	9	9	9	9	9	9	9	9	C
1. 3.	1	0	6	0	0	0	0	0	0	0	0	0	0	0	0	0	0	C
	9	0	9	9	9	9	9	9	9	9	9	9	9	9	9	9	9	C
1. 3.	1	1	0	0	0	0	0	0	0	0	0	0	0	0	0	0	0	C
	9	1	3	9	9	9	9	9	9	9	9	9	9	9	9	9	9	C
1. 3.	1	3	0	0	0	0	0	0	0	0	0	0	0	0	0	0	0	C
	9	9	6	9	9	9	9	9	9	9	9	9	9	9	9	9	9	C
8.	1	9	7	8	0	0	0	0	0	0	0	0	0	0	0	0	0	C
	8	9	7	9	9	9	9	9	9	9	9	9	9	9	9	9	9	C

1. Fixed measure; 2. Fixed measure restricted distribution; 3. Variable measure; 4. Variable measure restricted distribution (not a GTIN); 5. Coupons (not a GTIN); 6. Refund receipts (not a GTIN); 7. ISSN; 8. ISBN

7.7.2 Element strings represented in a GS1 symbology using GS1 Application Identifiers

The element strings encoded in any GS1 symbology that uses GS1 Application Identifiers (such as GS1-128, GS1 DataMatrix, GS1 DataBar, GS1 QR Code and GS1 Composite) are composed of one or more GS1 Application Identifiers and one or several data fields. The GS1 Application Identifier denotes the contents and structure of the respective data fields. Full details are contained in section 3.

7.8 Processing of data from a GS1 symbology using GS1 Application Identifiers

Figure 7.8-1. Data processing overview

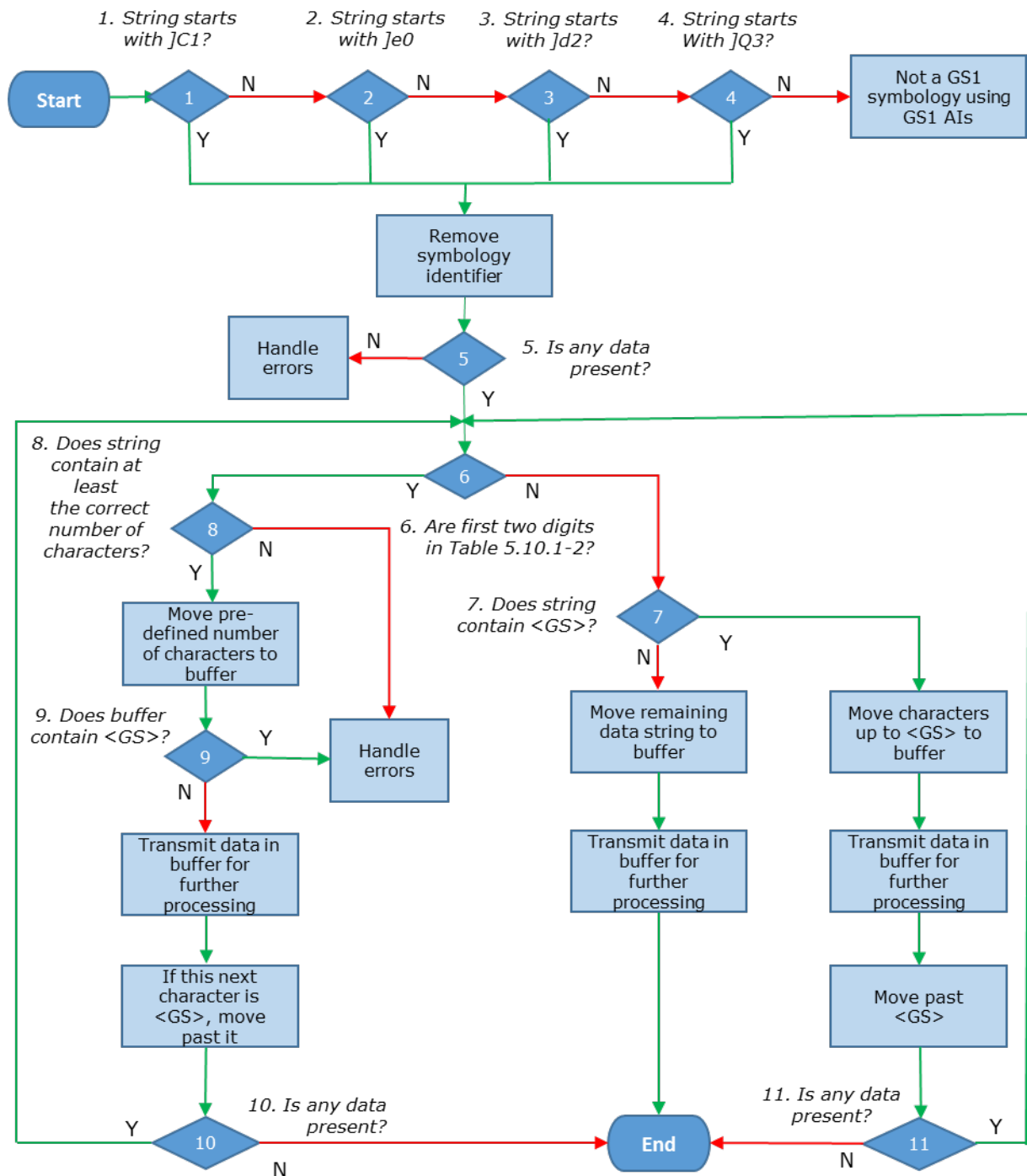

This system logic holds true for any GS1 symbology using GS1 Application Identifiers. The symbology identifiers listed in figure 7.8-1 are:

-]C1 = GS1-128.
-]e0 = GS1 DataBar and GS1 Composite symbols.
-]d2 = GS1 DataMatrix.
-]Q3 = GS1 QR Code.

7.8.1 General

Any GS1 symbology using GS1 Application Identifiers may represent several element strings in concatenated form (see section 5).

For processing as shown in figure 7.3-1, it is necessary to separate each element string, which is performed by the processing routine illustrated in figure 7.8-1.

7.8.2 Element strings with predefined lengths using GS1 Application Identifiers

Representation of more than one element string in a GS1 symbology using GS1 Application Identifiers may require the use of a separator character between the different element strings to mark their end.

However, in order to enable printing of smaller barcodes, some element strings have been predefined in length, so that their end is determined, and a separator character **SHOULD** not be used. These element strings are shown in the predefined table shown in section [5.10](#). All other element strings, even if defined as fixed length in section 3, are not of predefined length and are formally variable length fields which require a separator character if followed by another element string.

A separator character **SHOULD** not be used at the end of the last element string represented in a barcode or for certain AI combinations defined by the symbology specification (e.g., some types of GS1 DataBar).

7.8.3 The separator character and its value

In GS1-128 symbology: The Function 1 Symbol Character (FNC1) **SHOULD** be the separator character, and the control character <GS> (ASCII value 29 (decimal), 1D (hexadecimal)) may be an alternative.

In GS1 DataMatrix symbology: The Function 1 Symbol Character (FNC1) or the control character <GS> **SHALL** be the separator character.

In GS1 QR Code symbology: The control character <GS> or the character '%' (ASCII value 37 (decimal), 25 (hexadecimal)) **SHALL** be the separator character.

In GS1 DataBar and GS1 Composite symbology: The Function 1 Symbol Character (FNC1) **SHALL** be the separator character.

The value of the decoded separator character transmitted in the decoded data string is always control character <GS> (ASCII value 29 (decimal), 1D (hexadecimal)). It is important to note that some receiving systems may convert/interpret the control character <GS> as something other than ASCII value 29 (decimal), 1D (hexadecimal).

All element strings not included in the predefined table shown in section 5.10 **MUST** be separated by a separator character when followed by another element string in a single barcode.

7.8.4 National Healthcare Reimbursement Number (NHRN)

Some national or regional regulatory organisations may require pharmaceuticals and/or medical devices be identified with locally specific National Healthcare Reimbursement Numbers (NHRNs). For compliance with these national/regional regulatory or industry requirements where the GTIN does not meet current need, the trade item **SHALL** be identified with GTIN and AIs (710), (711), (712), and (713) National Healthcare Reimbursement Number.

One or more NHRNs may be associated with a single GTIN and encoded within the appropriate GS1 Data carrier in order to meet multiple market business needs. See figure 7.8.4-1 for examples of multiple NHRNs.

Additional individual NHRN AIs can only be assigned by GS1 and only in response to a work request being submitted into the GSMP system.

Figure 7.8.4-1. Examples of valid messages

Element strings in message					Comment
AI 01	AI 710				GTIN Identification of a trade item + Country "A" NHRN
AI 01	AI 710	AI 711			GTIN Identification of a trade item + Country "A" NHRN + Country "B" NHRN
AI 01	AI 710	AI 711	AI 712		GTIN Identification of a trade item + Country "A" NHRN + Country "B" NHRN + Country "C" NHRN
AI 01	AI 710	AI 711	AI 712	AI 713	GTIN Identification of a trade item + Country "A" NHRN + Country "B" NHRN + Country "C" NHRN + Country "D" NHRN

7.9 Check digit calculations

7.9.1 Standard check digit calculations for GS1 data structures

This algorithm is identical for all fixed length numeric GS1 data structures (including GDTI, GLN, GRAI, etc.) that require a check digit.

Figure 7.9.1-1. Check digit algorithm

Digit positions																		
GTIN-8											N ₁	N ₂	N ₃	N ₄	N ₅	N ₆	N ₇	N ₈
GTIN-12							N ₁	N ₂	N ₃	N ₄	N ₅	N ₆	N ₇	N ₈	N ₉	N ₁₀	N ₁₁	N ₁₂
GTIN-13						N ₁	N ₂	N ₃	N ₄	N ₅	N ₆	N ₇	N ₈	N ₉	N ₁₀	N ₁₁	N ₁₂	N ₁₃
GTIN-14					N ₁	N ₂	N ₃	N ₄	N ₅	N ₆	N ₇	N ₈	N ₉	N ₁₀	N ₁₁	N ₁₂	N ₁₃	N ₁₄
17 digits		N ₁	N ₂	N ₃	N ₄	N ₅	N ₆	N ₇	N ₈	N ₉	N ₁₀	N ₁₁	N ₁₂	N ₁₃	N ₁₄	N ₁₅	N ₁₆	N ₁₇
18 digits	N ₁	N ₂	N ₃	N ₄	N ₅	N ₆	N ₇	N ₈	N ₉	N ₁₀	N ₁₁	N ₁₂	N ₁₃	N ₁₄	N ₁₅	N ₁₆	N ₁₇	N ₁₈
Multiply value of each position by																		
	x3	x1	x3	x1	x3	x1	x3	x1	x3	x1	x3	x1	x3	x1	x3	x1	x3	
Accumulated results = sum																		
Subtract sum from nearest equal or higher multiple of ten = check digit →																		

Figure 7.9.1-2. Check digit calculation example

Example of a check digit calculation for the 18-digit field																		
Positions	N ₁	N ₂	N ₃	N ₄	N ₅	N ₆	N ₇	N ₈	N ₉	N ₁₀	N ₁₁	N ₁₂	N ₁₃	N ₁₄	N ₁₅	N ₁₆	N ₁₇	N ₁₈
Number without check digit	3	7	6	1	0	4	2	5	0	0	2	1	2	3	4	5	6	
Step 1: multiply by	x	x	x	x	x	x	x	x	x	x	x	x	x	x	x	x	x	
	3	1	3	1	3	1	3	1	3	1	3	1	3	1	3	1	3	
Step 2: add up results to sum	=	=	=	=	=	=	=	=	=	=	=	=	=	=	=	=	=	
	9	7	18	1	0	4	6	5	0	0	6	1	6	3	12	5	18	= 101
Step 3: Subtract sum from nearest equal or higher multiple of ten (110) = check digit (9)																		
Number with check digit	3	7	6	1	0	4	2	5	0	0	2	1	2	3	4	5	6	9

7.9.2 Check digit calculation for price/weight fields

To increase the security of reading a price or weight from a barcode, the check digit for these fields is not only calculated according to the methods described in the previous section, but also according to the procedure described in this section.

The basic principle of the check digit calculation is that each digit position in a price/weight field is assigned a weighting factor. Weighting factors are **2-**, **3**, **5+**, and **5-**. Each weighting factor affects the particular calculation for the position concerned. The result of such a calculation is called a weighted product. The figures that follow show the weighted products of the various weighting factors.

Figure 7.9.2-1. Weighting factor 2

Weighting factor 2										
Calculation rule: The digit is multiplied by 2. If the result has two digits, the tens digit is subtracted from the units digit. The units digit resulting is the weighted product.										
Digit	0	1	2	3	4	5	6	7	8	9
Weighted product	0	2	4	6	8	9	1	3	5	7

Figure 7.9.2-2. Weighting factor 3

Weighting factor 3										
Calculation rule: The digit is multiplied by 3. The unit's digit of the result is the weighted product.										
Digit	0	1	2	3	4	5	6	7	8	9
Weighted product	0	3	6	9	2	5	8	1	4	7

Figure 7.9.2-3. Weighting factor 5+

Weighting factor 5+										
Calculation rule: The digit is multiplied by 5. The units digit and the tens digit of the result are added together. The result of this sum is the weighted product.										
Digit	0	1	2	3	4	5	6	7	8	9
Weighted product	0	5	1	6	2	7	3	8	4	9

Figure 7.9.2-4. Weighting factor 5-

Weighting factor 5-										
Calculation rule: The digit is multiplied by 5. The tens digit of the result is subtracted from the result. The unit's digit of the result of this subtraction is the weighted product.										
Digit	0	1	2	3	4	5	6	7	8	9
Weighted product	0	5	9	4	8	3	7	2	6	1

7.9.3 Check digit calculation for the four-digit price field

Figure 7.9.3-1. Assigned weighting factors

Assigned weighting factors				
Digit position	1	2	3	4
Weighting factor	2-	2-	3	5-

- **Calculation step 1:** Determine the weighted product for each number in Positions One to Four according to the assigned weighting factors.
- **Calculation step 2:** Add the products of step 1.
- **Calculation step 3:** Multiply the result of step 2 by the factor 3. The unit's digit of the result is the check digit.

Figure 7.9.3-2. Example of a check digit calculation

Example of a check digit calculation					
Position of price field	1	2	3	4	
Assigned weighting factor	2-	2-	3	5-	
Amount	2	8	7	5	
Step 1: weighted product according to figure	4	5	1	3	
Step 2: sum	+	+	+	+	= 13
Step 3: multiply by 3					= 39 (*)
(*) Unit position is the check digit.					

7.9.4 Check digit calculation for the five-digit price field

Figure 7.9.4-1. Assigned weighting factors

Assigned weighting factors					
Digit positions	1	2	3	4	5
Weighting factor	5+	2-	5-	5+	2-

- **Calculation step 1:** Determine the weighted product for each number in Positions one to five according to the assigned weighting factors.
- **Calculation step 2:** Add the products of step 1.
- **Calculation step 3:** Subtract the result from the nearest equal or higher multiple of 10.
- **Calculation step 4:** Take the result and search for the same number in the weighted product row of figure 7.9.2-4. The check digit is the number in the digit row of the same column.

Figure 7.9.4-2. Example of a check digit calculation

Example of a check digit calculation						
Price field positions	1	2	3	4	5	
Assigned weighting factor	5+	2-	5-	5+	2-	
Amount	1	4	6	8	5	
Step 1: weighted product according to figure	5	8	7	4	9	
Step 2: sum	+	+	+	+	+	= 33
Step 3: result of subtraction (40 - 33)						= 7
Step 4: weighted product 7 in the figure weighting factor 5- shows number 6 to be the check digit.						

7.10 GTIN-12 and RCN-12 in a UPC-E barcode

Some of the GTIN-12 and RCN-12 number ranges beginning with the U.P.C. Prefix 0 may be represented in a small symbol called the UPC-E barcode (see section [2.1](#)).

The GTIN-12 or RCN-12 is condensed into a barcode consisting of six symbol character positions. For application processing, the GTIN-12 or RCN-12 must be transformed into its full length by the barcode reader software or by the application software. There is no six-digit UPC-E barcode.

It is possible to create false UPC-E barcodes if the encodation rules are not properly observed. Whether the digits represented in a UPC-E barcode can be expanded correctly to a GTIN-12 is verified by the following tests.

Test 1:

Verify the digits encoded in Positions 1 to 6 of the UPC-E barcode according to the diagram in figure 7.10-1.

Figure 7.10-1. Procedure for test 1

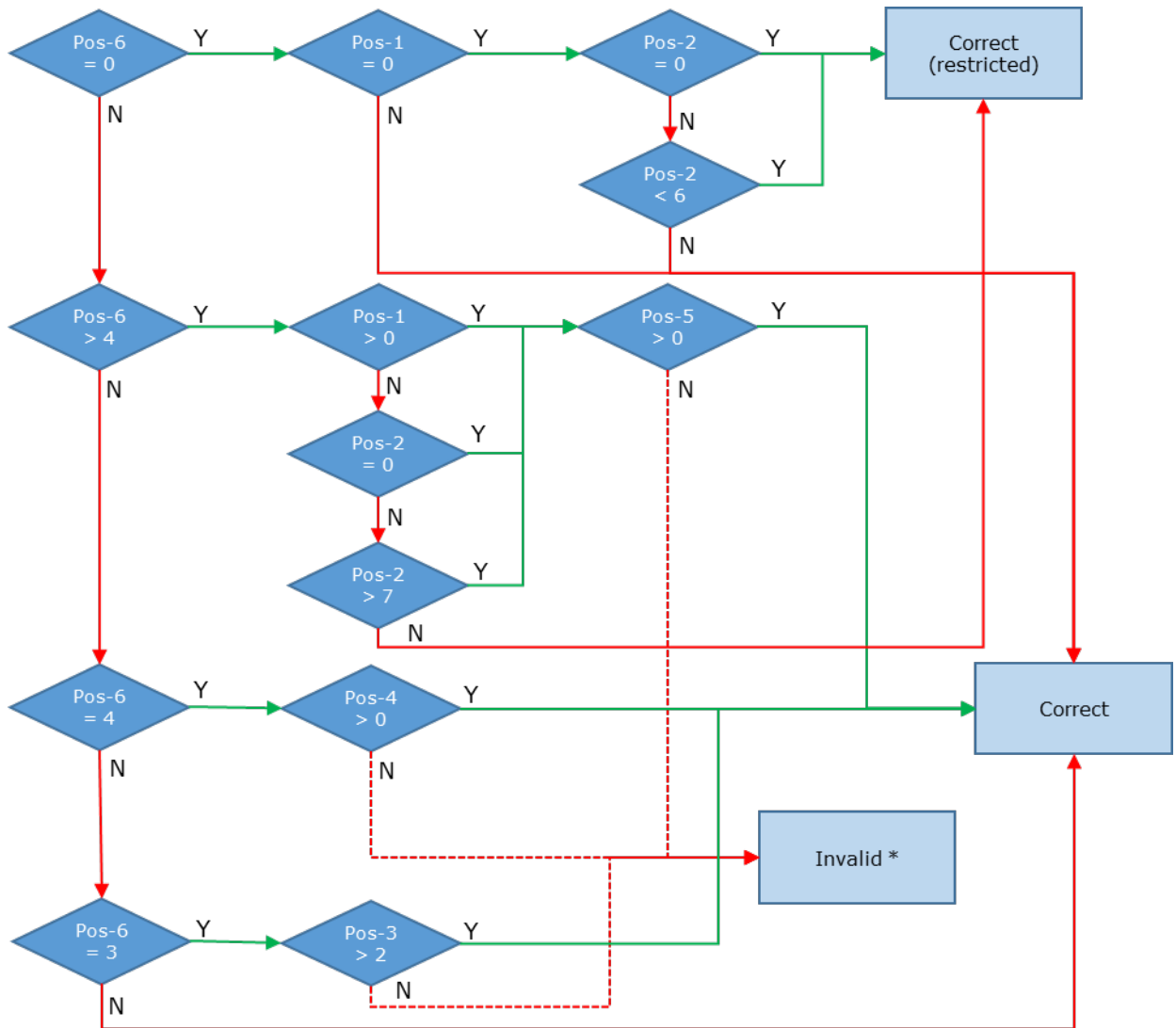

* These UPC-E barcodes were valid in previous specifications. Provision for accepting them must be made during decoding only.

Test 2:

Expand the digits encoded in the UPC-E barcode to the first 11 digits of the full length GTIN-12, calculate the check digit, and compare it with the check digit decoded from the UPC-E barcode. If they do not match, it signifies an invalid symbol.

7.11 The GS1 subset of international standard ISO/IEC 646

Figure 7.11-1 lists all characters allowed for use in GS1 Application Identifier (AI) element strings with the exception of the Component and Parts Identifier. Figure 7.11-1 corresponds to *ISO/IEC 646* Table 1. All other ISO 646 characters that are not listed here are not allowed in GS1 Application Identifier (AI) element strings. Figure 7.11-2 lists all the characters allowed for use in the GS1 Application Identifier for Component and Parts Identifier.

Figure 7.11-1. GS1 AI encodable character set 82

Graphic symbol	Name	Coded representation	Graphic symbol	Name	Coded representation
!	Exclamation mark	2/1	M	Capital letter M	4/13
"	Quotation mark	2/2	N	Capital letter N	4/14
%	Percent sign	2/5	O	Capital letter O	4/15
&	Ampersand	2/6	P	Capital letter P	5/0
'	Apostrophe	2/7	Q	Capital letter Q	5/1
(Left parenthesis	2/8	R	Capital letter R	5/2
)	Right parenthesis	2/9	S	Capital letter S	5/3
*	Asterisk	2/10	T	Capital letter T	5/4
+	Plus sign	2/11	U	Capital letter U	5/5
,	Comma	2/12	V	Capital letter V	5/6
-	Hyphen/Minus	2/13	W	Capital letter W	5/7
.	Full stop	2/14	X	Capital letter X	5/8
/	Solidus	2/15	Y	Capital letter Y	5/9
0	Digit zero	3/0	Z	Capital letter Z	5/10
1	Digit one	3/1	_	Low line	5/15
2	Digit two	3/2	a	Small letter a	6/1
3	Digit three	3/3	b	Small letter b	6/2
4	Digit four	3/4	c	Small letter c	6/3
5	Digit five	3/5	d	Small letter d	6/4
6	Digit six	3/6	e	Small letter e	6/5
7	Digit seven	3/7	f	Small letter f	6/6
8	Digit eight	3/8	g	Small letter g	6/7
9	Digit nine	3/9	h	Small letter h	6/8
:	Colon	3/10	i	Small letter i	6/9
;	Semicolon	3/11	j	Small letter j	6/10
<	Less-than sign	3/12	k	Small letter k	6/11
=	Equals sign	3/13	l	Small letter l	6/12
>	Greater-than sign	3/14	m	Small letter m	6/13
?	Question mark	3/15	n	Small letter n	6/14
A	Capital letter A	4/1	o	Small letter o	6/15
B	Capital letter B	4/2	p	Small letter p	7/0
C	Capital letter C	4/3	q	Small letter q	7/1
D	Capital letter D	4/4	r	Small letter r	7/2
E	Capital letter E	4/5	s	Small letter s	7/3
F	Capital letter F	4/6	t	Small letter t	7/4
G	Capital letter G	4/7	u	Small letter u	7/5
H	Capital letter H	4/8	v	Small letter v	7/6
I	Capital letter I	4/9	w	Small letter w	7/7

Graphic symbol	Name	Coded representation	Graphic symbol	Name	Coded representation
J	Capital letter J	4/10	x	Small letter x	7/8
K	Capital letter K	4/11	y	Small letter y	7/9
L	Capital letter L	4/12	z	Small letter z	7/10

Figure 7.11-2. GS1 AI encodable character set 39

Graphic symbol	Name	Coded representation	Graphic symbol	Name	Coded representation
#	Number Sign	2/3	H	Capital letter H	4/8
-	Hyphen/Minus	2/13	I	Capital letter I	4/9
/	Solidus	2/15	J	Capital letter J	4/10
0	Digit zero	3/0	K	Capital letter K	4/11
1	Digit one	3/1	L	Capital letter L	4/12
2	Digit two	3/2	M	Capital letter M	4/13
3	Digit three	3/3	N	Capital letter N	4/14
4	Digit four	3/4	O	Capital letter O	4/15
5	Digit five	3/5	P	Capital letter P	5/0
6	Digit six	3/6	Q	Capital letter Q	5/1
7	Digit seven	3/7	R	Capital letter R	5/2
8	Digit eight	3/8	S	Capital letter S	5/3
9	Digit nine	3/9	T	Capital letter T	5/4
A	Capital letter A	4/1	U	Capital letter U	5/5
B	Capital letter B	4/2	V	Capital letter V	5/6
C	Capital letter C	4/3	W	Capital letter W	5/7
D	Capital letter D	4/4	X	Capital letter X	5/8
E	Capital letter E	4/5	Y	Capital letter Y	5/9
F	Capital letter F	4/6	Z	Capital letter Z	5/10
G	Capital letter G	4/7	Intentionally left blank		

7.12 Determination of century in dates

Element strings are available for the following types of dates:

- Production date: AI (11).
- Due date: AI (12).
- Packaging date: AI (13).
- Best before date: AI (15).
- Sell by date: AI (16).
- Expiration date: AI (17).
- Expiration date and time: AI (7003).
- First freeze date: AI (7006).
- Harvest date: AI (7007).
- Date and time of production: AI (8008).

It is left to the discretion of the user to interpret a particular date type in the sense of his business practices. Such interpretation may change according to the product range for which a date is being applied.

Since the year data field consists of two positions, the century is established by following the procedure in the figure below.

Figure 7.12-1. Determination of century

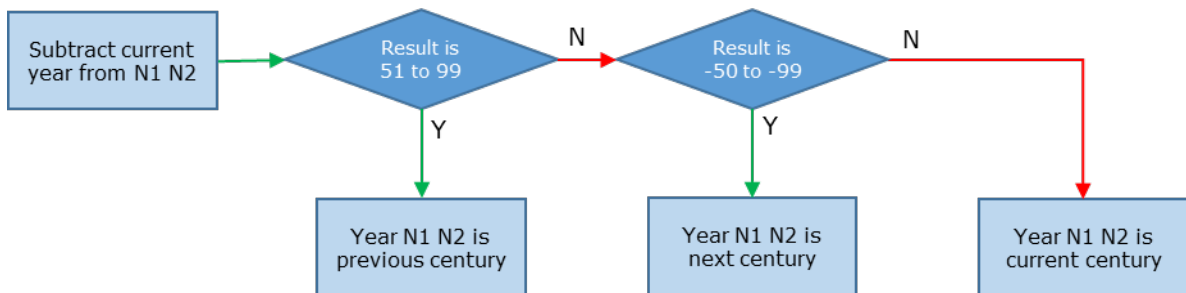

- ✔ **Note:** The element string can only specify a date in the range from 49 years in the past to 50 years in the future of the current year.

8 GS1 Standards glossary of terms

8.1	GS1 glossary of terms and definitions.....	435
8.2	GS1 abbreviations	445
8.3	Legacy (retired) terms	446

8.1 GS1 glossary of terms and definitions

The glossary lists the terms and definitions that are applied in this document. Please refer to the www.gs1.org/glossary for the online version.

Term	Definition
2-dimensional symbology	Optically readable symbols that must be examined both vertically and horizontally to read the entire message. Two-dimensional symbols may be one of two types: matrix symbols and multi-row symbols. Two-dimensional symbols have error detection and may include error correction features.
acceptance criteria	An allowance for a small measurement variation between commercial verifiers or operators during barcode verification testing.
active potency	Represents the measured actual ("Active") potency of a biologic such as haemophilia products.
add-on symbol	A barcode used to encode information supplementary to that in the main barcode.
adjacent symbols	Multiple barcodes placed next to one another without infringing on Quiet Zones.
allocation	The association of an issued GS1 Prefix, GS1 Company Prefix, or GS1 identification key with an entity or object in accordance with the GS1 rules and policies.
alphanumeric (an)	Describes a character set that contains alphabetic characters (letters), numeric digits (numbers), and other characters, such as punctuation marks.
aperture	A physical opening that is part of the optical path in a device such as a scanner, photometer, or camera. Most apertures are circular, but they may be rectangular or elliptical.
asset type	A component of the Global Returnable Asset Identifier (GRAI), assigned by the asset owner or manager, in order to create a unique GRAI.
attribute	An element string that provides additional information about an entity identified with a GS1 identification key, such as batch number associated with a Global Trade Item Number (GTIN).
autodiscrimination	The capability of a reader to automatically recognise and decode multiple barcode symbologies.
automatic identification and data capture (AIDC)	A technology used to automatically capture data. AIDC technologies include barcodes, smart cards, biometrics and RFID.
auxiliary patterns	Components of the EAN/UPC symbology. The centre guard bar pattern, the left guard bar pattern, and the right guard bar pattern are examples of these.
bar gain/loss	The increase/decrease in bar width due to effects of the reproduction and printing processes.
barcode	A symbol that encodes data into a machine readable pattern of adjacent, varying width, parallel, rectangular dark bars and pale spaces.
barcode verification	The assessment of the printed quality of a barcode based on ISO/IEC standards using ISO/IEC compliant barcode verifiers.
batch / lot	The batch or lot number associates an item with information the manufacturer considers relevant for traceability of the trade item. The data may refer to the trade item itself or to items contained in it.
bearer bars	Bar abutting the tops and bottoms of the bars in a barcode or a frame surrounding the entire symbol, intended to equalise the pressure exerted by the printing plate over the entire surface of the symbol and/or to prevent a short scan by the barcode reader.
brand owner	The organisation that owns the specifications of a trade item, regardless of where and by whom it is manufactured. The brand owner is normally responsible for the management of the Global Trade Item Number (GTIN).
carrier (logistics)	The party that provides freight transportation services or a physical or electronic mechanism that carries business information.
Character Set 39	The set of characters found in <i>ISO 646: Unique Graphic Character Allocations</i> which includes numeric, alphabetic upper-case, plus the characters "#", "-", and "/".
Character Set 82	The set of characters found in <i>ISO 646: Unique Graphic Character Allocations</i> which includes numeric, alphabetic upper-case and lower-case, plus twenty special characters but excluding "space".
check digit	A final digit calculated from the other digits of some GS1 identification keys. This digit is used to check that the data has been correctly composed. (See GS1 check digit calculation.)
component / part	An item that is intended to undergo at least one further transformation process to create finished goods for the purpose of downstream consumption

Term	Definition
Component / Part Identifier (CPID)	The unique identifier for a component / part, comprising a GS1 Company Prefix and a component / part reference
Composite Component	This term is used to refer to the 2D symbol component within a composite symbol.
Composite symbology	A GS1 system composite symbol consists of a linear component (encoding the item's primary identification) associated with an adjacent Composite Component (encoding attribute data, such as a batch number or expiration date). The composite symbol always includes a linear component so that the primary identification is readable by all scanning technologies, and so that imager scanners can use the linear component as a finder pattern for the adjacent 2D Composite Component. The composite symbol always includes one of three multi-row 2D Composite Component versions (e.g., CC-A, CC-B, CC-C) for compatibility with linear- and area-CCD scanners and with linear and rastering laser scanners.
concatenation	The representation of several element strings in one barcode.
configuration level	Assignment or grouping of trade items that includes one or more of the same trade item.
consignment	A grouping of logistic or transport units assembled by a freight forwarder or carrier to be transported under one transport document (e.g. waybill)
consumer product variant (CPV)	An alphanumeric attribute of a GTIN assigned to a retail consumer trade item variant for its lifetime.
country subdivision	Principle administrative divisions, or similar areas, of a country included in <i>ISO 3166-1</i> . Examples are a state in the US, a region in France, a canton in Swiss.
coupon	A voucher that can be redeemed at the point-of-sale for a cash value or free item.
Coupon Extended barcode	A supplemental barcode, used only in North America, that can be printed on a coupon to provide additional information, such as offer codes, expiration dates, and household identification numbers.
coupon instance ID	The identification of a unique instance of a digital coupon.
coupon issuer	Party issuing the coupons, bearing the commercial and financial responsibility for the coupons.
customer	The party that receives, buys, or consumes an item or service.
data character	A letter, digit, or other symbol represented in the data field(s) of an element string.
data field	A field that contains a GS1 identification key, an RCN, or attribute information
Data Matrix	A standalone, two-dimensional matrix symbology that is made up of square modules arranged within a perimeter finder pattern. Data Matrix ISO version ECC 200 is the only version that supports GS1 system identification numbers, including the Function 1 Symbol Character (FNC1). Data Matrix symbols are read by two-dimensional imaging scanners or vision systems.
data titles	Data titles are the abbreviated descriptions of element strings which are used to support manual interpretation of barcodes.
default front	The side of a retail consumer trade item that is used as the starting point to capture dimensional attributes for the purpose of data alignment.
digital coupon	A digital coupon is an electronic presentation, that is distributed and presented without manifesting as "paper" or in other hard-copy form, and that can be exchanged for a financial discount or for loyalty points when making a purchase.
direct mode	Mobile device information retrieval function when the barcode contains either the address (URL) of the content or service, or the content itself, in-line.
direct part marking (DPM)	Direct part marking refers to the process of marking a symbol on an item using an intrusive or non-intrusive method.
direct print	A process in which the printing apparatus prints the symbol by making physical contact with a substrate (e.g., flexography, ink jet, dot peening).
document type	A component of a Global Document Type Identifier (GDTI) assigned by the document issuer to create a unique GDTI.
dynamic assortment	An assortment that comprises a fixed count of a changing assortment of two or more different retail consumer trade items, each identified with a unique GTIN. All of the retail consumer trade items and their GTINs will have been communicated to the recipient before trading takes place and are declared on the package. The recipient has accepted that the supplier may change the assortment without any prior notice.
EAN/UPC Composite symbology family	A family of barcodes comprising the UPC-A Composite symbology, UPC-E Composite symbology, EAN-8 Composite symbology, and EAN-13 Composite symbology.

Term	Definition
EAN/UPC symbology	A family of barcodes including EAN-8, EAN-13, UPC-A, and UPC-E barcodes. Although UPC-E barcodes do not have a separate symbology identifier, they act like a separate symbology through the scanning application software. See also EAN-8 barcode, EAN-13 barcode, UPC-A barcode, and UPC-E barcode.
EAN-13 barcode	A barcode of the EAN/UPC symbology that encodes GTIN-13 or RCN-13.
EAN-8 barcode	A barcode of the EAN/UPC symbology that encodes GTIN-8 or RCN-8.
electronic commerce	The conduct of business communications and management through electronic methods, such as electronic data interchange (EDI) and automated data collection systems.
electronic message	A composition of element strings from scanned data and transaction information assembled for data validation and unambiguous processing in a user application.
Electronic Product Code (EPC)	An identification scheme for universally identifying physical objects (e.g. trade items, assets, and locations) via RFID tags and other means. The standardised EPC data consists of an EPC (or EPC Identifier) that uniquely identifies an individual object, as well as an optional filter value when judged to be necessary to enable effective and efficient reading of the EPC tags.
element	A single bar or space of a barcode.
element string	The combination of a GS1 Application Identifier and GS1 Application Identifier data field.
encounter	Situation on the uninterrupted course of which one or more healthcare provider or individual providers delivers healthcare services to a subject of care
enhanced level of AIDC marking (for regulated healthcare trade items)	A level within a graduated system of AIDC trade item marking that provides GTIN plus attribute information
episode of care	An encounter or series of encounters related to the detection and subsequent care for a particular healthcare requirement.
even parity	A characteristic of the encodation of a symbol character whereby the symbol character contains an even number of dark modules.
Extended Packaging	An approach to giving consumers access to additional information or services about trade items through their mobile device. It is the ability to retrieve additional information about the trade item through mobile devices or in general between link a trade item with virtual information or services.
extension digit	The first digit within the SSCC (Serial Shipping Container Code) which is allocated by the user and is designed to increase the capacity of the SSCC.
finished consumer trade item	A product after all production and packaging processes are completed and it is ready for distribution to the end consumer.
fixed length	Term used to describe a data field in an element string with an established number of characters.
fixed measure trade item	An item always produced in the same predefined version (e.g., type, size, weight, contents, design) that may be sold at any point in the supply chain.
freight forwarder	The party that arranges the carriage of goods including connected services and/or associated formalities on behalf of the shipper (consignor) or consignee.
fresh foods	Trade items in the following product categories: fruits, vegetables, meats, seafood, bakery and ready to serve food such as cheeses, cold cooked or cured meats, and salad, etc. Fresh foods are defined as food that is not preserved by canning, dehydration, freezing or smoking.
full string	The data transmitted by the barcode reader from reading a data carrier, including the symbology identifier as well as the encoded data.
Function 1 Symbol Character (FNC1)	A symbology character used in some GS1 data carriers for specific purposes.
general distribution scanning	Scanning environments that include barcoded trade items packaged for transport, logistic units, assets, and location tags.
general retail consumer trade item	A retail consumer trade item identified with a GTIN-13, GTIN-12 or GTIN-8 utilising omnidirectional linear barcodes that can be scanned by high-volume, omnidirectional scanners.
GINC	See Global Identification Number for Consignment.
GLN extension component	The GLN extension component is used to identify internal physical locations within a location which is identified with a GLN (stores, factories, buildings, etc.).
Global Coupon Number (GCN)	A GS1 identification key that provides a globally unique identification for a coupon, with an optional serial number

Term	Definition
Global Document Type Identifier (GDTI)	The GS1 identification key used to identify a document type. The key comprises a GS1 Company Prefix, document type, check digit, and optional serial number.
Global Electronic Party Information Registry (GEPIR®)	A web-browser interface and a machine to machine set of protocols for GS1 Member Organisation (MO) membership databases to communicate company information for selected GS1 keys including information about the allocation of the GS1 Company Prefixes used to create GS1 keys and/or individually assigned GS1 keys. Created in 1997 as a tool for MO staff, GEPIR's initial scope was to provide a search engine for member addresses and phone numbers using MO GS1 Company Prefix (GCP) databases as the source of information. In more recent versions, GEPIR also provides a very limited set of information on parties (GLNs) and trade items (GTINs).
Global Identification Number for Consignment (GINC)	The GS1 identification key used to identify a logical grouping of logistic or transport units that are assembled to be transported under one transport document (e.g. waybill). The key comprises a GS1 Company Prefix and the freight forwarder's or carrier's transport reference.
Global Individual Asset Identifier (GIAI)	The GS1 identification key used to identify an individual asset. The key comprises a GS1 Company Prefix and individual asset reference.
Global Location Number (GLN)	The GS1 identification key used to identify physical locations or parties. The key comprises a GS1 Company Prefix, location reference, and check digit.
Global Returnable Asset Identifier (GRAI)	The GS1 identification key used to identify returnable assets. The key comprises a GS1 Company Prefix, asset type, check digit, and optional serial number.
Global Service Relation Number (GSRN)	The Global Service Relation Number is the GS1 identification key used to identify the relationship between an organisation offering services and the recipient or provider of services. The key comprises a GS1 Company Prefix, service reference and check digit.
Global Shipment Identification Number (GSIN)	The GS1 identification key used to identify a logical grouping of logistic or transport units that are assembled by the consignor (seller) for a transport shipment from that consignor to one consignee (buyer) referencing a despatch advice and/or BOL. The key comprises a GS1 Company Prefix, shipper reference and check digit.
Global Trade Item Number® (GTIN®)	The GS1 identification key used to identify trade items. The key comprises a GS1 Company Prefix, an item reference and check digit.
GS1 AIDC data carrier	A means to represent data in a machine readable form; used to enable automatic reading of the element strings as specified for use by GS1.
GS1 Application Identifier	The field of two or more digits at the beginning of an element string that uniquely defines its format and meaning.
GS1 Application Identifier data field	The data used in a business application defined by one GS1 Application Identifier.
GS1 B2C Trusted Source of Data (TSD)	A GS1 managed network concept that leverages GTIN (product identification) and GDSN (product information) and would support the communication of authentic product data provided by brand owners to retailers, internet application providers, government, and consumers and shoppers using internet and mobile devices (phones, laptops, etc.).
GS1 check digit calculation	An algorithm used by the GS1 system for the calculation of a check digit to verify accuracy of data. (e.g., modulo 10 check digit, price check digit).
GS1 Common Currency Coupon Code	An identification number for coupons issued in a common currency area (e.g., the euro currency) that uses the Coupon Code-13 data structure.
GS1 Company Prefix	A unique string of four to twelve digits used to issue GS1 identification keys. The first digits are a valid GS1 Prefix and the length must be at least one longer than the length of the GS1 Prefix. The GS1 Company Prefix is issued by a GS1 Member Organisation. As the GS1 Company Prefix varies in length, the issuance of a GS1 Company Prefix excludes all longer strings that start with the same digits from being issued as GS1 Company Prefixes. See also U.P.C Company Prefix.
GS1 Company Prefix licensee	The entity to which a GS1 Company Prefix is licenced.
GS1 DataBar Composite symbology family	A family of symbols comprising all the GS1 DataBar barcodes when an accompanying Composite Component is printed directly above the linear component.
GS1 DataBar Expanded barcode	A barcode that encodes any GS1 identification key plus attribute data, such as weight and "best before" date, in a linear symbol that can be scanned omnidirectionally by suitably programmed point-of-sale scanners.
GS1 DataBar Expanded Stacked barcode	A barcode that is a variation of the GS1 DataBar Expanded barcode that is stacked in multiple rows and is used when the normal symbol would be too wide for the application.

Term	Definition
GS1 DataBar Limited barcode	A barcode that encodes a GTIN with a leading digit of zero or indicator digit of one in a linear symbol; for use on small items that will not be scanned at the point-of-sale.
GS1 DataBar Omnidirectional barcode	A barcode that encodes a GTIN. It is designed to be read by omnidirectional scanners.
GS1 DataBar Retail POS family	The members of the GS1 DataBar symbology family designed to be read in segments by omnidirectional scanners at retail POS: GS1 DataBar Omnidirectional; GS1 DataBar Stacked Omnidirectional; GS1 DataBar Expanded; GS1 DataBar Expanded Stacked.
GS1 DataBar Stacked barcode	A barcode that is a variation of the GS1 DataBar Truncated barcode that is stacked in two rows and is used when the GS1 DataBar Truncated barcode would be too wide for the application.
GS1 DataBar Stacked Omnidirectional barcode	A barcode that is a variation of the GS1 DataBar symbology that is stacked in two rows and is used when the GS1 DataBar Omnidirectional symbol would be too wide for the application. It is designed to be read by omnidirectional checkout scanners.
GS1 DataBar Truncated barcode	A barcode that is a truncated version of the GS1 DataBar Omnidirectional barcode. It is used when the GS1 DataBar Omnidirectional barcode would be too tall for small item marking applications. It is not intended for omnidirectional checkout scanning.
GS1 DataBar®	A family of barcodes, including GS1 DataBar Omnidirectional; GS1 DataBar Stacked Omnidirectional; GS1 DataBar Expanded; GS1 DataBar Expanded Stacked GS1 DataBar Truncated, GS1 DataBar Limited, and GS1 DataBar Stacked symbols.
GS1 DataMatrix	GS1 implementation specification for use of Data Matrix
GS1 EANCOM®	The GS1 standard for Electronic Data Interchange (EDI) that is a detailed implementation guideline of the UN/EDIFACT standard messages using the GS1 identification keys.
GS1 Global Data Dictionary	A repository tool used to record GS1 member standards agreements on business terms and definitions used by all business units.
GS1 Global Standards Management Process	GS1 created the Global Standards Management Process (GSMP) to support standards development activity for the GS1 system. The GSMP uses a global consensus process to develop supply chain standards that are based on business needs and user-input
GS1 identification key	A unique identifier for a class of objects (e.g. a trade item) or an instance of an object (e.g. a logistic unit).
GS1 identification key licensee	The entity to which a GS1 Identification Key is licenced.
GS1 Member Organisation	A member of GS1 that is responsible for administering the GS1 system in its country (or assigned area). This task includes, but is not restricted to, ensuring user companies make correct use of the GS1 system, have access to education, training, promotion and implementation support and have access to play an active role in GSMP.
GS1 Prefix	A unique string of two or more digits issued by GS1 Global Office and allocated to GS1 Member Organisations to issue GS1 Company Prefixes or allocated to other specific areas.
GS1 QR Code	GS1 implementation specification for use of QR Code
GS1 symbologies using GS1 Application Identifiers	All GS1 endorsed barcode symbologies that can encode more than a GTIN namely GS1-128, GS1 DataMatrix, GS1 DataBar and Composite.
GS1 system	The specifications, standards, and guidelines administered by GS1.
GS1 XML	The GS1 standard for extensible markup language (XML) schemas providing users with a global business messaging language of e-business to conduct efficient internet-based electronic commerce.
GS1®	Based in Brussels, Belgium, and Princeton, USA, it is the organisation that manages the GS1 system. Its members are GS1 Member Organisations.
GS1-128 symbology	A subset of Code 128 that is utilised exclusively for GS1 system data structures.
GS1-8 Prefix	A unique string of three digits issued by GS1 Global Office and allocated to GS1 Member Organisations to issue GTIN-8s or allocated to issue RCN-8s (see RCN-8).
GSIN	See Global Shipment Identification Number.
GTIN plus attribute(s) flag	A trigger in systems to determine if additional processing is required by a barcode user for a given GTIN.
GTIN-12	The 12-digit GS1 identification key composed of a U.P.C. Company Prefix, item reference, and check digit used to identify trade items.

Term	Definition
GTIN-13	The 13-digit GS1 identification key composed of a GS1 Company Prefix, item reference, and check digit used to identify trade items.
GTIN-14	The 14-digit GS1 identification key composed of an indicator digit (1-9), GS1 Company Prefix, item reference, and check digit used to identify trade items.
GTIN-8	The 8-digit GS1 identification key composed of a GS1-8 Prefix, item reference, and check digit used to identify trade items.
guard bar pattern	An auxiliary pattern of bars and spaces corresponding to start or stop patterns in barcode symbologies, and serving to separate the two halves of EAN-8, EAN-13, and UPC-A symbols.
healthcare primary packaging	The first level of packaging for the product marked with an AIDC data carrier either on the packaging or on a label affixed to the packaging. For non-sterile packaging, the first level of packaging can be the packaging in direct contact with the product. For sterile packaging, the first level of packaging can be any combination of the sterile packaging system, May consist of a single item or group of items for a single therapy such as a kit. For packaging configurations that include a retail consumer trade item, primary packaging is a packaging level below the retail consumer trade item.
healthcare provider	An organisation or facility that delivers healthcare to a subject of care. Corresponds to "care delivery organisation", "healthcare organisation", etc.
healthcare secondary packaging	A level of packaging marked with an AIDC carrier that may contain one or more primary packages or a group of primary packages containing a single item.
highest level of AIDC marking (for regulated healthcare trade items)	A level within a graduated system of AIDC trade item marking that provides GTIN, serialisation, and potentially other attribute information.
House Waybill Number	A freight forwarder's document used mainly as a control for the goods within the freight forwarder's own service system.
human readable interpretation(HRI)	Characters, such as letters and numbers, which can be read by persons and are encoded in GS1 AIDC data carriers confined to a GS1 standard structure and format. The human readable interpretation is a one-to-one illustration of the encoded data. However start, stop, shift and function characters, as well as the symbol check character, are not shown in the human readable interpretation.
identification number	A numeric or alphanumeric field intended to enable the recognition of one entity versus another.
indicator	A digit from 1 to 9 in the leftmost position of the GTIN-14.
indirect mode	Mobile device information retrieval function when the code contains an identifier, which needs to be resolved to obtain the content or service. Resolving an identifier means looking it up, typically at a network service, to determine the corresponding content or service.
individual asset	An entity that is part of the inventory of assets for a given company. (See also returnable asset.)
individual asset reference	A component of the Global Individual Asset Identifier (GIAI) assigned by the asset owner or manager to create a unique GIAI.
individual provider	Any person who provides or is a potential provider of a health care service to a subject of care
inner trade item grouping	Intermediate package of multiples of the same trade item or a predefined assortment of trade items. An inner trade item grouping may or may not be sold at POS. (In some regions may also be referred to as inner pack).
Interleaved 2-of-5 symbology	Barcode symbology used for the ITF-14 barcode.
inverse exponent	The GS1 Application Identifier digit that denotes the implied decimal point position in an element string.
issuance	The generation of a GS1 Prefix, GS1 Company Prefix, or GS1 identification key in accordance with GS1 rules and policies.
item reference	A component of the Global Trade Item Number (GTIN) assigned by the brand owner to create a unique GTIN.
ITF symbology	See Interleaved 2-of-5 symbology.
ITF-14 barcode	ITF-14 (a subset of Interleaved 2-of-5) barcodes carry GTINs only on trade items that are not expected to pass through the point-of-sale.
kit	A collection of different regulated healthcare items assembled for use in a single therapy.

Term	Definition
leading zero(s)	Digits (always zeroes) which must be placed in the leftmost position(s) of a data string when GTIN-8, GTIN-12, or GTIN-13 are encoded in an GS1 AIDC data carrier that requires 14-digits or when used for the same intent in other data structures such as GRAI.
levels of AIDC marking	A graduated system of AIDC marking. The graduated system is defined as minimum, enhanced and highest levels of AIDC marking.
linear barcode	Barcode symbology using bars and spaces in one dimension.
local assigned code (LAC)	A particular use of the UPC-E barcode for restricted distribution.
location reference	A component of a Global Location Number (GLN) assigned by the party that defined the location to create a unique GLN.
logistic measures	Measures indicating the outside dimensions, total weight, or volume inclusive of packing material of a logistic unit. Also known as gross measures.
logistic unit	An item of any composition established for transport and/or storage that needs to be managed through the supply chain. It is identified with an SSCC.
loose produce	Fruits and vegetables which are delivered to the store loose, in boxes or cases, and then put into a bag or selected individually by the customer for purchase.
magnification	Different sizes of barcodes based on a nominal size and a fixed aspect ratio; stated as a percentage or decimal equivalent of a nominal size.
measure verifier digit	A digit calculated from the measure field in a Restricted Circulation Number (RCN) encoded using the EAN/UPC symbology. Used to check that the data has been correctly composed.
medical device	Any instrument, apparatus, implement, machine, appliance, implant, in vitro reagent or calibrator, software, material or other similar or related article, intended by the manufacturer to be used, alone or in combination, for human beings for any medical purpose.
minimum level of AIDC marking (for regulated healthcare trade items)	A level within a graduated system of AIDC trade item marking that provides GTIN with no attribute information.
module	The narrowest nominal width unit of measure in a barcode. In certain symbologies, element widths may be specified as multiples of one module. Equivalent to X-dimension.
modulo 10	The name of the algorithm – a simple checksum formula in the public domain – used to create a check digit for those GS1 identification keys that require one.
modulo 103 GS1-128 symbol check character	A number, which results from a modulo calculation, that is encoded in the GS1-128 barcode as a self-checking symbol character. It is created automatically by software as a symbol overhead character and is not expressed in the human readable interpretation.
multiple unit blister / package	Immediate package for a medicine with more than one single unit. Package which fully encloses the pill / caplet / capsule. Each dosage form may be individually packaged. The individually blistered dosage forms are attached to each other in one strip.
National Healthcare Reimbursement Number (NHRN)	National and/or regional identification numbers used on pharmaceutical and/or medical devices where required by national or regional regulatory organisations for product registration purposes and/or for the management of healthcare provider reimbursement.
National Trade Item Number (NTIN)	A coding scheme, administered in the healthcare sector by a national organisation for which a GS1 Prefix has been issued to permit its uniqueness within the GTIN pool but without assurance of full compatibility with GTIN functionality. The result is a product identification number assigned by a third party (not the brand owner or manufacturer). Example: the CIP (Club Inter Pharmaceutique) in France administered by the French Health Products Safety Agency (AFSSAPS).
natural base	The side of a non-retail consumer trade item package that is used as a reference point for capturing dimensional attributes for the purpose of data alignment.
non-HRI text	Characters such as letters and numbers that can be read by persons and may or may not be encoded in GS1 AIDC data carriers and are not confined to a structure and format based on GS1 standards (e.g., a date code expressed in a national format that could be used to encode a date field in a GS1 AIDC data carrier, brand owner name, consumer declarations).
odd parity	A characteristic of the encodation of a symbol character whereby the symbol character contains an odd number of dark modules.
omnidirectional linear barcode	A linear barcode symbol designed to be omnidirectionally read in segments by suitably programmed high-volume omnidirectional point-of-sale (POS) scanners.
packaging component	Entities such as bottles, caps, and labels to package a consumer trade item.

Term	Definition
packaging component number	GTIN attribute used to establish a relationship between a finished consumer trade item and packaging components.
payment slip	The end customer's notification of a demand for payment for a billable service (e.g., utility bill) comprising an amount payable and payment conditions.
point-of-care (POC)	Dispensing or use of a non-retail, regulated healthcare pharmaceutical or medical device to a patient based on right product, dose, and route of administration
point-of-sale (POS)	Refers to the retail checkout where omnidirectional barcodes must be used to enable very rapid scanning or low volume checkout where linear or 2D matrix barcodes are used with image-based scanners.
predefined assortments	An assortment that comprises a fixed count of two or more different trade items, each identified with a unique GTIN that is declared on the package. The trade items contained within the assortment may be trade items of one or more manufacturers. When an assortment contains items from multiple manufacturers the GTIN requirement for the assortment is the responsibility of the organisation that creates the assortment. Any change in the configuration of the assortment is considered a new trade item.
price check digit	A digit calculated from the price element in a Restricted Circulation Number (RCN) encoded using the EAN/UPC symbology. Used to check that the data has been correctly composed.
price verifier digit	See price check digit.
primary barcode	The barcode containing the identification number of the item (e.g. GTIN, SSCC). Used to determine the placement of any additional barcode information.
QR Code	A two-dimensional matrix symbology consisting of square modules arranged in a square pattern. The symbology is characterised by a unique finder pattern located at three corners of the symbol. QR Code symbols are read by two-dimensional imaging scanners or vision systems.
Quiet Zone	A clear space which precedes the start character of a barcode and follows the stop character. Formerly referred to as "clear area" or "light margin".
Quiet Zone Indicator	A greater than (>) or less than (<) character, printed in the human readable field of the barcode, with the tip aligned with the outer edge of the Quiet Zone.
radio frequency	Any frequency within the electromagnetic spectrum associated with radio wave propagation. When a radio frequency current is supplied to an antenna, an electromagnetic field is created that then is able to propagate through space. Many wireless technologies are based on radio frequency field propagation.
radio frequency identification (RFID)	A data carrier technology that transmits information via signals in the radio frequency portion of the electromagnetic spectrum. A radio frequency identification system consists of an antenna and a transceiver, which read the radio frequency and transfer the information to a processing device, and a transponder, or tag, which is an integrated circuit containing the radio frequency circuitry and information to be transmitted.
random assortment	An assortment that comprises items that are not uniquely identified on the package and are not marked for individual sale (e.g., a bag of individually wrapped candies or colours of tooth brushes).
RCN-12	A 12-digit Restricted Circulation Number (see Restricted Circulation Number).
RCN-13	A 13-digit Restricted Circulation Number (see Restricted Circulation Number).
RCN-8	An 8-digit Restricted Circulation Number (see Restricted Circulation Number)
refund receipt	A voucher produced by equipment handling empty containers (bottles and crates).
regulated healthcare non-retail consumer trade item	A consumer trade item not intended for scanning at POS and identified with a GTIN-14, GTIN-13, GTIN-12 or GTIN-8 utilising linear or 2D matrix barcodes that can be scanned by image-based scanners.
regulated healthcare retail consumer trade item	A regulated healthcare trade item to be sold to the end consumer at a regulated healthcare retail point-of-sale (pharmacy). They are identified with a GTIN-13, GTIN-12 or GTIN-8 utilising linear or 2D matrix barcodes that can be scanned by image-based scanners.
regulated healthcare trade item	Pharmaceuticals or medical devices that are sold or dispensed in a controlled environment (e.g. retail pharmacy, hospital pharmacy).
responsible entity	The party responsible for the safety and effectiveness of the medical product at a moment in time in its lifecycle, according to the approved regulatory file (including labelling) and regulatory/legal/professional obligations associated with the medical product. (e.g., brand owner, repackager, hospital pharmacy, etc.)

Term	Definition
Restricted Circulation Number (RCN)	Signifies a GS1 identification number used for special applications in restricted environments, defined by the local GS1 Member Organisation (e.g., restricted within a country, company, industry). They are allocated by GS1 for either internal use by companies or to GS1 Member Organisations for assignment based on business needs in their country (e.g., variable measure product identification, couponing).
retail consumer trade item variant	A variation of change to a retail consumer trade item (which may itself be a homogeneous or predefined assortment of other retail consumer trade items) which does not require a new GTIN, but where identification of the variation may be required.
retailer zero-suppression code	A group of ID numbers (separate from Local Assigned Codes), that enable the use of UPC-E barcodes in a closed system environment (not for open supply chain applications).
returnable asset	A reusable entity owned by a company that is used for transport and storage of goods. It is identified with a GRAI.
scanner	An electronic device to read barcode and convert them into electrical signals understandable by a computer device.
separator character	Special character(s) that are defined as part of GS1 symbologies and used to separate concatenated element strings, based on their positioning in the GS1 barcodes.
serial number	A code, numeric or alphanumeric, assigned to an individual instance of an entity for its lifetime. Example: microscope model AC-2 with serial number 1234568 and microscope model AC-2 with serial number 1234569. A unique individual item may be identified with the combined Global Trade Item Number (GTIN) and serial number.
serial reference	A component of the Serial Shipping Container Code (SSCC) assigned by the physical builder or brand owner of the logistic unit to create a unique SSCC.
Serial Shipping Container Code (SSCC)	The GS1 identification key used to identify logistics units. The key comprises an extension digit, GS1 Company Prefix, serial reference, and check digit.
service reference	A component of the Global Service Relation Number (GSRN) assigned by the brand owner to create a unique GSRN.
service relation instance number (SRIN)	An attribute to the GSRN which allows to distinguish different encounters during the same episode, or the reuse of the same GSRN in different episodes.
shipment	A grouping of logistics and transport units assembled and identified by the seller (sender) of the goods travelling under one despatch advice and/or Bill of Lading to one customer (recipient).
short life items	An item, preparation or reconstituted product with limited use / shelf life, such as in healthcare a cytotoxic medicine, that has undergone some manipulation, such as addition of a diluent, in order to make it administrable to a specified patient.
single shipping / retail consumer trade item	A retail consumer trade item that is also regarded as a shipping item and is one to a carton (e.g. a bicycle or a television).
single unit	Single item of medicine/medical device without any package, for example the single tablet in a blister or bottle, the syringe as such.
single unit package / blister	A healthcare primary package that contains one discrete pharmaceutical dosage form, i.e. a tablet, a certain volume of a liquid or that is the immediate package for a medical device like a syringe. A number of single units may be attached to each other, but are easy to separate through a perforation.
special characters	Special characters that are designated by the symbology specification.
sterile packaging system	A combination of the sterile barrier system (the minimum package that prevents ingress of microorganisms and allows aseptic presentation of the product at the point of use) and the protective packaging (configuration of materials designed to prevent damage to the sterile barrier system and its contents until the point of use).
subject of care	Any person who uses or is a potential user of a health care service, subjects of care may also be referred to as patients or health care consumers
substrate	The material on which a barcode is printed.
supplier	The party that produces, provides, or furnishes an item or service.
symbol	The combination of symbol characters and features required by a particular symbology, including Quiet Zone, start and stop characters, data characters, and other auxiliary patterns, which together form a complete scannable entity; an instance of a symbology and a data structure.
symbol character	A group of bars and spaces in a symbol that is decoded as a single unit. It may represent an individual digit, letter, punctuation mark, control indicator, or multiple data characters.

Term	Definition
symbol check character	A symbol character or set of bar/space patterns included within a GS1-128 or GS1 DataBar symbol, the value of which is used by the barcode reader for the purpose of performing a mathematical check to ensure the accuracy of the scanned data. It is not shown in human readable interpretation. It is not input to the barcode printer and is not transmitted by the barcode reader.
symbol contrast	An <i>ISO/IEC 15416</i> parameter that measures the difference between the largest and smallest reflectance values in a Scan Reflectance Profile (SRP).
sympology	A defined method of representing numeric or alphabetic characters in a barcode; a type of barcode.
sympology element	A character or characters in a barcode used to define the integrity and processing of the symbol itself (e.g., start and stop patterns). These elements are sympology overhead and are not part of the data conveyed by the barcode.
sympology identifier	A sequence of characters generated by the decoder (and prefixed to the decoded data transmitted by the decoder) that identifies the sympology from which the data has been decoded.
trade item	Any item (product or service) upon which there is a need to retrieve predefined information and that may be priced, or ordered, or invoiced at any point in any supply chain.
trade item grouping	A predefined composition of trade item(s) that is not intended for point-of-sale scanning. It is identified with a GTIN-14, GTIN-13, or GTIN-12.
trade measures	Net measures of variable measure trade items as used for invoicing (billing) the trade item.
truncation	Printing a symbol shorter than the sympology specification's minimum height recommendations. Truncation can make the symbol difficult for an operator to scan.
U.P.C. Company Prefix	A GS1 Company Prefix starting with a zero ('0') becomes a U.P.C. Company Prefix by removing the leading zero. A U.P.C. Company Prefix is used to issue GTIN-12.
U.P.C. Prefix	A GS1 Prefix starting with a zero ('0') becomes a U.P.C. Prefix by removing the leading zero. A U.P.C. Prefix is used to issue U.P.C. Company Prefixes or allocated to other specific areas.
unit of use	Refers to an individual unit package that is used to make up the patient-specific prescription that is prescribed for administering to a patient.
unrestricted distribution	Signifies that such system data may be applied on goods to be processed anywhere in the world without restraint as to such things as country, company, and industry.
UPC-A barcode	A barcode of the EAN/UPC sympology that encodes GTIN-12 and RCN-12.
UPC-E barcode	A barcode of the EAN/UPC sympology representing a GTIN-12 in six explicitly encoded digits using zero-suppression techniques.
variable measure trade item	A trade item which may be traded without a predefined measure, such as its weight or length.
wide-to-narrow ratio	The ratio between the wide elements and the narrow elements in a barcode sympology such as ITF-14 that has two different element widths.
X-dimension	The specified width of the narrowest element of a barcode.

8.2 GS1 abbreviations

Abbreviation	Term
ADC	Automatic Data Capture
AI	GS1 Application Identifier
AIDC	Automatic Identification and Data Capture
DPM	Direct Part Marking
EAN	EAN International, now called GS1
EDI	Electronic Data Interchange
EPC	Electronic Product Code
FNC1	Function 1 Symbol Character
GCN	Global Coupon Number
GCP	GS1 Company Prefix
GDD	Global Data Dictionary
GDSN	Global Data Synchronisation Network
GDTI	Global Document Type Identifier
GEPIR	Global Electronic Party Information Registry
GIAI	Global Individual Asset Identifier
GINC	Global Identification Number for Consignment
GLN	Global Location Number
GPC	Global Product Classification
GRAI	Global Returnable Asset Identifier
GRCTI	General Retail Consumer Trade Item
GS1 key	GS1 identification key
GSIN	Global Shipment Identification Number
GSMP	Global Standards Management Process
GSRN	Global Service Relation Number
GTIN	Global Trade Item Number
HRI	Human Readable Interpretation
ISBN	International Standard Book Number
ISO	International Organization for Standardization
ISSN	International Standard Serial Number
LAC	Local Assigned Code
NHRN	National Healthcare Reimbursement Number
NTIN	National Trade Item Number
RCN	Restricted Circulation Number
RFID	Radio Frequency Identification
RHRCTI	Regulated healthcare retail consumer trade item
RHTI	Regulated healthcare trade item
RSS	Reduced Space Symbology
RZSC	Retailer Zero-Suppression Code.
SKU	Stock Keeping Unit
SRIN	Service Relation Instance Number
SSCC	Serial Shipping Container Code

8.3 Legacy (retired) terms

When terms are replaced or retired by GS1, they are maintained within this section for a minimum of five years. The legacy terms are supplied to point GS1 stakeholders to new terminology. The period of five years ensures harmonisation with external standards bodies whose standards make normative reference to the *GS1 General Specifications*.

Legacy term	Current term
Coupon-12	See RCN-12
Coupon-13	See RCN-13
EAN	GS1
EAN International	GS1 Global Office
EAN Member Organisation	GS1 Member Organisation
EAN.UCC Company Prefix	GS1 Company Prefix
EAN.UCC Prefix	GS1 Prefix
EAN.UCC XML	GS1 XML
EAN/UCC-8 Data Structure	GTIN-8
EAN/UCC-8 Identification Number	GTIN-8
EAN/UCC-12 Data Structure	See GTIN-12, RCN-12
EAN/UCC-12 Identification Number	See GTIN-12, GLN, GDTI, RCN-12
EAN/UCC-13 Data Structure	See GTIN-13, , RCN-13
EAN/UCC-13 Identification Number	See GTIN-13, GLN, GDTI, RCN-13
EAN/UCC-14 Data Structure	GTIN-14
EAN/UCC-14 Identification Number	GTIN-14
Interleaved 2 of 5	ITF-14 Symbol
Item Number	Item reference
Item Reference Number	Item reference
Manufacturer's ID	No longer used
Manufacturer's Number	GS1 Company Prefix
Number System Character	See U.P.C. Prefix
Numbering Organisation (NO)	GS1 Member Organisation
print gain/loss	bar gain/loss
Reduced Space Symbology	GS1 DataBar Symbology
RSS Composite Symbology Family	GS1 DataBar Composite Symbology Family
RSS Expanded Barcode Symbol	GS1 DataBar Expanded Symbol
RSS Expanded Composite Symbology	GS1 DataBar Expanded Composite Symbology
RSS Expanded Stacked Barcode Symbol	GS1 DataBar Expanded Stacked Symbol
RSS Expanded Stacked Composite Barcode Symbol	GS1 DataBar Expanded Stacked Composite Symbology
RSS Limited Barcode symbol	GS1 DataBar Limited Symbol
RSS Limited Composite Symbology	GS1 DataBar Limited Composite Symbology
RSS Omnidirectional	GS1 DataBar Retail POS family
RSS-14 Barcode Symbol	GS1 DataBar Omnidirectional Symbol
RSS-14 Composite Symbology	GS1 DataBar Composite Symbology
RSS-14 Stacked Barcode Symbol	GS1 DataBar Stacked Symbol
RSS-14 Stacked Composite Symbology	GS1 DataBar Stacked Composite Symbology
Secondary Data for Specific Health Industry Products	This GS1 Application Identifier was retired in 2013.

Legacy term	Current term
SCC-14	Global Trade Item Number
SSCC Serial Number	Serial Reference
standard numbering structures	data structure
Symbol Control Character	sympology element
UCC	GS1 US
UCC Company Prefix	U.P.C. Company Prefix
UCC Prefix	U.P.C. Prefix
UCC-12 Data Structure	See GTIN-12, RCN-12
UCC-12 Identification Number	See GTIN-12, RCN-12
Uniform Code Council, Inc.	GS1 US
Variable Measure Retail Item	See RCN
variable measure number (VMN)	See restricted circulation number (RCN)
VMN-12	See RCN-12
VMN-13	See RCN-13