



The Global Language of Business

GS1 General Specifications Standard

The foundational GS1 standard that defines how identification keys, data attributes and barcodes must be used in business applications.

Release 25.0, Ratified, Jan 25

Document Summary

Document item	Current value
Document name	GS1 General Specifications Standard
Document type	Jan 25
Document date	25.0
Document version	
Document issue	Ratified
Document status	The foundational GS1 standard that defines how identification keys, data attributes and barcodes must be used in business applications.
Document description	GS1 General Specifications Standard
Document web address	https://www.gs1.org/genspecs

Change Log in this release

Impact on section	Gens Specs Change Notification (GSCN)	Summary of change
1		
2	GSCN for 21-283 GSCN for 22-246 GSCN for 23-272 GSCN for 24-004 GSCN for 24-040 GSCN for 24-157	Application standard Master UDI-DI for registration of certain type of devices within EUDAMED Electronic health record patient demographics in GS1 barcodes Freight unit type AI Medical device family definition Clarify GMN for healthcare application NHRN for AIDA (Italian Medicines Agency)
3	GSCN for 21-283 GSCN for 22-246 GSCN for 23-272 GSCN for 24-157	Application standard Master UDI-DI for registration of certain type of devices within EUDAMED Electronic health record patient demographics in GS1 barcodes Freight unit type AI NHRN for AIDA (Italian Medicines Agency)
4	GSCN for 21-283 GSCN for 22-246 GSCN for 23-272 GSCN for 24-157	Application standard Master UDI-DI for registration of certain type of devices within EUDAMED Electronic health record patient demographics in GS1 barcodes Freight unit type AI NHRN for AIDA (Italian Medicines Agency)
5	GSCN for 24-011	Verification template update
6		
7	GSCN for 24-157	NHRN for AIDA (Italian Medicines Agency)
8		
9	GSCN for 21-283 GSCN for 22-246 GSCN for 24-004	Application standard Master UDI-DI for registration of certain type of devices within EUDAMED Electronic health record patient demographics in GS1 barcodes Medical device family definition

Full log of changes on https://www.gs1.org/standards/genspecs/gscn_archive

Disclaimer

GS1 seeks to minimise barriers to the adoption of its standards and guidelines by making the intellectual property required to implement them available, to the greatest extent possible, on a royalty-free basis, or when necessary, under a RAND licence. Such royalty-free and RAND licences are provided pursuant to the GS1 IP Policy (available here: <https://www.gs1.org/standards/ip>), which governs the work of work group participants who contribute to drafting standards and guidelines, including this document. In addition to licences, the GS1 IP Policy provides various benefits and obligations that apply to all implementers of GS1 standards and guidelines, and all implementations of GS1 standards are subject to those terms.

Nevertheless, please note the possibility that an implementation of one or more features of this standard or guideline may be the subject of a patent or other intellectual property right that is not covered by the licences granted pursuant to the IP Policy. In addition, the licences granted under the IP Policy do not include the IP rights or claims of third parties who were not participants in the corresponding standard development work group.

Accordingly, GS1 recommends that any person or organisation developing an implementation of this standard or guideline should determine whether any patents or other intellectual property may encompass such implementation, and whether a licence under a patent or other IP right is needed. The implementer should determine the potential need for licensing in view of the details of the specific implementation being designed in consultation with that party's patent counsel.

The official versions of all GS1 standards and guidelines are provided as PDF files on GS1's online reference directory (<https://ref.gs1.org>) (the "GS1 Reference"). Any other representations of standards or guidelines in any other format (e.g., web pages) are provided for convenience and descriptive purposes only, and in the event of a conflict, the GS1 Reference document shall govern.

THIS DOCUMENT IS PROVIDED "AS IS" WITH NO WARRANTIES WHATSOEVER, EXPRESS OR IMPLIED, INCLUDING ANY WARRANTY OF MERCHANTABILITY, NONINFRINGEMENT, FITNESS FOR PARTICULAR PURPOSE, ACCURACY OR COMPLETENESS, OR ANY WARRANTY OTHERWISE ARISING OUT OF THIS DOCUMENT. GS1 disclaims all liability for any damages arising from any use or misuse of this document, whether special, indirect, consequential, or compensatory damages, and including liability for infringement of any intellectual property rights, relating to use of information in or reliance upon this document.

GS1 makes no commitment to update the information contained herein, and retains the right to make changes to this document at any time, without notice. GS1® and the GS1 logo are registered trademarks of GS1 AISBL.

Who should read the General Specifications?

Technical experts working with the GS1 system should read these specifications. They provide a global reference document covering all technical aspects of the GS1 system. Their primary objective is to define the international standard upon which individual GS1 Member Organisations can develop user documentation.

Navigator

These specifications have been developed as a reference document aimed primarily at GS1 Member Organisations (who also produce local language user manuals) and system engineers developing software based upon GS1 system standards. All aspects of the GS1 system are summarised in section 1, which is recommended for those wishing to become familiar with the GS1 system logic and terminology.

Each application section mandates the use of system features defined elsewhere in this document, such as check digits, element strings, data carriers and barcode symbol placement. The sections of these *GS1 General Specifications* are:

- **Section 1 Basics and principles of the GS1 system:** Provides an introduction to the core components of the GS1 system.
- **Section 2 Application standards:** Provides a definition for each GS1 application using a template format. Each application is uniquely identified and contains a description, the associated GS1 key, its definition and links to relevant data structures and attributes (section 3), rules (section 4), carrier specifications (section 5), placement (section 6) and unique processing requirements (section 7).
- **Section 3 GS1 Application Identifier definitions:** Describes the meaning, structure and function of the GS1 element strings so they can be correctly processed in users' application programs.
- **Section 4 Application rules:** Provides the rules for use of GS1 keys in their application environments. Differences in industries are included as well as the data relationship rules for GS1 Application Identifier use.
- **Section 5 Data carriers:** Provides a detailed description of the data carriers that are endorsed by GS1. It includes symbol specification tables for use in the supply chain operational environment as well as the related barcode production and quality assessment required to achieve excellent scan rates.
- **Section 6 Barcode placement:** Provides guidance on symbol placement as well as transport label standards and tag standards.
- **Section 7 AIDC validation rules:** Provides rules for validating and processing GS1 element strings without human intervention. Check digit and calendar date algorithms are also included.
- **Section 8 Application Standard Profiles** Provides a summary of current application and future state conformance requirements, organised in modular way to make it easier to find the relevant sections.
- **Section 9 GS1 Standards glossary of terms** A standard vocabulary used throughout the GS1 system.

Table of Contents

1	Basics and principles of the GS1 system	15
1.1	The GS1 General Specifications.....	15
1.1.1	Introduction	15
1.1.2	Who should read these specifications	15
1.1.3	Foundational standard	15
1.1.4	Maintenance responsibility and management.....	16
1.1.5	Verbal forms used in normative statements	16
1.2	GS1 system principles	16
1.3	Identification system policies	16
1.3.1	Mandatory identifiers.....	16
1.3.2	Non-GS1 identifiers.....	16
1.3.3	GS1 Company Prefix	16
1.3.4	Carrier independence	17
1.3.5	GS1 business messages.....	17
1.4	The GS1 identification system.....	17
1.4.1	Global, open versus restricted	17
1.4.2	GS1 Prefix	17
1.4.3	GS1-8 Prefix	18
1.4.4	GS1 Company Prefix	18
1.4.5	U.P.C. Prefix.....	19
1.4.6	U.P.C. Company Prefix	19
1.4.7	GS1 identification key	19
1.4.8	Character set	20
1.5	GS1 identification licensing.....	20
1.6	Licence management.....	21
1.6.1	Acquisitions and mergers.....	21
1.6.2	Split or spin-off	22
1.6.3	GS1 identification keys transferred to an acquiring, partial purchase, or spin-off company	22
1.7	Sunrise and sunset dates	23
2	Application standards	24
2.1	Trade items.....	24
2.1.1	Introduction	24
2.1.2	Fixed measure trade items – open supply chain.....	29
2.1.3	Fixed measure trade items scanned at retail POS.....	29
2.1.4	Fixed measure trade items scanned in general distribution and at retail POS.....	38
2.1.5	Healthcare primary packaging (non-retail trade items)	38
2.1.6	Healthcare secondary packaging (regulated healthcare retail consumer trade items).....	42
2.1.7	Fixed measure trade items scanned in general distribution.....	44
2.1.8	Medical devices (non-retail trade items)	51
2.1.9	Fixed measure trade items packed in several individual pieces not scanned at retail POS.....	52
2.1.10	Variable measure trade items scanned in general distribution.....	53
2.1.11	Fixed measure trade items – restricted distribution applications.....	60
2.1.12	Variable measure trade items scanned at retail POS.....	65
2.1.13	Trade item extended packaging applications	69
2.1.14	European Regulation 2018/574, traceability of tobacco products.....	73

- 2.1.15 Identification of non-new trade items 80
- 2.2 Logistic units 82
 - 2.2.1 Individual logistic units 83
 - 2.2.2 Multiple logistic units – Global Identification Number for Consignment..... 84
 - 2.2.3 Multiple logistic units – Global Shipment Identification Number..... 85
- 2.3 Assets 86
 - 2.3.1 Global Returnable Asset Identifier (GRAI): AI (8003) 87
 - 2.3.2 Global Individual Asset Identifier (GIAI): AI (8004)..... 88
- 2.4 Parties and locations..... 90
 - 2.4.1 Application overview 90
 - 2.4.2 Identification of a physical location 91
 - 2.4.3 Physical locations in business processes..... 93
 - 2.4.4 Identification of a party 94
 - 2.4.5 Parties in business processes 95
- 2.5 Service relationships..... 96
 - 2.5.1 Global Service Relation Number – Provider: AI (8017)..... 97
 - 2.5.2 Global Service Relation Number – Recipient: AI (8018) 98
 - 2.5.3 Service Relation Instance Number: AI (8019).....100
 - 2.5.4 Use of demographic data to support verification or validation of personal identity101
- 2.6 Special applications102
 - 2.6.1 Coupons102
 - 2.6.2 Coupons identified using the Global Coupon Number103
 - 2.6.3 Coupons with restricted geographic distribution107
 - 2.6.4 Refund receipts111
 - 2.6.5 Electronic serial identifier for cellular mobile telephones (CMTI): AI (8002)112
 - 2.6.6 Payment slips.....113
 - 2.6.7 Customer specific articles115
 - 2.6.8 Custom trade item120
 - 2.6.9 Global Document Type Identifier for document control122
 - 2.6.10 Internal applications.....127
 - 2.6.11 Consumer trade item production control127
 - 2.6.12 Component/part identification129
 - 2.6.13 Global Model Number (GMN)132
 - 2.6.14 Permanently marked items134
 - 2.6.15 Encoding transport process information136
 - 2.6.16 Digital Signature (DigSig)138
 - 2.6.17 Restricted application – highly individualised device identifier via Master Unique Device Identifier – Device Identifier (MUDI-DI).....140
- 2.7 Summary of applications and operative scanning environments143

3 GS1 Application Identifier definitions 146

- 3.1 Introduction146
- 3.2 GS1 Application Identifiers in numerical order.....146
- 3.3 GS1 Application Identifiers starting with digit 0.....153
 - 3.3.1 Identification of a logistic unit (SSCC): AI (00)153
 - 3.3.2 Identification of a trade item (GTIN): AI (01)153
 - 3.3.3 Identification of trade items contained in a logistic unit: AI (02)153
 - 3.3.4 Identification of a Made-to-Order (MtO) trade item (GTIN): AI (03)154
- 3.4 GS1 Application Identifiers starting with digit 1155

3.4.1	Batch or lot number: AI (10).....	155
3.4.2	Production date: AI (11).....	155
3.4.3	Due date for amount on payment slip: AI (12)	156
3.4.4	Packaging date: AI (13).....	156
3.4.5	Best before date: AI (15).....	157
3.4.6	Sell by date: AI (16)	158
3.4.7	Expiration date: AI (17).....	158
3.5	GS1 Application Identifiers starting with digit 2.....	159
3.5.1	Internal product variant: AI (20)	159
3.5.2	Serial number: AI (21)	160
3.5.3	Consumer product variant: AI (22)	160
3.5.4	Third Party Controlled, Serialised Extension of Global TradeItem Number (GTIN) (TPX) : AI (235)	160
3.5.5	Additional product identification assigned by the manufacturer: AI (240).....	161
3.5.6	Customer part number: AI (241)	162
3.5.7	Made-to-Order variation number: AI (242)	162
3.5.8	Packaging component number: AI (243).....	162
3.5.9	Secondary serial number: AI (250)	163
3.5.10	Reference to source entity: AI (251)	163
3.5.11	Global Document Type Identifier (GDTI): AI (253).....	164
3.5.12	Global Location Number (GLN) extension component: AI (254)	164
3.5.13	Global Coupon Number (GCN): AI (255).....	165
3.6	GS1 Application Identifiers starting with digit 3.....	165
3.6.1	Variable count of items: AI (30)	165
3.6.2	Trade measures: AIs (31nn, 32nn, 35nn, 36nn)	166
3.6.3	Logistic measures: AIs (33nn, 34nn, 35nn, 36nn).....	167
3.6.4	Kilograms per square metre: AI (337n)	168
3.6.5	Count of trade items or trade item pieces contained in a logistic unit: AI (37)	168
3.6.6	Amount payable or coupon value - Single monetary area: AI (390n).....	169
3.6.7	Amount payable and ISO currency code: AI (391n).....	169
3.6.8	Amount payable for a variable measure trade item – Single monetary area: AI (392n)..	170
3.6.9	Amount payable for a variable measure trade item and ISO currency code: AI (393n)..	171
3.6.10	Percentage discount of a coupon: AI (394n).....	171
3.6.11	Amount payable per unit of measure single monetary area (variable measure trade item): AI (395n)	172
3.7	GS1 Application Identifiers starting with digit 4.....	172
3.7.1	Customer’s purchase order number: AI (400).....	172
3.7.2	Global Identification Number for Consignment (GINC): AI (401)	173
3.7.3	Global Shipment Identification Number (GSIN): AI (402).....	173
3.7.4	Routing code: AI (403).....	174
3.7.5	Ship to - Deliver to Global Location Number (GLN): AI (410).....	175
3.7.6	Bill to - Invoice to Global Location Number (GLN): AI (411)	175
3.7.7	Purchased from Global Location Number (GLN): AI (412)	175
3.7.8	Ship for - Deliver for - Forward to Global Location Number (GLN): AI (413)	176
3.7.9	Identification of a physical location - Global Location Number (GLN): AI (414)	176
3.7.10	Global Location Number (GLN) of the invoicing party: AI (415).....	177
3.7.11	Global Location Number (GLN) of the production or service location: AI (416).....	177
3.7.12	Party Global Location Number (GLN): AI (417)	178
3.7.13	Ship-to / Deliver-to postal code within a single postal authority: AI (420).....	178

3.7.14	Ship-to / Deliver-to postal code with three-digit ISO country code: AI (421)	178
3.7.15	Country of origin of a trade item: AI (422)	179
3.7.16	Country of initial processing: AI (423)	179
3.7.17	Country of processing: AI (424)	180
3.7.18	Country of disassembly: AI (425)	180
3.7.19	Country covering full process chain: AI (426)	180
3.7.20	Country subdivision of origin code for a trade item: AI (427)	181
3.7.21	Ship-to / Deliver-to Company name: AI (4300)	181
3.7.22	Ship-to / Deliver-to contact name: AI (4301)	182
3.7.23	Ship-to / Deliver-to address line 1: AI (4302)	182
3.7.24	Ship-to / Deliver-to address line 2: AI (4303)	182
3.7.25	Ship-to / Deliver-to suburb: AI (4304)	183
3.7.26	Ship-to / Deliver-to locality: AI (4305)	183
3.7.27	Ship-to / Deliver-to region: AI (4306)	183
3.7.28	Ship-to / Deliver-to country code: AI (4307)	184
3.7.29	Ship-to / Deliver-to telephone number: AI (4308)	184
3.7.30	Ship-to / Deliver-to GEO location: AI (4309)	184
3.7.31	Return-to company name: AI (4310)	185
3.7.32	Return-to contact name: AI (4311)	185
3.7.33	Return-to address line 1: AI (4312)	185
3.7.34	Return-to address line 2: AI (4313)	186
3.7.35	Return-to suburb: AI (4314)	186
3.7.36	Return-to locality: AI (4315)	186
3.7.37	Return-to region: AI (4316)	187
3.7.38	Return-to country code: AI (4317)	187
3.7.39	Return-to postal code: AI (4318)	187
3.7.40	Return-to telephone number: AI (4319)	187
3.7.41	Service code description: AI (4320)	188
3.7.42	Dangerous goods flag: AI (4321)	188
3.7.43	Authority to leave flag: AI (4322)	189
3.7.44	Signature required flag: AI (4323)	189
3.7.45	Not before delivery date/time: AI (4324)	189
3.7.46	Not after delivery date/time: AI (4325)	190
3.7.47	Release date: AI (4326)	190
3.7.48	Maximum temperature in Fahrenheit: AI (4330)	191
3.7.49	Maximum temperature in Celsius: AI (4331)	191
3.7.50	Minimum temperature in Fahrenheit: AI (4332)	192
3.7.51	Minimum temperature in Celsius: AI (4333)	192
3.8	GS1 Application Identifiers starting with digit 7	193
3.8.1	Seven series AIs - Cautionary note	193
3.8.2	NATO Stock Number (NSN): AI (7001)	193
3.8.3	UNECE meat carcasses and cuts classification: AI (7002)	194
3.8.4	Expiration date and time: AI (7003)	194
3.8.5	Active potency: AI (7004)	195
3.8.6	Catch area: AI (7005)	195
3.8.7	First freeze date: AI (7006)	196
3.8.8	Harvest date: AI (7007)	196
3.8.9	Species for fishery purposes: AI (7008)	197
3.8.10	Fishing gear type: AI (7009)	197

3.8.11	Production method: AI (7010)	198
3.8.12	Test by date: AI (7011)	198
3.8.13	Refurbishment lot ID: AI (7020)	199
3.8.14	Functional status: AI (7021)	199
3.8.15	Revision status: AI (7022)	200
3.8.16	Global Individual Asset Identifier of an assembly: AI (7023)	200
3.8.17	Number of processor with three-digit ISO country code: AI (703s)	201
3.8.18	GS1 UIC with Extension 1 and Importer index: AI (7040)	201
3.8.19	UN/CEFACT freight unit type: AI (7041)	202
3.8.20	National Healthcare Reimbursement Number (NHRN): AIs (710), (711), (712), (713), (714), (715) and (716)	202
3.8.21	Certification reference: AI (723s)	204
3.8.22	Protocol ID: AI (7240)	204
3.8.23	AIDC media type: AI (7241)	205
3.8.24	Version Control Number (VCN): AI (7242)	206
3.8.25	Date of birth: AI (7250)	207
3.8.26	Date and time of birth: AI (7251)	207
3.8.27	Biological sex: AI (7252)	208
3.8.28	Family name of person: AI (7253)	208
3.8.29	Given name of person: AI (7254)	209
3.8.30	Name suffix of person: AI (7255)	209
3.8.31	Full name of person: AI (7256)	210
3.8.32	Address of person: AI (7257)	211
3.8.33	Baby birth sequence indicator: AI (7258)	211
3.8.34	Baby of family name: AI (7259)	212
3.9	GS1 Application Identifiers starting with digit 8	212
3.9.1	Roll products - width, length, core diameter, direction, splices: AI (8001)	212
3.9.2	Cellular mobile telephone identifier: AI (8002)	213
3.9.3	Global Returnable Asset Identifier (GRAI): AI (8003)	213
3.9.4	Global Individual Asset Identifier (GIAI): AI (8004)	214
3.9.5	Price per unit of measure: AI (8005)	214
3.9.6	Identification of an individual trade item piece (ITIP): AI (8006)	215
3.9.7	International Bank Account Number (IBAN): AI (8007)	215
3.9.8	Date and time of production: AI (8008)	215
3.9.9	Optically readable sensor indicator: AI (8009)	216
3.9.10	Component/Part Identifier (CPID): AI (8010)	216
3.9.11	Component/Part Identifier serial number: AI (8011)	217
3.9.12	Software version: AI (8012)	217
3.9.13	Global Model Number (GMN): AI (8013)	218
3.9.14	Highly Individualised Device Registration Identifier (HIDRI): AI (8014)	218
3.9.15	Global Service Relation Number (GSRN): AIs (8017, 8018)	219
3.9.16	Service Relation Instance Number (SRIN): AI (8019)	220
3.9.17	Payment slip reference number: AI (8020)	220
3.9.18	Identification of pieces of a trade item (ITIP) contained in a logistic unit: AI (8026)	220
3.9.19	Digital Signature (DigSig): AI (8030)	221
3.9.20	Coupon code identification for use in North America (AI 8110)	221
3.9.21	Loyalty points of a coupon: AI (8111)	222
3.9.22	Positive offer file coupon code identification for use in North America: (AI 8112)	222
3.9.23	Extended packaging URL: AI (8200)	222

3.10 GS1 Application Identifiers starting with digit 9.....223
 3.10.1 Information mutually agreed between trading partners: AI (90)223
 3.10.2 Company internal information: AIs (91 - 99).....223
 3.11 Compatibility of EPC Tag Data Standard and GS1 General Specifications223

4 Application rules and management practices..... 225

4.1 Introduction225
 4.2 GTIN rules.....225
 4.2.1 Management of uniqueness.....225
 4.2.2 Allocating the numbers.....225
 4.2.3 Responsibility for allocating the Global Trade Item Number.....228
 4.2.4 Sector-specific rules.....229
 4.2.5 GTIN non-reuse.....231
 4.2.6 Data alignment.....231
 4.2.7 GTIN-8 guidelines and packaging size constraints232
 4.3 SSCC rules233
 4.3.1 Allocating Serial Shipping Container Codes.....233
 4.3.2 Aggregated/nested logistic units233
 4.4 Rules for GS1 asset identifiers234
 4.4.1 General rule.....234
 4.4.2 Allocating Global Returnable Asset Identifiers (GRAIs): AI (8003).....234
 4.4.3 Allocating Global Individual Asset Identifiers (GIAIs): AI (8004)235
 4.4.4 Change of asset ownership235
 4.4.5 Information associated with asset identifiers235
 4.5 GLN rules.....236
 4.5.1 Allocating Global Location Numbers.....236
 4.5.2 GLN non-reuse237
 4.5.3 Information associated with a Global Location Number238
 4.6 GSRN rules.....238
 4.6.1 Allocating Global Service Relation Numbers.....238
 4.7 GDTI rules239
 4.7.1 Allocating Global Document Type Identifiers.....239
 4.7.2 GDTI change rules240
 4.8 GINC rules240
 4.8.1 Allocating Global Identification Numbers for Consignment (GINC).....240
 4.9 GSIN rules240
 4.9.1 Allocating Global Shipment Identification Numbers.....240
 4.10 CPID rules.....241
 4.10.1 Allocating Component/Part Identifiers241
 4.11 GCN rules241
 4.11.1 Allocating Global Coupon Numbers.....241
 4.12 GMN rules241
 4.12.1 Allocating Global Model Numbers241
 4.12.2 Information associated with Global Model Numbers.....241
 4.13 Data relationships242
 4.13.1 Invalid pairs of element strings.....242
 4.13.2 Mandatory association of element strings.....244
 4.14 Human readable interpretation (HRI) rules.....251
 4.14.1 Healthcare human readable interpretation rules.....254

- 4.14.2 General retail consumer trade item human readable text rules256
- 4.14.3 Manual date marking.....258
- 4.15 Multiple barcode management practices for trade items (cross-sector)259
 - 4.15.1 Multiple barcode management practices for trade items (all sectors).....259
 - 4.15.2 GS1 multiple barcode management practice for general retail259
 - 4.15.3 GS1 multiple barcode management practices for healthcare.....260
- 4.16 Deprecated rules.....263
 - 4.16.1 Deprecated GTIN reuse rules.....263
 - 4.16.2 Deprecated GLN reuse rules264

5 Data carriers..... 265

- 5.1 Introduction265
 - 5.1.1 Overview of GS1 barcodes265
 - 5.1.2 International data carrier standards268
 - 5.1.3 Symbology identifiers270
- 5.2 Linear barcodes - EAN/UPC symbology specifications271
 - 5.2.1 Symbology characteristics.....271
 - 5.2.2 Symbol formats272
 - 5.2.3 Dimensions and tolerances.....279
 - 5.2.4 Reference decode algorithm281
 - 5.2.5 Human readable interpretation284
 - 5.2.6 Additional features.....285
- 5.3 Linear barcodes - ITF-14 symbology specifications291
 - 5.3.1 Symbology characteristics.....291
 - 5.3.2 Symbol structure291
 - 5.3.3 Additional features (informative)295
 - 5.3.4 Guidelines for the use of ITF-14 (informative)296
 - 5.3.5 Symbology identifier (informative)296
 - 5.3.6 Test specifications (informative)296
- 5.4 Linear barcodes - GS1-128 symbology specifications297
 - 5.4.1 GS1-128 symbology characteristics.....297
 - 5.4.2 GS1-128 barcode structure298
 - 5.4.3 GS1-128 symbology character assignments299
 - 5.4.4 Dimensional requirements305
 - 5.4.5 Reference decode algorithm307
 - 5.4.6 Symbol quality309
 - 5.4.7 GS1-128 symbology application parameters.....310
- 5.5 Linear barcodes - GS1 DataBar313
 - 5.5.1 Introduction313
 - 5.5.2 Symbol structure314
 - 5.5.3 Human readable interpretation in GS1 DataBar symbols322
 - 5.5.4 Data transmission and symbology identifier prefixes322
 - 5.5.5 Width of a module (X-dimension).....323
 - 5.5.6 Height of symbol323
 - 5.5.7 Print quality grade323
 - 5.5.8 Advice for selecting the symbology323
- 5.6 Two-dimensional barcodes - GS1 DataMatrix symbology324
 - 5.6.1 Introduction324
 - 5.6.2 GS1 DataMatrix features and symbol basics325

- 5.6.3 GS1 DataMatrix symbology326
- 5.7 Two-dimensional barcodes - GS1 QR Code symbology330
 - 5.7.1 Introduction330
 - 5.7.2 GS1 QR Code features and symbol basics330
 - 5.7.3 Summary of additional features331
 - 5.7.4 GS1 QR Code symbology332
- 5.8 Two dimensional barcodes - GS1 DotCode symbology.....336
 - 5.8.1 Introduction336
 - 5.8.2 GS1 DotCode symbology336
- 5.9 Two dimensional barcodes - Data Matrix symbology337
- 5.10 Two dimensional barcodes - QR Code symbology337
- 5.11 Composite barcodes337
 - 5.11.1 Composite symbology introduction.....337
 - 5.11.2 Symbol structure339
 - 5.11.3 Human readable interpretation of Composite symbols343
 - 5.11.4 Data transmission and symbology identifier prefixes344
 - 5.11.5 Width of a module (X)345
 - 5.11.6 Print quality345
 - 5.11.7 Advice for selecting a symbology345
 - 5.11.8 Sample Composite symbols.....346
- 5.12 Barcode production and quality assessment.....347
 - 5.12.1 Introduction347
 - 5.12.2 Dimensional specifications and operational requirements348
 - 5.12.3 GS1 symbol specification tables.....354
 - 5.12.4 Barcode production378
 - 5.12.5 Quality assessment.....384
 - 5.12.6 Print process characterisation techniques.....396
 - 5.12.7 GS1 barcode verification template.....398
- 5.13 UHF and HF EPC/RFID403

6 Barcode placement 404

- 6.1 Introduction404
- 6.2 General placement principles404
 - 6.2.1 Number of barcodes.....404
 - 6.2.2 Scanning environment.....404
 - 6.2.3 Orientation405
- 6.3 General placement guidelines for point-of-sale (POS)408
 - 6.3.1 Number of barcodes.....408
 - 6.3.2 Identifying the back of the trade item408
 - 6.3.3 Barcode placement408
- 6.4 Placement guidelines for specific package types414
 - 6.4.1 Bags415
 - 6.4.2 Blister packs416
 - 6.4.3 Bottles and jars417
 - 6.4.4 Boxes.....418
 - 6.4.5 Cans and cylinders.....418
 - 6.4.6 Carded items.....419
 - 6.4.7 Egg cartons.....420
 - 6.4.8 Jugs.....421

- 6.4.9 Large, heavy, or bulky items421
- 6.4.10 Multipacks423
- 6.4.11 Publishing items424
- 6.4.12 Thin items or containers426
- 6.4.13 Trays427
- 6.4.14 Tubes427
- 6.4.15 Tubs428
- 6.4.16 Unpackaged items428
- 6.4.17 Sets (grouping of individually barcoded items)430
- 6.4.18 Sporting goods432
- 6.4.19 Textured surfaces442
- 6.5 Barcode placement for clothing and fashion accessories442
 - 6.5.1 Information zones concept443
 - 6.5.2 Hangtag (hanging label) format445
 - 6.5.3 Sewn-on (joker) label format446
 - 6.5.4 Sewn-in label formats448
 - 6.5.5 Plastic packaged products label location guidelines.....449
 - 6.5.6 Boxed products label formats451
 - 6.5.7 Banded products label formats453
- 6.6 GS1 Logistic Label design454
 - 6.6.1 Scope455
 - 6.6.2 Concepts455
 - 6.6.3 GS1 Logistic Label design455
 - 6.6.4 Technical specifications.....457
 - 6.6.5 Label examples.....459
- 6.7 Barcode placement used in general distribution.....466
 - 6.7.1 General rule467
 - 6.7.2 Recommendation to include a barcode on two sides469
 - 6.7.3 Supplemental barcodes470
- 6.8 Barcode placement for regulated healthcare trade items470
 - 6.8.1 Blister cells470
 - 6.8.2 Products requiring variable data on primary and secondary packaging.....471
- 6.9 Barcode placement for non-new trade items471

7 AIDC validation rules 472

- 7.1 Introduction472
- 7.2 Synopsis of message processing473
 - 7.2.1 Analysis of the data carrier and plausibility test for element strings.....474
 - 7.2.2 Symbology identification474
 - 7.2.3 Prefix in internal table475
 - 7.2.4 Item Identification475
 - 7.2.5 GS1 Application Identifier (AI) in internal table.....475
 - 7.2.6 Length of data 14 Digits475
 - 7.2.7 Check digit calculation and other system checks475
 - 7.2.8 Move element string to message field.....475
- 7.3 Validation of the electronic message regarding system consistency476
- 7.4 Validation of the electronic message regarding user requirements.....477
- 7.5 Conversion of weights and measures in user applications.....477
- 7.6 Linkage of GTINs in a database.....478

7.6.1	The principle	478
7.6.2	Extended example of a trade item hierarchy	479
7.6.3	Linkage of GTINs in a non-relational database by trade item manufacturer	480
7.7	Element strings represented in data carriers.....	481
7.8	Processing of data from a GS1 symbology using GS1 Application Identifiers	483
7.8.1	General	484
7.8.2	GS1 Application Identifier lengths	484
7.8.3	Element strings with predefined lengths using GS1 Application Identifiers.....	484
7.8.4	The separator character and its value.....	484
7.8.5	The basic structure of GS1 barcodes using GS1 Application Identifiers and concatenation.....	485
7.8.6	Concatenation	486
7.8.7	GS1 Application Identifiers with implied decimal point positions.....	489
7.8.8	National Healthcare Reimbursement Number (NHRN)	489
7.9	Check digit/character calculations	490
7.9.1	Standard check digit calculations for GS1 data structures	490
7.9.2	Check digit calculation for price/weight fields	491
7.9.3	Check digit calculation for the four-digit price field	492
7.9.4	Check digit calculation for the five-digit price field.....	492
7.9.5	Check character calculation (for alphanumeric keys)	493
7.10	GTIN-12 and RCN-12 in a UPC-E barcode.....	495
7.11	The GS1 subset of International Standard ISO/IEC 646	496
7.12	Determination of century in dates	499
7.13	Conversion of latitude and longitude to twenty-digit string	500
7.14	Conversion of twenty-digit string to latitude and longitude	500
8	Application Standard Profiles.....	501
8.1	Introduction	501
8.2	ASP 1: Fixed measure trade items scanned at retail POS.....	502
8.3	ASP 2: Fixed measure trade items scanned at retail POS and in general distribution.....	504
8.4	ASP 3: Variable measure trade items scanned at retail POS.....	506
8.5	ASP 4: General retail consumer trade item with extended packaging	508
9	GS1 Standards glossary of terms	510
9.1	GS1 glossary of terms and definitions.....	510
9.2	Legacy (retired) terms	521
9.3	GS1 abbreviations.....	521

1 Basics and principles of the GS1 system

1.1 The GS1 General Specifications

1.1.1 Introduction

The GS1 system originated in the United States and was established in 1973 by the Uniform Product Code Council, subsequently known as the Uniform Code Council, Inc. (UCC). Following the success of this U.P.C. system, the European Article Numbering Association, subsequently known as EAN International, was established in 1977 to develop a compatible system for use outside North America. In February 2005, GS1 was officially launched as the successor to the organisations previously known as EAN and UCC, and the system became known under its current name: The GS1 system.

The GS1 system of standards aims to raise the efficiency of business processes and to provide cost savings through automation based on globally unique identification and digital information.

The GS1 system provides for the use of unambiguous identification keys to identify goods, services, assets, locations, etc. worldwide. These keys can be represented in data carriers, such as barcodes or EPC/RFID tags, to enable automatic data capture. They may also be used in electronic communications, improving speed and accuracy when sharing master data, transactional data and visibility event data.

The GS1 system is designed to overcome the limitations of using company-, organisation-, or sector-specific interfaces. It enables large scale deployment, flexibility in the selection of the most suitable system components and innovation – ultimately making trade much more efficient and responsive to customers.

The GS1 system is designed for use in any industry or trade sector, and changes to the system are introduced in a way that does not disrupt existing users.

This document defines the rules for the use of the GS1 system within Automatic Identification and Data Capture (AIDC) applications and technologies. It supersedes all previous AIDC technical documents provided and/or published by GS1 or its predecessor organisations. Every organisation using the GS1 standards is expected to conform fully to the *GS1 General Specifications*.

1.1.2 Who should read these specifications

The *GS1 General Specifications* are the foundational GS1 standard that defines how identification keys, data attributes and barcodes must be used in business applications.

The primary audience are technically oriented staff members of companies, solution providers and GS1 Member Organisations.

The standard is maintained in English and may be translated into other languages by local GS1 Member Organisations.

1.1.3 Foundational standard

These *GS1 General Specifications* are used as a foundation for other GS1 standards and services such as:

- GS1 Registry Platform
- GDSN
- GS1 EDI (Electronic Data Interchange), including the GS1 EANCOM® and GS1 XML standards
- GS1 EPCIS

The definitions in the *GS1 General Specifications* are the basis for the [GS1 glossary](#).

1.1.4 Maintenance responsibility and management

The GS1 Global Standards Management Process (GSMP) is the mechanism to approve the adoption of additions and changes to the *GS1 General Specifications*. The process is fully defined in the [Global Standards Management Process Manual](#).

1.1.5 Verbal forms used in normative statements

In GS1 standards, normative statements are written using the verbal forms defined per the [GS1 Style Guide](#). These include SHALL, SHALL NOT, SHOULD and SHOULD NOT. When these words are written in a normative statement, using the special meanings defined, they are written in all capitals to distinguish them from ordinary English use of the same words.

For a precise definition of these verbal forms, see the [GS1 Style Guide](#). Briefly, their meanings are summarised as follows:

- SHALL means that all conforming implementations must do what the statement says, otherwise the implementation is not conforming. No deviation is permitted.
- SHOULD means that among several possibilities one is recommended as particularly suitable for a conforming implementation, without mentioning or excluding others. In other words, a conforming implementation is expected to do what the statement says, but might not if there is a good reason not to. It is similar to a MAY statement, but carries a stronger expectation that an implementation will usually do what the statement says.

1.2 GS1 system principles

The GS1 system embodies an open architecture approach. It has been carefully designed for modular expansion with minimal disruption to existing applications. Enterprise Resource Planning (ERP) and other supply chain application software drive implementation of the system. New user driven applications can be expected, and this document will be updated accordingly.

The maintenance of these specifications will be the responsibility of GS1 and will be in line with the [GS1 Architecture Principles](#).

1.3 Identification system policies

The GS1 identification system provides the world a globally unique and unambiguous identification system for physical entities, parties and relationships exchanged in the supply chain. The policies that follow apply to all sectors making use of the GS1 Company Prefix in association with GS1 keys and the Application Identification System. These policies provide for the long-term integrity of the GS1 identification system so vital to the global supply chain.

1.3.1 Mandatory identifiers

All GS1 standards shall incorporate GS1 identification standards as mandatory identifiers exclusive of all other mandatory identifiers.

1.3.2 Non-GS1 identifiers

Non-GS1 identifiers may only be used with GS1 standards as additional identifiers (not alternates). Implementations using non-GS1 identifiers as primary identifiers are not compliant with GS1 standards.

1.3.3 GS1 Company Prefix

The GS1 Company Prefix is used exclusively within GS1 identification standards that may be expressed in GS1 approved barcode applications, in GS1 EDI messages, for global data synchronisation, network registration and in EPC tags within the header values reserved for the GS1 system. See section [1.4](#) for further details on the GS1 Company Prefix allocation.

1.3.4 Carrier independence

GS1 identification keys are defined and utilised per GS1 definitions independent of data carrier (e.g., barcode, radio frequency identification (RFID), business message).

1.3.5 GS1 business messages

GS1 business messages or GS1 standards-based applications use GS1 identification keys for identification exclusive of GS1 data carrier features. Examples of data carrier features include the use of:

- Modulo 103 GS1-128 symbol check character to secure data capture.
- Function 1 Symbol Character (FNC1) in the second position of GS1-128 barcode or an Electronic Product Code (EPC) header value to discriminate between GS1 data content and data carrier overhead.
- Separator characters or EPC parsing values to parse a decoded data string into significant data parts.

 **Exception:** If an EPC user is using GS1 system and non-GS1 system headers to support an application, this policy does not apply, and advice should be sought on the use of EPC headers to provide uniqueness among multiple numbering systems.

1.4 The GS1 identification system

1.4.1 Global, open versus restricted

1.4.1.1 Global, open numbers (unrestricted distribution)

Global, open is an identification number used in unrestricted distribution which signifies that such system data may be applied on goods to be processed anywhere in the world without restraint as to such things as country, company and industry.

1.4.1.2 Restricted Circulation Numbers (RCNs)

Restricted Circulation Numbers (RCNs) are GS1 identification numbers used for special applications in restricted environments, defined by the local GS1 Member Organisation (e.g., restricted within a country, company, or industry). They are allocated by GS1 for either internal use by companies or to GS1 Member Organisations for assignment based on business needs in their country (e.g., variable measure trade item identification, coupons):

- RCN-12 is a 12-digit Restricted Circulation Number.
- RCN-13 is a 13-digit Restricted Circulation Number.
- RCN-8 is an 8-digit Restricted Circulation Number.

Restricted circulation numbers (RCNs) SHALL only be encoded in EAN-8, EAN-13, UPC-A, or UPC-E barcodes. RCNs SHALL NOT be encoded using any Application Identifiers.

1.4.2 GS1 Prefix

The GS1 Prefix is a unique string of two or more digits, issued by the GS1 Global Office, and allocated to GS1 Member Organisations to issue GS1 Company Prefixes or allocated to other specific areas listed in figure [1.4.2-1](#). The main purpose of the GS1 Prefix is to allow decentralisation of the administration of identification numbers. GS1 Prefix ranges are shown in figure [1.4.2-1](#).

 **Note:** As the GS1 Prefix varies in length, the issuance of a GS1 Prefix excludes all longer strings that start with the same digits from being issued as GS1 Prefixes.

Figure 1.4.2-1. Synopsis of GS1 Prefix ranges

GS1 Prefix range	Significance
0000000	Used to issue Restricted Circulation Numbers within a company
0000001 – 0000099	Unused to avoid collision with GTIN-8
00001 – 00009 0001 – 0009 001 – 019	Used to issue GS1 Company Prefixes from which U.P.C. Company Prefixes can be derived
02	Used to issue Restricted Circulation Numbers within a geographic region
03	Used to issue GS1 Company Prefixes from which U.P.C. Company Prefixes can be derived
04	Used to issue Restricted Circulation Numbers within a company
05	GS1 US reserved for future use
06 – 09	Used to issue GS1 Company Prefixes from which U.P.C. Company Prefixes can be derived
10 – 19	Used to issue GS1 Company Prefixes
20 – 29	Used to issue Restricted Circulation Numbers within a geographic region
300 – 950	Used to issue GS1 Company Prefixes
951	Used to issue General Manager Numbers for the EPC General Identifier (GID) scheme as defined by the EPC Tag Data Standard
952	Used for demonstrations and examples of the GS1 system
953 – 976	Used to issue GS1 Company Prefixes
977	Allocated to ISSN International Centre for serial publications
978 – 979	Allocated to International ISBN Agency for books, a portion of 979 sub-allocated to International ISMN Agency for music
980	Used to issue GS1 identification of refund receipts
981 – 983	Used to issue GS1 coupon identification for common currency areas
984 – 989	Reserved for future GS1 coupon identification
99	Used to issue GS1 coupon identification

1.4.3 GS1-8 Prefix

The GS1-8 Prefix is a unique string of two or more digits issued by GS1 Global Office and allocated to GS1 Member Organisations to issue GTIN-8s or allocated to other specific areas. GS1-8 Prefixes are shown in figure [1.4.3-1](#).

Figure 1.4.3-1. Synopsis of GS1-8 Prefixes

GS1-8 Prefixes	Significance
000 – 099	Used to issue Restricted Circulation Numbers within a company
100 – 199	Used to issue GTIN-8s
200 – 299	Used to issue Restricted Circulation Numbers within a company
300 – 951	Used to issue GTIN-8s
952	Used for demonstrations and examples of the GS1 system
953 – 976	Used to issue GTIN-8s
977 – 999	Reserved for future use

1.4.4 GS1 Company Prefix

A GS1 Company Prefix is a unique string of four to twelve digits used to issue GS1 identification keys. The first digits are a valid GS1 Prefix and the length of the GS1 Company Prefix SHALL be at least one longer than the length of the GS1 Prefix. The GS1 Company Prefix is issued by a GS1 Member Organisation or by GS1 Global Office, is based on a GS1 Prefix allocated to the issuer, and is allocated either to a GS1 user company or to the issuer itself (e.g., for issuing individual identification keys).

A GS1 Company Prefix starting with a zero ('0') is used to generate GTIN-12s (as well as the other GS1 identification keys). A GS1 Company Prefix starting with a digit other than zero ('0') is used to generate GTIN-13s (as well as the other GS1 identification keys).

 **Note:** As the GS1 Company Prefix varies in length, the issuance of a GS1 Company Prefix excludes all longer strings that start with the same digits from being issued as GS1 Company Prefixes.

1.4.5 U.P.C. Prefix

A U.P.C. Prefix is derived from a GS1 Prefix that starts with zero ('0') by removing that leading zero. A U.P.C. Prefix is:

- used to issue U.P.C. Company Prefixes;
- reserved for Restricted Circulation Numbers; or
- reserved for special functions.

U.P.C. Prefix ranges are shown in figure [1.4.5-1](#).

Figure 1.4.5-1. Synopsis of U.P.C. Prefix ranges

GS1 Prefix range	U.P.C. Prefix range	Significance
0000000	000000	Used to issue Restricted Circulation Numbers within a company
0000001 – 0000099	N/A	Unused to avoid collision with GTIN-8
00001 – 01999	0001 – 1999	Used to issue U.P.C. Company Prefixes
02	2	Used to issue Restricted Circulation Numbers within a geographic region
03	3	Used to issue U.P.C. Company Prefixes, reserved for alignment with FDA Labeler Code
04	4	Used to issue Restricted Circulation Numbers within a company
05	5	Reserved for future use
06 – 09	6 – 9	Used to issue U.P.C. Company Prefixes

1.4.6 U.P.C. Company Prefix

A U.P.C. Company Prefix is derived from a GS1 Company Prefix that starts with zero ('0') by removing that leading zero. A U.P.C. Company Prefix SHALL only be used to construct 12-digit trade item identifiers; see section [2](#) for details.

When a leading zero is added to a U.P.C. Company Prefix, it becomes a GS1 Company Prefix that may be used to issue all other GS1 identification keys.

 **Note:** For example, the 6-digit U.P.C. Company Prefix 614141 is derived from the 7-digit GS1 Company Prefix 0614141.

1.4.7 GS1 identification key

A GS1 identification key is a unique identifier for a class of objects (e.g., trade items) or an instance of an object (e.g., logistic unit).

The type of the GS1 identification key is declared implicitly or explicitly by the data carrier or electronic message in which the key is used.

 **Note:** For example:

- in a barcode, the type is declared by the preceding GS1 Application Identifier (AI);
 - in the case of EAN/UPC and ITF-14 symbologies, the AI (01) is implied;

- in electronic communication (EDI messages, EPCIS, semantic tags, etc.), the type is declared by the underlying schema or specification.

The type defines the syntax (character set and structure) of the value. At minimum, the GS1 identification key value contains one of the following:

- a GS1 Prefix;
- a GS1-8 Prefix (only for GTIN-8);
- a GS1 Company Prefix;
- a U.P.C. Prefix; or
- a U.P.C. Company Prefix (only for GTIN-12).

1.4.8 Character set

The GS1 identification system supports three character sets; the specific character set depends on the identification key type. The three character sets are:

- digit characters ('0' to '9');
- characters from the ISO/IEC 646 Table 1 – Unique graphic character allocations¹, referred to within this standard as GS1 AI encodable character set 82 (see figure 7.11-1); and
- digit characters ('0' to '9'), upper case alphabetic characters ('A' to 'Z'), and three special characters ('#', '-' and '/'), referred to within this standard as GS1 AI encodable character set 39 (see figure 7.11-2).

Regardless of the identification key type, the GS1 Prefix and (if applicable) the GS1 Company Prefix within any identifier use only the digit characters. Some identification key types that have a serial component also support different character sets for the serial component than for the portion that precedes it.

Figure 1.4.8-1. Synopsis of GS1 identification keys

GS1 identification key type	Character set
Global Trade Item Number (GTIN)	Digit characters
Global Location Number (GLN)	Digit characters
Serial Shipping Container Code (SSCC)	Digit characters
Global Returnable Asset Identifier (GRAI)	Digit characters (before serial component) GS1 AI encodable character set 82 (serial component)
Global Individual Asset Identifier (GIAI)	GS1 AI encodable character set 82
Global Service Relation Number (GSRN)	Digit characters
Global Document Type Identifier (GDTI)	Digit characters (before serial component) GS1 AI encodable character set 82 (serial component)
Global Identification Number for Consignment (GINC)	GS1 AI encodable character set 82
Global Shipment Identification Number (GSIN)	Digit characters
Global Coupon Number (GCN)	Digit characters
Component/Part Identifier (CPID)	GS1 AI encodable character set 39
Global Model Number (GMN)	GS1 AI encodable character set 82

As every identifier in the GS1 identification system is a string, even when it is composed only of digit characters, all characters including leading zeroes are significant.

1.5 GS1 identification licensing

A GS1 identification licence, GS1 Company Prefix, or individual GS1 identification key SHALL NOT be sold, leased, or given, in whole or in part, for use by any other company. This applies to:

¹ While the ISO/IEC 646:1991 specification is not publicly available, the 6th edition of ECMA-6 corresponds to it and is available at <https://www.ecma-international.org/publications-and-standards/standards/ecma-6/>

- GS1 Company Prefix licences, including any GS1 identification keys issued from the GS1 Company Prefix
- Individual GS1 identification key licences

See section [1.6](#) for additional guidelines that apply when a company changes legal status as a result of an acquisition, merger, partial purchase, split, or spin-off.

A GS1 Company Prefix licensed from a GS1 Member Organisation entitles the GS1 identification licensee to allocate any of the GS1 identification keys:

- Global Trade Item Number (GTIN)
- Global Location Number (GLN)
- Serial Shipping Container Code (SSCC)
- Global Returnable Asset Identifier (GRAI)
- Global Individual Asset Identifier (GIAI)
- Global Service Relation Number (GSRN)
- Global Document Type Identifier (GDTI)
- Global Shipment Identification Number (GSIN)
- Global Identification Number for Consignment (GINC)
- Global Coupon Number (GCN)
- Component/Part Identifier (CPID)
- Global Model Number (GMN)

An individual GS1 identification key licence SHALL only be used as defined by the licensing GS1 Member Organisation.

 **Note:** If a company holds licences for multiple GS1 Company Prefixes, it may have GS1 identification keys of any type issued from all of them.

1.6 Licence management

GS1 Member Organisations licence GS1 Company Prefixes and in some cases also licence individual GS1 identification keys (e.g., GTINs and GLNs) to companies.

Regardless of whether a GS1 Company Prefix or individual GS1 identification key has been issued by the GS1 Member Organisation, the standards on the use and reuse of GS1 identification keys apply at all times. See section [4](#) for the reuse rules that apply to GS1 identification keys.

Additional guidelines in the following sections apply when an organisation changes legal status due to an acquisition, merger, partial purchase, split, or spin-off.

GS1 Member Organisations may adapt the following guidelines if local laws require modifications.

GS1 identification licensees SHOULD notify their GS1 Member Organisation of any legal status change within one year of that change.

 **Important:** When the company responsible for a GS1 Company Prefix or individual GS1 identification key changes, all parties involved in the transaction SHOULD maintain records of all GS1 identification keys used to identify objects and ensure all GS1 allocation and non-reuse rules are followed.

1.6.1 Acquisitions and mergers

During an acquisition or merger, a company may assume responsibility for the acquired company's GS1 Company Prefix and/or individual GS1 identification key licences. In the situations where the licences transfer, the acquiring company can:

- Use the acquired company's GS1 Company Prefix(es) and GS1 identification key(s)
- Issue GS1 identification keys using the newly acquired GS1 Company Prefix(es)

For example, products that the acquired company identified using its GS1 Company Prefix or individual GS1 identification key licences can still be produced using the same GTINs after the merger. Additionally, parties, locations, assets, and other objects identified with GS1 identification keys can continue to use those keys after the merger.

If a partial purchase occurs, where only a segment of a larger entity is acquired, the involved companies must determine whether GS1 identification licences are transferred based on their specific business requirements.

1.6.2 Split or spin-off

When a company splits into two or more separate companies, it is necessary for each GS1 Company Prefix or individual GS1 identification key licence of the original company to be transferred to only one of the new companies. If a company is left without a GS1 identification licence and has a requirement to identify products, locations, assets, etc., it will need to follow GS1 Member Organisation processes to apply for new GS1 Company Prefixes or individual GS1 identification key licences.

The decision on whether the new companies will take the original licences SHOULD minimise the impact on existing GS1 identification keys. The decision SHOULD be part of the legal arrangements of the new companies.

1.6.3 GS1 identification keys transferred to an acquiring, partial purchase, or spin-off company

If a company is being acquired by, merged or split from another company and has stock on hand, the stock's existing Global Trade Item Numbers (GTINs) SHOULD be kept. Products that are produced after the acquisition or merger may keep the GTIN allocated before the acquisition if the acquiring company maintains the licence with the GS1 Member Organisation to use the applicable GS1 Company Prefix or GS1 identification key.

 **Important:** See section [4](#) for the reuse rules that apply to GS1 identification keys.

1.6.3.1 GS1 identification keys not transferred to acquiring, partial purchase or spin-off company

If a company acquires a portion of another company or splits, but the GS1 Company Prefixes are not transferred, then the receiving company SHOULD change the GS1 identification keys associated with the acquired objects within one year.

It is not necessary for existing stocks of trade items or assets to be re-identified, unless legally required or agreed upon by the companies. However, when any of the acquired, partial purchase, split, or spin-off companies have items that are identified using GS1 identification keys allocated from a GS1 Company Prefix that it no longer holds, the company SHOULD re-identify those items using its own GS1 Company Prefix or GS1 identification key licences when new labelling or packaging is produced. Stakeholders SHOULD be notified well in advance of the changes.

At the earliest opportunity, the acquiring company SHOULD transition to new GS1 identification keys for all identified objects.

 **Note:** The rules concerning the use of the seller's GS1 identification keys SHOULD be taken into consideration when drawing up the purchase contract.

 **Important:** See section [4](#) for the reuse rules that apply to GS1 identification keys.

1.7 Sunrise and sunset dates

Expansion of both the breadth and reach of the GS1 system requires the introduction of new data carrier technologies and messaging techniques. While these are potentially disruptive, their use in GS1 global, open standards requires an agreed date at which they are globally accepted for use. This date is referred to as a sunrise date. Its use is accompanied by associated rules that may be unique to the circumstances. A sunrise date is agreed by users/members and approved by the GS1 Management Board.

Conversely, as a data carrier or messaging standard is no longer cost effective as determined by users and approved by the GS1 Management Board, it may be declared obsolete and removed from the *GS1 General Specifications*. This is termed the sunset date. It is accompanied by associated rules that may be unique to the circumstances.

2 Application standards

2.1 Trade items

2.1.1 Introduction

A trade item is any item (product or service) upon which there is a need to retrieve predefined information and that may be priced, or ordered, or invoiced at any point in any supply chain. This definition covers services and products, from raw materials through to end user products, all of which may have predefined characteristics.

The identification and marking of trade items enable the automation of the point-of-sale (through Price Look Up (PLU) files), of goods receiving, inventory management, automatic re-ordering, sales analysis and a wide range of other business applications.

If the item is of variable measure, the respective measure or price information will often be of critical importance to business applications. Attributes relating to trade items (e.g., dates, lot number) are also available as standardised element strings.

Each trade item that is different from another in design and/or content is allocated a unique identification number, which remains the same as long as it is traded. The same identification number is given to all trade items sharing key characteristics. Such numbers must be treated in their entirety throughout the supply chain.

The serialised identification of trade items, which enables total connectivity of information and communication systems, is achieved through the use of GS1 Application Identifier AI (01) GTIN and AI (21) serial number.

Different standard solutions apply depending on the nature of the item and the scope of the user's applications. The following sections determine the identification and symbol marking rules applicable to a particular trade item.

2.1.1.1 Physical or non-physical trade items

Non-physical trade items are usually called services. Services may be identified with a unique GS1 identification key for use in open trade applications or in restricted distribution environments.

2.1.1.2 Open or restricted distribution

The main benefit of the GS1 system for trade items is that it provides a unique and unambiguous identification number for every trade item, which is applicable worldwide in open environments. In addition, the system provides for other number series that may be exclusively used for restricted distribution (e.g., national use, company internal use). Restricted Circulation Numbers are available to GS1 Member Organisations' members to help them develop solutions applicable within their territory.

2.1.1.3 Fixed or variable measure

Fixed measure trade items are those that are always produced in the same version and composition (e.g., type, size, weight, contents and design). Like a fixed measure trade item, a variable measure trade item is an entity with predefined characteristics, such as the nature of the product or its contents. Unlike a fixed measure trade item, a variable measure trade item has at least one characteristic that varies whilst other characteristics of the trade item remain the same. The variable characteristic may be weight, dimension, number of items contained, or volume information. The complete identification of a variable measure trade item consists of both an identification number and information about the variable data.

2.1.1.4 Types of trade items

Scanning at the retail point-of-sale (POS) is a major application of the GS1 system, and trade items that are intended to cross a point-of-sale are subject to specific rules. Scanning of trade items are broken into four groups based on the application and sector. If a trade item falls within more than

one trade item category (listed below), the most restrictive rules apply, see the appropriate application standard.

- **General retail consumer trade items** are intended to be sold at retail point-of-sale identified with a GTIN-13, GTIN-12 or GTIN-8 utilising omnidirectional linear barcodes. During a transition period, 2D barcodes may be applied in addition to the linear barcode. For information on how to manage multiple barcodes see section [4.15](#). For a summary of all conformance requirements for this AIDC application standard, 2D barcodes, cross-application rules and related technical specifications, see section [8.2](#).
- **Regulated healthcare retail consumer trade items** are sold to the end consumers at a retail point-of-sale outlet (i.e., pharmacies). They are identified with a GTIN-13, GTIN-12 or GTIN-8 utilising linear or GS1 DataMatrix that can be scanned by image-based scanners.
- **Non-retail trade items** are any trade item that does not cross retail POS. Commonly, these trade items will appear in mixed scanning environments (laser, image-based, etc.) depending on the application and industry sector. Typical examples include trade item groupings, direct part marked items, etc.
- **Non-new trade items** are any trade item of the above types that are being made available for sale or use after the first use or consumer purchase (e.g., used, repurposed, refurbished, second life). For rules on identification of these types of trade items, see section [2.1.15](#).



Note: Non-new trade items would not normally include trade items that have been returned in their original packaging for a refund.

2.1.1.5 Books and serial publications

Published material (newspapers, magazines and books) requires special consideration due to the following factors:

- A solution for published material should address the requirement to process returns (sorting and counting) to wholesalers and publishers. This implies the reading of a supplementary number that is not required for item identification.
- The international systems, ISSN, ISBN and ISMN, already handle the numbering of publications and books.

2.1.1.6 Single item or trade item grouping

A trade item may be a single, non-breakable unit or a predefined grouping of a series of single items.

Trade items that are single, non-breakable units may be comprised of items that are not uniquely identified on the package and are not marked for individual sale (e.g., a bag of individually wrapped candies or toothbrushes of varying colours), which were referred to as "Random assortments" in versions of the GS1 General Specifications prior to v.23.

Trade item groupings may be present in a wide variety of physical forms, such as a fibreboard case, a covered or banded pallet, a film wrapped tray, or a crate with bottles. Trade items consisting of a single unit are identified with a Global Trade Item Number (GTIN). Trade item groupings of identical or different units, each identified with a GTIN, are identified with a separate GTIN; the individual trade item GTIN, within any grouping, remains the same. Example: trade item A has the same GTIN whether it is sold as a single unit in a case of twelve or sold as a single unit in a case of twenty-four.

2.1.1.7 Trade item assortments/bundles

Trade item assortments/bundles are combinations of trade items. Trade item assortments/bundles can be classified as follows:

- **Physical trade item assortments/bundles** are combinations of different trade items that are physically combined into a single trade item, thus creating a new trade item.

- ✔ **Note:** Combinations of the same trade items are either trade item groupings for general distribution (see sections [2.1.1.6](#) and [2.1.1.7](#)) or pre-pack/multi-pack/set pack for apparel and home fashion (see section [4.2.4.3.1](#)).
- **Virtual trade item assortments/bundles** are combinations of multiple (same or different) trade items that are not physically combined into a single trade item, but that are presented in selling environments as offers of combinations of multiple trade items (e.g., products or services).
- ✔ **Note:** Across the GS1 General Specifications, there are a number of terms that are used to describe combinations (e.g., “grouping”, “trade item grouping”, “multi-pack”, “trade item assortment/bundle”). Every effort has been made to ensure that these terms are used consistently, noting that some of these terms may have different colloquial meanings when used outside of the GS1 General Specifications.
- ✔ **Note:** This section does not apply to regulated healthcare non-retail consumer trade items dispensed in a controlled environment (e.g., hospital, clinician’s office)
- ✔ **Note:** Creation of trade item assortment/bundles must comply with all regulations and laws.

2.1.1.7.1 Physical trade item assortments/bundles

- **Predefined:** A trade item assortment/bundle that comprises a fixed composition of two or more different trade items, each identified with a GTIN (see section [4.2](#)). The trade items contained within may be trade items of one or more GTIN allocators.

Regardless of the contents of the trade item assortment/bundle, GTIN allocation is the responsibility of the organisation that creates the trade item assortment/bundle. Any change in the configuration is considered a new trade item.

Predefined Fixed composition of two or more trade items. Each trade item within has its own GTIN and could be sold individually.



Example: a predefined assortment/bundle contains a total of three trade items, always one of GTIN A, one of GTIN B and one of GTIN C.

- **Dynamic:** A trade item assortment/bundle that comprises a variable composition of a fixed total count of two or more different trade items, each identified with a GTIN(see section [4.2](#)). All the trade items and their GTINs will have been communicated to the buyer before trading takes place. The buyer has accepted that the GTIN allocator may change the trade item assortment/bundle without any prior notice.

The trade items contained within the trade item assortment/bundle may be trade items of one or more GTIN allocators. Regardless of the contents, GTIN allocation for the trade item assortment/bundle is the responsibility of the organisation that creates the trade item assortment/bundle.

Dynamic There is a defined pool of trade items that may be in the trade item assortment/bundle. The quantity of each trade item in any instance of the trade item assortment/bundle is not guaranteed, but total number of trade items does not change. Each trade item within the assortment has its own GTIN and could be sold individually.



Example: a dynamic assortment/bundle could contain any three trade items with three different GTINs, each from a pool of trade items that have been defined for use in the dynamic trade item assortment/bundle, as long as there are always three trade items within the trade item assortment/bundle.

2.1.1.7.2 Virtual trade item assortment/bundle

Virtual trade item assortment/bundle: A combination of multiple (same or different) trade items that are NOT physically combined into a single trade item. Virtual trade item assortments/bundles are most often related to the listing/selling practice of virtually combining multiple trade items into a number of offers for sale, typically in online environments. Each individual trade item within a virtual trade item assortment/bundle SHALL be identified with a GTIN (see section 4.2). The virtual trade item assortment/bundle itself does not require assignment of a GTIN, as it is not a physical combination of trade items and is not itself a new trade item.

Note: Virtual trade item assortments/bundles are not stocked as single trade items. Sales of virtual trade item assortments/bundles are fulfilled by assembling the purchased quantity of each individual trade item at the time of order fulfilment.

Figure 2.1.1.7.2-1 Trade item assortment/bundle summary

	Assortment/bundle type	Graphic	Assortment GTIN? (Y/N)	Item mix: fixed/variied	Physically combined together? (Y/N)	Item GTINs? (Y/N)
Physical	<p>Predefined</p> <p>A trade item assortment/bundle that comprises a fixed composition of two or more different trade items, each identified with a GTIN</p>		Y	Fixed	Y	Y
	<p>Dynamic</p> <p>A trade item assortment/bundle that comprises a variable composition of a fixed total count of two or more different trade items, each identified with a GTIN</p>		Y	Varied	Y	Y

	Assortment/bundle type	Graphic	Assortment GTIN? (Y/N)	Item mix: fixed/variable	Physically combined together? (Y/N)	Item GTINs? (Y/N)
Virtual	A combination of multiple trade items that are NOT physically combined into a single trade item.		N	Fixed	N	Y

2.1.1.8 Regulated healthcare trade items (RHTI)

Regulated healthcare trade items (RHTI) are pharmaceutical or medical device trade items that are sold or dispensed in a controlled environment such as in a retail pharmacy, hospital pharmacy, etc.

2.1.1.8.1 Marking levels of regulated healthcare trade items

For regulated healthcare trade items (RHTI) three levels of identification have been developed:

- Minimum level of AIDC marking.
- Enhanced level of AIDC marking.
- Highest level of AIDC marking.

The identification solution for each of these levels may differ between the category of “pharmaceuticals” (which includes biologics, vaccines, controlled substances, clinical trial pharmaceuticals and therapeutic nutritional products) versus the category of “medical devices” (which includes all classes of medical devices) and may also differ by configuration or packaging level (trade items direct marked, primary packaging, secondary packaging, case/shipper, pallet, logistics unit).

The standards in section [2.1.6](#) define the data required by packaging level and by product type. For purposes of AIDC marking, the brand owner is responsible for determining the proper assignment of each regulated healthcare retail consumer trade item to either the pharmaceutical or medical device category in accordance with local regulatory requirements. Additionally, within some use cases, or under the requirement of some regulations, certain medical devices will require direct part marking (DPM) of the AIDC data carrier. For more details on the application of DPM with medical devices see section [2.1.8](#).

2.1.1.8.2 National Healthcare Reimbursement Numbers

National Healthcare Reimbursement Number (NHRN) is the term for identification numbers used on pharmaceutical and/or medical devices, where required by national or regional regulatory organisations, for product registration purposes and/or for the management of reimbursement. For compliance with a national/regional regulatory or industry requirement where the GTIN will not meet the current need, the trade item SHALL be identified with GTIN and the applicable GS1 Application Identifier for NHRN.

See sections [2.1.5](#), [2.1.6](#) and [3.8.19](#) for a complete description of the structure and rules of use of the GS1 Application Identifier for NHRN.

2.1.1.9 Single trade items composed of several physical parts

Because of its physical nature, a trade item may be packed in separate physical parcels. For example, furniture equipment may be composed of several pieces (e.g., a sofa and two armchairs, which cannot be ordered or sold separately). A specific standard solution is available to identify and symbol mark each component of a trade item composed of several physical parts.

2.1.1.10 GTIN data string

A GTIN may be an eight, twelve, thirteen or fourteen-digit string. These strings will be unique when they incorporate a GS1 Company Prefix, U.P.C. Company Prefix or GS1-8 Prefix as required and if they are always treated as a data string of digits plus a final check digit. The check digit is explained in section 7.9. Its verification ensures that the number is correctly composed.

Figure 2.1.1.10-1. Overview of GTIN formats

GTIN Formats														
←-----→														
(GTIN-8)							N ₁	N ₂	N ₃	N ₄	N ₅	N ₆	N ₇	N ₈
(GTIN-12)			N ₁	N ₂	N ₃	N ₄	N ₅	N ₆	N ₇	N ₈	N ₉	N ₁₀	N ₁₁	N ₁₂
(GTIN-13)		N ₁	N ₂	N ₃	N ₄	N ₅	N ₆	N ₇	N ₈	N ₉	N ₁₀	N ₁₁	N ₁₂	N ₁₃
(GTIN-14)	N ₁	N ₂	N ₃	N ₄	N ₅	N ₆	N ₇	N ₈	N ₉	N ₁₀	N ₁₁	N ₁₂	N ₁₃	N ₁₄

When any of these GTINs is encoded in a data carrier that must encode a fixed-length data string of 14-digits, the GTINs less than 14-digits in length must be prefixed by leading zeroes that simply act as filler digits.

Figure 2.1.1.10-2. 14-digit representation of the four GTIN formats

added zero(es) right aligned GTIN string														
←-----→														
(GTIN-8)	0	0	0	0	0	0	N ₁	N ₂	N ₃	N ₄	N ₅	N ₆	N ₇	N ₈
(GTIN-12)	0	0	N ₁	N ₂	N ₃	N ₄	N ₅	N ₆	N ₇	N ₈	N ₉	N ₁₀	N ₁₁	N ₁₂
(GTIN-13)	0	N ₁	N ₂	N ₃	N ₄	N ₅	N ₆	N ₇	N ₈	N ₉	N ₁₀	N ₁₁	N ₁₂	N ₁₃
(GTIN-14)	N ₁	N ₂	N ₃	N ₄	N ₅	N ₆	N ₇	N ₈	N ₉	N ₁₀	N ₁₁	N ₁₂	N ₁₃	N ₁₄

The presence or lack of these leading zeroes does not change the GTIN concerned.

- 
Note: GTINs may be stored with or without leading zeroes in the same database field, depending on the requirements of the particular application.

- 
Note: A GTIN-12 may start with one, two or three leading zeroes. These zeroes are meaningful since they are part of the U.P.C. Company prefix, and therefore these must be preserved when storing the GTIN-12 in a database field. For the list of U.P.C. Prefix ranges see section 1.4.

2.1.2 Fixed measure trade items – open supply chain

Fixed measure trade items are those that are always produced in the same version and composition (e.g., type, size, weight, contents, design). The identification number identifies the item unambiguously. Every trade item that is different from another in any respect is assigned a separate Global Trade Item Number (GTIN).

2.1.3 Fixed measure trade items scanned at retail POS

A fixed measure consumer trade item that is intended to be read at retail point-of-sale (POS) SHALL be identified with a GTIN-8, GTIN-12, or GTIN-13. It SHALL carry a barcode from the EAN/UPC family or the GS1 DataBar® retail POS family. During a transition period, 2D barcodes may be applied in addition to the linear barcode. For information on how to manage multiple barcodes see section 4.15. For a summary of all conformance requirements for this AIDC application standard, 2D barcodes, cross-application rules and related technical specifications, see section 8.2

2.1.3.1 Fixed measure trade items scanned at retail POS using GTIN-12 or GTIN-13

Application description

Figure 2.1.3.1-1. GTIN-12/GTIN-13 data structure

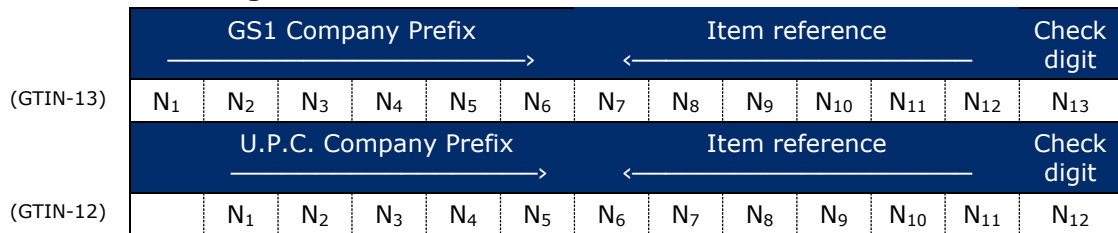

The GS1 Company Prefix is allocated by a GS1 Member Organisation to a system user. It makes the ID number unique worldwide but does not identify the origin of the item. Any valid GS1 Company Prefix, other than ones starting with a zero, may be used to issue a GTIN-13 and any valid U.P.C Company Prefix may be used to issue a GTIN-12. The GS1 Prefixes used for this purpose can be found in section [1.4](#).

The item reference is assigned by the system user, who must observe the rules in section [4](#).

The check digit is explained in section [7.9](#). Its verification, carried out automatically by the barcode reader, ensures that the number is correctly composed.

GS1 key

Required

The allowed key formats for this application are:

- GTIN-12
- GTIN-13

Rules

All the GTIN rules described in section [4](#).

Attributes

Required

Not applicable

Optional

For all the GS1 Application Identifiers (AI) that can be used with a GTIN, see section [3](#).

Rules

Not applicable

Data carrier specification

Carrier choices

The data carriers for this element string are:

- UPC-A barcode (carrying a GTIN-12).
- EAN-13 barcode (carrying a GTIN-13).
- GS1 DataBar Retail POS family (carrying GTIN-12 or GTIN-13 represented in a fixed-length data string of 14 digits by adding leading zeroes).

- 
Note: During a transition period, 2D barcodes may be applied in addition to the linear barcode. For a summary of all conformance requirements for this AIDC application standard, 2D barcodes, cross-application rules and related technical specifications, see section [8.2](#).

Symbol X-dimensions, minimum symbol height and minimum symbol quality

See section [5.12.3.1](#), *GS1 symbol specification table 1*.

Symbol placement

All the symbol placement guidelines are defined in section [6](#).

Unique application processing requirements

For a description of processing requirements, see section [7](#).

2.1.3.2 Fixed measure trade items scanned at retail POS using GTIN-12 carried by a UPC-E barcode

Application description

Some GTIN-12s beginning with the U.P.C. Prefix 0 may be represented in a small symbol called the UPC-E barcode. The GTIN-12 is condensed into a barcode consisting of six symbol character positions. For application processing, the GTIN-12 must be transformed into its full length by the barcode reader software or by the application software. There is no six-digit UPC-E barcode. See section [7.10](#) for UPC-E barcode options.

GS1 key

Required

- 
 GTIN-12

Rules

All the GTIN rules described in section [4](#).

Attributes

Not applicable

Data carrier specification

Carrier choices

- 
 UPC-E (carrying a GTIN-12 in six explicitly encoded digits using zero-suppression techniques).

- 
Note: During a transition period, 2D barcodes may be applied in addition to the linear barcode. For a summary of all conformance requirements for this AIDC application standard, 2D barcodes, cross-application rules and related technical specifications, see section [8.2](#).

Symbol X-dimensions, minimum symbol height and minimum symbol quality

See section [5.12.3.1](#), *GS1 symbol specification table 1*.

Symbol placement

All the symbol placement guidelines defined in section [6](#).

Unique application processing requirements

For a description of processing requirements, see section [7](#).

2.1.3.3 Fixed measure trade items scanned at retail POS using GTIN-8

Application description

The GTIN-8 is available for items whose packaging does not include enough available space to permit the use of an EAN-13 symbol. GTIN-8s are individually assigned by GS1 Member Organisations on request. figure [2.1.3.3-1](#) shows the data structure of a GTIN-8.

Figure 2.1.3.3-1. GTIN-8 data structure

GS1-8 Prefix			Item reference				Check digit
N ₁	N ₂	N ₃	N ₄	N ₅	N ₆	N ₇	N ₈

The GS1-8 Prefix is a unique string of two or more digits issued by GS1 Global Office. See section [1.4.3](#) for the GS1-8 Prefixes used in this element string.

The item reference is assigned by the GS1 Member Organisation. The GS1 Member Organisations provide procedures for obtaining GTIN-8s.

The check digit is explained in section [7.9](#). Its verification, carried out automatically by the barcode reader, ensures that the number is correctly composed.

GS1 key

Required

- GTIN-8

Rules

All the GTIN rules described in section [4](#).

Attributes

Required

Not applicable

Optional

For all the GS1 Application Identifiers (AI) that can be used with a GTIN, see section [3](#).

Rules

Not applicable

Data carrier specification

Carrier choices

- EAN-8 (carrying a GTIN-8).
- GS1 DataBar Retail POS family (carrying a GTIN-8).



Note: During a transition period, 2D barcodes may be applied in addition to the linear barcode. For a summary of all conformance requirements for this AIDC application standard, 2D barcodes, cross-application rules and related technical specifications, see section [8.2](#).

Symbol X-dimensions, minimum symbol height and minimum symbol quality

See section [5.12.3.1](#), GS1 symbol specification table 1.

Symbol placement

All the symbol placement guidelines defined in section [6](#).

Unique application processing requirements

For a description of processing requirements, see section [7](#).

2.1.3.4 Hardcover books and paperbacks scanned at retail POS using ISBN, GTIN-13, or GTIN-12**Application description**

When identifying books and paperbacks a company may identify them in the same manner as any other retail trade items (see section [2.1.3](#)). However, the recommended option is to use the International Standard Book Number (ISBN numbering system). The GS1 Prefixes 978 and 979² have been allocated to ISBN (<http://www.isbn-international.org/>), which allocates numbers from these 'Bookland' prefixes.



Note: ISBNs SHALL NOT be allocated to non-book products even if the products are related to a book (e.g., teddy bears, coffee mugs, T-shirts, etc. related to a book launch). Such non-book products SHALL be identified and barcoded in the same manner as any other retail trade item (see section [2.1.3](#)). A trade item grouping of identical book items would normally be identified according to section [2.1.7.2](#). However, an ISBN may also be used to create a 14-digit GTIN with an indicator to identify a trade item grouping of identical book items (refer to section [2.1.7.2](#)) provided that the publisher that issues the 14-digit GTIN is a member of a GS1 organisation or is authorised to act through an agreement between its local GS1 Member Organisation and the local organisation representing publishers.

GS1 key**Required**

The allowed key formats for this application are:

- ISBN using GS1 Prefix 978 or 979
- GTIN-12
- GTIN-13

Rules

All the GTIN rules described in section [4](#).

Attributes**Required**

Not applicable

Optional

Some publishers may wish to communicate additional information in a barcode in order to meet their internal requirements. For example, publishers may wish to include an edition variant (e.g., unchanged reprint, price increase), which is not distinguished by the ISBN, GTIN-13, or GTIN-12.

² Within GS1 Prefix 979 a subset 9790 has been allocated to the International ISMN Agency for notated music.

The GS1 system provides an additional two- or five-digit symbol, called an add-on symbol that can be included on the item just to the right of the main symbol.

A two-digit or five-digit add-on number provides more information about a particular publication of the printed item, but it is not required for the identification of the title itself.

This figure shows the format of a two-digit add-on:

Figure 2.1.3.4-1. Two-digit add-on format

Supplementary information	
N ₁	N ₂

The supplementary information consists of numeric data of any structure and meaning. It is the publisher's responsibility to define the numbering scheme. The data carrier for this element string is the two-digit add-on symbol.

The system recognises this element string by the symbology identifier **JE1**. The two-digit add-on symbol must be jointly used with a UPC-A, UPC-E or EAN-13 barcode. It is never scanned alone, and the data from both barcodes can be used together for processing.

This figure shows the format of a five-digit add-on:

Figure 2.1.3.4-2. Five-digit add-on format

Supplementary information				
N ₁	N ₂	N ₃	N ₄	N ₅

The supplementary information consists of numeric data of any structure and meaning. It is the publisher's responsibility to define the numbering scheme. The data carrier for this element string is the five-digit add-on symbol.

The system recognises this element string by the symbology identifier **JE2**. The five-digit add-on symbol must be jointly used with a UPC-A, UPC-E or EAN-13 barcode. It is never scanned alone, and the data from both barcodes can be used together for processing.

Rules

Add-on symbols involve the following constraints:

- They SHOULD NOT contain information that should rightly be looked up using the item's GTIN-13 (or GTIN-12).
- The reading of the add-on symbol by the retailer's point-of-sale system is optional.
- The use of the add-on symbol is the responsibility of each publisher.

Data carrier specification

Carrier choices

Individual books and paperbacks SHOULD be marked with an EAN-13, UPC-A, or UPC-E barcode that complies with the print quality specifications applicable to all GS1 system barcodes. The EAN/UPC 2-digit or 5-digit Add-on symbols are options used with the above EAN/UPC symbols.

Groupings of identical book items and paperbacks SHOULD be marked with GS1-128 or ITF-14, see section [2.1.7.2](#).

 **Note:** When identifying serial publications, see section [2.1.3.5](#).

Symbol X-dimensions, minimum symbol height and minimum symbol quality

See section [5.12.3.1](#), *GS1 symbol specification table 1*.

Symbol placement

All the symbol placement guidelines defined in section [6.4](#).

Unique application processing requirements

For description of processing requirements, see section [7](#).

2.1.3.5 Serial publications scanned at retail POS using ISSN, GTIN-13, or GTIN-12

Application description

The first and recommended option is to make use of the International Standard Serial Number (ISSN) system. The GS1 Prefix 977 is used for encoding the ISSN assigned to a particular item without its check digit.

The second option is to identify serial publications in the same manner as any other trade item: using the GTIN-13 or GTIN-12 data structure.

The third option involves using a special GS1 Company Prefix (assigned by a GS1 Member Organisation within its territory), the publication number and the price of the publication (provided that the national legislation allows this). With this option, the price is placed in clearly defined positions and is directly usable in the country of publication. However, as soon as the item leaves the country, the price has no direct significance, and the GTIN must be interpreted in a general way without being broken down internally.

Figure 2.1.3.5-1. Format of the element string

GS1 Prefix	ISSN (without its check digit)	Variant	Check digit
9 7 7	N ₄ N ₅ N ₆ N ₇ N ₈ N ₉ N ₁₀	N ₁₁ N ₁₂	N ₁₃

The variant digits N₁₁ and N₁₂ may be used to express variants of the same title for issues with a different price or to identify different issues of a daily within one week. Normal title takes value 00.

GS1 key

Required

The allowed key formats for this application are:

- ISSN using GS1 Prefix 977
- GTIN-12
- GTIN-13

Rules

All the GTIN rules described in section [4](#).

Attributes

Required

Not applicable

Optional

Some publishers may wish to communicate additional information in a barcode in order to meet their internal requirements.

A two-digit or five-digit add-on number provides more information about a particular publication of the printed item, but it is not required for the identification of the title itself.

This figure shows the format of a two-digit add-on:

Figure 2.1.3.5-2. Two-digit add-on format

Supplementary information	
N ₁	N ₂

GS1 recommends the use of the following number assignment:

- Dailies (or more generally publications with several issues a week): The publications of each day of the week are considered separate trade items that must be identified with a separate identification number represented in an EAN-13, UPC-A, or UPC-E symbol. The two-digit add-on number should only be used to represent the applicable week, which, together with the GTIN-13 or GTIN-12, establishes the day within the year.
- Weeklies: Number of the week (01 – 53).
- Bi-weeklies: Number of the first week of the respective period (01 – 53).
- Monthlies: Number of the month (01 – 12).
- Bi-monthlies: Number of the first month of the respective period (01 – 12).
- Quarterlies: Number of the first month of the respective period (01 – 12).
- Seasonal period: First digit = last digit of the year; second digit = 1 spring, 2 summer, 3 autumn, 4 winter.
- Bi-annual period: First digit = last digit of the year; second digit = number of the first season of the respective period.
- Annuals: First digit = last digit of the year; second digit = 5.
- Special intervals: Consecutively numbered from 01 to 99.

The add-on number is carried by a two-digit add-on symbol that is placed to the right of the symbol and parallel to it. The add-on symbol must comply with the print quality specifications applicable to all GS1 system barcodes. For example, the X-dimension applied to the main barcode must also be applied to the add-on symbol.

Serial publications can also use a five-digit add-on number carried by a five-digit add-on symbol. The reading of the add-on symbol at a point-of-sale is optional. The add-on symbol must not be used to encode information that should be contained within the Global Trade Item Number (GTIN). The add-on symbol provides additional information about a particular publication of a printed item, and it is the publisher’s responsibility to define the numbering scheme. This figure shows the format of a five-digit add-on:

Figure 2.1.3.5-3. Five-digit add-on format

Supplementary information				
N ₁	N ₂	N ₃	N ₄	N ₅

Information that can be encoded in the five-digit add-on symbol includes the actual date of issue, in order to differentiate between successive issues.

The five-digit add-on symbol is placed to the right of the main symbol and parallel to it. The add-on symbol must comply with the print quality specifications applicable to all GS1 system barcodes. For example, the X-dimension applied to the main symbol also must be applied to the add-on symbol.

Rules

When using a five-digit add-on symbol, a two-digit add-on symbol cannot also be used.

Data carrier specification

Carrier choices

Serial Publications SHOULD be marked with an EAN-13, UPC-A, or UPC-E barcode that complies with the print quality specifications applicable to all GS1 system barcodes. The EAN/UPC two-digit or five-digit add-on symbols are options used with the above EAN/UPC symbols.

Symbol X-dimensions, minimum symbol height and minimum symbol quality

See section [5.12.3.1](#), GS1 symbol specification table 1.

Symbol placement

All the symbol placement guidelines defined in section [6.4](#).

Unique application processing requirements

For a description of processing requirements, see section [7](#).

2.1.3.6 Fixed measure fresh food trade items scanned at retail POS**Application description**

Fresh foods includes product categories such as: fruits, vegetables, meat, seafood, bakery and ready-to-serve food such as cheeses, cold cooked or cured meats and salad, etc.

In this application there are different scenarios:

- Loose produce: Picked as an each – sold as an each.
- Fresh food: Pre-packed with same weight or count.

Loose produce trade items sold as an each

Loose produce are fruits and vegetables which are delivered to the store loose, in boxes or cases. Loose produce can then be displayed on the shelf allowing for the consumer to pick the product quantities needed. If loose produce has been defined to be sold by the each then they are treated in the same way as the retailer sells a can of soup or beans.

From a brand owner's perspective, the trade item is a fixed measure trade item identified with a GTIN with no additional attributes necessary to complete transaction.

Pre-packed fresh food trade items

When fresh foods trade items, whether loose produce or cut from a bulk item or cut into pieces are pre-packaged as a fixed measure trade item then the trade item is also treated like any other fixed measure trade item identified with a GTIN with no additional attributes necessary to complete transaction.

GS1 key**Required**

The allowed key formats for this application are:

- GTIN-8
- GTIN-12
- GTIN-13

Rules

All the GTIN rules described in section [4](#).

Attributes**Required**

Not applicable

Optional

For all the GS1 Application Identifiers (AI) that can be used with a GTIN, see section [3](#).

Rules

Not applicable.

Data carrier specification**Carrier choices**

The data carriers for this element string are:

- UPC-A barcode (carrying a GTIN-12)
- EAN-8 barcode (carrying GTIN-8)
- EAN-13 barcode (carrying a GTIN-13)
- GS1 DataBar Retail POS family (carrying GTIN-12 or GTIN-13)

The GS1 DataBar symbols encode a 14-digit numeric string. When encoding GTIN-8, GTIN-12 or GTIN-13 in GS1 DataBar symbols zero-fill with six, two, or one zeroes to the left of the GTIN.

Symbol X-dimensions, minimum symbol height and minimum symbol quality

See section [5.12.3.1](#), *GS1 symbol specification table 1*.

Symbol placement

There are no specified rules for symbol placement on loose produce scanned at POS.

Unique application processing requirements

Not applicable

2.1.4 Fixed measure trade items scanned in general distribution and at retail POS

Trade items intended for general distribution and retail point-of-sale scanning SHALL carry a barcode from the EAN/UPC or GS1 DataBar retail POS family.

These trade items SHALL be identified with GTIN-8, GTIN-12 or GTIN-13 (see section [2.1.3](#)). For symbol X-dimensions, minimum symbol height and minimum symbol quality, see section [5.12.3.3](#), *GS1 symbol specification table 3*. During a transition period, 2D barcodes may be applied in addition to the linear barcode. For information on how to manage multiple barcodes see section [4.15](#). For a summary of all conformance requirements for this AIDC application standard, 2D barcodes, cross-application rules and related technical specifications, see section [8.3](#).



Note: Allocation of GTIN-8 to new trade items for this application SHALL conform to section [4.2.7](#)

2.1.5 Healthcare primary packaging (non-retail trade items)**Application description**

Healthcare primary packaging trade items are pharmaceutical and medical products or their packages presented to support the point-of-care (direct consumption based on right product, dose and route of administration). Because the product is never scanned at retail POS, the use of symbologies beyond EAN/UPC and the use of GTIN-14 data structure is permitted.

These products, which may be packaged in a sterile packaging system or in a non-sterile packaging system, are only marked when the package is intended for dispensing to the consumer in a hospital or equivalent facility (e.g., field hospital, nursing home, home healthcare).

See section [4.15.1](#) *Multiple barcode management practices for consumer trade items – all sectors* and section [4.15.3](#) *Multiple barcode management practices for healthcare* if the product is intended for scanning at general retail and also must meet regulatory requirements for this application section based on multiple market use. If an item is a regulated healthcare retail consumer trade

item and also a non-retail trade item then the barcode marking for regulated healthcare retail consumer trade items is required at a minimum.

GS1 key

Required

The allowed key formats for this application are:

- GTIN-8
- GTIN-12
- GTIN-13
- GTIN-14

Rules

All the GTIN rules described in section 4.

If the regulated healthcare retail consumer trade item to be marked on the primary packaging does not also have secondary packaging, then the primary packaging markings in this section do not apply and are replaced by the required markings in the secondary packaging section (2.1.6).

Example: a bottle of 50 pharmaceutical tablets (the primary package) is not enclosed into a carton (which would represent the secondary packaging). In this instance, the secondary packaging markings are required on the primary packaging level.

If the required AIDC marks are placed directly on the part, then those AIDC marks (e.g., barcode, human readable interpretation) satisfy the requirements for primary package marking. If those marks are functional (scannable) through the primary packaging, then no additional AIDC marks are required on the primary package.

If the product to be marked has primary packaging that is a blister pack containing several individual pharmaceutical items, for instance a blister pack of 12 pills or tablets, the following rules apply:

- GTIN is the only required mark.
- In addition to the GTIN rules described in section 4, see section 4.2.7 for rules on deploying GTIN-8.

Attributes

Required

Figure 2.1.5-1. Overview of required attributes

AIDC marking level for regulated healthcare trade items	Key	Batch/lot number - AI (10)	Expiration date - AI (17)	Serial number - AI (21)	Other
Minimum (pharmaceutical only)	GTIN-8, GTIN-12, GTIN-13, or GTIN-14	No	No	No	None
Enhanced (med device only)	GTIN-8, GTIN-12, GTIN-13, or GTIN-14	Yes	Yes	No	None
Highest – pharmaceutical brand owner AIDC marking	GTIN-8, GTIN-12, GTIN-13, or GTIN-14	No	No	No	None
Highest – medical device - brand owner AIDC marking	GTIN-8, GTIN-12, GTIN-13, or GTIN-14	Yes	Yes	Yes	Active potency, AI (7004), for kits with pharmaceuticals

AIDC marking level for regulated healthcare trade items	Key	Batch/lot number - AI (10)	Expiration date – AI (17)	Serial number – AI (21)	Other
Highest – hospital AIDC marking of pharmaceutical	GTIN-8, GTIN -12, GTIN -13, or GTIN -14	No	Yes, Expiration date and time, AI (7003), if needed for short life items	Yes	None
Highest – hospital AIDC marking of certain medical devices (see section 2.1.8)	GRAI, AI (8003), or GIAI, AI (8004), is optional if GTIN, AI (01), + serial number, AI (21), is not marked on the product.	No	No	GRAI, AI (8003), or GIAI, AI (8004), is optional if GTIN, AI (01), + serial number, AI (21), is not marked on the product.	

To manage healthcare data requirements within GS1 EPC/RFID tags, see section [3.11](#) and the most recent version of the [EPC Tag Data Standard](#).

Optional

For compliance with a national/regional regulatory or industry requirement where the GTIN will not meet the need, a regulated healthcare trade item may be identified with GTIN and AI (710), AI (711), AI (712), AI (713), AI (714), AI (715) and AI (716) National Healthcare Reimbursement Number, see section [3.8.19](#).

Rules

All the GTIN rules described in section [4](#).

National Healthcare Reimbursement Number AI (710), AI (711), AI (712), AI (713), AI (714) AI (715) and AI (716) must always be used with the GTIN.

Human readable interpretation

For human readable interpretation rules see section [4.14](#). For HRI rules specific to regulated healthcare retail consumer trade items, see section [4.14.1](#).

Data carrier specification

Carrier choices

Figure 2.1.5-2. Carrier choices

Preferred option(s) (this is the long-term direction for AIDC marking)	GS1 DataMatrix symbology GS1-128 symbology GS1 DataBar symbology NOTE: If a product package serves multiple markets and in one market the specifications in section 2.1.3 apply, then the specification for 2.1.3 must be followed for encoding GTIN (at a minimum) and the rules for use of multiple symbols in section 4.15 apply.
Option in addition to the barcode	EPC/RFID tag. GS1 expects the barcode as the minimum requirement for packaging however EPC/RFID is an approved AIDC carrier which can be deployed in addition to the barcode.
Other acceptable options (GS1 strongly supports existing options for symbol marking as a	The following symbols have been permitted by GS1 and therefore could appear on some existing packages. For that reason, GS1 does not want to preclude them as an option, particularly where GTIN without additional data (Minimum ID)

guiding principle and therefore supports all previous AIDC marking specifications)	<p>is required. With that said, symbols that allow all the data to be concatenated into one symbol are the preferred option.</p> <p>EAN/UPC symbology family (UPC-A, UPC-E, EAN-8 and EAN-13) may be used to encode the GTIN-8, GTIN-12 or GTIN-13 Identification. ITF-14 symbols may be used where printing conditions require the application of a less demanding symbology. It may not be used when attribute information is required. ITF-14 symbols can encode the GTIN-8, GTIN-12, GTIN-13, or GTIN-14 of the item. It is not used to encode attribute information.</p> <p>GS1 Composite Component is also used in combination with linear symbols by GS1 and therefore remains a legitimate option however, GS1 DataMatrix is preferred based on its ability to encode all information in one symbol and do so efficiently in terms of print speed and panel size.</p>
---	---

Symbol X-dimensions, minimum symbol height and minimum symbol quality

See section [5.12.3.6](#), GS1 symbol specification table 6.

Symbol placement

All the symbol placement guidelines defined in section [6](#).

Unique application processing requirements

For a description of processing requirements, see section [7](#).

2.1.6 Healthcare secondary packaging (regulated healthcare retail consumer trade items)

A regulated healthcare retail consumer trade item not intended to be scanned in high volumes per consumer transaction at retail, but does require additional data beyond GTIN to support regulatory requirements. This means, these trade items support:

- GTIN-8, GTIN-12, or GTIN-13 data structures.
- GTIN attributes such as batch/lot number, expiration dates, or serial numbers.

They may be marked with GS1 DataMatrix that require imaging-based scanners or linear symbologies such as GS1 DataBar or GS1-128. If an item is a general retail consumer trade item and regulated healthcare retail consumer trade item, then the barcode marking for general retail is required at a minimum.

GS1 key

Required

The allowed key formats for this application are:

- GTIN-8
- GTIN-12
- GTIN-13

GS1 firmly endorses the use of GTIN in all markets, however there are instances where GS1 Member Organisations have allocated a portion of their numbering capacity to identification schemes administered nationally by external agencies.

These coding schemes while recognised within the GS1 system framework by the assignment of a GS1 Prefix are defined, in Healthcare, as National Trade Items Numbers (NTINs) rather than Global Trade item Numbers (GTINs). NTINs are unique with respect to GTINs as their values are a subset of all possible values of GTIN. However, their definition, allocation and life cycle rules are defined by an organisation external to GS1.

The degree to which NTIN definitions and rules are compatible with those of GTIN is specific to each national definition. Whilst NTIN will always provide globally unique identification within the GTIN pool of numbers, this does not mean NTIN provides the same level of interoperability as GTIN with other GS1 standards, such as GDSN and ONS. In markets where NTIN is adopted exclusively of GTIN, the reciprocal nature of GTIN identification and marking across markets is lost and becomes problematic where one package which should serve multiple markets (e.g., common language) requires multiple NTINs rather than one GTIN.

Rules

See the GTIN rules in section [4.2](#).

Attributes

Required

Figure 2.1.6-1. Overview of required attributes

AIDC marking level for regulated healthcare trade items	Key	Batch/lot number - AI (10)	Expiration date - AI (17)	Serial number - AI (21)	Other
Minimum - Pharmaceutical & medical device	GTIN-8, GTIN-12, or GTIN-13	No	No	No	None
Enhanced - Pharmaceutical & medical device	GTIN-8, GTIN-12, or GTIN-13	Yes	Yes	No	None

AIDC marking level for regulated healthcare trade items	Key	Batch/lot number - AI (10)	Expiration date - AI (17)	Serial number - AI (21)	Other
Highest – Brand owner AIDC marking	GTIN-8, GTIN-12, or GTIN-13	Yes	Yes	Yes	Potency AI (7004) (for pharmaceutical, and for medical device kits with pharmaceuticals)
Highest – Hospital AIDC marking of pharmaceuticals	GTIN-8, GTIN-12, or GTIN-13	No	Yes, AI (7003) if needed for short life items	Yes	None
Highest - Hospital AIDC marking of certain medical devices (see section 2.1.8)	GRAI, AI (8003), or GIAI, AI (8004), is optional if GTIN, AI (01), + serial number, AI (21), is not marked on the product.	No	No	GRAI, AI (8003), or GIAI, AI (8004), is optional if GTIN, AI (01), + serial number, AI (21), is not marked on the product.	

To manage healthcare data requirements within EPC/RFID tags, see section [3.11](#) and the most recent version of the [EPC Tag Data Standard](#).

Optional

For compliance with a national/regional regulatory or industry requirement where the GTIN will not meet the need, a regulated healthcare trade item may be identified with GTIN and AI (710), AI (711), AI (712), AI (713), AI (714), AI (715) and AI (716) National Healthcare Reimbursement Number. See section [3.8.19](#) for details on the use of AI (710), AI (711), AI (712), AI (713), AI (714), AI (715) and AI (716).

Rules

National Healthcare Reimbursement Number AI (710), AI (711), AI (712), AI (713), AI (714), AI (715) and AI (716) must always be used with the GTIN.

Data carrier specification

Carrier choices

See the “data carrier specification carrier choices” recommendations on preferred options, options in addition to the barcode and other acceptable options found at the end of section [2.1.5](#).

Symbol X-dimensions, minimum symbol height and minimum symbol quality

For regulated healthcare consumer trade items scanned in retail pharmacy and general distribution or non-retail pharmacy and general distribution see section [5.12.3.8](#), *GS1 symbol specification table 8*.

For regulated healthcare retail consumer trade items not scanned in general distribution see section [5.12.3.10](#), *GS1 symbol specification table 10*.

Symbol placement

All the symbol placement guidelines defined in section [6](#).

Unique application processing requirements

For a description of processing requirements, see section [7](#).

2.1.7 Fixed measure trade items scanned in general distribution

Every trade item that is different from another in any respect is assigned a unique Global Trade Item Number (GTIN). This includes trade item groupings of retail and non-retail trade items that are also trade items, and non-retail single units. For example, each of the packaging types in the figure below, if traded, is assigned a separate GTIN.

Figure 2.1.7-1. Example of GTIN numbering options

Trade item	GTIN numbering options			
	GTIN-8	GTIN-12	GTIN-13	GTIN-14
Single product A	X	X	X	
50 x product A (Trade item grouping)		X	X	X
50 x product A (Trade item grouping, e.g., display case)		X	X	X
100 x product A (Trade item grouping)		X	X	X
Single product B	X	X	X	
50 x product A 50 x product B		X	X	

If, at any time, the trade item is shipped or transported as an independent logistic unit, at the time of shipment it SHOULD additionally be identified with an SSCC. The combination of a GTIN and a serial number (also known as SGTIN) does not replace the SSCC as the identifier of a logistic unit.

If, in addition to the item being identified by GTIN, the item also has a product model, then this product model is identified with a Global Model Number (GMN). See section [2.6.13](#) for the application standard on GMN.

2.1.7.1 Identification of a trade item that is a single product

Application description

The manufacturer or supplier has the option of assigning a unique GTIN-8, GTIN-12, GTIN-13 or in the case of regulated healthcare trade items and trade items used in manufacturing and maintenance, repair & overhaul (MRO) processes, a GTIN-14 to a trade item that is a single product as shown in figure [2.1.7-1](#). Restricted Circulation Numbers (RCNs) SHALL NOT be used in this element string.

GS1 key

Required

The allowed key formats for this application are:

- GTIN-8
- GTIN-12
- GTIN-13
- For regulated healthcare trade items and trade items used in manufacturing and maintenance, repair & overhaul (MRO) processes: GTIN-14.

Rules

See the GTIN rules described in section [4](#).

Attributes

Required

For regulated healthcare consumer trade items the following levels of AIDC marking are specified.

Figure 2.1.7.1-1. Overview of required attributes

AIDC marking level for regulated healthcare trade items	Key	Batch/lot number - AI (10)	Expiration date - AI (17)	Serial number - AI (21)	Other
Minimum	GTIN-8, GTIN-12, GTIN-13, or GTIN-14	No	No	No	None
Enhanced	GTIN-8, GTIN-12, GTIN-13, or GTIN-14	Yes	Yes	No	None
Highest – Brand owner AIDC marking	GTIN-8, GTIN-12, GTIN-13, or GTIN-14	Yes	Yes	Yes	Potency AI (7004) for pharmaceutical, and for medical device kits with pharmaceutical (cases only for both situations)
Highest – Hospital AIDC marking of pharmaceutical	GTIN-8, GTIN-12, GTIN-13, or GTIN-14	No	AI (7003) for short-life products	Yes	None
Hospital AIDC marking of medical devices	No	No	No	No	None

To manage healthcare data requirements within EPC/RFID tags, see section [3.11](#) and the most recent version of the [EPC Tag Data Standard](#).

Optional

Not applicable

Rules

Not applicable

Data carrier specification

Carrier choices

- Symbols from the EAN/UPC symbology family (UPC-A, UPC-E, may be used to encode the GTIN-12, EAN-13 to encode the GTIN-13 and, if the size requirements are met, EAN-8 to encode the GTIN-8 of the trade item that is a single product).
- ITF-14 symbols may be used where printing conditions require the application of a less demanding symbology. ITF-14 symbols can encode the GTIN-12, or GTIN-13 of the item.
- A GS1-128 barcode or GS1 DataBar barcode with GS1 Application Identifier (01) may be used to encode a GTIN that identifies the trade item if the printing conditions allow. The choice of one of these symbologies is particularly relevant if there is a need to encode attribute information in addition to the identification number.

Some scanning systems may be able to handle 2D barcodes as well as linear barcodes. In these environments, GS1 DataMatrix and GS1 QR Code may be used in addition to linear symbols. For information on how to manage multiple barcodes see section [4.15](#).

For trade items used in manufacturing and maintenance, repair & overhaul (MRO) processes the following data carrier choices take precedence over the carrier choices above: GS1-128, GS1 DataMatrix, GS1 QR Code and EPC/RFID.

For healthcare, the following carrier selections take precedence over the carrier choices above and apply to all regulated healthcare retail consumer trade items.

Figure 2.1.7.1-2. Healthcare carrier choices

<p>Preferred option(s) (this is the long-term direction for AIDC marking)</p>	<p>First preference: GS1-128 symbology. After Jan 2010, GS1 DataBar is permitted for use on all trade items and therefore may be encountered in general distribution however use of GS1-128 is preferred as the scanners in the field today pervasively support it.</p> <p>Second preference: When one linear symbol cannot accommodate the field length of the data (exceeds 48 characters), two symbols should be used.</p> <p>Third option: Where the package or label size does not permit the use of the first two options, GS1 DataMatrix symbology are permitted but should be avoided wherever possible if the package could be scanned by a mounted conveyerised scanner.</p>
<p>Option in addition to the barcode</p>	<p>See the "data carrier specification carrier choices" recommendations on options in addition to the barcode at the end of section 2.1.5.</p>
<p>Other acceptable options (GS1 strongly supports existing options for symbol marking as a guiding principle and therefore supports all previous AIDC marking specifications)</p>	<p>See the "data carrier specification carrier choices" recommendations on other acceptable options found at the end of section 2.1.5.</p>

Symbol X-dimensions, minimum symbol height and minimum symbol quality

For multi-sector use except for retail or regulated healthcare trade items see section [5.12.3.2](#), *GS1 symbol specification table 2*.

For regulated healthcare non-retail consumer trade items see section [5.12.3.8](#), *GS1 symbol specification table 8*.

For manufacturing and MRO processes see [5.12.3.4](#), *GS1 symbol specification table 4*.

Symbol placement

All the symbol placement guidelines defined in section [6](#).

Unique application processing requirements

For a description of processing requirements, see section [7](#).

2.1.7.2 Trade item groupings of identical trade items

Application description

A trade item grouping that is a predefined grouping of identical trade items. The manufacturer or supplier has the option of either assigning a unique GTIN-13 or GTIN-12 to each trade item grouping or assigning a unique GTIN-14. These 14-digit GTINs incorporate the GTIN (less its check digit) of the trade item contained in each grouping. The check digit for each GTIN-14 is then recalculated.

The indicators have no meaning. The digits do not have to be used in sequential order, and some may not be used at all. The GTIN-14 structure for trade item groupings creates extra numbering capacity.

Figure 2.1.7.2-1. GTIN-14 data structures

Global Trade Item Number (GTIN)														
Indicator	GTIN of contained trade items (without check digit)												Check digit	
GTIN-8 based	N ₁	0	0	0	0	0	N ₇	N ₈	N ₉	N ₁₀	N ₁₁	N ₁₂	N ₁₃	N ₁₄
GTIN-12 based	N ₁	0	N ₃	N ₄	N ₅	N ₆	N ₇	N ₈	N ₉	N ₁₀	N ₁₁	N ₁₂	N ₁₃	N ₁₄
GTIN-13 based	N ₁	N ₂	N ₃	N ₄	N ₅	N ₆	N ₇	N ₈	N ₉	N ₁₀	N ₁₁	N ₁₂	N ₁₃	N ₁₄

The indicator is a digit with a value of 1 to 8. It is assigned as required by the company that constructs the identification number. It can provide up to eight separate GTIN-14s to identify trade item groupings.

The check digit is explained in section 7.9. Its verification, usually carried out automatically by the barcode reader, ensures that the number is correctly composed.

Figure 2.1.7.2-2. Different groupings of the same trade item

Indicator	GTIN of trade item contained in the grouping, less its check digit	New check digit	Description	Quantity
	061414112345	2	Trade item	Single
1	061414112345	9	Trade item grouping	A grouping
...
8	061414112345	8	Trade item grouping	Another grouping

Indicators 1 to 8 may be used to create new GTIN-14s. When these eight indicators have been used, further groupings must be identified with either a GTIN-13 or GTIN-12. Indicator digit 9 is reserved for variable measure trade items, see section 2.1.10.

For packaging configuration hierarchies that include a retail consumer trade item identified with a GTIN-13, GTIN-12, or GTIN-8, this GTIN must always be one of the relevant levels of packaging contained, usually the lowest level (see note below related to GTIN-14 assignment on the primary packaging). Restricted Circulation Numbers must not be used in this element string.

 **Note:** For regulated healthcare trade items on the primary packaging, the phrase “usually the lowest level” SHALL be interpreted as allowing for the use of GTIN-14 on packaging configurations below the retail consumer trade item level, if one exists. This interpretation may not be applied to other trade item categories such as Do It Yourself (DIY) or Foodservice.

Any product package which will encounter scanning or product listing for sale at point-of-sale SHALL be identified according to retail point-of-sale specifications.

When a GTIN change at the retail consumer trade item level is required, the GTIN change must be made at all configuration levels above the retail consumer trade item level. Where there is an association between primary packaging and retail consumer trade item levels and GTIN-14 assignment is used on the primary packaging, the GTIN-14 assigned to the primary packaging is based on the retail level GTIN. There are three scenarios to consider for the relationship of these GTIN assignments:

- If changes to the primary packaging drive the change of the GTIN assigned to the retail consumer trade item level, the GTIN of the primary packaging will change.
- If changes to retail consumer trade item level GTIN are not caused by a change in primary packaging, the GTIN at the primary package level may or may not change per the discretion of the brand owner.

- If additional retail level package(s) are introduced beyond the original retail package or replace the original retail package, the GTIN-14 on the primary packaging may remain tied to the original retail level GTIN.

GS1 key

Required

The allowed key formats for this application are:

- GTIN-12
- GTIN-13
- GTIN-14

 **Note:** Product groupings created prior to 2023 may be identified with a GTIN-8. Starting on 1 January 2023, GTIN-8 SHALL NOT be used for application.

Rules

All the GTIN rules described in section 4.

Attributes

Required

For regulated healthcare non-retail consumer trade items the following levels of AIDC marking are specified:

Figure 2.1.7.2-3. Required attributes

AIDC marking level for regulated healthcare trade items	Key	Batch/lot number - AI (10)	Expiration date - AI (17)	Serial number - AI (21)	Other
Minimum	GTIN-12, GTIN-13, or GTIN-14	No	No	No	None
Enhanced	GTIN-12, GTIN-13, or GTIN-14	Yes	Yes	No	None
Highest – Brand owner AIDC marking	GTIN-12, GTIN-13, or GTIN-14	Yes	Yes	Yes	Potency AI (7004) for pharmaceutical, and for medical device kits with pharmaceutical (cases only for both situations)
Highest – Hospital AIDC marking of pharmaceutical	GTIN-12, GTIN-13, or GTIN-14	No	AI (7003) for short-life products	Yes	None
Hospital AIDC marking of medical devices	No	No	No	No	None

To manage healthcare data requirements within EPC/RFID tags, see section 3.11 and the most recent version of the [EPC Tag Data Standard](#).

Optional

Not applicable

Rules

Not applicable

Data carrier specification

Carrier choices

- For multi-sector use symbols from the EAN/UPC symbology family (UPC-A, UPC-E and EAN-13) may be used to encode the GTIN-12 or GTIN-13 of the trade item grouping.
- ITF-14 symbols may be used on trade item groupings where printing conditions require the application of a less demanding symbology. ITF-14 symbols can encode the GTIN-12, GTIN-13, or GTIN-14 of the item.
- A GS1-128 barcode or GS1 DataBar barcode with GS1 Application Identifier (01) may be used to encode a GTIN-12, GTIN-13, or GTIN-14 that identifies the trade item if the printing conditions allow. The choice of one of these symbologies is particularly relevant if there is a need to encode attribute information in addition to the identification number.

Some scanning systems may be able to handle 2D barcodes as well as linear barcodes. In these environments, GS1 DataMatrix and GS1 QR Code may be used in addition to linear symbols. For information on how to manage multiple barcodes see section [4.15](#).

For trade items used in manufacturing and maintenance, repair & overhaul (MRO) processes the following data carrier choices take precedence over the carrier choices above: GS1-128, GS1 DataMatrix, GS1 QR Code and EPC/RFID.

For healthcare the carrier selections noted at the end of section [2.1.7.1](#) take precedence over the carrier choices above and apply to all regulated healthcare retail consumer trade items.

Symbol X-dimensions, minimum symbol height and minimum symbol quality

For multi-sector use other than regulated healthcare trade items see section [5.12.3.2](#), *GS1 symbol specification table 2*.

For regulated healthcare non-retail consumer trade items see section [5.12.3.8](#), *GS1 symbol specification table 8*.

For manufacturing and MRO processes see [5.12.3.4](#), *GS1 symbol specification table 4*.

Symbol placement

All the symbol placement guidelines defined in section [6](#).

Unique application processing requirements

For a description of processing requirements, see section [7](#).

2.1.7.3 Trade item groupings of mixed trade items

Application description

A trade item grouping that is a predefined grouping of two or more different trade items.

For example:

- Product C is a grouping of Product A (GTIN 'A') and Product B (GTIN 'B'), and is identified with either a GTIN-12 or GTIN-13, GTIN 'C.'
- GTIN 'C' could then be used to construct a GTIN-14 for a trade item grouping comprised of Product C.

As shown in figure [2.1.7.3-1](#), the GTIN-12s 614141234561 and 614141345670 identify the two trade items in the trade item assortment/bundle identified by the GTIN 614141456789.

Figure 2.1.7.3-1. Example of trade item grouping of mixed trade items

Indicator	GTIN of trade item less its check digit	Check digit	Description	Quantity
	061414123456 061414134567	1 0	Retail consumer trade item (Product A) Retail consumer trade item (Product B)	Single Single
	061414145678	9	Retail consumer trade item (Product C)	Trade item assortment/bundle
1	061414145678	6	Trade item grouping	A grouping of the trade item assortment/bundle
...
8	061414145678	5	Trade item grouping	Another grouping of the trade item assortment/bundle

The indicators 1 to 8 may be used to create new GTIN-14s. When these eight indicators have been used, further groupings must be identified with either a GTIN-13 or GTIN-12. Indicator digit 9 is reserved for variable measure trade items, see section [2.1.10](#).

GS1 key

Required

The allowed key formats for this application are:

- GTIN-12
- GTIN-13
- GTIN-14

Rules

All the GTIN rules described in section [4](#); in addition, the GTIN-14 is valid for trade item groupings only when the trade item contained is a trade item assortment/bundle of two or more different trade items.

Attributes

Not applicable

Data carrier specification

Carrier choices

- Symbols from the EAN/UPC symbology family (UPC-A, UPC-E and EAN-13) may be used to encode the GTIN-12 or GTIN-13 of the trade item grouping.
- ITF-14 symbols may be used on trade item groupings where printing conditions require the application of a less demanding symbology. ITF-14 symbols can encode the GTIN-12, GTIN-13, or GTIN-14 of the item.
- A GS1-128 barcode or GS1 DataBar barcode with GS1 Application Identifier (01) may be used to encode a GTIN-12, GTIN-13, or GTIN-14 that identifies the trade item if the printing conditions allow. The choice of one of these symbologies is particularly relevant if there is a need to encode attribute information in addition to the identification number.

Some scanning systems may be able to handle 2D barcodes as well as linear barcodes. In these environments, GS1 DataMatrix and GS1 QR Code may be used in addition to linear barcodes. For information on how to manage multiple barcodes see section [4.15](#).

For trade items used in manufacturing and maintenance, repair & overhaul (MRO) processes the following data carrier choices take precedence over the carrier choices above: GS1-128, GS1 DataMatrix, GS1 QR Code and EPC/RFID.

For healthcare, the carrier selections noted at the end of section [2.1.7.1](#) take precedence over the carrier choices above and apply to all regulated healthcare retail consumer trade items.

Symbol X-dimensions, minimum symbol height and minimum symbol quality

For multi-sector use other than regulated healthcare trade items see section [5.12.3.2](#), *GS1 symbol specification table 2*.

For regulated healthcare non-retail consumer trade items see section [5.12.3.8](#), *GS1 symbol specification table 8*.

For manufacturing and MRO processes see [5.12.3.4](#), *GS1 symbol specification table 4*.

Symbol placement

All the symbol placement guidelines defined in section [6](#).

Unique application processing requirements

For a description of processing requirements, see section [7](#).

2.1.8 Medical devices (non-retail trade items)

Application description

Within this application are the rules and recommendations for the direct part marking (DPM) of medical devices for the Automatic Identification and Data Capture (AIDC) management, including medical devices that are reprocessed (within the micro-logistics cycle of use, including cleaning and sterilisation).

Medical devices SHOULD be identified with GTIN and any appropriate GS1 Application Identifiers used for production control, as determined by the responsible entity for the device. For medical devices that are reprocessed, GTIN and serial number are recommended for manufacturers that use DPM to enable traceability throughout the product life cycle.

Also, for hospitals or instrument owners that mark medical devices that are reprocessed, GTIN and serial number are recommended for all hospital/instrument owner marking. Some existing in-house legacy systems already use GS1 asset identifiers (GIAI or GRAI, see section [2.3](#)), which are compliant with GS1 standards.



Note: Only one GS1 key (GTIN or GIAI/GRAI) SHOULD be marked on a single instrument.

GS1 key

Required

The allowed key formats for this application are:

- GTIN-12
- GTIN-13
- GTIN-14
- GRAI
- GIAI

Rules

- All the GTIN rules described in section [4](#).
- All the GIAI and GRAI application rules described in section [4.4](#).
- If the AIDC marking on the medical device may be seen and scanned when placed in the protective packaging after sterilisation, the protective packaging will not have to be AIDC marked.

Attributes

Required

Not applicable

Optional

When using GTIN-12, GTIN-13, or GTIN-14 to identify a medical device that is reprocessed, a serial number is recommended to complete the identification. To manage GS1 healthcare data requirements within EPC/RFID tags, see section [3.11](#) and the [EPC Tag Data Standard](#).

Rules

Not applicable

Data carrier specification

Carrier choices

Medical devices (non-retail trade items), when direct marked, SHALL be marked with GS1 DataMatrix symbology. See section [2.6.14](#) for more details.

Symbol X-dimensions, minimum symbol height and minimum symbol quality

See section [5.12.3.7](#), *GS1 symbol specification table 7*.

Symbol placement

All the symbol placement guidelines defined in section [6](#).

Unique application processing requirements

For a description of processing requirements, see section [7](#).

2.1.9 Fixed measure trade items packed in several individual pieces not scanned at retail POS

Application description

The trade item includes two or more pieces that are marked for non-POS scanning purposes such as inventory management, theft prevention, or quality control. The identifier of each individual piece consists of the Global Trade Item Number (GTIN) of the trade item, the piece number and the total count of pieces in the trade item. The GTIN on all pieces of the trade item must be the same.

GS1 key

Required

The Global Trade Item Number (GTIN) is the GS1 identification key used to identify trade items. For the identification of pieces of a trade item, additional information is provided with a piece number and the total number of pieces. See section [3.2](#), Identification of an individual trade item piece: AI (8006).

Rules

- AI (8006) SHALL NOT be used for the identification of a single trade item piece.
- AI (8006) SHALL NOT be used for the identification of pieces that are themselves trade items, such as spare parts.
- The value of AI (8006) of all pieces of a trade item SHALL contain the same GTIN, the same total number of pieces and a different piece number.
- When the pieces of a trade item are packaged together, the value of the GTIN marked on the package SHALL be the same as the GTIN marked on the contained physical units.

- For trade items that pass the point-of-sale, all of the pieces of the trade item SHALL be packaged or presented together and identified with the GTIN.

Also see the GTIN rules described in section [4](#).

Attributes

Required

Not applicable.

Optional

See section [3](#) for an overview of all GS1 Application Identifiers and their intended usage.

Rules

See section [4.13 Data relationships](#). If used, optional AIs on all pieces of a trade item and on the trade item itself SHALL be identical.

Data carrier specification

Carrier choices

For multi-sector use except for regulated healthcare retail consumer trade items, data carriers used to represent each individual piece using the GS1 Application Identifier AI (8006) are GS1-128, GS1 DataMatrix, GS1 QR Code and EPC/RFID.

For healthcare, the following carrier selections take precedence over the carrier choices above and apply to all regulated healthcare retail consumer trade items.

Figure 2.1.9-1. Healthcare carrier choices

Preferred option	GS1-128 symbology
Option in addition to the barcode	See the recommendations on "Options in addition to the barcode" at the end of section 2.1.5

Symbol X-dimensions, minimum symbol height and minimum symbol quality

See section [5.12.3.2](#), *GS1 symbol specification table 2* and [5.12.3.4](#), *GS1 symbol specification table 4*.

Symbol placement

All the symbol placement guidelines defined in section [6](#).

Unique application processing requirements

For a description of processing requirements, see section [7](#).

2.1.10 Variable measure trade items scanned in general distribution

Application description

Trade items may be of variable measure either because the production process does not guarantee consistency in weight, size, or length (e.g., carcasses of meat, whole cheeses) or because the items are created to meet a special order that states a quantity (e.g., textiles ordered by the metre, glass ordered by the square metre).

Only trade items that are sold, ordered, or produced in quantities that can vary continuously, are covered by the rules outlined in this section. Trade items that are sold in discrete and predefined bands (e.g., as a nominal weight) are treated as fixed measure trade items.

A trade item must be considered a variable measure trade item if its measure is variable at any point in the supply chain. For example, a supplier may sell and invoice chickens in cases of 15 kilograms each; therefore, the quantity of contained chickens will vary. The customer, a retailer in

this example, may need to know the exact number of chickens contained in each case in order to organise the distribution to his stores. In this example, the supplier should source mark the trade item by using a variable measure Global Trade Item Number (GTIN) and the variable count element string.

Variable measure trade items scanned in general distribution are identified with a GTIN-14 beginning with '9'. The digit 9 in the indicator position indicates that the item identified is a variable measure trade item that is not scanned at POS.

 **Note:** See section [2.6.8](#) for the GTIN-14 beginning with a '9' in combination with AI (242) Made-to-Order variation number and its use in the manufacturing and maintenance, repair & overhaul (MRO) environment.

Unlike GTIN-14s beginning with indicator 1 to 8 which are used to identify fixed measure trade items (see section [2.1.7.2 Trade item groupings of identical trade items](#)), this GTIN-14 is not derived from the GTIN (without check digit) of the contained trade items. The GTIN-14 must be processed in its entirety and not broken down into its constituent elements.

Figure 2.1.10-1. Format of the element string

Global Trade Item Number (GTIN)					
Indicator	GS1 Company Prefix			Item reference	Check digit
(GTIN-14)	9	N ₂ N ₃ N ₄ N ₅ N ₆ N ₇ N ₈ N ₉ N ₁₀ N ₁₁ N ₁₂ N ₁₃			N ₁₄

The check digit is explained in section [7.9](#). Its verification, usually carried out automatically by the barcode reader, ensures that the number is correctly composed.

Any trade item of a given composition where the quantity/measure information cannot be pre-determined for any reason is a variable measure trade item. The most frequent types are shown in the figure below.

Figure 2.1.10-2. Main types of variable measure trade items

Type	Item description
A	Items traded in bulk, neither portioned nor pre-packed for retail sale, ordered in any quantity, and that are delivered as variable measure trade items (e.g., fish, fruit, vegetables, cables, carpets, timber, fabrics) The identification number denotes the item as a trade entity containing any quantity of the given product and, if applicable, the form of packaging. Weight or dimensions complete the identification of the individual unit.
B	Trade items ordered and delivered by piece (wrapped or unwrapped) and invoiced by weight or measure because weight or measure varies due to the nature of the product or due to the manufacturing process (e.g., whole cheese, sides of bacon, beef carcasses, fish, sausages, ham, chicken, cauliflower, motion picture films) The identification number denotes the item as a particular predefined entity and, if applicable, denotes the form of packaging. Price or weight or dimensions complete the identification of the individual item.
C	Portioned trade items, pre-packed for sale by weight to the consumer, not fixed in quantity. (e.g., meat, cheese, vegetables, fruit, fillets of fish, sliced poultry, cold cuts) The identification number denotes the item type according to business practice and the form in which it is packed. Price weight or dimension completes the identification of the individual unit.
D	Trade items with selectable dimensions where GS1 system standard numbering does not make sense to cover the multiplicity of all variations (e.g., wooden planks, carpeting) The identification number denotes the predefined basic trade item. The applicable dimension(s) completes the identification of the individual unit.
E	Composition of a fixed number of trade items that are Type B or Type C (e.g., a trade item containing 10 chickens (Type B).) The identification number denotes the trade item grouping as an entity and, if applicable, its form of packaging. The total weight of all items contained completes the identification of the particular trade item.
F	Trade items made to customer specifications, restricted in use to the Maintenance, Repairs and Operations industrial supply sector, and sold business-to-business. The identification number denotes a base custom item. The specific variation is identified by the Made-to-Order variation number. (See in section 3.2 for the list of all GS1 Application Identifiers).

GS1 key

Required

GTIN-14 with indicator digit 9.

Rules

The GTIN-14 with the indicator 9 is used to identify a variable measure trade item. The presence of the variable measure information is mandatory for the complete identification of a variable measure trade item. The digit 9 in the first position is an integral part of the GTIN.

The GTIN-14 data structure beginning with indicator 9 is not used on an item intended to cross the retail point-of-sale. Numbering of variable measure fresh food trade items intended to cross retail point-of-sale is defined in section [2.1.12](#).

Attributes

Required

The GTIN-14 identifies a variable measure trade item with respect to its fixed attributes or characteristics. To complete the identification of a variable measure trade item, the presence of an element string representing a trade measure is mandatory.

Optional

Applicable trade measures depend on the nature of the product. They may be a quantity, a weight, or any dimension.

- An element string with GS1 Application Identifier (30) is used if the variable measure of the trade item is the number of items contained. In order to generate a short barcode, always enter an even number of digits in the data field "variable count of items" by inserting a leading zero if necessary. Concatenation of this element string with the GTIN of the item enhances the accuracy of the application. See section [3.6.1](#), *Variable count of items: AI (30)*.
- An element string with GS1 Application Identifiers (31nn), (32nn), (35nn) and (36nn) is used if the variable measure of the respective trade item is weight, dimension, area, or volume. Only one element string of a given unit of measure may be applied on a particular item. Several element strings containing trade measures are possible on a particular item if the item is available in either unit of measure and if the applicable unit of measure is not distinguished for ordering and billing. This might apply if weight must be expressed in kilograms and pounds, see section [3.2](#), *Trade measures: AIs (31nn), (32nn), (35nn), (36nn)*.
- An element string with GS1 Application Identifier (8001) contains the predefined variable fields of a roll product and it may be used for those variable roll products where the trade measures AI (31nn), (32nn), (35nn), (36nn) are not sufficient. The GTIN-14 can denote a basic roll product.

Rules

An element string with GS1 Application Identifier (30) SHOULD never be used to indicate the quantity contained in a fixed measure trade item. However, if it appears on a fixed measure trade item, it SHOULD NOT invalidate the trade item identification.

An element string with GS1 Application Identifier (8001) must never be used together with other element strings representing trade measures.

Data carrier specification

Carrier choices

Variable measure trade items not crossing a point-of-sale SHOULD be marked with an ITF-14 barcode, GS1-128 barcode or GS1 DataBar barcode.

Some scanning systems may be able to handle 2D barcodes as well as linear barcodes. In these environments, GS1 DataMatrix and GS1 QR Code may be used in addition to linear symbols. For information on how to manage multiple barcodes see section [4.15](#).

Symbol X-dimensions, minimum symbol height and minimum symbol quality

See section [5.12.3.2](#), GS1 symbol specification table 2.

Symbol placement

All the symbol placement guidelines defined in section [6](#).

Unique application processing requirements

For a description of processing requirements, see section [7](#).

Examples of variable measure trade item numbering and symbols

In the examples in the subsections that follow, the following factors apply:

- In order to be illustrative, all examples show the same presentation (e.g., price list, order, delivery, invoice and recording in a data file).
- GS1-128 barcodes are used.
- The examples are given to demonstrate the correct use of a given GS1 Application Identifier when used. When AI (02) is not used, information about the shipment must be received using Electronic Data Interchange (EDI) or other means prior to its physical receipt.

Example 1: Traded by piece

The following example shows the order and delivery of an item traded by piece and invoiced by weight.

- The supplier’s catalogue contains one entry: one salami weighing ~ 500 grams.
- The order for 100 units is delivered in three boxes. Each box is marked with an SSCC (Serial Shipping Container Code) and, optionally, with information on the content of the box, expressed as follows:
 - AI (02) indicates the variable measure Global Trade Item Number (GTIN) of the units contained within the box.
 - AI (3101) indicates the total weight of the items contained within the box.
 - AI (37) indicates the count of items contained within the box.
- The three boxes may be stored on a pallet that may itself be marked with an SSCC and, optionally, with information on the contents of the pallet, expressed as follows:
 - AI (02) indicates the variable measure GTIN of the units contained within the pallet.
 - AI (3101) indicates the total weight of the items contained within the pallet.
 - AI (37) indicates the count of items contained within the pallet.
- The invoice refers to the GTIN and quantity delivered and shows the total weight and the price per kilogram. The GTIN and quantity of the invoice match the GTIN and quantity of the order.

Figure 2.1.10-3. Example 1: Traded by piece, invoiced by weight

Process	Description	Element strings used/symbol marking of the items
Supplier’s catalogue	1 Salami ~ 500 g	GTIN 97612345000018
Order	100 salamis	100 x 97612345000018
Delivery	three logistic units Unit 1 = 33 salamis, 16.7 kg Unit 2 = 33 salamis, 16.9 kg Unit 3 = 34 salamis, 17.1 kg	Unit 1: 00 376123450000010008 02 97612345000018 3101 000167 37 33 Unit 2: 00 376123450000010015 02 97612345000018 3101 000169 37 33 Unit 3: 00 376123450000010022 02 97612345000018 3101 000171 37 34
	If delivery is made on a pallet	Pallet: 00 376123450000010039 02 97612345000018 3101 000507 37 0100

Process	Description	Element strings used/symbol marking of the items
Invoice	GTIN of items and the total weight (50.7 kg) + the price per kg	100 x 97612345000018; 50.7 kg x price per kg

Data file logistic units	Identification of logistic unit (SSCC)	GTIN of contained trade items	Total trade weight of content (grams)	Number of units contained
Either pallet	376123450000010039	97612345000018	50700	100
or individual units	376123450000010008	97612345000018	16700	33
	376123450000010015	97612345000018	16900	33
	376123450000010022	97612345000018	17100	34

Data file trade items	GTIN of trade item	Total trade weight (grams)	Number of trade items
One record per identification number	97612345000018	50700	100

An element string with an GS1 Application Identifier (410) represents the Global Location Number (GLN) of the recipient of a logistic unit. The GLN refers to the address where a particular transport unit identified with an SSCC is to be delivered. This element string is used in single leg transport operations. A logistic unit may include a barcode carrying the GLN of the unit's intended destination. When scanning this element string, the data transmitted may be used to retrieve the related address and/or to sort the item by destination.

Example 2: Traded by trade item grouping

The following example shows the order and delivery of an item traded by trade item grouping and invoiced by weight.

- The supplier's catalogue contains one entry: one case of 20 steaks weighing ~ 200 grams each.
- The order is for three cases. Each case delivered is marked with the Global Trade Item Number (GTIN) of a single case followed by the actual weight of the items contained.
- The three cases may be stored on a pallet that may itself be marked with an SSCC (Serial Shipping Container Code) and, optionally, with information on the contents of the pallet, expressed as follows:
 - AI (02) indicates the variable measure GTIN of the units contained within the pallet.
 - AI (3102) indicates the total weight of the items contained within the pallet.
 - AI (37) indicates the count of cases contained within the pallet.
- The invoice refers to the GTIN and quantity delivered and shows the total weight and the price per kilogram. The GTIN and quantity of the invoice match the GTIN and quantity of the order.

Figure 2.1.10-4. Example 2: Traded by trade item grouping, invoiced by weight

Process	Description	Element strings used/symbol marking of the items
Supplier's catalogue	1 case of 20 steaks ~ 200 g vacuum packed	GTIN 97612345000117
Order	Three cases	3 x 97612345000117
Delivery	Three trade items Unit 1: weight = 4.150 kg Unit 2: weight = 4.070 kg Unit 3: weight = 3.980 kg	Unit 1: 01 97612345000117 3102 000415 Unit 2: 01 97612345000117 3102 000407 Unit 3: 01 97612345000117 3102 000398
	If delivery is made on a pallet	Pallet: 00 376123450000010091 02 97612345000117 3102 001220 37 03
Invoice	GTIN of items and the total weight (12.20 kg) + the price per kg	3 x 97612345000117; 12.2 kg x price per kg

Data file logistic units	Identification of logistic unit (SSCC)	GTIN of contained trade items	Total trade weight of content (grams)	Number of units contained
Pallet	37612345000010091	97612345000117	12200	3

Data file trade items	GTIN of trade item	Total trade weight	Number of trade items
One Record	97612345000117	12200	3

Example 3: Traded in bulk

The following example shows an order and delivery of an item traded in bulk.

- The supplier's catalogue contains one entry: cabbage unwrapped sold in bulk by kilogram.
- The order is for 100 kilograms. It is delivered in two cases. Each case is marked with the Global Trade Item Number (GTIN) of the cabbage followed by the actual weight of the items contained.
- The two cases may be stored on a pallet that may itself be marked with an SSCC (Serial Shipping Container Code).
- The invoice refers to the GTIN as ordered and shows the total weight and the price per kilogram. The delivered weight may be verified as being close to the ordered quantity.

Figure 2.1.10-5. Example 3: Traded in bulk

Process	Description	Element strings used/symbol marking of the items
Supplier's catalogue	Cabbage unwrapped sold in bulk by kilogram	GTIN 97612345000049
Order	100 kg of cabbage	100 kg x 97612345000049
Delivery	Two trade items Unit 1: weight = 42.7 kg Unit 2: weight = 57.6 kg	Unit 1: 01 97612345000049 3101 000427 Unit 2: 01 97612345000049 3101 000576
	If delivery is made on a pallet	Pallet: 00 376123450000010107
Invoice	GTIN of item and the total weight (100.3 kg) + the price per kg	97612345000049 100.3 kg x price per kg

Data file logistic units	Identification of logistic unit (SSCC)	GTIN of contained trade items	Total trade weight of content (grams)	Number of units contained
Pallet	376123450000010107	97612345000049 97612345000049	42700 57600	1 1

Data file trade items	GTIN of trade item	Total trade weight (grams)	Number of trade items
One record per trade item	97612345000049 97612345000049	42700 57600	1 1

Example 4: Traded by trade item grouping

The following example shows an order of variable measure trade items by case that are invoiced by the number of pieces delivered.

- The supplier's catalogue contains one entry: one case of ~ 10 cabbages sold by piece.
- The order is for two cases. Each case delivered is marked with the Global Trade Item Number (GTIN) of a single case followed by the actual count of the items contained.

- The two cases may be stored on a pallet that may itself be marked with an SSCC (Serial Shipping Container Code) and, optionally, with information on the contents of the pallet, expressed as follows:
 - AI (02) indicates the variable measure GTIN of the units contained within the pallet.
 - AI (30) indicates the total count of the items contained within the pallet.
 - AI (37) indicates the count of cases contained within the pallet.
- The invoice refers to the GTIN as ordered and delivered and the total count of items.

Figure 2.1.10-6. Example 4: Traded by trade item grouping, invoiced by piece

Process	Description	Element strings used/symbol marking of the items
Supplier's catalogue	Case containing ~10 cabbages sold by pieces	GTIN 97612345000285
Order	Two cases	2 x 97612345000285
Delivery	Unit 1: 11 pieces Unit 2: 12 pieces	Unit 1: 01 97612345000285 30 11 Unit 2: 01 97612345000285 30 12
	If delivery is made on a pallet	Pallet: 00 376123450000010138 02 97612345000285 30 23 37 02
Invoice	GTIN of the trade item and the total quantity	2 x 97612345000285 23 pieces x price per piece

Data file logistic units	Identification of logistic unit (SSCC)	GTIN of contained trade items	Total number of pieces contained in the trade item	Number of units contained
Pallet	376123450000010138	97612345000285	23	2

Data file trade items	GTIN of trade item	Total number of pieces	Number of trade items
One Record	97612345000285	23	2

Example 5: Traded in bulk

The following example shows a product that can be purchased from a supplier or sold to a customer by any length in metres.

- The supplier's catalogue contains one entry: cable T49 sold in metres.
- The order is for one length of cable of 150 metres. The delivered package is marked with the Global Trade Item Number (GTIN) of the cable followed by the actual length of cable contained.
- The invoice refers to the GTIN as ordered and delivered and the total length.

Figure 2.1.10-7. Example 5: Traded in bulk

Process	Description	Element strings used/symbol marking of the items
Supplier's catalogue	Cable T49 sold in any length in MTR	GTIN 97612345000063
Order	One trade item of 150 MTR	97612345000063 x 150 MTR
Delivery	One trade item, 150 MTR	01 97612345000063 3110 000150
Invoice	GTIN of the trade item and the total quantity	1 x 97612345000063 150 x price per MTR

Data file trade items	GTIN of trade item	Total trade length (metres)
One record	97612345000063	150

2.1.1.11 Fixed measure trade items – restricted distribution applications

This section describes applications where the item identification is defined only in a closed environment. However, within their closed environment these items may be processed along with trade items identified with Global Trade Item Numbers (GTINs) defined for open trade.

These identification numbers are known as Restricted Circulation Numbers (RCNs) and may be 8, 12 or 13 digits in length. Eight-digit numbers are known as RCN-8s, 12-digit numbers as RCN-12s and 13-digit numbers as RCN-13s.

The regulations established by GS1 Member Organisations for their country or assigned area should be observed for the allocation of these Restricted Circulation Numbers:

- When assigned to company internal use, the structure and management of the numbers represented in the element strings of this section are the responsibility of the user. Number changes and reuse of expired numbers must be managed by the user based on their requirements.
- When centrally administrated within a geographic area, the GS1 Member Organisation determines the structure and manages number allocation based on user requirements.

Restricted circulation fixed measure trade items are defined only in a closed environment. Therefore, the distribution of trade items marked in this way is restricted to a given geographic region or for use within a company. These items are either marked in the store by the retailer or are marked at the source by the supplier.

GS1 Member Organisations may assign one or several of the GS1 Prefixes 02, 20 through 29 for the identification of fixed measure trade items with RCN-13s or RCN-12s for use within a given geographic region or for use within a company.

Restricted circulation numbers (RCNs) SHALL only be encoded in EAN-8, EAN-13, UPC-A, or UPC-E symbols. RCNs SHALL NOT be encoded using any Application Identifiers.

2.1.11.1 Company internal numbering – RCN-8 Prefix 0 or 2

Application description

This element string uses an RCN-8 Prefix of 0 or 2. It provides two million identification numbers, which can be assigned for internal use in a company. When the RCN-8 Prefix is 0, the element string is sometimes called a velocity code because it is quicker to key enter.

This element string is for internal use in a company. The numbers are assigned by individual companies and do not provide unique identification if they leave the company premises.

Figure 2.1.11.1-1. Data structure RCN-8 Prefix 0 or 2

RCN-8 Prefix	Item reference						Check digit
N ₁	N ₂	N ₃	N ₄	N ₅	N ₆	N ₇	N ₈

The RCN-8 Prefixes 0 or 2 are system identifiers that show that the item identification number is under the sole control of the assigning company and that it is for internal item distribution.

The item reference is allocated by the company that uses the element string. The positions N₂ to N₇ may contain any digit.

The check digit is explained in section 7.9. Its verification, carried out automatically by the barcode reader, ensures that the number is correctly composed.

The data transmitted from the barcode reader means that one fixed measure trade item with a GTIN-8 has been captured.

- ✔ **Note:** In addition to trade item identification, this element string may be used for any purpose that is supported by the company's equipment supplier.
- ✔ **Note:** In some environments where numbers may have to be key entered, the EAN-8 barcode carrying RCN-8s (and the RCN-8 Prefix 0) may be confused with the numbers carried

by a UPC-E barcode. If such a risk exists, it is preferable to use the RCN-8 Prefix 2 capacity for internal use.

GS1 key

Not applicable

Attributes

Not applicable

Data carrier specification

Carrier choices

- EAN-8 (carrying a RCN-8)

Symbol X-dimensions, minimum symbol height and minimum symbol quality

See section [5.12.3.1](#), *GS1 symbol specification table 1*.

Symbol placement

Not applicable

Unique application processing requirements

Not applicable

2.1.11.2 Company internal numbering – RCN-13 GS1 Prefix 04 (RCN-12 U.P.C. Prefix 4)

Application description

Any company in the world may use this element string for company internal trade item numbering. If the RCN-12 U.P.C. Prefix 4 is being applied, the user company may structure the trade item number.

Although this element string is mainly used for the identification of trade items, it may be used for any purpose as long as it is kept within a restricted environment. This element string is for a company’s internal use. Because any company may use this element string, it does not provide unique identification of a trade item if it leaves the company’s premises.

Figure 2.1.11.2-1. Data structure RCN-13 Prefix 04

GS1 Prefix	Item reference										Check digit
0 4	N ₃	N ₄	N ₅	N ₆	N ₇	N ₈	N ₉	N ₁₀	N ₁₁	N ₁₂	N ₁₃

The GS1 Prefix 04 is a system identifier showing that the identification number is under the sole control of the assigning company and that it is for internal trade item distribution.

The item reference is assigned by the company that uses the element string. Positions N₃ to N₁₂ may contain any digit.

The check digit is explained in section [7.9](#). Its verification, carried out automatically by the barcode reader, ensures that the number is correctly composed.

The data transmitted from the barcode reader means that one fixed measure trade item with a RCN-13 or RCN-12 has been captured.

GS1 key

Not applicable

Attributes

Not applicable

Data carrier specification

Carrier choices

- EAN-13 (carrying RCN-13)
- UPC-A (carrying RCN-12)

Symbol X-dimensions, minimum symbol height and minimum symbol quality

See section [5.12.3.1](#), *GS1 symbol specification table 1*.

Symbol placement

Not applicable

Unique application processing requirements

Not applicable

2.1.11.3 Company internal numbering – RCN-12 U.P.C. Prefix 0 (LAC and RZSC)

Application description

The U.P.C. Company Prefix 0 includes a reserved capacity for company internal numbering, using Local Assigned Codes (LACs) or Retailer Zero-Suppression Codes (RZSCs), which are carried by a UPC-E barcode. U.P.C. Company Prefixes 000000 and 001000 to 007999 are used in this feature. For details, see the figure below.

Although this element string is mainly used for the identification of trade items in restricted distribution, it may be used for any purpose as long as it is kept within a restricted environment.

This element string is for a company's internal use. Because any company may use this element string, it does not provide unique identification of a trade item if it leaves the company's premises.

Figure 2.1.11.3-1. UPC-E barcode option for the identification of GTINs for company internal distribution

GTIN-12 Identification Number of Trade Item											Check Digit	Represented in UPC-E Symbol Positions							
N ₁	N ₂	N ₃	N ₄	N ₅	N ₆	N ₇	N ₈	N ₉	N ₁₀	N ₁₁	N ₁₂	1	2	3	4	5	6		
(0) 0	0	1	0	0	0	0	0	0	0	5	2	0	1	0	0	0	'5'		
(0) 0	<u>0</u>	<u>7</u>	<u>9</u>	<u>9</u>	<u>9</u>	0	0	0	0	<u>9</u>	7	<u>0</u>	<u>7</u>	<u>9</u>	<u>9</u>	<u>9</u>	'9'		
LAC version = 35000 UPC-E Bar Code Applications																			
(0) 0	0	1	0	0	0	0	0	1	0	0	4	0	1	1	0	0	'0'		
(0) 0	<u>0</u>	<u>5</u>	<u>0</u>	0	0	0	0	<u>9</u>	<u>9</u>	<u>9</u>	2	<u>0</u>	<u>5</u>	<u>9</u>	<u>9</u>	<u>9</u>	'0'		
RZSC version = 4500 UPC-E Bar Code Applications																			
(0) 0	0	0	0	0	0	0	0	0	0	0	0	0	0	0	0	0	'0'		
(0) 0	<u>0</u>	<u>0</u>	<u>0</u>	0	0	0	0	<u>9</u>	<u>9</u>	<u>9</u>	7	<u>0</u>	<u>0</u>	<u>9</u>	<u>9</u>	<u>9</u>	'0'		
Velocity version = 1000 UPC-E Bar Code Applications																			

In figure 2.1.11.3-1, each number position must only contain the digits shown in the upper and lower lines of each section and those in-between. On decoding, the extension to full length is determined by the value of the number in single quotes in the column represented in UPC-E barcode positions.

The check digit applies to the entire length of the RCN-12. In the UPC-E barcode, it is implicitly represented by the parity combination of the six symbol characters that are actually encoded. The check digit and how to calculate it is explained in section 7.9. Its verification, carried out automatically by the barcode reader, ensures that the number is correctly composed

GS1 key

Not applicable

Attributes

Not applicable

Data carrier specification

Carrier choices

UPC-E (carrying RCN-12 with GS1 Prefix 00 and digits 01 to 07 in the next two positions).

Symbol X-dimensions, minimum symbol height and minimum symbol quality

See section 5.12.3.1, GS1 symbol specification table 1.

Symbol placement

Not applicable

Unique application processing requirements

It is possible to create a false UPC-E barcode if the encodation rules are not properly observed. Whether the digits represented in a UPC-E barcode can be expanded correctly to an RCN-12 may be verified by the tests shown in section [7.10](#).

2.1.11.4 GS1 Prefixes 02, 20 to 29 - Restricted distribution

Application description

The GS1 Prefixes 02, 20 to 29 are reserved for identification purposes within a restricted geographic area. Each GS1 Member Organisation is entitled to assign the prefixes to be used for these element strings in its country or assigned area:

- for the identification of variable measure trade items or fixed measure trade items.
- for internal numbering of variable measure trade items or fixed measure trade items by a particular company.

 **Note:** Suppliers manufacturing their own label products for several different customers should use unique GS1 system numbering to distinguish their customers. If this is not done, the supplier will not be able to use Electronic Data Interchange (EDI) or electronic catalogues.

Although this element string is mainly used for the identification of trade items, it may be used for any purpose as long as it is kept within a restricted environment.

This element string is for use within a GS1 Member Organisation's geographic region. The GS1 Member Organisation may assign a company a GS1 Prefix for use externally throughout a region or may assign the prefix for use internally within a region. The numbers are never unique if they leave the region and, if assigned for a company's internal use, are not unique if they leave the company or region.

Figure 2.1.11.4-1. Format of the element string

GS1 Prefix	Item reference	Check digit
0 2	N ₃ N ₄ N ₅ N ₆ N ₇ N ₈ N ₉ N ₁₀ N ₁₁ N ₁₂	N ₁₃
2 N ₂	N ₃ N ₄ N ₅ N ₆ N ₇ N ₈ N ₉ N ₁₀ N ₁₁ N ₁₂	N ₁₃

The GS1 Prefix must be in the series 02, 20 to 29. A particular prefix may be assigned either for use on fixed measure trade items for restricted distribution or for variable measure trade items (see section [2.1.12](#)).

The item reference is assigned by the company that uses the element string. Positions N₃ to N₁₂ may contain any digit.

The check digit is explained in section [7.9](#). Its verification, carried out automatically by the barcode reader, ensures that the number is correctly composed.

The data transmitted from the barcode reader means that one fixed measure trade item with a RCN-13 or RCN-12 has been captured.

GS1 key

Not applicable

Attributes

Not applicable

Data carrier specification

Carrier choices

- EAN-13

Symbol X-dimensions, minimum symbol height and minimum symbol quality

See section [5.12.3.1](#), *GS1 symbol specification table 1*.

Symbol placement

Not applicable

Unique application processing requirements

Not applicable

2.1.12 Variable measure trade items scanned at retail POS

This section describes applications for variable measure trade items that are scanned at retail point-of-sale. Two main applications exist:

- Variable measure fresh food trade items using a GTIN and additional attributes encoded with GS1 DataBar Expanded or GS1 DataBar Expanded Stacked. See section [2.1.12.1](#). During a transition period, 2D barcodes may be applied in addition to the linear barcode. For a summary of all conformance requirements for this AIDC application standard, 2D barcodes, cross-application rules and related technical specifications, see section [8.4](#). GTINs SHALL be encoded with AI (01).
- Variable measure trade items using a Restricted Circulation Number (RCN) SHALL be encoded in EAN/UPC barcodes. See section [2.1.12.2](#).

For information on how to manage multiple barcodes see section [4.15](#).

2.1.12.1 Variable measure fresh food trade items scanned at retail POS using GTIN**Application description**

Like a fixed measure trade item, a variable measure trade item is an entity with predefined characteristics, such as the nature of the product or its contents. Unlike a fixed measure trade item, a variable measure trade item has one measure that varies continuously while other characteristics remain the same. In the case of fresh food trade items variable measure may be weight, length, number of items contained, or volume. There are different ways to handle the process for variable measure fresh food. For example:

- Consumer puts loose produce items into a bag and a barcoded label is produced and attached by the consumer.
- Staff attaches a barcode label, produced in store to pre-packed loose produce trade item.
- At the POS, loose produce is weighed and the price is calculated.

It is at the discretion of the retailer how the price is calculated and which process is chosen.

Variable measure fresh food

Variable measure loose produce trade items are trade items which may be identified with a GTIN and additional data. The retailer decides how to handle Variable measure fresh food trade items sold at POS. Generally, the individual item(s) (i.e. loose produce) are put into a bag by the customer or by staff and are scanned (if a label is generated in store) or weighed at POS to generate the price. The attributes of variable measure trade items are barcoded when the trade item is weighed or measured in store. If the variable measure trade item is weighed at POS when presented to the cashier the price is generated in the register and directly added to the other products to complete the transaction.

Variable measure pre-packed fresh food trade items

These are Variable measure fresh foods trade items, either loose produce or cut from a bulk item, that are pre-packaged with differing weight or other variable measure using GTIN and attributes. The label put on the trade item encoding GTIN plus variable measure information and/or price is determined by the retailer.

GS1 key

Required

The allowed key formats for this application are:

- GTIN-12
- GTIN-13

Rules

All GTIN rules described in section [4.2](#).

Attributes

Required

See section [3.6.1](#) and [3.6.2](#), a variable count or a trade measure (AIs (30), (31nn), (32nn), (35nn), (36nn))

Optional

- See section [3.2](#) - *GS1 Application Identifiers in numerical order* for a complete list of all GS1 Application Identifiers. For instance, the amount payable and/or best before date may also be included.
- For more details related to GS1 Application Identifiers for fresh foods, refer to the [GS1 AIDC Fresh Foods Sold at Point-of-Sale Implementation Guideline](#).

Rules

Not applicable.

Data carrier specification

Carrier choices

- GS1 DataBar Expanded
- GS1 DataBar Expanded Stacked



Note: During a transition period, 2D barcodes may be applied in addition to the linear barcode. For a summary of all conformance requirements for this AIDC application standard, 2D barcodes, cross-application rules and related technical specifications, see section [8.4](#).



Note: GS1 data carriers using AIs encode a 14-digit numeric string. When encoding GTIN-13 or GTIN-12 after AI (01), zero-fill with one or two zeroes to the left of the GTIN.

Symbol X-dimensions, minimum symbol height and minimum symbol quality

See section [5.12.3.1](#), *GS1 symbol specification table 1*.

Symbol placement

None

Unique application processing requirements

None

2.1.12.2 Variable measure trade items scanned at retail POS using RCN

Application description

Restricted circulation variable measure trade items are those sold in random quantity against a fixed price per unit quantity and intended to cross a point-of-sale (e.g., apples sold at a fixed price per kilogram). These items are either marked in the store by the retailer or are marked at the source by the supplier. National solutions are available for this purpose.

GS1 Member Organisations SHOULD assign one or several of the GS1 Prefixes 02, 20 through 29 for the identification of variable measure trade items in their territory. GS1 Member Organisations SHOULD make part of this capacity available to user companies for company internal applications.

The data fields available after the relevant GS1 Prefix (defined by the GS1 Member Organisation for their territory) can be structured in a variety of ways to represent the product type, net weight, calculated price, or number of units. Equipment is commercially available for automatically weighing items, calculating an item price from the unit price and printing the information as a barcode label. The scanning equipment and applications can then be programmed to use the prefix as an instruction to decode the ensuing data fields according to the particular structure adopted.

The first row in the figure below shows the structure specified by GS1 US for North America. The same structure is used by many other GS1 Member Organisations. The next two rows do not show predetermined structures. Examples of recommended structures are given in the figure 2.1.12.2-2 below. GS1 Member Organisations choose appropriate structures for use within their geographic area.

Figure 2.1.12.2-1. Format of the element string

GS1 Prefix	Item reference	Price verifier digit	Item price	Check digit
0 2	N ₃ N ₄ N ₅ N ₆ N ₇	N ₈	N ₉ N ₁₀ N ₁₁ N ₁₂	N ₁₃
0 2	N ₃ N ₄ N ₅ N ₆ N ₇ N ₈ N ₉	N ₁₀ N ₁₁ N ₁₂		N ₁₃
2 N ₂	N ₃ N ₄ N ₅ N ₆ N ₇ N ₈ N ₉	N ₁₀ N ₁₁ N ₁₂		N ₁₃

The item reference is usually assigned by the company that scans the element string at its point-of-sale. However, some countries may specify their own standard numbering systems for variable measure products administered by their GS1 Member Organisation or by a trade association.

The price verifier digit is the result of a special calculation, and its verification ensures correct reading of the price. For details, see section 7.9. Security of reading this element string without a price verifier digit depends on the element string’s check digit (see section 7.9).

The item price is the price of the trade item in the relevant currency with an implied decimal point defined by the trading partners or the relevant GS1 Member Organisation. A different format is required for each position of the implied decimal point. Multiple formats require an unambiguous way to differentiate each format, and separate GS1 Prefixes may be assigned to accomplish this.

The check digit is explained in section 7.9. Its verification, carried out automatically by the barcode reader, ensures that the data corresponds with the verification rules.

Figure 2.1.12.2-2. Examples of alternative data structures

Item reference	Price verifier digit	Item price
Item reference		Item price
Item reference	Measure verifier digit	Item measure
Item reference		Item measure

When the price (or weight) of an item is encoded using this element string, a price verifier digit or a measure verifier digit SHOULD be used. The measure verifier digit is calculated from the digits in the item measure field in the same way that the price verifier digit is calculated from the item price digits (see section 7).

The item measure is a measurement of the trade item with a defined unit of measure and an implied decimal point position. The unit of measure and decimal point position are defined within the relevant geographic area for each GS1 Prefix and/or format code. The item measure may be weight only if local weights and measures regulations permit.

The data transmitted from the barcode reader means that data about a variable measure trade item has been captured. The barcode reader normally performs the price verifier digit and the measure verifier digit calculation. Failing this, the calculation must take place in the application software.

Although each GS1 Member Organisation and/or user is free to develop a solution for numbering variable measure trade items, the GS1 system provides recommended structures that provide a degree of equipment standardisation. These formats may include an item reference, the retail price of the item and a price check digit. The recommended structures are shown in the figure below.

Figure 2.1.12.2-3. Recommended data structures

GS1 Prefix	Recommended data structures (exact structure determined by GS1 Member Organisation)	Check digit
0 2	I I I I I V P P P P	C
or	I I I I V P P P P P	C
2 0 - 2 9	I I I I I I P P P P	C
	I I I I I P P P P P	C

The GS1 Prefix is administered by each GS1 Member Organisation and denotes the format and meaning of a particular element string, where:

- **I..I** = Item reference.
- **V** = Price check digit calculated according to the algorithm specified in section [7.9](#).
- **P..P** = Price in local currency.
- **C** = Check digit calculated according to the standard algorithm in section [7.9](#).

 **Note:** The price field may contain zero, one, or two implied decimal places depending on the monetary unit used. The decimal point, which is not included in the barcode, must nevertheless be taken into account by the marking equipment when printing the human readable interpretation on the label.

GS1 Member Organisations may choose to implement a national solution for variable measure trade items branded by the supplier for retail. Any national branded variable measure solution requires GS1 Member Organisations to manage the allocation of the item number at a national level.

GS1 key

Not applicable

Attributes

Not applicable

Data carrier specification

Carrier choices

- UPC-A (carrying RCN-12)
- EAN-13 (carrying RCN-13)

Symbol X-dimensions, minimum symbol height and minimum symbol quality

See section [5.12.3.1](#), *GS1 symbol specification table 1*.

Symbol placement

Not applicable

Unique application processing requirements

Not applicable

2.1.13 Trade item extended packaging applications

The information obtained from a consumer trade item's packaging can be extended when consumers using mobile devices scan barcodes on the package, which leads them to more information or an application. This standard provides a standardised packaging solution, which will lead to brand owner authorised information.

Independent of whether a trade item is retail or non-retail, fixed or variable measure, if it is sold to the end consumer and utilises GTIN-based identification, then it is within the scope of this application.

This application standard has three approaches to enable extended packaging applications,

- GS1 Digital Link URI syntax ([2.1.13.1](#))
 - For new extended packaging applications, the GS1 Digital Link URI syntax is encoded in QR Code or Data Matrix.
- GS1 element string (AI-based) syntax ([2.1.13.2](#))
 - Prior to the GS1 Digital Link standard, GS1 approved two approaches to reach extended packaging applications that were available within the GS1 system of standards.
 - An indirect mode of look-up via GTIN

This relies upon mobile device applications (apps) to use the GTIN encoded in EAN/UPC, GS1 DataBar, GS1 DataMatrix, or GS1 QR Code. This approach remains valid, but its implementation is limited by the lack of support for attributes of GTIN and the need to conduct a look-up to find a Web-based resource (indirect mode).
 - A direct mode of look-up utilising GS1 element string (AI-based) syntax approach that relies upon AIs (01) and (8200) to produce a product URL

This uses the GTIN and an additional GS1 Application Identifier (8200) to produce a product URL. This approach can be used to reach brand owner authorised information or applications via direct mode, but implementation has been limited at the global level by the need for an app to construct the URL from the decoded data.

For a summary of all conformance requirements for this AIDC application standard, cross-application rules and related technical specifications, see section [8.5](#).

2.1.13.1 GS1 Digital Link URI syntax for extended packaging applications for trade items

The GS1 Digital Link standard (DL) provides a packaging solution that can lead to brand owner authorised information. It uses a Web URI syntax to encode GS1 data, (e.g., GTIN and attribute data) in QR Code or Data Matrix barcodes. GTIN SHALL be expressed as 14 digits, with leading zeroes serving as filler digits, as defined by the *GS1 Digital Link Standard: URI Syntax*, and shown in the examples below. The *GS1 Digital Link Standard: URI syntax* is a ratified GS1 technical standard, see <https://www.gs1.org/standards/gs1-digital-link>.

Although the GS1 Digital Link standard offers a compressed form of the GS1 Digital Link URI syntax, this application SHALL use the uncompressed form. For example, GTIN 09506000134369 can be encoded in a QR Code or Data Matrix to form a GS1 DL URI <https://example.com/01/09506000134369>.

Figure 2.1.13.1-1. Examples of QR Code and Data Matrix with GS1 DL URI Syntax

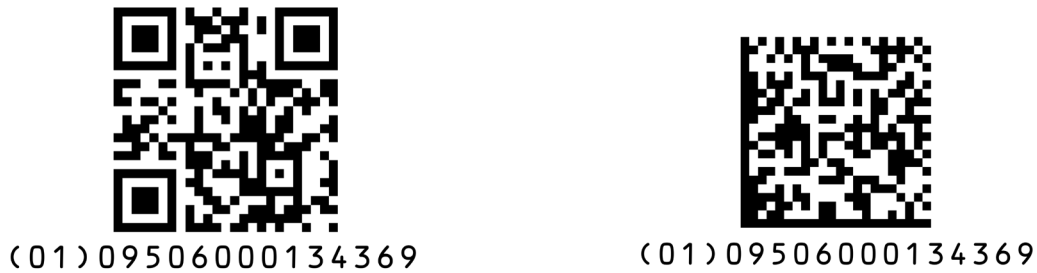

- ✔ **Note:** The example.com domain name (reserved in [RFC 2606](#)) is used in the example as a place holder for any domain name.

As the GS1 DL encodes GS1 data in barcodes using a Web URI syntax, it differs from previous 'direct' and 'indirect' approaches described in section [2.1.13.2](#) because it explicitly encodes a resolvable Web URI. The GS1 Digital Link URI syntax also differs from the previous approaches in that it supports all GTIN attributes and provides standardised concatenation of multiple element strings.

GS1 key

Required

The allowed key formats for this application are:

- GTIN-8
- GTIN-12
- GTIN-13

Rules

See the *GTIN rules* described in section [4](#).

Attributes

Required

Not Applicable

Optional

See section [3](#) for the overview of all GS1 Application Identifiers that may be used with trade items

Data carrier specification

Carrier choices

- QR Code
- Data Matrix

Symbol X-dimensions, minimum symbol height and minimum symbol quality

See [5.12.3.1](#), Symbol specification table 1 addendum 2 for GS1 Digital Link.

Symbol placement

For additional barcodes that carry GS1 DL URIs (i.e. QR Code and Data Matrix), see section [4.15.1](#).

Unique application processing requirements

For a description of processing steps, see section [7](#) and the [GS1 Digital Link standard](#) .

2.1.13.2 GS1 element string syntax for extended packaging applications for trade items

The GS1 element string syntax provides an extended packaging solution that can lead to brand owner authorised information. The GTIN is the primary GS1 key used to access GS1 B2C data standards and services and all GS1 application standards for consumer trade items require GTIN, therefore this standard makes normative reference to the sections in the *GS1 General Specifications* related to consumer trade items in the figure below.

In addition to using GTIN and indirect mode to reach trusted data, the URL AI (8200) with GTIN can be used to reach brand owner authorised information or applications via direct mode. GTIN and AI (8200) are encoded as separate data elements in the barcode but once decoded they are processed in a standard fashion by concatenating the following three strings: the contents of AI (8200), followed by a slash (/) character, followed by the GTIN expressed as 14 numeric digits. For example, where a trade item's GTIN, when expressed as 14 digits is 01234567890128 and the URL for direct mode access to information is <http://example.com/01234567890128>.

When encoded in the symbol, the sequence for encoding is (01) 01234567890128 (8200) <http://example.com>, but when processed the URL, a slash and the GTIN are combined to arrive at <http://example.com/01234567890128>.

The example provided is not intended to constrain the brand owner to the use of http URL schema, the .com top-level domain, or the specific structure of URL illustrated. Any URL may be used, and in processing the slash character and 14-digit GTIN are appended.

These values are also expressed in non-HRI text on the label (see section 4.14). If GTIN attributes beyond AI (8200) are encoded together with GTIN and PRODUCT URL they are processed and expressed in text on the label as <http://brandownerassignedURL.com/gtin/serialnumber> where serial number equals up to 20 alphanumeric digits.

Figure 2.1.13.2-1. Overview of related normative sections

Section	Title	General retail POS	Regulated healthcare: retail POS	Regulated healthcare: non-retail / POC
2.1.3	Fixed measure trade items scanned at retail POS	Yes		
2.1.3.6	Fixed measure fresh food trade items scanned at retail POS	Yes		
2.1.4	Fixed measure trade items scanned in general distribution and at retail POS	Yes		
2.1.5	Healthcare primary packaging (non-retail trade items)*			Yes
2.1.6	Healthcare secondary packaging (regulated healthcare retail consumer trade items)*		Yes	
2.1.7.1	Fixed measure trade items scanned in general distribution - identification of a trade item that is a single product*			Yes
2.1.12.1	Variable measure fresh food trade items scanned at retail point-of-sale using GTIN	Yes		

Section	Title	General retail POS	Regulated healthcare: retail POS	Regulated healthcare: non-retail / POC
<p>*Important: For healthcare applications AI (8200) will be deprecated on 31 December 2026, healthcare applications SHALL NOT utilise AI (8200) after this date</p>				

GS1 key

Required

The allowed key formats for this application are:

- GTIN-8
- GTIN-12
- GTIN-13
- For regulated healthcare non-retail applications also: GTIN-14

Rules

All rules in the sections that appear in figure [2.1.13.2-1](#) apply as described in each section.

Attributes

Required

For the purpose of direct mode, AI (8200) must be used in combination with GTIN when brand owners provide extended packaging information or applications.

Optional

For the purpose of indirect mode, all attributes in the sections which appear in the figure in section [2.1.13](#) apply as described in each section.

Rules

All rules in the sections that appear in figure [2.1.13.2-1](#) apply as described in each section.

Data carrier specification

Carrier choices

For the purpose of supporting indirect mode, all carrier choices in the sections which appear in the figure [2.1.13.2-1](#) apply as described in each section.

For the purpose of direct mode, in addition to the symbol required for indirect mode, when AI (8200) is used, GS1 DataMatrix and GS1 QR Code are the only approved data carriers. See also section [4.15](#).

Symbol X-dimensions, minimum symbol height and minimum symbol quality

To determine the appropriate specifications for printing and quality control, see the GS1 symbol specification table(s) referred to in each application standard shown in figure [2.1.13.2-1](#).

Symbol placement

None defined.

Unique application processing requirements

For a description of processing requirements, see section [7](#).

2.1.14 European Regulation 2018/574, traceability of tobacco products

This application standard provides a normative GS1 response to a specific regulatory requirement. It covers identification and marking of various entities per the *Commission Implementing Regulation (EU) 2018/574 on technical standards for the establishment and operation of a traceability system for tobacco products*, https://ec.europa.eu/health/tobacco/tracking_tracing_system_en. If regulatory authorities outside the EU adopt the EU approach, this application standard is intended to support their efforts and enable global interoperability.

The regulation specifies where ISO/IEC 15459 compliant GS1 identification keys can be used to identify:

4. Unit packs (retail trade item consumer units) for traceability purposes (retail point of sale specifications are defined within separate application standard [2.1.3](#))
5. Aggregates defined as “any packaging containing more than one unit packet of tobacco products” (trade item groupings), including:
 - a. Trade item grouping (e.g., higher level aggregations of unit packs such as cartons and cases) defined within separate application standards [2.1.4](#) or [2.1.7](#).
 - b. Logistic units (e.g., aggregation of unit packs as transport units) defined within separate application standard [2.2.1](#).
6. Economic operators defined by EU 2018/574 as “any natural or legal person who is involved in the trade of tobacco products, including for export, from the manufacturer to the last economic operator before the first retail outlet” and where “Economic operators and operators of first retail outlets shall apply for an economic operator identifier code from the ID issuer competent for each Member State in which they operate at least one facility.”
7. Facilities defined by EU 2018/574 as “any location, building or vending machine where tobacco products are manufactured, stored or placed on the market”
8. Machines defined as “the equipment used for the manufacture of tobacco products which is integral to the manufacturing process”

The regulation also specifies ISO/IEC, AIM and GS1 compliant barcodes for unit packs and aggregations as well as ISO/IEC 15415 and 15416 print quality minimums.

The regulation introduces an extension of ISO/IEC 15459 Issuing Agency Codes (IACs) to identify the Member State appointed ID Issuer called the Unique Identification Code (UIC). As EU 2018/574 extends the IAC function to identify ID Issuers, GS1 will assign ID Issuer Unique Identification Codes (UICs) from its Issuing Agency Code allocation. GS1 identification keys will be used as they are currently used and their ‘values’ will remain unchanged for supply chain functions and systems as GS1 identification keys are already pervasively deployed and, in the case of Unit Pack Unique Identifier (upUI), already used for EU-CEG 2015/2186’s Tobacco Product Number *registrations*. Additionally, a GS1 identification key shall not become an EU 2018/574 compliant identifier for economic operators, facilities, or machines until GS1 validates the key and an appointed ID Issuer authorises the GS1 identification key for use. As multiple ID Issuers may authorise the same GS1 identification key value, the UIC must be concatenated before the GS1 identification key to provide context for national authorisation of a GS1 identification key to create an Economic Operator ID (EOID), Facility ID (FID), or Machine ID (MID).

In order to address the EU 2018/574 requirements while not modifying previously assigned values within GS1 identification keys, the following specifications are established.

GS1 Issuing Agency Code-based, ID Issuer Unique Identification Code (with Extensions)

1. One ID Issuer Unique Identification Code (UIC) SHALL be licensed to each ID Issuer that adopts a GS1 standards-based approach to EU 2018/574 identification. NOTE: UICs assigned by GS1 SHALL begin with a numeric character in the first position of the ID Issuer Unique Identification Code. Issuing Agency Codes 0 through 9 are allocated exclusively to GS1 and shall not be used in the first position of an ISO/IEC compliant identifier unless allocated by GS1.
2. A GS1 ID Issuer UIC SHALL be added before a GS1 identification key to form EU 2018/574 compliant economic operator identifiers (EOIDs), facility identifiers (FIDs) and machine identifiers (MIDs), while permitting use of GS1 identification keys without UIC to support open, supply chain business processes.

3. The same AI SHALL be used for the UIC independent of its use with EOID, FID, or MID and the ID Issuer UIC value SHALL be the same whether used within upUI, EOID, FID, or MID and independent of the country where the ID Issuer (individual legal entity) operates.
4. As GS1 identification keys are international and because ID Issuer UIC is the same for all countries where it operates, a GS1 UIC Extension 1 SHALL directly follow the UIC. The GS1 UIC Extension 1 permits an ID Issuer to operate in all 28 EU Member States. An additional capacity of up to 54 countries is held in reserve for the potential adoption of solutions outside the EU of the EU 2018/574 approach. Of this 54, GS1 is holding 20 to allow capacity for geopolitical change.
5. GS1 supports GS1 and non-GS1 TPX algorithms. To communicate which algorithm is being used, GS1 UIC Extension 2 provide 41 alphanumeric characters each to GS1-based and non-GS1 based algorithm users.

unit pack Unique Identifier (upUI)

1. The UIC SHALL appear in the first position of the Third Party Controlled, Serialised Extension of GTIN (TPX) and SHALL be licensed, along with GS1 UIC Extensions 1 and 2, to each ID Issuer for the duration of their appointment by an official National Authority. GS1 UIC Extension 1 indicates the Member State where the ID Issuer is operating and UIC Extension 2 indicates whether a GS1 or non-GS1 algorithm is used. These two provisions are required to ensure identifiers are unique across National Authorities and between entities who are appointed as ID Issuer by each National Authority over time.
2. TPX SHALL appear before GTIN to accommodate the UIC. This will require an additional Group Separator character after the TPX (as the TPX is a non-predefined element string). Inclusive of the Group Separator character and AI, the maximum TPX element string length SHOULD NOT exceed 21 barcode symbol characters to accommodate high-speed production (e.g., two symbol characters for the GS1 Application Identifier and the first digit of the TPX, plus 19 alphanumeric for the remaining TPX data element).

Aggregated unit packs (aUIs) offered as trade items (referred to as trade item groupings by GS1)

1. Serialised GTINs (SGTINs), as determined by brand owners, SHALL be used.
2. As SGTINs are assigned by economic operators, they SHALL NOT be preceded by the UIC to form the aUI for trade item use in the EU 2018/574 system.

Aggregated unit packs at transport unit level (referred to as logistic units by GS1)

1. Serial Shipping Container Codes (SSCCs), as assigned by economic operators, SHALL be used.
2. As SSCCs are assigned by economic operators, they SHALL NOT be preceded by the UIC to form the aUI for trade item use in the EU 2018/574 system.

Economic Operator ID (EOID)

1. GLNs, as assigned by economic operators, SHALL be submitted within Economic Operator ID Request messages for ID Issuer authorization.
2. When authorised by the ID Issuer, the GLN SHALL be preceded by the UIC, GS1 UIC Extension 1 and Importer index to form the EOID for use in the EU 2018/574 system.
3. GLNs without the UIC SHALL continue to be used, as is, within GS1 Data Sharing Standards to support existing supply chain requirements.

Facility (FID)

1. GLNs, as assigned by economic operators, SHALL be submitted within Facility ID Request messages for ID Issuer authorization.
2. When authorised by the ID Issuer, the GLN SHALL be preceded by the UIC, GS1 UIC Extension 1 and Importer index to form the FID for use in the EU 2018/574 system.
3. GLNs without the UIC SHALL continue to be used, as is, within GS1 Data Sharing Standards to support existing supply chain requirements.

Machine ID (MID)

1. GIAIs, as assigned by economic operators, SHALL be submitted within Machine ID Request messages for ID Issuer authorization.
2. When authorised by the ID Issuer, the GIAI SHALL be preceded by the UIC, GS1 UIC Extension 1 and Importer index to form the MID for use in the EU 2018/574 system.
3. GIAIs without the UIC SHALL continue to be used, as is, within GS1 Data Sharing Standards to support existing supply chain requirements.

2.1.14.1 Trade Items at EU 2018/574 Unit Pack Level

GS1 identification key

Definition

To identify trade items at unit pack level:

1. The GTIN-8 is the 8-digit GS1 identification key composed of a GS1-8 Prefix, item reference and check digit used to identify trade items.
2. The GTIN-12 is the 12-digit GS1 identification key composed of a U.P.C. Company Prefix, item reference and check digit used to identify trade items.
3. The GTIN-13 is the 13-digit GS1 identification key composed of a GS1 Company Prefix, item reference and check digit used to identify trade items.

 **Note:** EU 2015/2186 specifies GTIN, UPC-12 and EAN-13 as a product number. UPC-12 is a legacy term replaced by GTIN-12. EAN-13 is a legacy term replaced by GTIN-13. GTIN-8 is another legitimate structure of GTIN for retail-consumer trade items. As GTIN-14 is not permitted on retail consumer trade items as the value for GTIN in the EAN/UPC and upUI barcodes MUST be the same, GTIN-14 is not permitted for the EU 2018/574 unit pack Unique Identifier.

Rules

GTIN is used exclusively within GS1 traceability solutions (e.g., GS1 EPCIS-based solutions.)

When an additional barcode (beyond the retail point-of-sale barcode) is required to support inline printing, the GTIN in both barcodes SHALL be the same value per section [4.13](#).

All the GTIN rules described in section [4](#).

For general human readable interpretation rules see section [4.14](#). The regulation requires human readable text to reflect the characters which must be key entered in order to make a repository look-up. To reduce confusion of customs and other regulatory users GS1 Application Identifiers SHALL NOT be printed where the human readable text used for repository look-up is clearly indicated on the package.

Attributes

Required

For unit pack level, Third Party Controlled Serialised Extension of GTIN (TPX)

Rules

This solution supports interoperability by specifying Global Trade Item Number (GTIN) as the primary identification key for 'product code' within the unit level Unique Identifier (EU 2018/574 term for the serialised product code). After GTIN, all other requirements are met with the Third Party Controlled Serialised Extension of GTIN (TPX) as an attribute of GTIN.

The Unit Pack Unit Identifier (upUI) shall be up to 50 characters per EU 2018/574, but should be the shortest length possible that accommodates explicit encoding of the GTIN element string. This

because GTIN provides backwards compatibility for the retail supply chain and the shortest length possible enables reliable high-speed printing.

Note Where the TPX is intended for high-speed, inline printing, the TPX data element should not exceed 20 alphanumeric characters. When encoded in a barcode, the 14-digit GTIN and Application Identifier (01) require eight symbol characters because numeric characters are encoded in barcodes at twice the efficiency of alpha or special characters. This means the total encoded characters for GTIN and TPX, when allocated for high-speed production lines, should not exceed 29 symbol characters.

The TPX SHALL always be encoded before GTIN to comply with EU 2018/574 UIC specifications.

AI (21) Serial Number SHALL NOT be used when AI (235) is used.

Optional

For EU 2018/574 unit packs, a timestamp is optional within the data carrier.

If timestamp is encoded as a separate element string, AI (8008), date and time of production, to hourly precision, SHALL be used. If encoded, the AI (8008) element string to hourly precision (12 numeric characters, 8008YYMMDDhh) will require six barcode symbol characters in addition to mandatory GTIN and required TPX element strings (which should not exceed 29 symbol characters).

If timestamp is encoded, it may be omitted from the HRI adjacent to the data carrier unless the ID Issuer specifies that the timestamp is required to retrieve repository information related to the upUI.

If timestamp is not encoded, it MUST be shown in HRI below the data carrier.

In HRI, the TPX SHALL appear in the first position.

In the non-HRI text, the timestamp SHALL appear in the last position and be clearly separated from GTIN where AI (8008) is not encoded. Only GTIN, TPX and optionally timestamp, SHALL be permitted per EU 2018/574 in the data carrier for the unit pack Unique Identifier.

Data carrier specification

Carrier choices, per EU 2018/574, for trade items at EU 2018/574 unit pack level

- GS1 DotCode



Note: GS1 DotCode use is restricted to this application standard and only the unit level.

- GS1 DataMatrix
- GS1 QR Code

Symbol X-dimensions, minimum symbol height and minimum symbol quality

See section [5.12.3.12](#), *GS1 system symbol specification table 12*.

Symbol placement

For this application, a symbol is required on unit packs in addition to the symbol used at retail POS, therefore [4.15](#), Rule 4 Non-Adjacent Placement should be followed.

Unique application processing requirements

For a description of processing requirements, see section [7](#).

2.1.14.2 Aggregated unit packs (aUIs) offered as trade items (referred to as trade item groupings by GS1)

GS1 identification key

Definition

Within a GS1 based implementation, aggregated level UIs shall be generated and issued directly by the economic operator. A GTIN allocated by brand owners and a serial number determined by brand

owners supports aggregate Unique Identifier (aUI) per EU 2018/574. To identify trade item groupings (unit pack aggregation - cartons, cases), see sections [2.1.4](#) or [2.1.7](#).

Rules

GTIN is used exclusively within GS1 traceability solutions (e.g., GS1 EPCIS-based solutions.)

All the GTIN rules described in section [4](#).

Attributes

Required

AI (21) Serial Number.

Rules

Not applicable

Optional

For all the GS1 Application Identifiers (AI) that can be used with a GTIN, see section [3](#).

Data carrier specification

Carrier choices, per EU 2018/574, for trade item grouping (unit pack aggregation into cartons, cases)

- GS1 DataMatrix
- GS1 QR Code
- GS1-128



Note: GS1-128 should be used, at a minimum, where the trade item grouping will encounter supply chain systems beyond those covered by this regulation. Where a trade item grouping will also be sold at retail point-of-sale (e.g., carton of cigarettes), a barcode specified for POS (see section [2.1.4](#).) SHALL be used in addition to those introduced by this regulation. If the barcode specified for the regulation becomes specified for retail point-of-sale, one barcode will suffice.

Symbol X-dimensions, minimum symbol height and minimum symbol quality

See section [5.12.3.12](#), *GS1 system symbol specification table 12*.

Symbol placement

All the symbol placement guidelines defined in section [6](#).

Unique application processing requirements

For a description of processing requirements, see section [7](#).

2.1.14.3 Aggregated unit packs at transport unit level (referred to as logistic units by GS1)

GS1 identification key

Definition

Within a GS1 based implementation, aggregated level UIs shall be generated and issued directly by the economic operator. SSCC, as allocated by economic operators, supports aggregate Unique Identifier (aUI) for transport units per EU 2018/574. To identify logistics units (unit pack aggregation transport units), per ISO/IEC 15459-1, see section [2.2.1](#).

Rules

See section [4.3](#)

Attributes**Required**

Not applicable

Rules

See section [4.3](#).

Optional

Not applicable

Data carrier specification**Carrier choices, per EU 2018/574, for logistic units (unit pack aggregation into transport units)**

- GS1 DataMatrix
- GS1 QR Code
- GS1-128



Note: Use of GS1-128 should be used, at a minimum, where the logistics will encounter supply chain systems beyond those covered by this regulation.

Symbol X-dimensions, minimum symbol height and minimum symbol quality

See section [5.12.3.12](#), *GS1 system symbol specification table 12*.

Symbol placement

All the symbol placement guidelines defined in section [6](#).

Unique application processing requirements

For a description of processing requirements, see section [7](#).

2.1.14.4 Machine Identification per at EU 2018/574 (referred to as individual asset by GS1)**GS1 identification key****Definition**

Within a GS1 based implementation, machines (individual assets) are identified in two steps. First, the economic operator provides a Global Individual Asset Identifier (GIAI), which is validated by GS1. In parallel, ID Issuer validates all other attributes of the Machine ID (MID) Request. Once validated, the ID Issuer UIC, GS1 UIC Extension 1 and Importer index are concatenated before the GIAI to form the MID. To identify individual assets, see sections [2.3.2](#) and [3.9.4](#) Global Individual Asset Identifier (GIAI): AI (8004).

Rules

See section [4.4](#).

Attributes**Required**

GS1 UIC with Extension 1 and Importer index AI (7040)

Optional

Not applicable

Data carrier specification

Not applicable for EU 2018/574.

Unique application processing requirements

For a description of processing requirements, see section [7](#).

2.1.14.5 Facility per at EU 2018/574 (referred to as physical location by GS1)**GS1 identification key****Definition**

Within a GS1 based implementation, facilities (physical locations) are identified in two steps. First, the economic operator provides a Global Location Number (GLN), which is validated by GS1. In parallel, the ID Issuer validates all other attributes of the Facility ID (FID) Request. Once validated, the ID Issuer UIC, GS1 UIC Extension 1 and Importer index are concatenated before the GLN to form the FID. To identify physical locations, see sections [2.4](#) and [3.7.9](#) Identification of a physical location - Global Location Number: AI (414).

Rules

All the GLN rules described in section [4.5](#).

Attributes**Required**

GS1 UIC with Extension 1 and Importer index AI (7040)

Rules

Per section [4.5](#)

Optional

Not applicable

Data carrier specification

Not applicable for EU 2018/574.

Unique application processing requirements

For a description of processing requirements, see section [7](#).

2.1.14.6 Economic operator per at EU 2018/574 (referred to as party by GS1)**GS1 identification key****Definition**

Within a GS1 based implementation, economic operators (parties) are identified in two steps. First, the economic operator provides a Global Location Number (GLN), which is validated by GS1. In

parallel, the ID Issuer validates all other attributes of the Economic Operator ID (EOID) Request. Once validated, the ID Issuer UIC, GS1 UIC Extension 1 and Importer index are concatenated before the GLN to form the EOID. To identify parties, see sections [2.4.5](#) and [3.7.12](#) Identification of a party - Global Location Number: AI (417).

Rules

All the GLN rules described in section [4.5](#).

Attributes**Required**

GS1 UIC with Extension 1 and Importer index AI (7040)

Rules

Per section [4.5](#).

Optional

Not applicable

Data carrier specification

Not applicable for EU 2018/574.

Unique application processing requirements

For a description of processing requirements, see section [7](#).

2.1.15 Identification of non-new trade items

Application description**Background**

All new trade items that are identified using the GS1 system will have been issued a GTIN prior to their first use or consumer purchase. The GTIN is the same for all instances of the same trade item. In addition to the GTIN, some trade items have additional, more granular identification information, such as consumer product variant (CPV), a batch/lot number and/or a serial number. Each of these more granular GS1 identification key components are always associated to the GTIN. In most cases, the GTIN is present on the packaging of a new trade item and encoded in a barcode (see section [4.13.2](#)).

Some new trade items have barcodes or RFID tags that include one or more pieces of more granular identification information in addition to the GTIN. For example, an RFID tag that is encoded with GS1 identification will include the GTIN and the serial number of a new trade item. Another example is 2D barcodes, such as a QR Code with a GS1 Digital Link URI, which can also include more granular GS1 identification key components in addition to the GTIN.

Trade item declarations and offer declarations**Trade item declarations**

Any trade item has trade item declarations (see section [4.2.2.2](#)) that is the set of all information that is on the label and in the original packaging. Trade item declarations are declared by the original GTIN allocator (the party that assigned the GTIN to the trade item before the first use or consumer purchase).

Offer declarations

Any trade item that is being listed for sale has a set of offer declarations, which is the set of all information declared (or agreed to) by the seller about the trade item (inclusive of price, availability, terms of sale, claims, condition of the item, shipping information, returns information, etc).

Non-new trade items

After the first use or consumer purchase, a trade item is considered non-new, noting that non-new trade items may not include trade items that have been returned for a refund. Non-new trade items include a wide range of products with varying levels of precision of existing identification, as explained above.

When deciding how to identify a non-new trade item, consideration SHOULD be given to several factors, including:

- Availability/knowledge of existing identification of the non-new trade item (e.g., the original GTIN and original serial number of the trade item that was assigned by the original GTIN allocator)
- Needs of downstream business processes (how do the non-new trade items need to be stocked, ordered, sold, fulfilled, etc.)
- Ability to scan, process and manage identification information at any level of precision beyond GTIN as it is expected that all systems can currently manage GTIN-level identification

Rules for identification of non-new trade items

Individual industries may have specific applications standards for managing identification of refurbished trade items, in which case those standards take precedence. For identification of refurbished components and parts for the rail industry, see the [Identification of Components and Parts in the Rail Industry – Application Standard](#). For all other cases, the following rules apply:

1. If there is no need to identify new and non-new instances of the same trade item separately, and no need to identify each non-new instance of an item with a GTIN and serial number, then identification with the originally assigned GTIN is sufficient.

If the brand owner assigned original GTIN of a trade item is not immediately known, effort SHALL be taken to discover and use this identifier to identify the non-new trade item. If the original GTIN cannot be recovered, a new GTIN SHALL be allocated according to the *GTIN Management Standard* or, for regulated healthcare products, the [GS1 Healthcare GTIN Allocation Rules Standard](#).

2. If there is a need to identify new and non-new instances of the same trade item separately, then the following possibilities for the identification of non-new trade items are available:
 - When identification of a non-new trade item can be managed at a serialised instance level by all downstream parties, the following rule applies:
 - If the original GTIN and the original serial number associated with the GTIN are known, and the serial number has not been decommissioned, then they SHALL be used to identify a non-new trade item (for information on end of life see [EPCIS Standard](#)). To take advantage of this instance level identification for business processes such as inventory management and price look up, systems will need to be able to use serial number and GTIN in order to access price, condition and other elements of the offer.
 - When identification of a non-new trade item cannot be managed at a serialised instance level by some or all downstream parties:
 - When a party adapts, refurbishes or modifies trade items in a way that results in a new set of trade item declarations (see [4.2.2.2](#)), a new GTIN SHALL be allocated. The party may be the original GTIN allocator or a downstream party. In this case, a linkage between the new GTIN and the original GTIN SHALL be maintained and provided to downstream trading partners if requested.
 - In certain instances, non-new trade items are made available for sale in restricted distribution applications, where identification with GTIN may not be necessary. Such closed supply chain environments may use trade item identification described in section [2.1.11](#). For such instances, consultation with your local GS1 Member Organisation is recommended.



Note: It is understood that some businesses use a proprietary combination of the original GTIN of a non-new trade item and other data (such as seller ID or another

internal number) that may exist in their system to generate unique identification of a particular offer of a non-new trade item. Such non-standard approaches are not globally-interoperable and their use must be mutually agreed. The rules in section [2.1.15](#) are designed to ensure globally-interoperable identification of non-new trade items

GS1 key

Required

GTIN-12

GTIN-13

GTIN-8

Rules

All GTIN rules described in section [4.2](#).

Attributes

Required

Not applicable

Optional

For all the GS1 Application Identifiers (AI) that can be used with a GTIN, see section [3](#).

Data carrier specification

Carrier choices

- UPC-A barcode (carrying GTIN-12 or RCN-12)
- EAN-13 barcode (carrying GTIN-13 or RCN-13)
- UPC-E barcode
- EAN-8 barcode
- GS1 DataBar Retail POS family (carrying GTIN-12 or GTIN-13 represented in a fixed length data string of 14 digits by adding leading zeroes)
- EPC/RFID

Symbol X-dimensions, minimum symbol height and minimum symbol quality

See section [5.12.3.1](#), *GS1 symbol specification table 1*.

Unique application processing requirements

For a description of processing requirements, see section [7](#).

Symbol placement

All symbol placement guidelines are defined in section [6.9](#).

2.2 Logistic units

A logistic unit is an item of any composition established for transport and/or storage that needs to be managed through the supply chain.

Tracking and tracing logistic units in the supply chain is a major application of the GS1 system. Scanning the standard identification number, marked on each logistic unit, allows the physical movement of units to be individually tracked and traced by providing a link between the physical

movement of items and the associated information flow. It also opens up the opportunity to implement a wide range of applications, such as cross docking, shipment routing and automated receiving.

Logistic units are identified with a GS1 identification number called the SSCC (Serial Shipping Container Code). The SSCC is the only GS1 key that SHALL be used as the identifier of a logistic unit. The SSCC ensures that logistic units are identified with a number that is unique worldwide.

If, in addition to being a logistic unit, the item is regarded as a trade item by the brand owner, it MAY additionally be identified with a GTIN. The combination of a GTIN and a serial number SHALL NOT replace the SSCC as the identifier of a logistic unit.

If, in addition to being a logistic unit, the item is part of a consignment and or a shipment, it MAY also be associated with the GINC and / or the GSIN.

Attribute information, such as a Global Identification Number for Consignment, AI (401), may be optionally encoded using internationally agreed data structures and a barcode symbology that allow unambiguous interpretation.

2.2.1 Individual logistic units

Application description

A logistic unit is an item of any composition established for transport and/or storage that needs to be managed through the supply chain. The identification and symbol marking of logistic units enables a large number of user applications. In particular, the SSCC (Serial Shipping Container Code) provides a link between the physical logistic unit and information pertaining to the logistic unit that is communicated between trading partners using Electronic Data Interchange (EDI).

The SSCC element string AI (00) is used for the identification of logistic units (see section 3). Each individual logistic unit is allocated a unique number, which remains the same for the life of the logistic unit. When assigning an SSCC, the rule is that an individual SSCC number must not be reallocated within one year of the shipment date from the SSCC assignor to a trading partner. However, prevailing regulatory or industry organisation specific requirements may extend this period.

In principle, the SSCC provides a unique reference number that can be used as the key to access information regarding the logistic unit in computer files. However, attributes relating to the logistic unit (e.g., ship to information, logistic weights) are also available as standardised element strings.

GS1 key

Required

- SSCC

The GS1 Application Identifier for the SSCC is AI (00), see section 3.2.

Rules

All SSCC rules described in section 4.3.

Attributes

Required

Not applicable

Optional

For all the GS1 Application Identifiers that may be used with an SSCC, see section 3.2.

- ✓ **Note:** Although the use of AI (02), Identification of trade items contained, and AI (37), Count of trade items or trade item pieces contained in a logistic unit, is common in some sectors to describe the content of a logistic unit, the healthcare sector prefers the use of the SSCC alone. The SSCC is used with EDI communications to enable identification and traceability.

Rules

Not applicable.

Data carrier specification**Carrier choices**

The mandatory data carrier used to represent individual logistic units is the GS1-128 barcode symbology.

A GS1 DataMatrix or GS1 QR Code symbol MAY be included in addition to the GS1-128 symbol. When used, the 2D barcode SHALL include all element strings included in the GS1-128 symbol(s), and MAY include additional element strings.

If a logistic unit does not have at least one surface area greater than an A6 or 4" x 6" logistic label (see section [6.6.4.5](#)), a GS1 DataMatrix or GS1 QR Code MAY be used by itself on a logistic label, though a GS1-128 containing a SSCC is still recommended. If a logistic label is used with only a GS1 DataMatrix or GS1 QR Code, care must be taken to ensure trading partners are able to scan this barcode.

For healthcare, see the recommendations at the end of section [2.1.5](#) in figure [2.1.5-2 Carrier choices](#).

Symbol X-dimensions, minimum symbol height, and minimum symbol quality

See section [5.12.3.5](#), *GS1 symbol specification table 5*.

Symbol placement

All the symbol placement guidelines defined in section [6](#).

Unique application processing requirements

For a description of processing requirements, see section [7](#).

2.2.2 Multiple logistic units – Global Identification Number for Consignment**Application description**

- Consignments can comprise one or many logistic units. If the consignment comprises more than one physical object there is no requirement that they are attached together. A consignment number identifies a logical grouping. When a consignment number is read the message is that this physical unit should be associated with any other physical units carrying the same consignment number. Individual physical units carry the SSCC as described in the previous section.
- The Global Identification Number for Consignment is assigned by the freight forwarder or carrier of the transport units and is referenced in the relevant transport messages and documents (e.g., waybill). It may be used as a communication reference by all parties in the transport chain, such as in Electronic Data Interchange (EDI) messages where it can be used as a consignment reference and/or freight forwarders or carriers loading list. See section [3.2](#), Global Identification Number for Consignment (GINC): AI (401).



Note: Shipment and consignment are terms, which may be used interchangeably within the transport and logistics sector however for the purposes of clarity, when referring to multiple logistic unit identification for trade, GS1 uses the term shipment and when referring to multiple logistic unit identification for transport, GS1 uses the term consignment

GS1 key

Required

GINC

The GS1 Application Identifier for the GINC is AI (401), see section [3.2](#)

Rules

The data transmitted means that the element string denoting a Global Identification Number for Consignment has been captured. The Global Identification Number for Consignment may be processed as stand-alone information where applicable or with other identification data appearing on the same unit. See sections [2.2.1](#) and [6.6](#) for the use of the GINC in combination with the SSCC.

Attributes

Required

Not applicable

Optional

Not applicable

Data carrier specification

Carrier choices

The data carriers used to represent the Global Identification Number for Consignment are the GS1-128 barcode and the GS1 DataMatrix and GS1 QR Code symbologies.

Symbol X-dimensions, minimum symbol height and minimum symbol quality

See section [5.12.3.5](#), *GS1 symbol specification table 5*.

Symbol placement

All the symbol placement guidelines defined in section [6](#).

Unique application processing requirements

For a description of processing requirements, see section [7](#).

2.2.3 Multiple logistic units – Global Shipment Identification Number

Application description

- Shipments can comprise one or many logistic units. If the shipment comprises more than one physical object there is no requirement that they are attached together. A shipment number identifies a logical grouping. When a shipment number is read the message is that this physical unit should be associated with any other physical units carrying the same shipment number. Individual physical units carry the SSCC as described in the previous section.
- The Global Shipment Identification Number (GSIN) is assigned by a seller (sender) of the goods and is referenced in the despatch advice and bill of lading, etc. It is a globally unique number that identifies a logical grouping of physical units in a transport shipment. It may be used as a communication reference by all parties in the transport chain, such as in Electronic Data Interchange (EDI) messages where it can be used as a shipment reference and/or a consignor's loading list.



Note: Shipment and consignment are terms which may be used interchangeably within the transport and logistics sector, however for the purposes of clarity, when referring to multiple logistic unit identification for trade, GS1 uses the term shipment and when

referring to multiple logistic unit identification for transport, GS1 uses the term consignment.

GS1 key

Required

GSIN

The GS1 Application Identifier for the GSIN is AI (402), see section [3.2](#).

Rules

The data transmitted means that the element string denoting a shipment identification number has been captured. The Global Shipment Identification Number may be processed as stand-alone information where applicable or with other identification data appearing on the same unit. See sections [2.2.1](#) and [6.6](#) for the use of the GSIN in combination with the SSCC.

Attributes

Required

Not applicable

Optional

Not applicable

Data carrier specification

Carrier choices

The data carriers used to represent the Global Shipment Identification Number are the GS1-128 barcode and the GS1 DataMatrix and GS1 QR Code symbologies.

Symbol X-dimensions, minimum symbol height and minimum symbol quality

See section [5.12.3.5](#), *GS1 symbol specification table 5*.

Symbol placement

All the symbol placement guidelines defined in section [6](#).

Unique application processing requirements

For a description of processing requirements, see section [7](#).

2.3 Assets

The GS1 system provides a method for the identification of assets. The object of asset identification is to identify a physical entity as an inventory item.

Each company holding a GS1 Company Prefix may assign a Global Returnable Asset Identifier (GRAI) or Global Individual Asset Identifier (GIAI). If the asset is manufactured on behalf of a company best practice may dictate that the manufacturing company applies the GRAI or GIAI during the manufacturing process on behalf of this customer.



Note: Where assets of the same type need to be ordered a GTIN is required for the ordering process. There is no conflict when a GTIN and a GRAI (GS1 Company Prefix, asset type and check digit) have the same digits, because the data carrier (EDI qualifier, GS1 barcode with GS1 Application Identifier, or EPC/RFID) will distinguish between the two GS1 identification keys.

The GS1 asset identifiers act as keys to access the characteristics of an asset stored in a computer file and/or to record movements of assets.

- ✔ **Note:** The attributes of the asset should be recorded and shared digitally using the GS1 asset identifier as the key to the information. Examples of the type of information held include the party who owns the asset, the value of the asset, the location of the asset and the life cycle history of the asset.

Asset identifiers may be used for basic applications, such as the location and usership of a given asset (e.g., a personal computer or returnable transport item) or for complex applications, such as recording the characteristics of a returnable asset (e.g., a reusable beer keg), its movements, its life cycle history and any relevant data for accounting purposes.

2.3.1 Global Returnable Asset Identifier (GRAI): AI (8003)

Application description

A returnable asset is a reusable package or transport equipment of a certain value, such as a beer keg, a gas cylinder, a plastic pallet, or a crate. The GS1 system identification of a returnable asset, the Global Returnable Asset Identifier (GRAI), enables tracking as well as recording of all relevant data.

The GRAI is composed of the GS1 Company Prefix (of the company assigning the asset identifier) and the asset type. The latter is assigned to uniquely identify, together with the GS1 Company Prefix, a particular kind of asset. The GRAI remains the same for all identical returnable assets. Although consecutive numbering is recommended, the structure is left to the discretion of the assigning company. An optional serial component may be used to distinguish individual assets within a given asset type.

A typical application using this element string is in tracking returnable beer kegs. The owner of the beer keg applies a barcode carrying a GRAI to the keg using a permanent marking technique. This barcode is scanned whenever the keg is supplied full to a customer and scanned again when it is returned. This scanning operation allows the beer keg owner to automatically capture the life cycle history of a given keg and to operate a deposit system, if desired.

- ✔ **Note:** This element string identifies a physical entity as a returnable asset. When such a physical entity is used to transport or to contain a trade item, the element string AI (8003) must never be used to identify the transported or contained trade item.
- ✔ **Note:** GS1 refers to the GRAI in section [2.1.8](#), which deals the Automatic Identification and Data Capture (AIDC) of medical devices within the micro-logistics cycle of use, cleaning and sterilisation. See section [2.1.8](#) for more details.

GS1 key

Required

GRAI

The GS1 Application Identifier to indicate the Global Returnable Asset Identifier (GRAI) is AI (8003), see section [3.2](#).

Rules

See section [4.4](#).

Attributes

Required

Not applicable

Optional

For all the GS1 Application Identifiers that may be used with a GRAI, see section [3.2](#).

Data carrier specification

Carrier choices

The GS1 data carriers that can be used to represent the GRAI are:

- GS1-128
- GS1 DataMatrix
- GS1 QR Code
- EPC/RFID

When encoding an asset identifier for medical devices see section [2.1.8](#).

When applying permanent marking, also see the information in section [2.6.14](#).

Symbol X-dimension, minimum symbol height and minimum symbol quality

For GS1-128, GS1 DataMatrix and GS1 QR Code, see section [5.12.3.9](#) *GS1 symbol specification table 9* and section [5.12.3.7](#) *GS1 symbol specification table 7* (direct part marking) or section [5.12.3.13](#) *GS1 symbol specification table 13* (long distance scanning).

Symbol placement

Not applicable.

Unique application processing requirements

For a description of processing requirements, see section [7](#).

2.3.2 Global Individual Asset Identifier (GIAI): AI (8004)

Application description

In the GS1 system, an individual asset is considered a physical entity made up of any characteristics.

This element string identifies a particular physical entity as an asset. It must not be used for other purposes and must be unique for a period well beyond the lifetime of the relevant asset records. Whether or not the assigned Global Individual Asset Identifier (GIAI) may remain with the asset when changing hands depends on the particular business application. If it remains with the asset it SHALL NOT be reused.

The GIAI comprises the GS1 Company Prefix of the company assigning the asset identifier and an individual asset reference (see section [3](#)). The individual asset reference is alphanumeric. Its structure is left to the discretion of the asset owner or manager.

This element string might, for example, be used to record the life cycle history of aircraft parts. By symbol marking the GIAI, AI (8004), on a given part, aircraft operators are able to automatically update their inventory database and track assets from acquisition until retirement.

GS1 refers to GIAI in the section [2.1.8](#), which deals with Automatic Identification and Data Capture (AIDC) for medical devices within the micro-logistics cycle of use, cleaning and sterilisation. See section [2.1.8](#) for more details.

GS1 key

Required

GIAI

The GS1 Application Identifier to indicate the Global Individual Asset Identifier (GIAI) is AI (8004), see section [3.2](#).

- ✓ **Note:** The GIAI of assemblies (composite components) may need to be marked on a component of the assembly (the so called leading part) when there is no dedicated space to mark the GIAI on the assembly itself. For example, the GIAI of a *side buffer* of a rail vehicle may be included in a separate marking on the *buffer casing*, in addition to the marking of the *buffer casing* itself. To be able to recognise the marking of the assembly AI (7023) SHALL be used to indicate the GIAI of the assembly.

Figure 2.3.2-1. Example: Side buffer (assembly) with buffer casing (leading part)

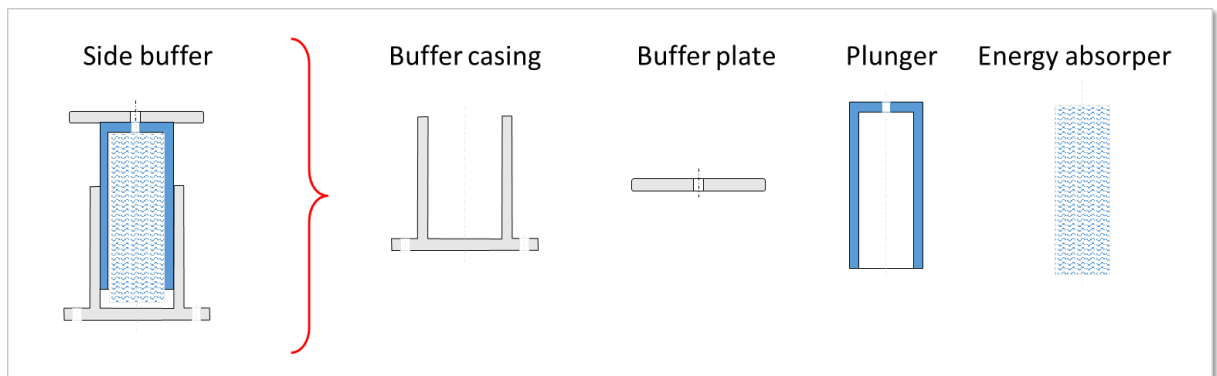

Rules

See section [4.4](#)

Attributes

Required

Not applicable

Optional

For all the GS1 Application Identifiers that may be used with a GIAI, see section [3.2](#).

Data carrier specification

Carrier choices

The GS1 data carriers that can be used to represent the GIAI are:

- GS1-128
- GS1 DataMatrix
- GS1 QR Code
- EPC/RFID

When encoding an asset identifier for medical devices see section [2.1.8](#).

When applying permanent marking, also see the information in section [2.6.14](#).

Symbol X-dimension, minimum symbol height and minimum symbol quality

For GS1-128, GS1 DataMatrix and GS1 QR Code, see section [5.12.3.9](#) *GS1 symbol specification table 9* and section [5.12.3.7](#) *GS1 symbol specification table 7* (direct part marking), or section [5.12.3.13](#) *GS1 symbol specification table 13* (long distance scanning).

Symbol placement

Not applicable

Unique application processing requirements

For a description of processing requirements, see section [7](#).

2.4 Parties and locations

The GLN is a globally unique and unambiguous GS1 identification key that can identify of any type of party or location used in business processes. The use of Global Location Numbers (GLNs) is driven by the exact role of each party and/or location within a given business process.

A GLN identifying a party answers the question of “who” is involved within the use case. This may be a legal entity or function transacting in a business scenario.

- **Legal entity** – Any business, government body, department, charity, individual or institution that has standing in the eyes of the law and has the capacity to enter into agreements or contracts.
- **Function** – An organisational subdivision or department based on the specific tasks being performed, as defined by the organisation.

A GLN identifying a location is used to answer the question of “where” something has been, is, or will be. A location can be either physical or digital in nature.

- **Physical location** - A site (an area, a structure or group of structures) or an area within the site where something was, is, or will be located.
 - The identification of physical locations is an essential element for supply chain visibility. A GLN assigned to a physical location always has identifiable geographical location reference (e.g., address, geocoordinates) regardless of any business process roles conducted at the site. A physical location may be permanent and remain in a fixed position or mobile where the position can change over time (i.e., mobile blood donation van).
- **Digital location** - An electronic (non-physical) address that is used for communication between computer systems.
 - Just as the exchange of physical goods is a transaction between companies, the exchange of data is a transaction between systems, for example the delivery of an invoice can be mapped to an EDI gateway identified by a GLN.

For rules on GLN allocation, see the [GS1 GLN Allocation Rules Standard](#).

2.4.1 Application overview

The GLN is used in applications that share party and location information through automatic identification and data capture (AIDC). Section [2.4](#) focuses on the use of the GLN in AIDC applications. Four broad categories of use of the GLN exist:

1. Identification of a physical location, for example through a label attached to a loading dock or to a shelf location in a warehouse.
2. Specification of a location used in transport and logistics processes, for example a ship to location on a logistic label.
3. Identification of a party, for example designating a legal entity on a document.
4. Specification of a party, for example the invoicing party on a payment slip.

GLN is widely used to share data between systems and is a foundational key in the related GS1 standards. For further information, please consult the relevant GS1 standard.

1. Electronic Data Interchange (EDI) uses GLN to identify trading partners and physical locations involved in transactions. Also, the EDI mailbox or network address for companies is often identified with a GLN.

2. Global Data Synchronisation Network (GDSN) mandate the use of GLNs to identify each party that provides information to any data pool and who requires information about products and locations.
3. Electronic Product Code Information Services (EPCIS) uses GLN to identify involved parties, read points and business locations for capturing and sharing visibility data. For example, a mobile location identified by a GLN can be tracked using the EPCIS standard.

2.4.2 Identification of a physical location

Application description

The following GS1 Application Identifiers enable the identification of a physical location using a data carrier present at the location itself:

- AI (414) Physical location
- AI (254) GLN extension component

AI (414) Physical location

The GLN can be used to identify a physical location represented in a data carrier on the location itself. Physical locations may, for example, be a room, a door of a warehouse, an x-ray room in a hospital, or a control point.

The element string may be used to record and confirm presence at a given location for any purpose. An equivalent field will hold this information in electronic messages.

AI (254) GLN extension component

Business processes cause objects (e.g., products, assets, or other equipment) to move from one physical location to another. The ability to have visibility of these movements is an essential element in any supply chain. These physical locations can be a site such as a distribution centre or a specific location within the site such as a selling floor, a room in a hospital or a yard of a warehouse; it can even be as granular as a specific area on a shelf.

The GLN extension component may be used to identify internal physical locations within a location identified with a GLN, known as sub-locations. A company can alternatively choose to assign a unique GLN, without an extension component, to identify these sub-locations.

The figure below provides an example of how GLN extension component may be used.

Figure 2.4.2-1. Physical locations in a logistic process

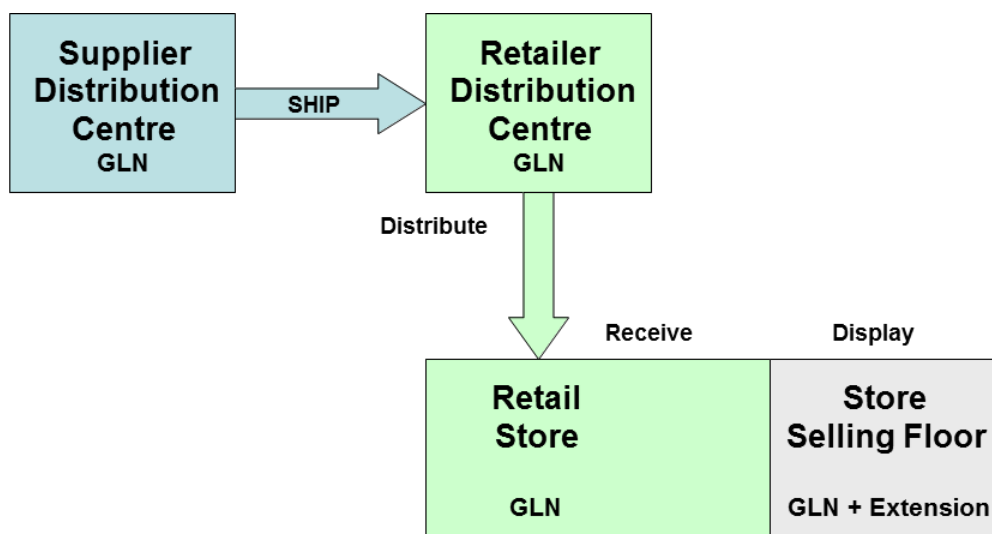

Important:

- A GLN extension component SHALL only be used in conjunction with a GLN identifying a physical location.

- The GLN extension component SHALL only be used in applications where there is mutual agreement between all involved trading partners and where the standard being used supports the GLN extension component.
- If the GLN + GLN extension component are used to identify locations within the site, each sub-location identification SHALL follow the GLN Management Rule defined in the [GS1 GLN Allocation Rules Standard](#).

GS1 key

Required

- GLN

Rules

GLN rules described in section [4.5](#).

Attributes

Required

Not applicable

Optional

The GS1 Application Identifier (254) may be used to represent the GLN extension component in conjunction with AI (414).

For more information, see section [3.2](#) for the list of GS1 Application Identifiers.

Rules

See section [4.13](#) *Data relationships* for definitions of invalid pairs and mandatory associations of element strings.

Data carrier specification

Carrier choices

The GS1 data carriers that can be used to represent the GLN or GLN + GLN extension component are:

- GS1-128
- GS1 DataMatrix
- GS1 QR Code
- EPC/RFID



Note: GS1's [EPC Tag Data Standard](#) (TDS) defines the SGLN as a Global Location Number (GLN), with or without the optional extension AI (254), which is used to identify physical locations. Examples of such locations include a specific building or unit of shelving within a warehouse. For more information on EPC carriers see the [EPC Tag Data Standard](#).

Symbol X-dimension, minimum symbol height and minimum symbol quality

See section [5.12.3.9](#), *GS1 symbol specification table 9*.

Symbol placement

Not applicable

Unique application processing requirements

For a description of processing requirements, see section 7.

2.4.3 Physical locations in business processes

Application description

The following GS1 Application Identifiers enable the specification of a physical location on a label or document, relative to its role in a business process:

- AI (410) Ship to - Deliver to
- AI (413) Ship for - Deliver for
- AI (416) Production or service location

AI (410) Ship to - Deliver to

An element string with GS1 Application Identifier AI (410) represents the Global Location Number (GLN) of the recipient of a logistic unit. The GLN refers to the address where a particular transport unit identified with an SSCC is to be delivered. This element string is used in single leg transport operations. A logistic unit may include a barcode carrying the GLN of the unit’s intended destination. When scanning this element string, the data transmitted may be used to retrieve the related address and/or to sort the item by destination.

AI (413) Ship for - Deliver for

An element string with GS1 Application Identifier AI (413) is used by the consignee for determining the internal or subsequent final destination of a physical unit.

Cross docking is a typical application using this element string. Here, a barcode carrying the element string AI (410) is placed on a logistic unit at the point of creation to direct the goods to the intermediate destination (e.g., a distribution centre). The element string AI (413) is also carried by the barcode to direct the goods to their final destination (e.g., a retail store served by the distribution centre).

Figure 2.4.3-1. Example of a cross docking application

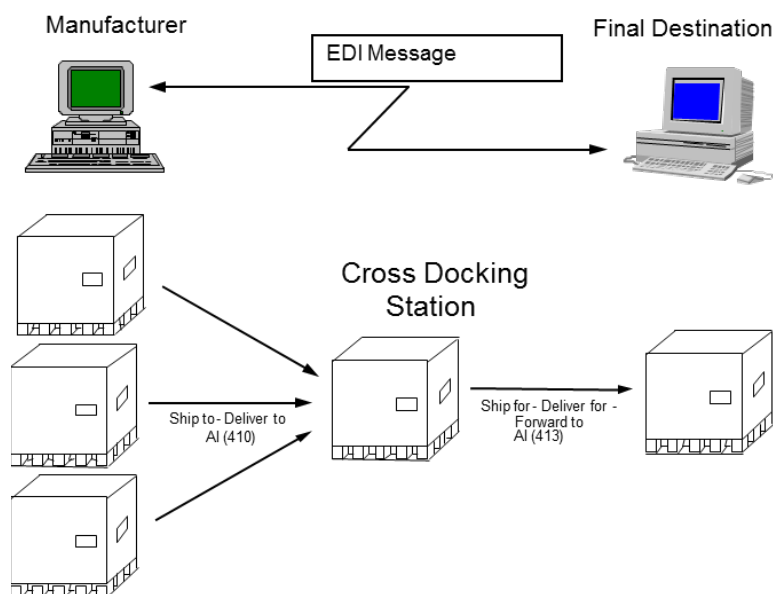

AI (416) GLN of the production or service location

An element string with a GS1 Application Identifier AI (416) represents the Global Location Number (GLN) of the production or service location. It may for example be used to specify the location where a trade item or asset was produced or refurbished.

GS1 key**Required**

GLN

RulesAll GLN rules described in section [4.5](#).**Attributes**

Not applicable

Data carrier specification

If the GLN is carried in a barcode or EPC/RFID tag on a product, the rules for trade item applications apply, see section [2.1](#).

If the GLN is carried in a barcode on a GS1 Logistics Label, the rules for logistic unit applications apply, see section [2.2](#).

Unique application processing requirementsFor a description of processing requirements, see section [7](#).**2.4.4 Identification of a party****Application description**

GS1 Application Identifier (417) enables the identification of a party using a data carrier.

AI (417) Party GLN

The GLN can be used to identify a party represented in a data carrier on documents, locations, or other places where value could be added. Parties may, for example, legal entity, government body, accounting department, or other business function.

The element string may be used to record and confirm presence of a party for any purpose. An equivalent field will hold this information in electronic messages.

GS1 key**Required**

GLN

RulesAll GLN Rules described in section [4.5](#).**Attributes****Required**

Not applicable

OptionalFor more information, see section [3.2](#) for the list of GS1 Application Identifiers.**Rules**See section [4.13](#) *Data relationships*.

Data carrier specification

Carrier choices

The GS1 data carriers that can be used to represent the GLN are:

- GS1-128
- GS1 DataMatrix
- GS1 QR Code
- EPC/RFID

✔ **Note:** GS1's [EPC Tag Data Standard](#) (TDS) defines the PGLN as a Global Location Number (GLN) for a party. Examples of such parties include an economic operator or a cost centre. For more information on EPC carriers see the [EPC Tag Data Standard](#).

Symbol X-dimension, minimum symbol height and minimum symbol quality

See section [5.12.3.9](#), *GS1 symbol specification table 9*.

✔ **Note:** For location marking barcodes may be printed at a higher maximum X-dimension: GS1-128 at 1.016 mm (0.0400 inches), GS1 DataMatrix and GS1 QR Code at 1.520 mm (0.0600 inches).

Symbol placement

Not applicable

Unique application processing requirements

For a description of processing requirements, see section [7](#).

2.4.5 Parties in business processes

Application description

The following GS1 Application Identifiers enable the specification of a party on a label or document, relative to its role in a business process:

- AI (411) Bill to - Invoice to
- AI (412) Purchased From
- AI (415) Invoicing Party
- AI (703*) Approval Number of processor (with ISO country code '999')

AI (411) Bill to – Invoice to

An element string with GS1 Application Identifier AI (411) represents the Global Location Number (GLN) of the addressee of an invoice. The GLN refers to the name and address of the business partner to which an entity shall be invoiced and includes accounting-related information that may be used wherever required.

AI (412) Purchased from

In business it is sometimes important to know from where a particular item was purchased. Applied on a trade item, an element string with GS1 Application Identifier AI (412) provides the Global Location Number (GLN) of the company from which the respective trade item has been purchased.

AI (415) Invoicing party

An element string with GS1 Application Identifier AI (415) is used to indicate the Global Location Number (GLN) of the invoicing party. The GLN is mandatory information for the payment slip application (see section [2.6.6](#)).

AI (703*) Number of processor

An element string with GS1 Application Identifier (703s) represents the ISO country code and approval number or GLN of the processor of a trade item. If '999' is entered as the ISO country code it signifies that the subsequent data is a Global Location Number (GLN), and not an 'approval number'.

As an attribute of a trade item the number of processor must be processed together with the GTIN of the trade item to which it relates. See section [3.8.17](#) for more information.

GS1 key

Required

GLN

Rules

All GLN rules described in section [4.5](#).

Attributes

Not applicable

Data carrier specification

If the GLN is carried in a barcode on a GS1 Logistic Label, the rules for logistic unit applications apply, see section [2.2](#).

If the GLN is carried in a barcode on a payment slip the rules for the payment slips application apply, see section [2.6.6](#).

Unique application processing requirements

For a description of processing requirements, see section [7](#).

2.5 Service relationships

Application description

The Global Service Relation Number (GSRN) is a non-significant number used to identify the relationship between an organisation offering services and the individual entities providing or benefitting from the services. The GSRN provides unique and unambiguous identification. It is the key to accessing information, stored on computer systems, relevant to service(s) provided and received and in some cases, these services could be recurring. The GSRN may also be used for referencing information transferred via Electronic Data Interchange (EDI).

When using the GSRN, often two types of relationships may need to be captured in one transaction:

1. The relationship between the organisation offering the service and the actual recipient of the service.
2. The relationship between the organisation offering the service and the actual provider of the service.

It should be noted that the GSRN is not meant to identify a single service as a trade item, neither is it used to identify a physical unit as a trade item. It may identify a physical unit for service purposes (e.g., a computer with a service agreement).

2.5.1 Global Service Relation Number – Provider: AI (8017)

An element string with GS1 Application Identifier AI (8017) represents the Global Service Relation Number of a relationship between the organisation offering the service and the provider of the service. Some examples of how the GSRN can be used to identify the service relationships are:

- A medical procedure, where it could be used to identify an individual medical provider by role. For identification of the individual provider of care, the hospital or the appropriate authority generates a GSRN with AI (8017) for each of its caregivers and encodes it in an appropriate GS1 Data carrier (barcode) symbol on the caregiver's ID card, work station, work order, etc. In this case, the GSRN would ensure non-significant identification management, securing identification uniqueness and also allowing linkage to local rule management systems.
- A service agreement, where it could be used to manage agreed upon services, such as maintenance services for a television or computer.
- A loyalty program required to identify the service relationship between the loyalty program and the service provider (i.e. company providing merchandise due to use of loyalty points).
- A hospital administration can identify the service relationship between hospital and the doctor, nurses, etc.

GS1 key

Required

GSRN

The GS1 Application Identifiers to indicate, *Global Service Relation Number(GSRN) are AI (8017) and AI (8018)* , see section [3.2](#)

Rules

All GSRN rules described in section [4.6](#).

Attributes

Required

Not applicable

Optional

AI (7241) AIDC media type, section [3.2](#)

AI (7242) Version Control Number (VCN), section [3.2](#)

AI (7253) Family name of person, section [3.2](#)

AI (7254) Given name of person, section [3.2](#)

AI (7255) Name suffix of person, section [3.2](#)

AI (7256) Full name of person, section [3.2](#)

AI (8019) Service Relation Instance Number, section [3.2](#)

AI (8030) Digital Signature (DigSig), section [3.2](#)

Rules

Not applicable

Data carrier specification

Carrier choices

The data carrier choices for this application are:

- GS1 DataBar Expanded

- GS1 DataBar Expanded Stacked
- GS1-128
- GS1 DataMatrix
- GS1 QR Code

Symbol X-dimension, minimum symbol height and minimum symbol quality

See section [5.12.3.11](#), *GS1 symbol specification table 11*

Symbol placement

No standard placement is required.

Unique application processing requirements

For a description of processing requirements, see section [7](#).

2.5.2 Global Service Relation Number – Recipient: AI (8018)

An element string with GS1 Application Identifier AI (8018) represents the Global Service Relation Number of a relationship between the organisation offering the service and the recipient of the service. Some examples of how the GSRN can be used to identify the service relationships are:

- A hospital admission, where it could be used to identify a subject of care globally and uniquely for AIDC purposes and establish an identification uniqueness that does not harm privacy. For identification of the subject of care (patient) the hospital generates a GSRN with AI (8018) for each of its patients and encodes it in an appropriate GS1 Data carrier (barcode) on the patient's wristband as well as his or her corresponding medical record, pathology samples, etc. The GSRN may then be used as the key to link multiple or specific instances of treatment, room charges, medical tests and patient charges.
- A membership in a frequent flyer programme, where it could be used to record awards, claims and preferences.
- A membership in a loyalty scheme, where it could be used to record visits, purchase value and awards.
- A membership in a club, where it could be used for recording entitlements, use of facilities and subscriptions.
- A loyalty program required to identify the service relationship between the loyalty program and the recipient of the loyalty program (the end user or customer who earns loyalty points).
- Patient admission to a hospital can identify the service relationship between the hospital and the patient.
- Utility networks, such as those providing electricity, gas or water, where it could be used to identify the relationship between network service providers and suppliers of utility products.
- A GSRN could be used to give students access to other libraries that have formed a cooperative lending agreement. A typical application is the identification of membership in a student library. The library would issue all members a card that includes a unique GSRN identifying the relationship between the library and a student. The library would then scan the GSRN whenever a book was lent or returned. The Electronic Message from the scanner would then be used to automatically update the library's stock management database. See the figure below for an example of how the service relationship identifier would appear on this membership card.

Figure 2.5.2-1. Example of GSRN on a membership card

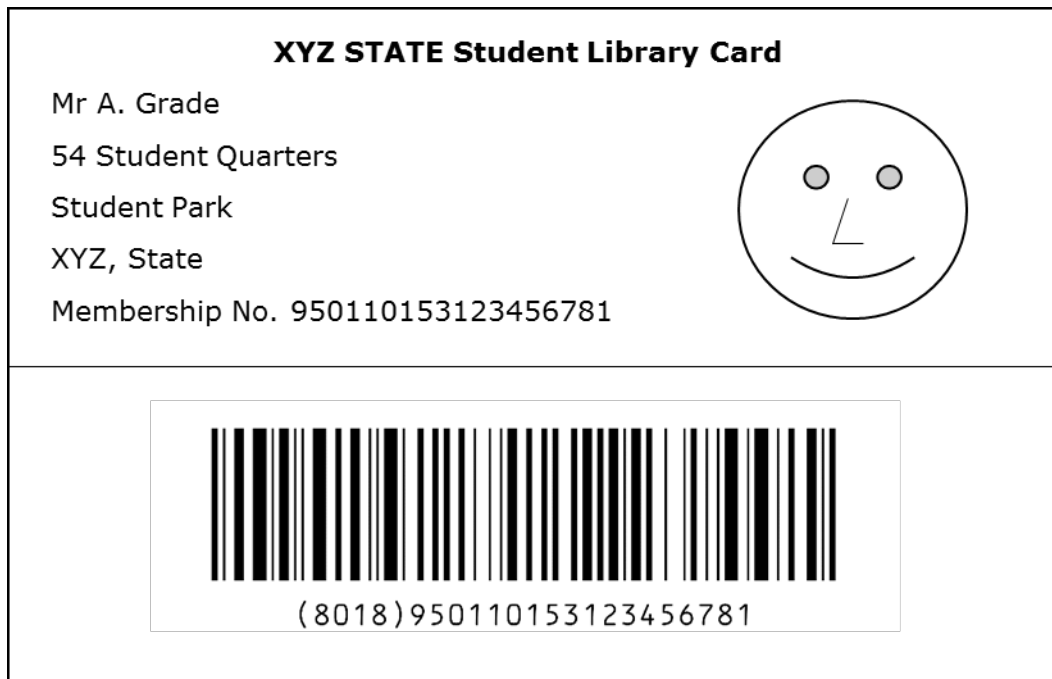

GS1 key

Required

GSRN

See section [3.2](#), *Global Service Relation Number AI (8017) and AI (8018)* for the definition of the GS1 Application Identifier.

Rules

See section [4.6](#), *GSRN rules*.

Attributes

Required

Not applicable

Optional

AI (8019) Service Relation Instance Number, section [3.2](#)

AI (7241) AIDC media type, section [3.2](#)

AI (7242) Version Control Number, section [3.2](#)

AI (8030) Digital Signature (DigSig), section [3.2](#)

AI (7250) Date of birth, section [3.2](#)

AI (7251) Date and time of birth, section [3.2](#)

AI (7252) Biological sex, section [3.2](#)

AI (7253) Family name of person, section [3.2](#)

AI (7254) Given name of person, section [3.2](#)

AI (7255) Name suffix of person, section [3.2](#)

AI (7256) Full name of person, section [3.2](#)

AI (7257) Address of person, section [3.2](#)

AI (7258) Baby birth sequence indicator, section [3.2](#)

AI (7259) Baby of family name, section [3.2](#)

Rules

Not applicable

Data carrier specification

Carrier choices

The data carrier choices for this application are:

- GS1 DataBar Expanded
- GS1 DataBar Expanded Stacked
- GS1-128
- GS1 DataMatrix
- GS1 QR Code

Symbol X-dimension, minimum symbol height and minimum symbol quality

See section [5.12.3.11](#), *GS1 symbol specification table 11*

Symbol placement

No standard placement is required.

Unique application processing requirements

For a description of processing requirements, see section [7](#).

2.5.3 Service Relation Instance Number: AI (8019)

A service provider or a service recipient can be identified with a Global Service Relation Number (GSRN), using AI (8017) and (8018) respectively. If the service provider or recipient identification needs to, optionally, be made more granular with a sequence indicator corresponding to each encounter during the service relationship, attribute data in the form of a Service Relation Instance Number (SRIN AI (8019), see section [3.2](#)), may be added.

For example, when a GSRN is encoded to a data carrier and applied to a patient wristband to identify the patient as a recipient of care, each SRIN linked to the patient's GSRN can correspond to a specific instance or encounter within an episode of care for that patient. For treatments which may require multiple instances of care and a record to be captured for each instance, such as for chemotherapies, the SRIN linked to the GSRN may be used. Furthermore, when a product or service is administered (e.g., a particular treatment is given) it can easily be associated with the patient and the corresponding instance of care, by scanning the Global Trade Item Number (GTIN) of the product or service, then associating it to the patient's GSRN and the related SRIN, as well as the caregiver's GSRN.



Important: Prior to the development of the Version Control Number (VCN) AI (7242), the SRIN could also be optionally used with a GSRN as a sequence indicator for version control purposes. Use of the SRIN in this manner is only possible when there are no other requirements to further qualify and identify a specific instance of service. For new version control requirements, the VCN SHALL be used instead of the SRIN (see section [3.8.24](#)).

2.5.4 Use of demographic data to support verification or validation of personal identity

Application description

The use of demographic information is an additional mechanism to support the validation and verification of both the subject of care (patient) and provider of care (caregiver) in a consistent way. When used alongside both the Global Service Relation Number (GSRN) and optionally the Service Relation Instance Number (SRIN) as well this information provides greater surety of identity. Demographic information refers to all non-clinical data about a subject of care (patient) or provider of care (caregiver), including: family name, given name, date of birth, address, biological sex and more.

Subject of care (patient) and provider of care (caregiver) demographic data is typically stored in Electronic Health Record (EHR), Electronic Medical Record (EMR) or Electronic Patient Record (EPR) systems within a hospital healthcare environment.

! **Important Patient Privacy Note:** As GS1 does not allocate a globally unique identifier for patients and no patient or caregiver data is stored and maintained by GS1, patient and caregiver identification and privacy responsibility SHALL remain with the organisation delivering the care and identifying the relationship between its care providers and patients.

GS1 key

Required

GSRN

The GS1 Application Identifiers to indicate:

Global Service Relation Number (GSRN) are AI (8017) for Provider of Care Identity Validation and AI (8018) for Subject of Care Identity Validation, see section [3.2](#)

Rules

All GSRN rules described in section [4.6](#)

Attributes

Required

Not applicable

Optional

Provider of Care Identity Validation

AI (8019) Service Relation Instance Number, section [3.2](#)

AI (7241) AIDC media type, section [3.2](#)

AI (7242) Version Control Number, section [3.2](#)

AI (7253) Family name of person, section [3.2](#)

AI (7254) Given name of person, section [3.2](#)

AI (7255) Name suffix of person, section [3.2](#)

AI (7256) Full name of person, section [3.2](#)

Subject of Care Identity Validation

AI (8019) Service Relation Instance Number, section [3.2](#)

AI (7241) AIDC media type, section [3.2](#)

AI (7242) Version Control Number, section [3.2](#)

AI (7250) Date of birth, section [3.2](#)

AI (7251) Date and time of birth, section [3.2](#)

- AI (7252) Biological sex, section [3.2](#)
- AI (7253) Family name of person, section [3.2](#)
- AI (7254) Given name of person, section [3.2](#)
- AI (7255) Name suffix of person, section [3.2](#)
- AI (7256) Full name of person, section [3.2](#)
- AI (7257) Address of person, section [3.2](#)
- AI (7258) Baby birth sequence indicator, section [3.2](#)
- AI (7259) Baby of family name, section [3.2](#)

Rules

Not applicable

Data carrier specification**Carrier choices**

The data carrier choice for this application are:

- GS1 DataMatrix
- GS1 QR Code

Symbol X-dimension, minimum symbol height and minimum symbol quality

See section [5.12.3.11](#), GS1 symbol specification table 11

Symbol placement

No standard placement is required.

Unique application processing requirements

For a description of processing requirements, see section [7](#).

2.6 Special applications

2.6.1 Coupons

A coupon is a digital or paper-based voucher that can be redeemed at the point-of-sale for a cash value or free item. Coupon identification is organised at the local level. Determining the data structure of a coupon is, therefore, the responsibility of the GS1 Member Organisations for their area of jurisdiction.

The purpose of coupon numbering and symbol marking is to automate and speed up coupon handling procedures at the point-of-sale. Moreover, coupon issuers and retailers may be able to reduce the costs involved in sorting coupons, administering manufacturers' payments and producing reports on redemption.

All GS1 system coupon standards presented here allow for coupon validation (e.g., to check whether the item(s) covered by the coupon is within the customer's order).

If either validation or value look up is performed, manufacturers must advise their distributors and retailers of the impending issue of a coupon so that retailers' files can be updated to process the information at the point-of-sale.

A GS1 system coupon number is used for numbering promotional coupons for manufacturers and retailers as well as tokens with monetary value, such as gift tokens, book tokens, food stamps, luncheon vouchers and social security tokens.

The structure of GS1 system coupon numbers ensures uniqueness against all other GS1 system numbers only when used within the monetary area of the appropriate GS1 Member Organisation(s).

2.6.2 Coupons identified using the Global Coupon Number

2.6.2.1 Paper coupons

Application description

A paper coupon is a physical representation that is distributed and presented in hard-copy form, and can be exchanged for a financial discount or for loyalty points when making a purchase.

Paper coupons may be identified by a Global Coupon Number (GCN) assigned by the coupon issuer. The GCN comprises a GS1 Company Prefix followed by a coupon reference. It may be supplemented by an optional serial number.

Before implementing the Global Coupon Number to identify paper coupons, it is advised that the issuer of the coupons confirm the acceptance of the Global Coupon Number with their trading partners. Several options exist for coupons with restricted geographic distribution that may be preferred method of identifying coupons, see section [2.6.3](#).

GS1 key

Required

GCN

The GS1 Application Identifier to indicate the Global Coupon Number (GCN) is AI (255) (see section [3.2](#)).

Rules

All the GCN application rules described in section [4](#).

Attributes

Required

Not applicable

Optional

To provide additional information to the Global Coupon Number, the following AIs can be used: AI (17) Expiration date, AI (390N) Coupon value – Single monetary area or AI (394n) Percentage discount of a coupon or AI (8111) Loyalty points of a coupon (see section [3](#)).

For all the GS1 Application Identifiers that may be used with an GCN, see section [3.2](#)

Data carrier specification

Carrier choices

GS1 DataBar

Symbol placement

Not applicable

Examples

Example 1 Coupon with GCN



Coupon barcode contains AI (255) GCN (serialised) which serves as database access to all relevant coupon data.

Example 2 Coupon with GCN and free gift amount



Coupon barcode contains AI (255) GCN (serialised) and AI (3900) AMOUNT with value "000" which indicates a free gift. In order to process this coupon value correctly as free gift the till software needs to be adjusted accordingly.

Example 3 Coupon with GCN, expiration date and coupon value



Coupon barcode contains AI (255) GCN, AI (17) EXPIRY and AI (3902) AMOUNT (two decimals)

Example 4 Coupon with GCN and loyalty points

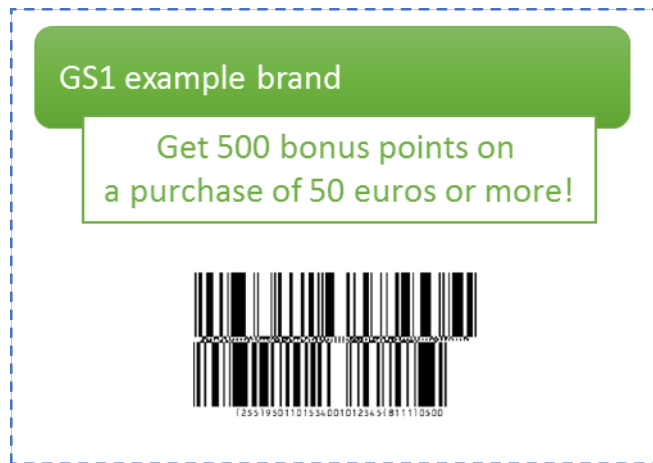

Coupon barcode contains AI (255) GCN (serialised) and AI (8111) POINTS

Example 5 Coupon with GCN and percentage discount



Coupon barcode contains AI (255) GCN and AI (3941) PRCNT OFF (one decimal)

2.6.2.2 Digital coupons

Application description

A digital coupon is an electronic presentation that is distributed and presented without manifesting as “paper” or in other hard-copy form and can be exchanged for a financial discount or for loyalty points when making a purchase. GS1 global standards enable efficient digital coupon processes for the benefit of:

Brands who can execute offers in the same way in multiple countries and with multiple retailers. Brands can have more relevant/targeted marketing and campaign opportunities tied to specific factors (ex. Location, consumer, products, interest and interaction with media).

Mobile industry and solution providers who will have a baseline and one standard to implement rather than multiple.

Retailers who can accept offers from coupon issuers in one rather than multiple ways and can understand how to configure (and possibly upgrade) the POS system. Retailers can also accept digital coupons acquired from multiple distributions channels, process them in a uniform and standard way, and integrate where appropriate with their loyalty system.

Consumers who will have a consistent and a satisfying experience when they manage their coupon offers (digital coupons are searchable, sort-able, allowing customers to browse by merchant, category, offer date and other criteria).

The following diagram illustrates the digital coupon management process. The process is specified in detail in the *Digital Coupon Management Standard Specification Document*.

Figure 2.6.2.2-1. Digital coupon management process

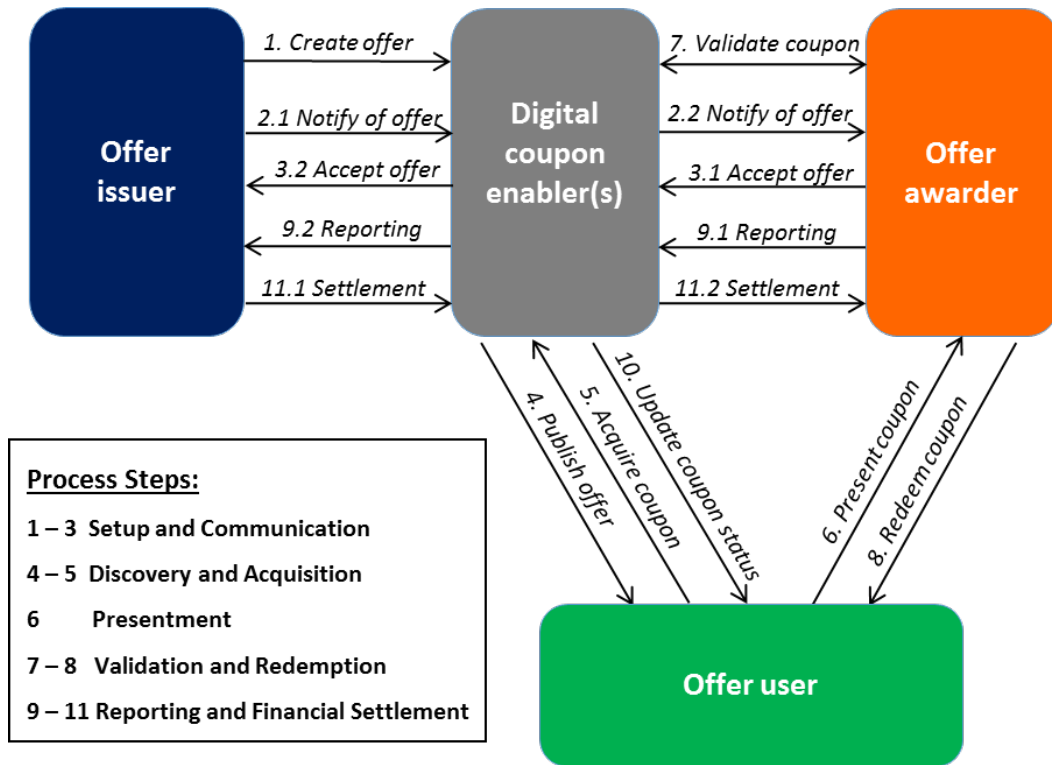

2.6.2.2.1 Relation with existing coupon specifications

The digital coupons specification will co-exist in the foreseeable future with coupon specifications described in section 2.6.3 that are restricted to national or common currency regional applications specified by the respective GS1 Member Organisations.

2.6.2.2.2 Identification requirements for digital coupons

The digital coupon management process specifies the following identification requirements:

- Parties, e.g., offer issuer, digital coupon enabler, retailer, SHALL be identified with a GLN.
- Digital coupons are always related to offers and promotions on products or services. Products as well as services SHALL be identified with a GTIN.
- Digital coupons may be managed in conjunction with loyalty cards. If appropriate, consumer loyalty cards accounts may be identified with a GSRN.

Digital coupons SHALL be identified by a Global Coupon Number assigned by the coupon issuer. The GCN comprises a GS1 Company Prefix followed by a coupon reference. It may be supplemented by an optional serial number.

GS1 key

Required

GCN

The GS1 Application Identifier to indicate the Global Coupon Number (GCN) is AI (255) (see section [3.2](#) for a list of all GS1 Application Identifiers).

Rules

All the GCN Application Rules described in section [4](#).

Attributes

Required

Not applicable

Optional

For all the GS1 Application Identifiers that may be used with an GCN, see section [3.2](#).

Data carrier specification

Carrier choices

Data carrier specifications for the GCN were out of scope and therefore not addressed when this standard was developed. Local implementations may choose to use the GS1 DataBar to carry the coupon identifier, as it is the only carrier that is capable of holding the identifier structure that is approved for POS use within the GS1 system.

Symbol placement

Not applicable

2.6.3 Coupons with restricted geographic distribution

2.6.3.1 General rule

GS1 system coupon identification specifications are flexible and have been designed to cater to current and future requirements.

Due to the nature of coupon numbering, a range of national solutions is offered, each of which is defined by the respective GS1 Member Organisation. National coupon solutions are not unique worldwide and must be operated in the restricted area defined by the GS1 Member Organisation.

In the interest of consistency and to avoid misinterpretation by equipment vendors, when defining national specifications, GS1 Member Organisations SHOULD include appropriate mention of all GS1 system coupon data structures.

Coupon reference numbers must not be reused for a period of three years.

2.6.3.2 Recommendation on allocating coupon reference numbers

The exact method used to allocate GS1 system coupon reference numbers is left to the discretion of the issuing organisation. However, the GS1 US Coupon Code must be unique for each individual promotion. For ease of administration, coupon reference numbers SHOULD be allocated sequentially.

2.6.3.3 Coupon identification for restricted geographic distribution (GS1 Prefix 99)

Application description

A coupon is a voucher with a cash value that is deducted at the point-of-sale. It is sometimes associated with a specific trade item. Coupon identification is organised on a national level and is therefore not unique worldwide. The specification of the coupon data structure in the element string is the responsibility of each GS1 Member Organisation. The internationally agreed standard for GS1 system coupon numbers is shown in the figure below.

Figure 2.6.3.3-1. Format of the element string

GS1 Prefix	Coupon data (structure determined by GS1 Member Organisation)	Check digit
9 9	N ₃ N ₄ N ₅ N ₆ N ₇ N ₈ N ₉ N ₁₀ N ₁₁ N ₁₂	N ₁₃

The GS1 Prefix 99 denotes the element string for GS1 coupon identification.

The structure of the coupon data field is determined according to the needs of a particular country. Mandatory components are the coupon issuer number and the coupon reference number. Other useful data are the redemption value in real or encoded format and codes for the decimal point or tax rates.

The check digit is explained in section 7.9. Its verification, carried out automatically by the barcode reader, ensures that the data corresponds with the verification rules.

The data transmitted from the barcode reader means that the data of a coupon has been captured. Processing of coupons at a point-of-sale usually consists of validity checks and deduction of its value.

Within this agreed standard for GS1 system coupon numbers, each GS1 Member Organisation is free to develop a national coupon solution. Four recommended structures provide a degree of equipment standardisation. These recommended structures are shown in the figure below.

Figure 2.6.3.3-2. Recommended coupon data structures

GS1 Prefix	Recommended coupon data structures (exact structure determined by GS1 Member Organisation)	Check digit
9 9	Y Y Y Y R R R V V V	C
9 9	Y Y Y R R R V V V V	C
9 9	Y Y Y Y Y R R R T T	C
9 9	Y Y Y Y Y R R R R R	C

- Where:
- Y** = Coupon issuer number (issued by the GS1 Member Organisation).
 - R** = Coupon reference number (allocated by a coupon issuer).
 - V** = Redemption value.
 - T** = Value code (standardised by the GS1 Member Organisation).
 - C** = Check digit calculated according to the standard algorithm.

The GS1 Member Organisations or retailers may require that the third digit of the coupon numbers (990 to 999) be programmable in order to cope with specific demands such as:

- Taxable or non-taxable coupons
- Different currencies
- Indication of the decimal position

GS1 key

Not applicable

Attributes

Not applicable

Data carrier specification

Carrier choices

EAN-13

Symbol X-dimension, minimum symbol height and minimum symbol quality

See section [5.12.3.1](#), *GS1 symbol specification table 1*.

Symbol placement

Not applicable

Unique application processing requirements

For a description of processing requirements, see section [7](#).

2.6.3.4 GS1 common currency coupon identification (GS1 Prefixes 981 to 983)

A coupon is a voucher with a cash value that is deducted at the point-of-sale. It is sometimes associated with a specific trade item. Coupon identification is normally organised on a national level using the GS1 Prefix 99. However, for a common currency area, coupon identification is organised between participating countries. Determining the coupon data structure in the element string is the responsibility of all the GS1 Member Organisations in the common currency area. The GS1 Prefixes 981 to 983 have been released for use with coupons expressing a value in a common currency.

The structure of the coupon data positions is determined according to the needs of a particular set of countries. Mandatory components are the coupon issuer number and the coupon reference number. Further useful data is the redemption value in real or encoded format and numbers for the decimal point or tax rates.

The check digit is explained in section [7.9](#). Its verification, carried out automatically by the barcode reader, ensures that the data corresponds with the verification rules. The internationally agreed standard for GS1 common currency coupon codes is shown in the figure below.

Figure 2.6.3.4-1. Format of the element string

GS1 Prefix	Coupon data (structure determined by GS1 MOs in common currency area)	Check digit
9 8 1		
-	N ₄ N ₅ N ₆ N ₇ N ₈ N ₉ N ₁₀ N ₁₁ N ₁₂	N ₁₃
9 8 3		

Within this structure, GS1 Member Organisations in a common currency area SHOULD develop a common coupon solution that is valid throughout the common currency area.

2.6.3.5 Use of GS1 common currency coupon code for the euro

Application description

At present the only application of GS1 Prefixes 981, 982 and 983 is for the euro. Within the euro area, coupon issuer numbers are administered by:

GS1 Global Office
 Avenue Louise 326
 1050 Brussels
 Belgium
 Tel: + 32.2.788.78.00

Contact: helpdesk@gs1.org

See the figure below for the coupon data structure in the euro area.

Figure 2.6.3.5-1. Format of the element string

GS1 Prefix	Coupon data			Check digit
9 8 1	Y ₁ Y ₂ Y ₃ Y ₄	R ₁ R ₂	E E , E	C
9 8 2	Y ₁ Y ₂ Y ₃ Y ₄	R ₁ R ₂	E , E E	C
9 8 3	Y ₁ Y ₂ Y ₃ Y ₄	R ₁ R ₂	E , E E	C

GS1 Prefix	Coupon data	Check digit
Y = Coupon issuer number (issued by a GS1 Member Organisation).		
R = Coupon reference number (allocated by a coupon issuer).		
E = Redemption value (expressed in euro); value 000 indicates free gift.		
C = Check digit calculated according to the standard algorithm.		

-  **Note:** The only difference between the two structures is the position of the implied decimal point.

GS1 key

Not applicable

Attributes

Not applicable

Data carrier specification

Carrier choices

EAN-13

Symbol X-dimension, minimum symbol height and minimum symbol quality

See section [5.12.3.1](#), *GS1 symbol specification table 1*.

Symbol placement

Not applicable

Unique application processing requirements

Processing of coupons at a point-of-sale usually consists of validity checks and deduction of its value.

2.6.3.6 Coupon code identification for use in North America AI (8110)

Application description

This GS1 Application Identifier (AI) replaced the U.P.C. Prefix 5 system in 2011. The AI (8110) system is in use for paper coupons only.

See GS1 US for the *North American Coupon Application Guideline using GS1 DataBar Expanded Symbols* for detailed information on GS1 US coupon code data content.

2.6.3.7 Positive offer file coupon code identification for use in North America AI (8112)

Application description

See GS1 US for the North American coupon application guideline for detailed information on GS1 US coupon code data content.

When a traditional AI (8110) paper coupon transaction occurs at point-of-sale, the data string elements are used to convey the purchase requirement and savings value so that the coupon can be processed accordingly. It is not possible to reliably validate a specific list of GTINs or systematically ensure serialised coupons are not used more than once across retailers. The use of AI (8112) prompts point-of-sale systems to make a call-out to an external positive offer file that maintains offer details that retailer point-of-sale systems use to validate the offer and expire it to prevent further use. AI (8112) can be used with paperless or paper offers if the offer details have properly been set up with the positive offer file.

2.6.4 Refund receipts

Application description

Refund receipts are vouchers produced to automate payment for returned empty containers. Refund receipts automate and expedite the handling of empty containers (e.g., bottles, crates) that have a refund value in a retail store.

When customers return empty containers (that have a refund value), the containers have to be checked and valued. This process can be done manually or by automated equipment capable of handling empty containers. When the returned containers have been valued, a refund receipt is printed and given to the customer. The customer presents the refund receipt at the store checkout, and the corresponding amount is refunded in cash or deducted from the customer's bill.

An EAN-13 barcode can be printed on the refund receipt to encode the required data including a security number and the monetary value.

The structure of refund receipts ensures uniqueness against all other GS1 system ID numbers only when used within the restricted environment defined by the appropriate GS1 Member Organisation.

The GS1 Prefix 980 has been released for use with refund receipt data. The internationally agreed standard for GS1 system refund receipt data is shown in the figure below.

Figure 2.6.4-1. Format of the element string

GS1 Prefix	Refund receipt data (structure determined by GS1 Member Organisation)	Check digit
9 8 0	N ₄ N ₅ N ₆ N ₇ N ₈ N ₉ N ₁₀ N ₁₁ N ₁₂	N ₁₃

Within this structure, each GS1 Member Organisation develops its own national refund receipt solution. The recommended structure shown in the figure below provides some degree of equipment standardisation.

Figure 2.6.4-2. Format of the element string

GS1 Prefix	Recommended structure	Check digit
9 8 0	S S S S S V V V V	C
<p>S = Security number. This number is used to provide some security in the handling of the refund receipt. For example, it consists of a sequential number, which is incremented by 1, for each ticket generated. In this case, the point-of-sale system will be able to recognise a refund receipt that had already been refunded. The security number can also include a two-digit machine number and a three-digit sequential number, in the case where several machines are available to the customers at the same location.</p> <p>V = Monetary value of the refund. The scale factor (decimal places) will depend on the currency used.</p> <p>C = Check digit. Calculated according to the standard algorithm</p>		

GS1 key

Required

Not applicable

Rules

Refund receipt specifications are flexible and have been designed to cater for current and future requirements.

Due to the nature of refund receipt identification, several national solutions are offered, each of which is defined by the respective GS1 Member Organisation. National refund receipt solutions are not unique worldwide and must be operated in the restricted circulation defined by the GS1 Member Organisation.

Data carrier specification

Carrier choices

EAN-13

Symbol X-dimension, minimum symbol height and minimum symbol quality

See section [5.12.3.1](#), *GS1 symbol specification table 1*.

Symbol placement

Not applicable

Unique application processing requirements

For a description of processing requirements, see section [7](#).

2.6.5 Electronic serial identifier for cellular mobile telephones (CMTI): AI (8002)

Application description

The purpose of an electronic serial identifier, AI (8002), for cellular mobile telephones (CMTI) is to uniquely identify a cellular phone within a given jurisdiction.

The information from the barcode can be used to automate and speed up the capture of CMTIs. CMTIs are usually assigned by a national or pluri-national authority. Issuing authorities must ensure that the electronic serial identifier is unique for each cellular phone. However, because electronic serial identifiers are assigned by different issuing authorities, they are not unique worldwide. An electronic serial identifier, AI (8002), is assigned by the appropriate national or pluri-national body and can be carried by a barcode placed directly on the cellular phone. The electronic serial identifier, AI (8002), is unique for each cellular telephone within the jurisdiction of the issuing body.

GS1 key

Not applicable

Attributes

Required

See section [3.2](#), Cellular mobile telephone identifier: AI (8002).

Optional

Not applicable

Rules

Not applicable

Data carrier specification

Carrier choices

GS1-128

Symbol X-dimension, minimum symbol height and minimum symbol quality

See section [5.12.3.4](#), *GS1 symbol specification table 4*.

Symbol placement

Not applicable

Unique application processing requirements

Not applicable

2.6.6 Payment slips

Application description

A payment slip is that part of a paper invoice used to facilitate payment. Payment slips cover a wide range of payment demands, such as telephone bills, electricity bills and insurance renewals. The payment slip is normally issued by a service provider (the invoicing party) to a final customer (the invoicee) and represents a payment demand. Normally the payment slip would outline in non-HRI text:

- Details of the customer
- Details of the service provider
- A detailed invoice for the service(s) provided
- A reference number
- The amount payable
- The payment conditions (e.g., pay before date, where to pay)

GS1 key

Not applicable

Attributes

Required

- **Global Location Number of the invoicing party** – The GS1 Application Identifier (AI) to indicate the Global Location Number (GLN) of the invoicing party is AI (415), see section [3.2](#). The GLN of the invoicing party identifies the issuer of the payment slip. It is used as a key to access database information about the invoicing party (normally held by the payment receiving agency). The same GLN is used for all payment slips issued by the invoicing party under identical payment conditions. The GLN of the invoicing party is used by the payment receiving agency to reference the characteristics of the contract with the invoicing party, such as:
 - Whether the payment can be accepted.
 - Contact details of the invoicing party.
 - Action to take if the due date has expired.
 - Transfer arrangement of funds to the invoicing party's bank.

A different GLN SHALL be used whenever the payment conditions are different. For more information, see section [4](#).

- **International Bank Account Number (IBAN): AI (8007)** – The GS1 Application Identifier to indicate the International Bank Account Number (IBAN) is AI (8007), see section [3.2](#). The bank account identifier of the invoicing party is defined in *ISO 13616*. It is used to identify where to send the payment and, in the receiving country, which bank holds the account for international bank payment.
- **Payment slip reference number: AI (8020)** – The GS1 Application Identifier to indicate a payment slip reference number is AI (8020), see section [3.2](#).

By their nature, payment slips need to be individually tailored for the invoicee and, therefore, require a unique reference number, the payment slip reference number, AI (8020). Reminder notices SHOULD use the same number as the original notice. The payment slip reference number, AI (8020), is issued by the invoicing party and is a unique number in the system. Payment slip reference numbers, AI (8020), SHOULD be sequentially allocated.

The payment slip reference number, AI (8020), uniquely identifies the payment slip when used in conjunction with the Global Location Number (GLN) of the invoicing party. It is used to communicate details of payment among all the partners involved: invoicing party, invoicee, payment receiving agency and banks. It is also used to access locally held information.

- **Amount payable** – There are two GS1 Application Identifiers to indicate the amount payable:
 - AI (390n) = amount payable for a single monetary area, see section [3.2](#).
 - AI (391n) = amount payable with ISO three-digit currency code, see section [3.2](#).

(n = indicates the implied decimal point position)

If the amount payable is expressed in a barcode, AI (391n) should be used, as this ensures the currency of the payment can be automatically processed and verified by the system. However, if the currency is unambiguously implied by the system, AI (390n) may be used. To avoid ambiguity, only one AI encoding the amount payable SHALL be used, and the currency must be clearly indicated in human readable form.

Scanning systems should have the facility to override the amount payable. This functionality is required should the invoicee wish to make the minimum required payment, which could be less than the total amount due. The amount due is attribute information and, when used, must be processed with the Global Location Number (GLN) of the invoicing party.

- **Due date for amount on payment slip** – The GS1 Application Identifier to indicate the due date is AI (12), see section [3.2](#).

The due date indicates the date by which the invoice should be paid (by the invoicee). It is attribute information and, when used, must be processed with the Global Location Number (GLN) of the invoicing party.

-  **Note:** The due date must be represented in the YYMMDD format in the barcode; however, the human readable interpretation can be presented in whatever form is appropriate.

Optional

Not applicable

Rules

See section [4.13.2](#), *Mandatory association of element strings*.

Data carrier specification

Carrier choices

GS1-128

Symbol X-dimension, minimum symbol height and minimum symbol quality

See section [5.12.3.4](#), *GS1 symbol specification table 4*.

Symbol placement

No standard placement. The figure below is an example.

Figure 2.6.6-1. Example of numbering and symbol marking for payment slips

<p>ABC-Electric Company</p> <p>Mr A.N. Customer 45 Sunrise Drive Cape Town, TX 765444</p> <p>Electricity consumption period: 1 January 2001 to 31 March 2001</p> <p>Amount Payable 12.50 South African Rand</p> <p>DUE DATE 25 April 2001 PAY TO: 5412345678908 REF NO.: ABC123</p>		 <p>(415) 5412345678908 (3911) 710125</p>
	 <p>(12) 010425 (8020) ABC 123</p>	



Note:

- **(415) 5412345678908** – AI (415) indicates the Global Location Number (GLN) of the invoicing party. The GLN is a fixed length 13-digit number terminated by a standard check digit. The rules for allocating GLNs ensure that this number is unique worldwide. GLNs are used by the payment receiving agent to distinguish between payment slips that can and cannot be accepted.
- **(12) 010425** – AI (12) indicates the due date by which the payment should be made. The due date is always encoded YYMMDD; however, other formats may be used for the human readable interpretation equivalent. The use of the due date is optional, but if used, the payment receiving agent and the invoicing party SHOULD agree about what action will be taken if the due date has expired.
- **(3911) 710125** – AI (3911) indicates the amount payable with ISO currency number. From *ISO 4217*, "710" indicates South African Rand. It is strongly recommended to use the ISO currency number when encoding this optional data element. The fourth digit of this AI is the decimal point indicator. For example, the digit 1 in this position would indicate one digit after the decimal point; a 2 would indicate two digits after the decimal point.
- **(8020) ABC123** – AI (8020) indicates the payment slip reference number. The payment slip reference number, AI (8020), is a mandatory data element for this application. It is processed with the GLN of the invoicing party and provides a unique reference for all communications between the payment agent and the invoicing party.

Unique application processing requirements

Not applicable

2.6.7 Customer specific articles

2.6.7.1 Introduction

The GS1 system guidelines for trade items (see section [2.1](#)) state that each item of trade is assigned a non-significant number that uniquely identifies the item in an unrestricted environment. The same number is used to identify a series of identical items, with every variant being allocated a separate unique identification number whenever the variation is apparent and significant between partners in the supply chain or to the final user.

This system enables the use of Automatic Data Capture (ADC) and Electronic Data Interchange (EDI) in an open environment, globally. However, in several business sectors, because of the vast number of possible manifestations of certain made-to-order articles, pre-allocation of Global Trade Item Numbers (GTINs) at the lowest level is not feasible.

For organisations that trade in such made-to-order products, GS1 in association with trade representatives has developed the following guidelines. They have been designed to improve supply chain efficiency by enabling ADC and efficient ordering via EDI.

These guidelines are fully compatible with, and should be treated as a special case of, the GS1 system recommendations for the numbering and symbol marking of trade items.

2.6.7.2 Application overview

2.6.7.2.1 Definition

A customer specific article (CSA) is broadly defined as any item where the supplier defines all possible manifestations of the article from which the customer may choose, and pre-allocation of article numbers at the lowest level is not feasible. CSAs are never made for stock, and hence are always made to order. However, made-to-order articles are not necessarily customer specific, but could be standard.

A typical example of a CSA is a chair that is available in 300 different types of upholstery for the seat, back and armrest. This list of available upholstery could also be used for other types of furniture the supplier offers. There are 27,000,000 ordering possibilities for this chair (300 x 300 x 300). Typically, the supplier's catalogue lists a generic style of chair as well as the 300 different upholstery options. The customer chooses the style of chair and selects upholstery for the seat, back and armrest.

On receipt of order, the supplier produces the customer specific chair and makes it available to the customer. Because the supplier defines the customer's options, and because the customer must specify his or her choices based on those options, the order contains all the information the supplier requires to manufacture the chair. This example highlights four separate process steps:

- The supplier makes available all the possible manifestations of an article.
- The customer specifies the actual article required using the supplier catalogue.
- The supplier manufactures the article in accordance with the customer's specifications.
- The CSA is delivered.

The GS1 system has formalised this process, enabling efficient Automatic Data Capture (ADC) and Electronic Data Interchange (EDI) throughout the supply chain. The CSA data model is based on the assumption that the supplier defines the possible components (either in a paper or electronic catalogue) and the customer specifies the actual article required.

The processes for identifying and ordering the article are dealt with separately. Although these processes are closely related, each requires separate consideration in an open system.

2.6.7.2.2 Customer specific articles data flow

The data flow model is organised on a series of assumptions designed to ensure that the model is independent of the type of article and the sector: It is a generic model. Because many different procedures may be applied by various manufacturers, the generic model is meant to be a general guide. By using this model, companies can communicate in a standard way and (re)organise the automated handling of customer specific article (CSA) specification according to this guideline.

The model assumes that the supplier informs the customer of all available ordering options and specifications. This is achieved by means of an electronic catalogue (see the figure below). From this catalogue the customer can determine which article(s) to order. In the order message the base article number and the chosen specifications are communicated.

Figure 2.6.7.2.2-1. Customer Specific Articles - data flow

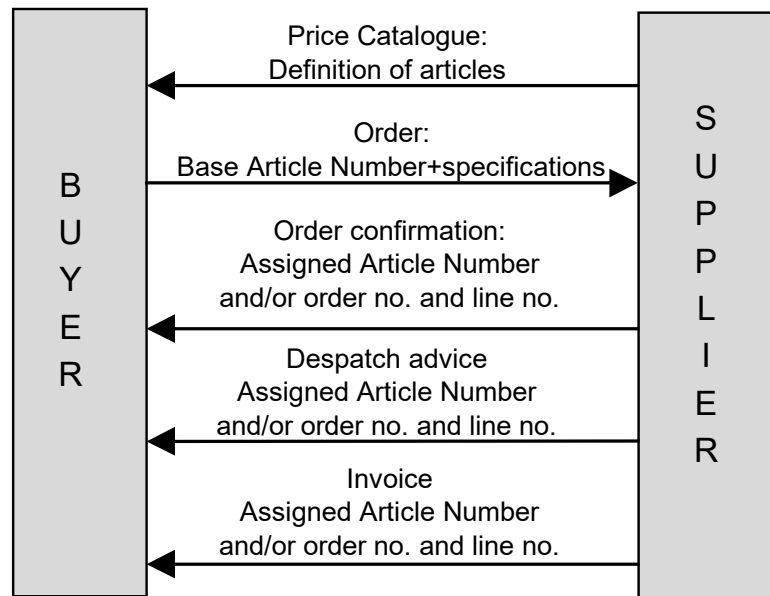

In the order confirmation, the supplier may confirm that the article ordered can be manufactured (that is, that the buyer has made a correct combination of specifications). This should be the case assuming the customer has up-to-date database information. The order confirmation may also be used to notify the customer of the assigned article number. The assigned article number may be used in all subsequent communications. For example, the despatch advice and invoice messages use the assigned article number and, if required, the order number plus the order line number to establish an unambiguous link with the CSA.

The article produced may not be numbered with a string of numbers representing the base article number plus the applicable specifications (see section [2.6.7.3.8](#)).

2.6.7.3 Allocating system numbers for customer specific articles

2.6.7.3.1 General rule

Each different product must be identified by a unique number. This implies that each variant of a product is assigned a different number. For example, each different size or colour of a garment has its own individual identification number. Article numbers SHOULD be sequentially allocated for this purpose.

2.6.7.3.2 Ordering of customer specific articles

The ordering process of customer specific articles (CSAs), the customer specification process, is based on a supplier's catalogue definitions. Internal identification systems are often manual and become increasingly complex and prone to error as the number of trading partners increases. In addition, the use of internal codes can be cumbersome, inflexible and prone to duplication among different suppliers. These recommendations, which are based on the open systems principle, seek to avoid internally-based systems. Catalogue products using GS1 system identification numbers are guaranteed to be uniquely identifiable worldwide.

A customer specific articles EANCOM user profile for the price catalogue (PRICAT), orders (ORDERS) and the response to order (ORDRSP) messages have been published that use the numbering system outlined in the following subsections.

2.6.7.3.3 Base article number

A supplier assigned base article number is given to each generic product type for ordering purposes. A GTIN-12 or GTIN-13 is used for this functionality. The GTIN is defined by the supplier and must be unique with respect to all other GS1 system identification numbers. Because it does not identify an

item, the base article number will never be carried by a barcode on an article. It is solely used for ordering purposes.

The base article number indicates to the customer that a number of supplier defined questions have to be answered by the customer. These specifications (questions and associated answers), which are relevant to a base article number, are communicated via an electronic catalogue. The specifications available for each different article are defined by the supplier.

2.6.7.3.4 Specifications

Specifications are linked to the different base article numbers for the purposes of ordering. The same specifications may be used with different base article numbers. Specifications fall into one of the categories described in the following subsections.

2.6.7.3.5 Option

An option is a specification with a discrete value that is predefined by the supplier and associated with a base article number. Each option may be identified with a GTIN-12 or GTIN-13. The GTIN is defined by the supplier and must be unique with respect to all other GS1 system identification numbers. An ID number of an option will never be carried by a barcode on an article. It solely is used for communication purposes. Options, such as red leather seat covers may be valid for different base articles.

2.6.7.3.6 Parameter

A parameter is a specification within a range of values (e.g., dimensions) ranging from a minimum to a maximum and including a step size.

Each parameter may be identified with a GTIN-12 or GTIN-13. The GTIN is defined by the supplier and must be unique with respect to all other GS1 system identification numbers. The parameter identification will never be carried by a barcode on an article. It is solely used for ordering purposes. Parameters SHOULD be communicated using the standard EANCOM syntax and SHOULD be related to a base article number.

2.6.7.3.7 Part

A part is a physical article that may also be ordered separately. Parts are identified within Global Trade Item Numbers (GTINs). The GTIN-12 or GTIN-13 for the part may be used in association with a base article number to create a composite, an article made up of one or more individual parts. A part may be associated with a number of different base articles.

2.6.7.3.8 External references

An external reference is often required for a customer-designed or custom-made item. External references are specified through a separate, non-EDI communication channel, such as a fax or CAD/CAM drawing. A secondary source can be used to communicate a set of customer-defined specifications (not predefined by the supplier).

2.6.7.3.9 Data carrier

GS1 system identification numbers used to identify customer specific articles (CSAs) for ordering purposes may never be carried by a barcode on the physical article. However, suppliers may wish to utilise barcode scanning as part of the order process. This may be achieved by representing base articles and identification numbers in machine readable form in a paper catalogue. GS1-128 barcodes, utilising an GS1 Application Identifier for internal applications, SHOULD be used for this purpose.

2.6.7.4 Identification of the physical article actually produced

Application description

In environments with automated systems the physical article needs to be identified and the identification of the produced article is required in machine readable form (as a barcode). The identification of the physical article must be communicated from the supplier to the customer. Both supplier and customer should be able to use the same identification number and each need to keep a record of this number.

For open systems, the most appropriate identification number is the GTIN-12 or GTIN-13. Identifying a physical article with a GTIN and a barcode allows customer specific articles (CSAs) to be integrated within a system that manages all other items identified using the GS1 system. During order confirmation, the supplier assigns the GTIN-12 or GTIN-13 to the product. It is not necessary to pre-assign numbers to all possible articles, only to those that are actually produced.

Each different product must be identified by a unique number. This implies that each variant of a product is assigned a different number. For example, each different size or colour of a garment has its own individual identification number. Article numbers SHOULD be sequentially allocated for this purpose.

GS1 key

Required

GTIN

Rules

All the GTIN rules in section [4.2](#).

Attributes

Not applicable

Data carrier specification

Carrier choices

The barcode requirements for customer specific articles (CSAs) are the same as those for trade items. The data carrier used to carry the GS1 system identification number of a physical article SHALL be one of the following:

- EAN-13 or UPC-A
- ITF-14
- GS1-128 (attribute information always uses GS1-128 barcodes)

With CSAs, the choice of data carrier is left to the discretion of the organisation responsible for issuing the GS1 system identification number. Trade items that will be scanned at a point-of-sale always SHOULD be marked using the EAN/UPC symbology.

Symbol X-dimension, minimum symbol height and minimum symbol quality

See section [5.12.3.1](#), *GS1 symbol specification table 1*.

Symbol placement

Not applicable

Unique application processing requirements

For a description of processing requirements, see section [7](#).

2.6.8 Custom trade item

2.6.8.1 Allocating system numbers for custom trade items

2.6.8.1.1 General rule

Customer specific items, as described in the previous section, (section [2.6.7](#)) are configured from a wide variety of known parameters. Things like colour, size, model and various materials are listed and uniquely identified. A customer specific item is created when a selection is made from each category, sufficient to create the item. Customer specific items may be intended for the end consumer (e.g., furniture) and can be marked with a GTIN and data carrier appropriate for point-of-sale (POS).

Custom made-to-order trade items are different from customer specific items in that they are one-of-a-kind, made-to-order items that are strictly sold from business to business. Their use is approved for the manufacturing and maintenance, repair & overhaul (MRO) environment. Examples include custom abrasive belts, special adhesives and made-to-order cutting tools needed for a specific machine and cutting application. Their specifications may be called out in a series of blue prints or other technical documents.

Each different product must be identified by a unique number. If a trade item is a stock trade item, it is assigned the appropriate fixed measure GTIN. If any trade item, custom or not, will be scanned at POS, then it must be assigned a GTIN-12, GTIN-8, or GTIN-13 and represented in a barcode symbology approved for POS. At the discretion of the supplier, it is always acceptable to use a GTIN-12, GTIN-8 or GTIN-13 to identify a trade item, whether custom or not. In other words, a supplier or manufacturer is not required to use the method described below to identify a custom item. They may give each and every different trade item a unique GTIN. However, this will deplete their pool of possible GTIN more quickly.

This method of assigning unique product identification uses a base GTIN-14, indicator digit 9 which signifies a GTIN with a variable component (i.e. it is a custom, made-to-order item), followed by a Made-to-Order variation number. The Made-to-Order variation number is a variable length, numeric field up to six digits. This allows each base GTIN-14, indicator digit 9 to be used for 1,000,000 different custom variations. Multiple items, made to the same specifications could have the same combination of the base GTIN-14, indicator digit 9 and Made-to-Order variation number.

2.6.8.1.2 Ordering of custom trade items

A supplier or manufacturer may indicate in their paper or electronic catalogue that certain items can be ordered based on customer specifications. A GTIN-14, indicator digit 9 can be assigned to denote that it is possible to order a customised version of this trade item. However, in this case, no physical item exists. When the order is accepted for the made-to-order custom item, a Made-to-Order Variation number is assigned to this specific version. Multiples of this same item may be ordered at one time. It is the combination of the GTIN-14, indicator digit 9 and the Made-to-Order variation number that uniquely identifies the custom items.

2.6.8.1.3 Custom trade item number

A GTIN-14, indicator digit 9 indicates a variable measure trade item. Additional information is needed to complete the identification of the trade item. A custom trade item number is the combination of a GTIN-14, indicator digit 9 and the Made-to-Order variation number. This combination is used in electronic business transactions and in barcode representation. When many items with the exact same specifications are manufactured at one time, they will each carry the same combination of GTIN-14, indicator digit 9 and Made-to-Order variation number.

2.6.8.1.4 Base GTIN-14

To indicate that a trade item is available in a custom format, a base GTIN-14, indicator digit 9, is used. A base GTIN-14, indicator digit 9 may appear in the supplier's paper or electronic product catalogue to indicate the possibility of a custom item. This GTIN does not identify a specific trade item, but a general category of possible custom trade items. The description indicates that this is a custom, made-to-order item. A manufacturer may create one GTIN-14, indicator digit 9 to represent

any and all made-to-order trade items, or they may assign one for each category of custom items (custom abrasive belts, custom abrasive pads, etc.). Further a manufacturer may choose to create a GTIN-14 indicator digit 9 for sub-categories (custom abrasive belts, 1 to 2 Inches Wide; custom abrasive belts, 2 to 3 inches wide and so on).

2.6.8.1.5 Made-to-Order variation number

Once the specifications for a custom trade item are agreed upon between the customer and the manufacturer, the manufacturer will assign a Made-to-Order variation number to that custom item. A Made-to-Order variation number is always used with a GTIN-14, indicator digit 9.

The Made-to-Order variation number is communicated from the manufacturer to the customer during the Request for Quote/Response to Request for Quote process or on a Purchase Order Acknowledgement or by some other mutually agreed upon method. In a barcode representation, GS1 Application Identifier AI (242) is used to denote a Made-to-Order variation number. The Made-to-Order variation number is numeric and variable length up to, and including, six digits.

A Made-to-Order variation number will never appear alone, but must always be associated with the appropriate GTIN-14, indicator digit 9. Further, a Made-to-Order variation number may not be used with GTIN-8, GTIN-12, GTIN-13 and GTIN-14 indicator digit 1 through 8.

The use of a GTIN-14, indicator digit 9 and a Made-to-Order variation number is only approved for the manufacturing and maintenance, repair & overhaul (MRO) environment.

2.6.8.1.6 Data carrier

GS1 system identification numbers used to identify custom made-to-order items in the manufacturing, pick, pack, shipping, receiving and inventory management process may be carried by a barcode on the physical article. This may be achieved by representing identification numbers in machine readable form. GS1 barcodes, utilising GS1 Application Identifiers, should be used for this purpose.

2.6.8.2 Identification of the physical article actually produced

Application description

In environments with automated systems the physical article needs to be identified and the identification of the produced article is required in machine readable form (e.g., as a barcode). The identification of the physical article must be communicated from the supplier to the customer. Both supplier and customer should be able to use the same identification number and each need to keep a record of this number.

For open systems, the appropriate identification number for a custom trade item is the base GTIN-14 indicator digit 9, followed by a Made-to-Order variation number. During order confirmation, the supplier assigns the Made-to-Order variation number to this version of the product.

Products made to the same specifications can carry the same combination GTIN-14, indicator digit 9 and Made-to-Order variation number.

GS1 key

Required

GTIN

Rules

The base GTIN-14, indicator digit 9 in combination with the Made-to-Order variation number comprises the key for a custom trade item. The base GTIN-14 is comprised of indicator digit 9, GS1 Company Prefix followed by an item reference and a check digit. The Made-to-Order Variation number is variable length, numeric, up to and including six digits.

Attributes

AI (01) is used for the GTIN-14, indicator digit 9, plus AI (242) for the Made-to-Order variation number when the item is considered a trade item. The combination of AI (02) plus AI (242) and AI (37) Count of trade items contained in a logistic unit, is used in conjunction with an (00) Serial Shipping Container Code when marking a logistics unit of custom trade items.

Data carrier specification

Carrier choices

- GS1-128
- GS1 DataBar
- GS1 DataMatrix
- GS1 QR Code

Symbol X-dimension, minimum symbol height and minimum symbol quality

See section [5.12.3.4](#), *GS1 symbol specification table 4*.

Symbol placement

Not applicable

2.6.9 Global Document Type Identifier for document control

Introduction

The Global Document Type Identifier is the GS1 identification key used to identify documents, electronic messages and digital files for the purposes of document control. Any aspect of referenced modification, version control, specific instance recording would fall into the process of document control, either internal or externally with trade partners, where unique identification is required.

The term “document” is applied broadly to cover any paper(s) or digital file(s). The Global Document Type Identifier (GDTI) can be used to identify any type of document including but not limited to:

- Commercial documents (e.g., invoice, purchase order)
- Documents that infer a right (e.g., proof of ownership)
- Documents that infer an obligation (e.g., notification or call for military service)
- Identification documents (e.g., driver’s licence, passport)
- Digital files
- Electronic messages

Application description

Physical documents and electronic messages used in communications with other parties often include a unique number that can be used as a reference. Also, digital files shared with other parties may require a unique identifier to ensure the use of the right type and version. The issuer of the document is normally responsible for the identification of the document.

The GDTI enables issuers to assign globally unique identifiers to documents and, where applicable, to physically mark these on the physical version(s) in barcode or EPC/RFID format.

Examples of documents that can be identified with the GDTI include, but are not limited to:

- Land registration papers
- Tax demands
- Proof of shipment/receipt forms
- Custom’s clearance forms
- Insurance policies

- Internal invoices
- National press documents
- Educational papers
- Transporting company documents
- Mail company documents
- Images

GS1 key

Required

GDTI

The GS1 Application Identifier to indicate the Global Document Type Identifier (GDTI) is AI (253), see section [3.2](#).

Rules

See section [4.7](#), *GDTI rules*.

Attributes

Required

Not applicable

Optional

For all the GS1 Application Identifiers that may be used with an GDTI, see section [3.2](#)

Data carrier specification

Carrier choices

- GS1-128
- GS1 DataMatrix
- GS1 QR Code

Symbol X-dimension, minimum symbol height and minimum symbol quality

See section [5.12.3.9](#), *GS1 symbol specification table 9*.

Symbol placement

No standard placement. The following are examples of numbering and symbol marking for document control:

Unique application processing requirements

For description of processing requirements, see section [7](#).

Example 1: Legally required declaration prior to travel

This example shows how GS1-128 barcodes can be used to automate the capture of information for traveller who enters or leaves the country.

Figure 2.6.9-1. Legally required travel declaration



Declaration of Luggage and Money of Travellers



 (253)950110153005812345678901

Name:			
Address:			
Date of Entrance:			
Items to Declare:			
Amount	Description	Value	Customs Value
I have read the instructions and declare the truth:			
Date and Signature:			
Document serial number: 12345678901			

Example 2: Insurance policy

This example shows how GS1-128 barcodes can be used to automate the capture of information on insurance policies. This standard solution provides benefit for the insurer, the insured and any potential beneficiaries as well as facilitates the automation of any monitoring and inspection of the requirement to fulfil the legal norms.

Figure 2.6.9-2. Insurance policy

<p>Policy Number: 67890543210987</p>	<p>Insurance Company</p>
Branch: Bogotá	Date of Policy: March 23, 2014
Name: Name of Insured	
Age: 34	Valid From: March 23, 2014
	Valid To: March 22, 2017
Contract Cover: Life	Value: 10,000
Date and Signature:	



(253)950110153006567890543210987

Example 3: Application form

This example shows how GS1-128 barcodes can be used to automate the capture of information on application forms. Many organisations require their clients to complete an application form.

Figure 2.6.9-3. Membership application form

Membership Application Form 7654321	
Name	
Address	
Postal code	
City	
Country	
Telephone number	
Email address	
Signature	Date and place



(253)95011015300657654321

Example 4: Freight-forwarding authorisation

This example shows how GS1-128 barcodes can be used to automate the capture of information on freight-forwarding forms. Many organisations require documentary evidence that goods have been dispatched prior to making payment.

Figure 2.6.9-4. Freight-forwarding authorisation

Suppliers or Forwarders Principals		 FIATA FCT Forwarders Certificate of Transport ORIGINAL		No. 123456 Forw. Ref.
Consigned to order of		 (253)9501101530065123456		
Notify address				
Conveyance	from/via			
Destination				
Marks and numbers	Number and kind of packages	Description of goods	Gross weight	Measurement

specimen

according to the declaration of the consignor

The goods and instructions are accepted and dealt with subject to the General Conditions printed overleaf.

Acceptance of this document or the invocation of rights arising therefrom acknowledges the validity of the following conditions, regulations and exceptions also of the trading conditions printed overleaf, except where the latter conflict with conditions 1-6 below.

- The undersigned are authorized to enter into contracts with carriers and others involved in the execution of the transport subject to the latter's usual terms and conditions.
- The undersigned do not act as Carriers but as Forwarders. In consequence they are only responsible for the careful selection of third parties, instructed by them, subject to the conditions of Clause 3 hereunder.
- The undersigned are responsible for delivery of the goods to the holder of this document through the intermediary of a delivery agent of their choice. They are not responsible for acts or omissions of Carriers involved in the execution of the transport or of other third parties. The undersigned Forwarders will, on request, assign their rights and claims against Carriers and other parties.
- Insurance of the goods will only be effected upon express instructions in writing.
- Unforeseen and/or unforeseeable circumstances entitle the undersigned to arrange for deviation from the envisaged route and/or method of transport.
- Unforeseen and/or unforeseeable disbursements and charges are for the account of the goods.

Insurance through the intermediary or the undersigned Forwarders

Not covered

Covered according to the attached Insurance Policy / Certificate

All disputes shall be governed by the law and within the exclusive jurisdiction of the courts at the place of issue.

For delivery of the goods please apply to:

Freight and charges prepaid to:

thence for account of goods, lost or not lost.

We, the Undersigned Forwarders in accordance with the instructions of our Principals, have taken charge of the abovementioned goods in good external condition at:

for despatch and delivery as stated above or order against surrender of this document properly endorsed.

In witness thereof the Undersigned Forwarders have signed originals of this FCT document, all of this tenor and date. When one of these has been accomplished, the other(s) will lose their validity.

Place and date of issue

Stamp and signature

Text authorized by FIATA. COPYRIGHT FIATA / Zurich - Switzerland 5.96

2.6.10 Internal applications

The GS1 system provides ten GS1 Application Identifiers for internal applications.

Data carrier specification

GS1 data carriers that can be used to represent GS1 Application Identifiers for internal applications are:

- GS1 DataBar Expanded Versions
- GS1-128
- GS1 DataMatrix
- GS1 QR Code
- EPC/RFID

Data carrier specifications (e.g., size, quality, placement) are to be determined internally, however GS1-128 symbols SHALL NOT be used for symbols that require more than 48 data characters and GS1 DataBar Expanded Versions SHALL NOT be used when symbols require more than 74 numeric or 41 alphabetic characters of data.

Though the definition of AIs (91) to (99) in the GS1 Tag Data Standard (TDS) allows for larger fields, to ensure compatibility with the General Specification, AI (91) to (99) character values encoded in the User Memory of an EPC/RFID tag SHOULD NOT exceed 90 characters in length.

2.6.10.1 Information mutually agreed between trading partners: AI (90)

Element string AI (90) may be used to represent any information that has been mutually agreed between two trading partners. The agreement may include the use of FACT DIs (Data Identifiers). If a FACT DI is used, it SHOULD appear immediately after the AI (90), followed by the appropriate data. The use of FACT DIs gives little security to users.

The data carrier containing this element string SHOULD be removed from any item that leaves the jurisdiction of the trading partners. Failure to remove the symbol may cause problems if another trading partner using the same AI for a separate internal application scans the item.

2.6.10.2 Company internal information: AIs (91) to (99)

Element strings AI (91) to (99) may contain any internal information relevant to a company's internal applications.

The data carrier containing these element strings SHOULD be removed from any item that leaves the jurisdiction of the company. Failure to remove the symbol may cause problems if a trading partner using the same AI for a separate internal application scans the item.

2.6.11 Consumer trade item production control

This application standard utilises GTIN and a GTIN attribute which are used by consumer trade item manufacturers to ensure the proper association of packaging components during production of a finished consumer trade item. The attribute is called a Packaging Component Number (PCN). The PCN identifies a packaging component which is used by only one manufacturer and is an attribute of the GTIN of the finished consumer trade item. For example, a bottle of cough syrup has a front and back label. It is critical the declarations on the labels match the product filled in the bottle. By using a different PCN on each label during packaging for a specific trade item identified with a GTIN, the manufacturer can ensure the right labels are used to produce the product (GTIN to PCN associations). PCN may be encoded as a standalone symbol or the PCN and GTIN may be encoded together. Package components shared between two or more manufacturers are not covered by this standard. Manufacturers and their packaging component suppliers will have to manage this situation. The PCN is assigned by the manufacturer (possibly under the direction of the brand owner).

GS1 key

Required

The following key formats are allowed in this application:

- GTIN-8
- GTIN-12
- GTIN-13
- For regulated healthcare non-retail applications: GTIN-14

Rules

GTIN of the finished consumer trade item SHALL NOT be used to identify packaging components (e.g., bottle, bottle cap, front label, back label) for the purpose of trade item production control; however GTIN is specified as the GS1 key for consumer trade item production control as the GTIN determines which packaging components are used in production.

Attributes

Required

The GS1 Application Identifier to indicate the Packaging Component Number is AI (243), see section [3.2](#).

Rules

PCN SHALL NOT replace GTIN for pricing, ordering, or invoicing upstream packaging components from the manufacturer's upstream suppliers. Per section [4.13](#), PCN has a mandatory association with one or more finished consumer trade item GTIN(s). The PCN and GTIN may or may not be encoded in the same symbol.

PCN is used only on packaging components used by one manufacturer. There may be more than one PCN associated with one GTIN. One PCN may be associated with multiple GTINs

There SHALL only be one PCN per each packaging component for the lifespan of the packaging component and one packaging component may change while another does not. For example a front and back label would each have a unique PCN and the front label may change while the back label does not.

Over a GTIN's lifespan, there may be more than one PCN per packaging component (e.g., front label).

Optional

Not applicable

Data carrier specification

Carrier choices

Figure 2.6.11-1. Carrier choices

Symbol options by consumer trade item type	Type of consumer trade item		
	General retail POS	Regulated healthcare POS (retail)	Regulated healthcare POC (non-retail)
GTIN and PCN in one symbol	GS1 DataBar	GS1 DataBar or GS1 DataMatrix	GS1 DataBar, GS1 DataMatrix, GS1-128, Composite Component
PCN standalone	GS1 symbol selection/size specifications left to the manufacturer's discretion		
GTIN, PCN, & Extended Packaging URL in one symbol	(*) GS1 DataMatrix or GS1 QR Code	GS1 DataMatrix	GS1 DataMatrix
(*) For general retail consumer trade items where PCN is combined with AI (8200) GS1 DataMatrix or GS1 QR Code may be used according to the specifications in figure 5.12.3.1-2 <i>GS1 symbol specification table 1 Addendum</i> .			

Symbol X-dimensions, minimum symbol height and minimum symbol quality

To determine the appropriate specifications for printing and quality control, see the GS1 symbol specification table(s) referred to in each Application Standard.

Symbol placement

When the PCN is encoded together with GTIN, symbol placement rules for consumer trade item apply. If the production line scanning of the PCN prohibits use of this symbol placement, the PCN must be encoded in a separate barcode.

Unique application processing requirements

For a description of processing requirements, see section [7](#).

2.6.12 Component/part identification

2.6.12.1 Application description

This application is subject to the following restrictions:

- The Component & Part Identifier is available for business processes where products are identified by the buyer. The buyer instructs his suppliers on how to identify and mark the products delivered to him.
- The identifier SHALL NOT be used in open supply chains. It is restricted to use by mutual agreement. The GTIN is the only GS1 standard identifier for trade items in open supply chains.

A Component/Part (C/P) is defined as an item that is intended to undergo at least one further transformation process to create finished goods for the purpose of downstream consumption. C/P examples may include:

- Drive motor for washing machine
- Fan assembly for a jet engine
- Pipe/tube
- Printed circuit board for television
- Starter motor for vehicle
- Magnetic coil for a Magnetic Resonance Imaging (MRI) machine
- Wheel axle

Several industry sectors use established systems for the identification of C/P in the supply chain. Very often, companies use alphanumeric identifiers for their C/P, which may be serialised. Many IT systems rely on the identifiers structure that includes limited meaningful information. Time-critical processes (material resource planning, delivery schedules, etc.) do not allow for a mapping of the identification schemes to other identifiers. In addition, there is often no ubiquitous network access available. Network failures can happen in reality and could lead to production interruptions which in turn lead to tremendous economic losses. For that reason, technical industries have implemented autonomous assembly lines, which are controlled by dedicated control terminals that need no permanent network access.

This application specifies a C/P Identifier that is available for the following processes:

- The C/P Identifier may be used by an OEM for their C/P procurement. The typical scenario is that an Original Equipment Manufacturer (OEM) assigns identifiers to Components/Parts necessary to build finished goods, such as automobiles. The C/P production is contracted to suppliers who use the C/P Identifier assigned by their customer, the OEM.
- The OEM and/or agents make use of the C/P Identifier in their production process.
- C/P Identifiers are also available to points of service for after sales services and maintenance activities, including procurement.

Note: GTIN remains the mandatory solution for items crossing aftermarket retail points of sale.

The following diagram illustrates the three main business processes where C/P Identifiers may be appropriate:

Figure 2.6.12.1-1. Business processes where C/P Identifiers may be appropriate

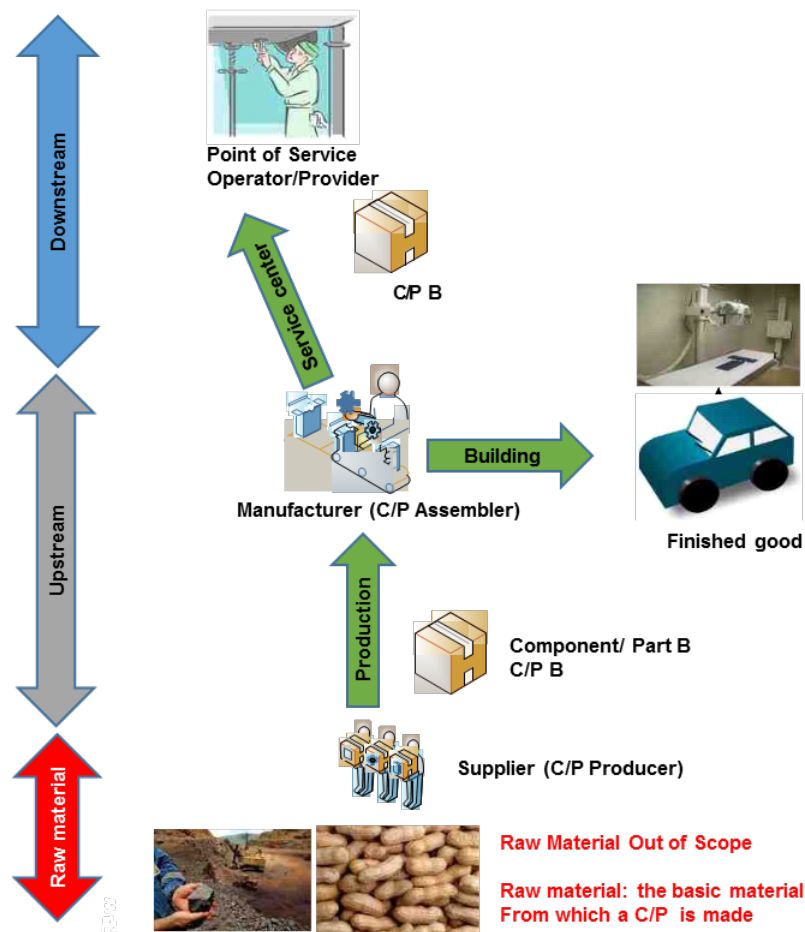

2.6.12.2 Identification requirements

Components/Parts that meet the requirements described above can be identified by a C/P Identifier that has the following characteristics:

- The C/P Identifier comprises a GS1 Company Prefix and C/P reference assigned by the GS1 Company Prefix holder.
- The C/P reference format is variable length. The Component/Part reference SHALL only consist of numeric, alphabetic upper-case or special characters "#", "-", or "/"
- The total length of the identifier SHALL NOT exceed 30 characters.
- The C/P Identifier would be classified as a "GS1 key" according to the current GS1 definitions. However it is not to be used in open supply chains but can be used as primary identifier in barcoding applications, EPC/RFID and EPCIS.

GS1 key

Required

CPID

The GS1 Application Identifier to indicate the Component/Part Identifier (CPID) is AI (8010), see section [3.2](#).

Rules

The C/P Identifier would be classified as a "GS1 key" according to the current GS1 definitions. However it is not to be used in open supply chains.

Attributes

Required

Not applicable

Optional

The C/P Identifier may be supplemented by an optional serial number. The format of the serial number is numeric only, maximum 12 digits. See GS1 Application Identifier (8011) Component/Part Identifier in section [3.9.11](#) and also for all the GS1 Application Identifiers that may be used with a CPID, see section [3.2](#).

Data carrier specification

Carrier choices

- GS1-128
- GS1 DataMatrix
- GS1 QR Code
- EPC/RFID

Data carrier specifications are to be provided by the OEM to its partners.

Symbol placement

Not applicable

Unique application processing requirements

Not applicable

2.6.13 Global Model Number (GMN)

Application description

The GS1 Global Model Number (GMN) is the GS1 identification key that may be used to identify a product model (e.g., medical device family, apparel style, consumer electronics model) based on attributes common to the model as defined by the brand owner in accordance with industry guidelines (where available) or regulation. The product model is the basis from which related trade items are derived. GMN comprises the GS1 Company Prefix, a model reference and check character pair. The model reference utilises characters from GS1 AI encodable character set 82 and its structure is left to the discretion of the brand owner who assigns it. (see section [3.9.13](#))

This GS1 identification key, once assigned to one product model, SHALL NOT be reissued to another product model. The GMN SHALL NOT be used to identify a trade item. A GMN is an attribute of a trade item identified with a GTIN. A GMN is directly correlated to one or more GTINs, a GTIN SHALL only be associated with one GMN.

The Global Model Number can be used by any industry but for regulated healthcare medical devices the following applies:

Regulated healthcare medical devices

For regulated healthcare medical devices, the GMN is the GS1 identification key to support the implementation of the Basic UDI-DI requirements.

For regulated healthcare medical devices, the Basic UDI-DI serves as the key element in the UDI regulatory database for medical devices.

By providing an identifier for a medical device family, the GMN will link medical device trade item(s) identified by GTIN(s) in the UDI database to pre-market and post-market activities (e.g., certificates, declaration of conformity, vigilance, market surveillance and clinical investigations).

The following points highlight the relationship between Basic UDI-DI (GMN) and UDI-DI (GTIN.)

- Basic UDI-DI (GMN) is used for medical device registration and is assigned independent of packaging/labelling and is different from the identifier for trade items in the supply chain (UDI-DI(GTIN)).
- All Basic UDI-DI (GMN) level attributes (in the UDI regulatory database) are common for all GTINs associated with it.
- All attributes across all UDI-DIs (GTINs) associated with one Basic UDI-DI (GMN) may not be common.
- The Basic UDI-DI (GMN) is used for device registration in the registration database. The UDI-DI (GTIN) is used for trade item identification in the UDI database. UDI-DI (GTIN) and Basic UDI-DI (GMN) allocation may occur before, in parallel, or after each other and attribution and/or linkage between the entities is only possible once both entities exist. For this reason, allocation of UDI-DI (GTIN) and Basic UDI-DI (GMN) shall be made independent of one another.
- Brand owners are responsible for the assignment of Basic UDI-DI (GMN) and UDI-DI (GTIN.)

GS1 key

Required

GMN

The GS1 Application Identifier to indicate the Global Model Number is AI (8013), see section [3.2](#).

Rules

See section [4.12](#).

- The Global Model Number SHALL NOT be used as a replacement for the GTIN.
- The GTIN SHALL NOT be used as a replacement for the Global Model Number.

For regulated healthcare medical devices, the following applies:

- At any given time, the relationship between Basic UDI-DI (GMN) and UDI-DI (GTIN) is 1:n (can be one to one or one to many), meaning a Basic UDI-DI (GMN) can be related to more than one UDI-DI (GTIN).
- Basic UDI-DI (GMN) SHALL NOT be used for supply chain identification or transactional purposes (e.g., labels, orders, deliveries, payments). Only the UDI-DI (GTIN) SHALL be used in the supply chain.
- UDI-DI (GTIN) SHALL NOT be used as a replacement for Basic UDI-DI (GMN).
- In documentation, Basic UDI-DI (GMN) shall be displayed as a single data field, but formatting such as bold or italics may be used within text representation of the identifier to increase efficiency and accuracy of key-entry. Spaces are not permitted as characters in the Basic UDI-DI (GMN).

For construction industry, the following apply:

- The Global Model Number may be processed as stand-alone information where applicable or with a GTIN on the same item. See sections [2.1.7](#) and [4.15](#) for the use of the GMN together with GTIN.

Attributes

Not applicable

Data carrier specification

GMN is a GS1 identification key not intended for use in a data carrier except for the construction industry.

For regulated healthcare medical devices, the Basic UDI-DI (GMN) SHALL NOT be used in any labelling, physical marking, or GS1 AIDC data carrier on trade items associated with the Basic UDI-DI (GMN). The GMN MAY be included on documents or certificates, and in that case the rules for data content, format and data title in [3.9.13](#) apply.

Carrier choices

For the construction industry the following carrier choices apply:

- GS1 DataMatrix
- GS1 QR Code
- EPC/RFID (within user memory only)

 **Note:** If the item is also scanned as a retail trade item a barcode that conforms to retail specifications is required.

Symbol X-dimension, minimum symbol height and minimum symbol quality

See section [5.12.3.4](#), GS1 symbol specification table 4.

Symbol placement

Not applicable

Unique application processing requirements

For a description of processing requirements, see section [7](#).

2.6.14 Permanently marked items

Application description

Some applications require a permanent mark on the item, in order for it to be identified during its full lifetime independent of its packaging. These items may be identified with GIAI, GRAI, or GTIN plus serial number.

Three methods exist for the permanent marking of items:

1. Direct part marking (DPM): The process of marking a symbol directly onto an item using an intrusive or non-intrusive method instead of applying a label or using another indirect marking process. These symbols are typically read from a shorter distance.
2. Durable labelling and marking: The process of marking a symbol onto a label or the item itself that is intended to permanently identify the item, part, or asset (i.e. medical devices, consumer electronics, etc.). These symbols will also appear on items that are tracked and traced for maintenance, repair and overhaul (MRO) purposes. Some of these symbols must withstand harsh environmental conditions and be readable from a long distance, typically more than 3 metres (10 feet).
3. Durable RFID tagging: The process of applying an RFID tag that is intended to remain permanently affixed to the item, part, or asset.

GS1 key

Required

The allowed key formats for this application are:

- GTIN-12
- GTIN-13
- GTIN-14
- GRAI
- GIAI

Rules

See the rules for GTIN, section [4.2](#), and GIAI and GRAI in section [4.4](#).

Attributes

Required

For regulated healthcare consumer trade items the following levels of AIDC marking are specified:

Figure 2.6.14-1. AIDC marking levels for regulated healthcare consumer trade items

AIDC marking level for regulated healthcare trade items	Key	Batch/lot number - AI (10)	Expiration date - AI (17)	Serial number - AI (21)	Other
Highest – Brand owner AIDC marking of certain medical devices	GTIN-12, GTIN-13, or GTIN-14	No	No	Yes	None
Highest - Hospital AIDC marking of certain medical devices (see section 2.1.8)	GRAI, AI (8003), or GIAI, AI (8004), is optional if GTIN, AI (01), + serial number, AI (21), is not marked on the product.	No	No	GRAI, AI (8003), or GIAI, AI (8004), is optional if GTIN, AI (01), + serial number, AI (21), is not marked on the product.	

To manage healthcare data requirements within EPC/RFID tags, see section [3.11](#) and the most recent version of the [EPC Tag Data Standard](#).

Optional

See section 3 for all the GS1 Application Identifiers (AIs) that can be used with a GTIN. Since the GTIN identifies a grouping of items, the optional attributes apply to the grouping as well.

Rules

Not applicable.

Data carrier specification

Carrier choices

- GS1 DataMatrix
- GS1 QR Code
- EPC/RFID

For healthcare, the following carrier selection applies to regulated healthcare retail consumer trade items.

Figure 2.6.14-2. Carrier choices for regulated healthcare retail consumer trade items

Preferred option	GS1 DataMatrix symbology
Option in addition to the barcode	See the "Data carrier specification carrier choices" recommendations on options in addition to the barcode at the end of section 2.1.5

Figure 2.6.14-3. Example of GS1 DataMatrix symbol encoded with GTIN and AIs (17) and (10) per section [2.1.5](#)

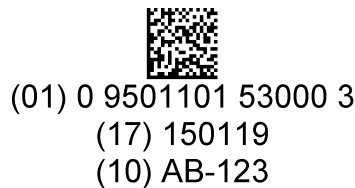

Figure 2.6.14-4. Example of GS1 DataMatrix symbol encoded with GTIN and serial number AI (21)



Symbol X-dimensions, minimum symbol height and minimum symbol quality

Direct part marking:

The use of GS1 DataMatrix and GS1 QR Code in direct part marking applications is endorsed by GS1 for those applications that require permanent marking for cradle-to-grave history of the part's life cycle. For regulated healthcare trade items including medical devices, GS1 DataMatrix is the only GS1 data carrier approved for direct part marking application. These symbols are typically read from a shorter distance.

Some sources express the height of the 2D cell in terms of a Y dimension. For GS1 DataMatrix and GS1 QR Code the cells are considered the same size under optimal print conditions so that X = Y.

Symbol size is determined by the amount of data and the number of rows and columns required encoding the data for the X-dimensions selected (see figures section [5.6.3.2](#)).

Consult *GS1 symbol specification table 7*, section [5.12.3.7](#), for minimum and maximum X-dimensions and other sizing requirements.

Durable labelling and marking:

For long distance scanning see section [5.12.3.13](#), *GS1 symbol specification table 13*.

For short distance scanning see section [5.12.3.9](#), *GS1 symbol specification table 9* (assets) or section [5.12.3.4](#), *GS1 symbol specification table 4* (trade items).

Symbol placement

General principles on placement of barcodes are described in section [6](#).

The majority of uses for these symbols will be on very small items with curved surfaces such as vials, ampoules and very small bottles. For guidance in locating these symbols on curved surfaces, refer to section [6.2](#).

Unique application processing requirements for direct part marking

See section [7](#) and section [5.12.4.3](#).

2.6.15 Encoding transport process information

Introduction

The global Transport & Logistics industry is experiencing exponential growth in freight volumes and becoming ever more open and competitive to support the growing needs. The increasing number of service providers (especially in Last Mile) and new entrants coming in from outside the traditional T&L environment causes challenges within the supply chain where parties involved in a supply chain at times don't even know each other, let alone have integrated systems. The fragmented nature of the industry, connectivity limitations (e.g., internet access) and the need for redundancy (e.g., absence of advance information exchange) drives the need for greater interoperability and the ability to capture transport process information via barcode(s). Information such as ship-to / deliver-to address and other delivery information is encoded directly on the logistic label to support first/last mile and sortation processes.

Note (informative): For further guidance and supporting standards see the [GS1 Encoding Transport Process Information Implementation Guideline](#).

Application description

This application describes the creation of transport unit labels when using 2D barcodes to include necessary transport data on GS1 transport labels. The SSCC is the mandatory identifier required on all transport labels in a GS1-128 barcode and this application defines how it should be used together with optional attributes in 2D barcodes to support transport and logistic processes.

GS1 key

Required

- SSCC

The GS1 Application Identifier for the SSCC is AI (00), see section [3.2](#).

Rules

All SSCC rules described in section [4.3](#).

Attributes

Required

Not applicable

Optional

To provide optional transport process information, see figure below for a listing of GS1 Application Identifiers. For all the GS1 Application Identifiers that may be used with an SSCC in support of encoding transport process information and their format, see section 3.2.

Figure 2.6.15-1. Application Identifiers used to support the transport process

AI	Data Content	Permits Non-Latin Characters
420	Ship-to / Deliver-to postal code with a single postal authority	
4300	Ship-to / Deliver-to company name	X
4301	Ship-to / Deliver-to contact	X
4302	Ship-to / Deliver-to address line 1	X
4303	Ship-to / Deliver-to address line 2	X
4304	Ship-to / Deliver-to suburb	X
4305	Ship-to / Deliver-to locality	X
4306	Ship-to / Deliver-to region	X
4307	Ship-to / Deliver-to country code	
4308	Ship-to / Deliver-to telephone number	
4309	Ship-to / Deliver-to GEO location	
4310	Return-to company name	X
4311	Return-to contact	X
4312	Return-to address line 1	X
4313	Return-to address line 2	X
4314	Return-to suburb	X
4315	Return-to locality	X
4316	Return-to region	X
4317	Return-to country code	
4318	Return-to postal code	
4319	Return-to telephone number	
4320	Service code description	X
4321	Dangerous goods flag	
4322	Authority to leave	
4323	Signature required flag	
4324	Not before delivery date time	
4325	Not after delivery date time	
4326	Release date	
4330	Maximum temperature in Fahrenheit (expressed in hundredths of degrees)	
4331	Maximum temperature in Celsius (expressed in hundredths of degrees)	
4332	Minimum temperature in Fahrenheit (expressed in hundredths of degrees)	
4333	Minimum temperature in Celsius (expressed in hundredths of degrees)	
7041	UN/CEFACT freight unit type	

To encode non-Latin characters within the alphanumeric value, use percent-encoding as defined within [RFC 3986](#). A space character should be encoded as a single plus symbol, +.

Rules

All transport process information rules see section [7](#).

For general human readable interpretation rules see section [4.14](#).

Data carrier specification

Carrier choices

- GS1-128
- GS1 DataMatrix
- GS1 QR Code
- EPC/RFID

The mandatory data carrier used to represent the SSCC on individual logistic units is the GS1-128 barcode symbology.

As indicated by figure [2.6.15](#), 2D barcodes MAY be included in addition to the GS1-128 symbol. When used, the 2D barcode SHALL include all element strings included in the GS1-128 symbol(s) and MAY include additional element strings.

If a logistic unit does not have at least one surface area greater than an A6 or 4" x 6" logistic label (see section [6.6.4.5](#)), a GS1 DataMatrix or GS1 QR Code MAY be used by itself on a logistic label, though a GS1-128 containing a SSCC is still recommended. If a logistic label is used with only a GS1 DataMatrix or GS1 QR Code, care must be taken to ensure trading partners are able to scan this barcode.

Symbol X-dimension, minimum symbol height and minimum symbol quality

For GS1-128, GS1 DataMatrix and GS1 QR Code, see section [5.12.3.5](#) GS1 symbol specification table 5.

Symbol Placement

All the symbol placement guidelines in section [6](#).

Unique application processing requirements

For a description of processing requirements, see section [7](#). Note that some transport process information may include accented / non-Latin characters and space characters which are not available in the subset of *ISO/IEC 646 International Reference Version* defined in figure [7.11-1](#) used for all GS1 Application Identifier (AI) element strings. Encoding these characters can be accomplished using percent encoding as defined in RFC 3986 while using existing characters from the subset of *ISO/IEC 646 International Reference Version* defined in figure [7.11-1](#). Note that space character can be encoded as a plus symbol (+) as an alias of %20.

2.6.16 Digital Signature (DigSig)

Application description

Digital signatures provide the ability to check:

- The data has not been changed (tamper detection)
- The provenance of the data, i.e., who digitally signed the data (non-repudiation)

ISO/IEC 20248: *Information technology — Automatic identification and data capture techniques — Digital signature data structure schema* (<https://www.iso.org/standard/81314.html>) specifies a method to add a digital signature, and other verifiable data, to a barcode or RFID data construct by which the verification of the following can be achieved without the need to connect to an external data source:

- The link with the physical object by using physical features and security marks.

- By using the unique and secured chip ID, it is possible to detect if the data on a specific RFID tag has been cloned from another tag.

An ISO/IEC 20248 data construct is commonly known as a DigSig, a named thing with a specific meaning, while "digital signature" in lower case refers to the general and common digital signature.

Digital signatures can be stored within an AIDC data carrier or retrieved from an online resource. Application Identifier (8030) indicates that its value is an ISO/IEC 20248 DigSig data structure, which is an efficiently compressed data envelope that contains a digital certificate ID, digital signature, timestamp, as well as data. The signature is calculated over some data values that may be present within the DigSig envelope, as well as other data values that need to be sourced from elsewhere, such as entering a PIN number or reading a code from a security marking (e.g., hologram, UV ink mark) on the product, before attempting to verify the signature. In this way, ISO/IEC 20248 supports a strong binding between the digital signature and the physical object to which the data corresponds.

An alternative approach using an online digital signature can support a similarly strong binding to the physical object if the digitally signed data uses properties defined within the GS1 Web vocabulary - see <https://gs1.org/voc/AuthenticityDetails>. In a similar manner to ISO/IEC 20248, it is possible to include a value within the calculation of the digital signature, while omitting it from the data payload, forcing the verifying party to retrieve the missing data value from elsewhere, e.g., from a known PIN number or from a code read from a security marking on the physical object. Formats for online digital signatures include JSON Web Signatures (JWS), XML Signatures or Verifiable Credentials. Resolver infrastructure for GS1 Digital Link can be used (e.g., with `linkType=gs1:jws`) to find sources of digitally signed data for a GS1 Digital Link URI (or for its equivalent element string).



Note: For regulated healthcare trade items, Digital Signature (DigSig) SHALL NOT be used in any labelling, physical marking, or GS1 AIDC data carrier on associated trade items.

The following keys are viable keys for use with a Digital Signature (DigSig).

GS1 Key

Required

The following key formats are allowed in this application:

- GTIN-8
- GTIN-12
- GTIN-13
- GTIN-14
- ITIP
- SSCC
- GRAI
- GIAI
- GSRN (Provider)
- GSRN (Recipient)
- GCN
- GDTI
- CPID

Rules

All application rules, for the relevant GS1 key, are described in section [4](#).

Attributes

Required

AI (8030) Digital Signature (DigSig)

Instance level identification is required in addition to AI (8030), see Table 4-1 Entities identified by GS1 identification keys (simple or compound) within the [GS1 System Architecture document](#).

Optional

Not applicable

Rules

Not applicable

Data carrier specification

Carrier choices

The data carriers required to carry a DigSig are listed below however specifications for data carriers are established with the application standards for the GS1 Identification keys. In some applications, one of the data carriers below are permitted without needing any other data carriers on the entity being identified. In other application standards, one of the data carriers below are permitted in addition to another data carrier that is incapable of encoding DigSig (e.g., EAN/UPC, GS1-128, ITF-14, GS1 DataBar)

- GS1 DataMatrix
- GS1 QR Code
- Data Matrix (GS1 Digital Link URI)
- QR Code (GS1 Digital Link URI)
- EPC/RFID

Symbol X-dimension, minimum symbol height and minimum symbol quality

To determine which Symbol Specification Table is applicable, please refer to the relevant application standard for the required GS1 key, in section [2](#).

Symbol placement

Not applicable

Unique application processing requirements

For a description of processing requirements, see section [7](#).

2.6.17 Restricted application – highly individualised device identifier via Master Unique Device Identifier – Device Identifier (MUDI-DI)

Application description

MUDI-DI meets a EUDAMED registration requirement for highly individualised medical devices. The first published regulatory requirement covers contact lenses, per both Made-to-Stock (standard contact lenses per regulation (EU) 2017/745 as amended 7 October 2023) and Made-to-Order contact lenses. Future regulation may cover additional device types. MUDI-DI permits consolidated EUDAMED registration of standard contact lenses with similar clinical parameters according to identifiers specified per the two scenarios below:

- For devices that are currently identified by GTIN, MUDI-DI, not GTIN, serves as the UDI-DI. For MUDI-DI the Highly Individualised Device Registration Identifier (HIDRI): AI (8014) is used instead of GTIN for device registration within EUDAMED. The Highly Individualised Device Registration Identifier (HIDRI) is a restricted application use of the GS1 Global Model Number (GMN). GTINs allocated according to existing rules associated with AI (01) for Made-to-Stock

trade items, will continue to be used for these devices to support current business processes. Therefore, AI (01) and related UDI-DI production identifiers (e.g., lot number, serial number, production date) would appear with AI (8014) on product labelling for Made-to-Stock contact lenses in the EU.

- For Made-to-Order devices where GTIN is not currently used, a Made-to-Order GTIN SHALL be used in conjunction with a compound key component (e.g., lot number, serial number). This GTIN SHALL be used as the MUDI-DI and therefore the UDI-DI. This GTIN SHALL be qualified using AI (03) not AI (01) to signal scanning/reading systems that the compound GTIN key is required and that the GTIN itself is allocated according to Made-to-Order GTIN rules rather than the current Made-to-Stock rules. This GTIN may be a GTIN-12, GTIN-13 or a GTIN-14, but when it is registered in EUDAMED, it is stored in a 14-digit format.

The MUDI-DI, whether the Highly Individualised Device Registration Identifier (HIDRI) or Made-to-Order GTIN, once assigned, SHALL NOT be reissued.

The MUDI-DI SHALL only be used for standard contact lenses that will be registered in EUDAMED per European regulations and the following applies:

GS1 key

Required

For devices currently utilising GTIN per existing (Made-to-Stock) [GS1 Healthcare GTIN Allocation Rules Standard](#)

- Highly Individualised Device Registration Identifier (HIDRI) SHALL be used as the MUDI-DI (UDI-DI).
- GTIN (SHALL be used for current business processes)

For Made-to-Order devices not currently identified by a GTIN:

- Made-to-Order GTIN SHALL be used as the MUDI-DI (UDI-DI)
- Made-to-Order GTIN in conjunction with a compound key data element (e.g., lot number, serial number) SHALL be used for current business processes where GTIN alone is insufficient to uniquely identify the device)

Rules

See section [4.13](#)

For devices using current [GS1 Healthcare GTIN Allocation Rules Standard](#) used for Made-to-Stock products, GTIN SHALL continue to be used for current business processes and the Highly Individualised Device Registration Identifier (HIDRI) SHALL be used as the MUDI-DI (UDI-DI) according to the following rules:

- The Highly Individualised Device Registration Identifier (HIDRI) SHALL be used as MUDI-DI and SHALL NOT be used to identify the device for the purpose of trade where Global Trade Item Number (GTIN) is used today.
- The GTIN SHALL NOT be used for MUDI-DI registration purposes in EUDAMED where the Highly Individualised Device Registration Identifier (HIDRI) serves as the MUDI-DI (UDI-DI).
- At any given time, the relationship between the Highly Individualised Device Registration Identifier (HIDRI) / (MUDI-DI) and a Made-to-Stock GTIN using AI (01) is 1:n (can be one to one or one to many), meaning the Highly Individualised Device Registration Identifier (HIDRI) / (MUDI-DI) can be related to more than one Made-to-Stock GTIN.
- As the Highly Individualised Device Registration Identifier (HIDRI) is stored within the UDI-DI field within EUDAMED, this element string SHALL contain at least one non-numeric character within the "grouping reference" data structure to ensure against any potential conflict with existing GTINs.
- In documentation, the MUDI-DI shall be displayed per GMN rules found in section [2.6.13](#).
- Allocation of the Highly Individualised Device Registration Identifier (HIDRI) to register a family of Made-to-Stock contact lenses as the MUDI-DI is made per the discretion of the brand owner,

but in compliance with EU regulatory requirements based on the EU Medical Device Regulation (MDR).

For Made-to-Order devices not currently identified by a Made-to-Stock GTIN, a Made-to-Order GTIN SHALL be used as the MUDI-DI (UDI-DI) for EUDAMED registration according to the following rules:

- The Made-to-Order GTIN SHALL be used as a Global Trade Item Number (GTIN) in conjunction with a compound GTIN key component (e.g., lot number, serial number) in order to create a unique trade item identifier.
- The Made-to-Order GTIN SHALL be used for EUDAMED registration purposes as the MUDI-DI (UDI-DI).
- In documentation, the MUDI-DI shall be displayed as a single data field, but formatting such as bold or italics may be used within text representation of the identifier to increase efficiency and accuracy of key-entry.
- Allocation of the Made-to-Order GTIN for a family of Made-to-Order contact lenses is made per the discretion of the brand owner, but in compliance with EU regulatory requirements based on the EU Medical Device Regulation (MDR).
- The same GTIN value SHALL NOT be used with AI (01) and AI (03).

Attributes

Required

Where one Made-to-Order GTIN with AI (03) can support requirements related to specific use by a patient or the purpose of trade, intended use, or point-of-care and EUDAMED registration of highly individualised devices sharing similar characteristics, in the context of the EU UDI requirements for contact lenses, there SHALL BE:

- a. no requirement to conform to the existing [GS1 Healthcare GTIN Allocation Rules Standard](#) and
- b. no mandatory requirement for lot number or serial number (beyond that specified by regulation) to ensure unique identification because there is a one-to-one GTIN to device relationship.

For contact lenses registered using MUDI-DI in EUDAMED, where MUDI-DI is a MtO GTIN, and where the contact lenses must be distinguishable from other contact lenses consolidated by the same MtO GTIN (MUDI-DI) for specific use by a patient or the purpose of trade, intended use, or point-of-care, each contact lens SHALL be uniquely identified and marked. Where one GTIN with AI (03) is used to support EUDAMED registration of highly individualised devices sharing similar characteristics and the GTIN cannot support distinguishing one device from another, there SHALL BE:

- a. no requirement to conform to existing [GS1 Healthcare GTIN Allocation Rules Standard](#) and:
- b. GTIN with another compound key data element that ensures unique identification (e.g., lot number, serial number) SHALL be used to ensure unique identification, for these extra regulatory requirements, because there is a one-to-many GTIN to device relationship.
Optional

See section [3.2](#) - GS1 Application Identifiers in numerical order for a complete list of all GS1 Application Identifiers.

Data carrier specification

Carrier choices

- See the "data carrier specification carrier choices" recommendations on preferred options, options in addition to the barcode and other acceptable options found at the end of Section [2.1.5](#) Healthcare primary packaging (non-retail trade items) which apply to Section [2.1.6](#) Healthcare secondary packaging (regulated healthcare retail consumer trade items) as well.

 **Note:** If the item is also scanned as a retail trade item a barcode that conforms to retail specifications is also required.

Symbol X-dimensions, minimum symbol height and minimum symbol quality

Highly individualised medical devices will require MUDI-DI but the symbol specifications for the device itself SHALL NOT change. These specifications are found in the relevant application standard for the device as determined by the brand owner of the device. For a list of applications and their associated symbol specification tables, see section [2.7](#).

Excerpts of Table 2.7.1 below provide relevant application standards.

Application	See section	SST(s)
Healthcare primary packaging (non-retail trade items)	2.1.5	6
Healthcare secondary packaging (regulated healthcare retail consumer trade items)	2.1.6	8 or 10

Symbol placement

All the symbol placement guidelines defined in section [6](#).

Unique application processing requirements

For a description of processing requirements, see section [7](#).

2.7 Summary of applications and operative scanning environments

The figure below provides a cross-reference for all system applications defined in section 2 and the GS1 symbol specification tables (SSTs) in section [5](#). The application where the barcode will be used needs to be determined prior to locating the correct symbol specification table (SST) entry. Use the "SST(s)" column to find the SST appropriate for the application area. Because most application areas provide a reference to two symbol specification tables based on the operative scanning environment, a decision must be made between the two. See the decision tree in figure [5.12.2.6-2](#) to determine the correct symbol specification table.

Figure 2.7-1. Areas of GS1 system application

Application	See section	SST(s)
Fixed measure trade items scanned at retail POS using:	2.1.3	
GTIN-12 or GTIN-13	2.1.3.1	1
GTIN-12 carried by a UPC-E barcode	2.1.3.2	1
GTIN-8	2.1.3.3	1
Hardcover books and paperbacks scanned at retail POS using ISBN, GTIN-13, or GTIN-12	2.1.3.4	1
Serial publications scanned at retail POS using ISSN, GTIN-13, or GTIN-12	2.1.3.5	1
Fixed measure fresh food trade items scanned at retail POS	2.1.3.6	1
Fixed measure trade items scanned in general distribution and at retail POS	2.1.4	3
Healthcare primary packaging (non-retail trade items)	2.1.5	6
Healthcare secondary packaging (regulated healthcare retail consumer trade items)	2.1.6	8 or 10
Fixed measure trade items scanned in general distribution	2.1.7	2
Regulated healthcare trade items	2.1.7	8
Manufacturing, maintenance, repair and overhaul trade items	2.1.7	4
Medical devices (non-retail trade items)	2.1.8	7

Application	See section	SST(s)
Fixed measure trade items packed in several individual pieces not scanned at retail POS	2.1.9	2, 4
Healthcare trade items	2.1.9	8 or 10
Variable measure trade items scanned in general distribution	2.1.10	2
Fixed measure trade items – restricted distribution applications	2.1.11	
Company internal numbering – RCN-8 Prefix 0 or 2	2.1.11.1	1
Company internal numbering – RCN- 13 GS1 Prefix 04 (RCN-12 U.P.C. Prefix 4)	2.1.11.2	1
Company internal numbering – RCN- 12 U.P.C. Prefix 0 (LAC and RZSC)	2.1.11.3	1
GS1 Prefixes 02, 20 to 29 - Restricted Circulation	2.1.11.4	1
Variable measure fresh food trade items scanned at retail point-of-sale using GTIN	2.1.12.1	1
Variable measure trade items scanned at retail point-of-sale using Restricted Circulation Numbers	2.1.12.2	1
GS1 Digital Link URI syntax for extended packaging applications for trade items	2.1.13.1	1 Addendum 2
GS1 element string syntax for extended packaging applications for trade items	2.1.13.2	1 Addendum 1
Regulated healthcare trade items	2.1.13.2	6, 7, 8, or 10
Regulated trade item, at unit pack level, per EU 2018/574 for tobacco traceability (GTIN + Third-Party Controlled Serialised Extension of GTIN)	2.1.14	12
Regulated trade item, at standard trade grouping level, per EU 2018/574 for tobacco traceability (SGTIN)	2.1.14	12
Regulated logistics unit per EU 2018/574 for tobacco traceability (SSCC)	2.1.14	12
Logistics units - individual logistic units (SSCC)	2.2.1	5
Logistics units - multiple logistic units (GSIN, GINC)	2.2.2, 2.2.3	5
Assets – Global Returnable Asset Identifier (GRAI)	2.3.1	9
Direct part marking	2.3.1, 2.6.14	7
Durable labelling and marking	2.3.1, 2.6.14	9, 13
Assets – Global Individual Asset Identifier (GIAI)	2.3.2	9
Direct part marking	2.3.2 2.6.14	7
Durable labelling and marking	2.3.2 2.6.14	9, 13
Identification of a physical location	2.4.2	9
Service relationships	2.5	11
Use of demographic data to support verification or validation of personal identity	2.5.4	11
Coupons identified using the Global Coupon Number	2.6.2	1
Coupon identification for restricted geographic distribution (GS1 Prefix 99)	2.6.3.3 2.6.3.4	1
GS1 common currency coupon identification (GS1 Prefixes 981 to 983)	2.6.3.5	



Application	See section	SST(s)
Coupon code identification for use in North America (AIs (8110), (8112))	2.6.3.6 2.6.3.7	(*)
Refund receipts	2.6.4	1
Electronic serial identifier for cellular mobile telephones (CMTI): AI (8002)	2.6.5	4
Payment slips	2.6.6	4
Customer specific articles	2.6.7	1
Custom trade item	2.6.8	4
Global Document Type Identifier for document control	2.6.9	9
Internal applications	2.6.10	N/A
Consumer trade item production control	2.6.11	N/A
Component/part identification	2.6.12	N/A
Global Model Number	2.6.13	4
Permanently marked items	2.6.14	4, 7, 9, 13
Encoding transport process information	2.6.15	5
Digital Signature (DigSig) detailed in ISO/IEC 20248	2.6.16	(**)
(*) See <i>US Coupon Application Guideline Using GS1 DataBar Expanded Symbols</i> for the appropriate SST.		
(**) Refer to the application standard of the required GS1 key, for the appropriate SST.		

3 GS1 Application Identifier definitions

3.1 Introduction

This section describes the meaning, structure and function of the GS1 system element strings so they can be correctly processed in users' application programmes. An element string is the combination of a GS1 Application Identifier and a GS1 Application Identifier data field. The allowable character set to be used for GS1 Application Identifier element strings is defined in section 7.11. There are AIs that have additional syntax restrictions, e.g., numerical only; see below definition for each AI.

Automatic processing of element strings in business applications requires information about the type of transaction to which the transferred data refers. See section 7 for an explanation of this process. Element strings can be carried by GS1-128, GS1 DataBar symbology, GS1 Composite, GS1 DataMatrix and GS1 QR Code symbols. The rules for use and interrelationships between the GS1 Application Identifiers are contained in section 2 and 4.

When a predefined length GS1 key and attributes are encoded together, the GS1 key SHOULD appear before the attributes. In most cases predefined length element strings SHOULD be followed by non-predefined element strings. The sequence of predefined and non-predefined element strings should be at the discretion of the creator of the element strings.

3.2 GS1 Application Identifiers in numerical order

Figure 3.2-1. GS1 Application Identifiers

AI	Data Content	Format ⁽¹⁾	FNC1 required ⁽⁴⁾	Data title
00	Identification of a logistic unit (SSCC): AI (00)	N2+N18		SSCC
01	Identification of a trade item (GTIN): AI (01)	N2+N14		GTIN
02	Identification of trade items contained in a logistic unit: AI (02)	N2+N14		CONTENT
03	Identification of a Made-to-Order (MtO) trade item (GTIN): AI (03)	N2+N14		MTO GTIN
10	Batch or lot number: AI (10)	N2+X..20	(FNC1)	BATCH/LOT
11 ⁽²⁾	Production date: AI (11)	N2+N6		PROD DATE
12 ⁽²⁾	Due date for amount on payment slip: AI (12)	N2+N6		DUE DATE
13 ⁽²⁾	Packaging date: AI (13)	N2+N6		PACK DATE
15 ⁽²⁾	Best before date: AI (15)	N2+N6		BEST BEFORE or BEST BY
16 ⁽²⁾	Sell by date: AI (16)	N2+N6		SELL BY
17 ⁽²⁾	Expiration date: AI (17)	N2+N6		USE BY or EXPIRY
20	Internal product variant: AI (20)	N2+N2		VARIANT
21	Serial number: AI (21)	N2+X..20	(FNC1)	SERIAL
22	Consumer product variant: AI (22)	N2+X..20	(FNC1)	CPV
235	Third Party Controlled, Serialised Extension of Global Trade Item Number (GTIN) (TPX): AI (235)	N3+X..28	(FNC1)	TPX
240	Additional product identification assigned by the manufacturer: AI (240)	N3+X..30	(FNC1)	ADDITIONAL ID
241	Customer part number: AI (241)	N3+X..30	(FNC1)	CUST. PART No.
242	Made-to-Order variation number: AI (242)	N3+N..6	(FNC1)	MTO VARIANT
243	Packaging component number: AI (243)	N3+X..20	(FNC1)	PCN
250	Secondary serial number: AI (250)	N3+X..30	(FNC1)	SECONDARY SERIAL
251	Reference to source entity: AI (251)	N3+X..30	(FNC1)	REF. TO SOURCE

AI	Data Content	Format ⁽¹⁾	FNC1 required ⁽⁴⁾	Data title
253	Global Document Type Identifier (GDTI): AI (253)	N3+N13[+X..17]	(FNC1)	GDTI
254	Global Location Number (GLN) extension component: AI (254)	N3+X..20	(FNC1)	GLN EXTENSION COMPONENT
255	Global Coupon Number (GCN): AI (255)	N3+N13[+N..12]	(FNC1)	GCN
30	Variable count of items: AI (30)	N2+N..8	(FNC1)	VAR. COUNT
310n ⁽³⁾	Net weight, kilograms (variable measure trade item)	N4+N6		NET WEIGHT (kg)
311n ⁽³⁾	Length or first dimension, metres (variable measure trade item)	N4+N6		LENGTH (m)
312n ⁽³⁾	Width, diameter, or second dimension, metres (variable measure trade item)	N4+N6		WIDTH (m)
313n ⁽³⁾	Depth, thickness, height, or third dimension, metres (variable measure trade item)	N4+N6		HEIGHT (m)
314n ⁽³⁾	Area, square metres (variable measure trade item)	N4+N6		AREA (m ²)
315n ⁽³⁾	Net volume, litres (variable measure trade item)	N4+N6		NET VOLUME (l)
316n ⁽³⁾	Net volume, cubic metres (variable measure trade item)	N4+N6		NET VOLUME (m ³)
320n ⁽³⁾	Net weight, pounds (variable measure trade item)	N4+N6		NET WEIGHT (lb)
321n ⁽³⁾	Length or first dimension, inches (variable measure trade item)	N4+N6		LENGTH (in)
322n ⁽³⁾	Length or first dimension, feet (variable measure trade item)	N4+N6		LENGTH (ft)
323n ⁽³⁾	Length or first dimension, yards (variable measure trade item)	N4+N6		LENGTH (yd)
324n ⁽³⁾	Width, diameter, or second dimension, inches (variable measure trade item)	N4+N6		WIDTH (in)
325n ⁽³⁾	Width, diameter, or second dimension, feet (variable measure trade item)	N4+N6		WIDTH (ft)
326n ⁽³⁾	Width, diameter, or second dimension, yards (variable measure trade item)	N4+N6		WIDTH (yd)
327n ⁽³⁾	Depth, thickness, height, or third dimension, inches (variable measure trade item)	N4+N6		HEIGHT (in)
328n ⁽³⁾	Depth, thickness, height, or third dimension, feet (variable measure trade item)	N4+N6		HEIGHT (ft)
329n ⁽³⁾	Depth, thickness, height, or third dimension, yards (variable measure trade item)	N4+N6		HEIGHT (yd)
330n ⁽³⁾	Logistic weight, kilograms	N4+N6		GROSS WEIGHT (kg)
331n ⁽³⁾	Length or first dimension, metres	N4+N6		LENGTH (m), log
332n ⁽³⁾	Width, diameter, or second dimension, metres	N4+N6		WIDTH (m), log
333n ⁽³⁾	Depth, thickness, height, or third dimension, metres	N4+N6		HEIGHT (m), log
334n ⁽³⁾	Area, square metres	N4+N6		AREA (m ²), log
335n ⁽³⁾	Logistic volume, litres	N4+N6		VOLUME (l), log
336n ⁽³⁾	Logistic volume, cubic metres	N4+N6		VOLUME (m ³), log
337n ⁽³⁾	Kilograms per square metre	N4+N6		KG PER m ²
340n ⁽³⁾	Logistic weight, pounds	N4+N6		GROSS WEIGHT (lb)
341n ⁽³⁾	Length or first dimension, inches	N4+N6		LENGTH (in), log
342n ⁽³⁾	Length or first dimension, feet	N4+N6		LENGTH (ft), log
343n ⁽³⁾	Length or first dimension, yards	N4+N6		LENGTH (yd), log

AI	Data Content	Format ⁽¹⁾	FNC1 required ⁽⁴⁾	Data title
344n ⁽³⁾	Width, diameter, or second dimension, inches	N4+N6		WIDTH (in), log
345n ⁽³⁾	Width, diameter, or second dimension, feet	N4+N6		WIDTH (ft), log
346n ⁽³⁾	Width, diameter, or second dimension, yard	N4+N6		WIDTH (yd), log
347n ⁽³⁾	Depth, thickness, height, or third dimension, inches	N4+N6		HEIGHT (in), log
348n ⁽³⁾	Depth, thickness, height, or third dimension, feet	N4+N6		HEIGHT (ft), log
349n ⁽³⁾	Depth, thickness, height, or third dimension, yards	N4+N6		HEIGHT (yd), log
350n ⁽³⁾	Area, square inches (variable measure trade item)	N4+N6		AREA (in ²)
351n ⁽³⁾	Area, square feet (variable measure trade item)	N4+N6		AREA (ft ²)
352n ⁽³⁾	Area, square yards (variable measure trade item)	N4+N6		AREA (yd ²)
353n ⁽³⁾	Area, square inches	N4+N6		AREA (in ²), log
354n ⁽³⁾	Area, square feet	N4+N6		AREA (ft ²), log
355n ⁽³⁾	Area, square yards	N4+N6		AREA (yd ²), log
356n ⁽³⁾	Net weight, troy ounces (variable measure trade item)	N4+N6		NET WEIGHT (t)
357n ⁽³⁾	Net weight (or volume), ounces (variable measure trade item)	N4+N6		NET VOLUME (oz)
360n ⁽³⁾	Net volume, quarts (variable measure trade item)	N4+N6		NET VOLUME (q)
361n ⁽³⁾	Net volume, gallons U.S. (variable measure trade item)	N4+N6		NET VOLUME (g)
362n ⁽³⁾	Logistic volume, quarts	N4+N6		VOLUME (q), log
363n ⁽³⁾	Logistic volume, gallons U.S.	N4+N6		VOLUME (g), log
364n ⁽³⁾	Net volume, cubic inches (variable measure trade item)	N4+N6		VOLUME (in ³)
365n ⁽³⁾	Net volume, cubic feet (variable measure trade item)	N4+N6		VOLUME (ft ³)
366n ⁽³⁾	Net volume, cubic yards (variable measure trade item)	N4+N6		VOLUME (yd ³)
367n ⁽³⁾	Logistic volume, cubic inches	N4+N6		VOLUME (in ³), log
368n ⁽³⁾	Logistic volume, cubic feet	N4+N6		VOLUME (ft ³), log
369n ⁽³⁾	Logistic volume, cubic yards	N4+N6		VOLUME (yd ³), log
37	Count of trade items or trade item pieces contained in a logistic unit: AI (37)	N2+N..8	(FNC1)	COUNT
390n ⁽³⁾	Amount payable or coupon value - Single monetary area: AI (390n)	N4+N..15	(FNC1)	AMOUNT
391n ⁽³⁾	Amount payable and ISO currency code: AI (391n)	N4+N3+N..15	(FNC1)	AMOUNT
392n ⁽³⁾	Amount payable for a variable measure trade item - Single monetary area: AI (392n)	N4+N..15	(FNC1)	PRICE
393n ⁽³⁾	Amount payable for a variable measure trade item and ISO currency code: AI (393n)	N4+N3+N..15	(FNC1)	PRICE
394n ⁽³⁾	Percentage discount of a coupon: AI (394n)	N4+N4	(FNC1)	PRCNT OFF
395n ⁽³⁾	Amount payable per unit of measure single monetary area (variable measure trade item): AI (395n)	N4+N6	(FNC1)	PRICE/UoM
400	Customer's purchase order number: AI (400)	N3+X..30	(FNC1)	ORDER NUMBER

AI	Data Content	Format ⁽¹⁾	FNC1 required ⁽⁴⁾	Data title
401	Global Identification Number for Consignment (GINC): AI (401)	N3+X..30	(FNC1)	GINC
402	Global Shipment Identification Number (GSIN): AI (402)	N3+N17	(FNC1)	GSIN
403	Routing code: AI (403)	N3+X..30	(FNC1)	ROUTE
410	Ship to - Deliver to Global Location Number (GLN): AI (410)	N3+N13		SHIP TO LOC
411	Bill to - Invoice to Global Location Number (GLN): AI (411)	N3+N13		BILL TO
412	Purchased from Global Location Number (GLN): AI (412)	N3+N13		PURCHASE FROM
413	Ship for - Deliver for - Forward to Global Location Number (GLN): AI (413)	N3+N13		SHIP FOR LOC
414	Identification of a physical location - Global Location Number (GLN): AI (414)	N3+N13		LOC No.
415	Global Location Number (GLN) of the invoicing party: AI (415)	N3+N13		PAY TO
416	Global Location Number (GLN) of the production or service location: AI (416)	N3+N13		PROD/SERV LOC
417	Party Global Location Number (GLN): AI (417)	N3+N13		PARTY
420	Ship-to / Deliver-to postal code within a single postal authority: AI (420)	N3+X..20	(FNC1)	SHIP TO POST
421	Ship-to / Deliver-to postal code with three-digit ISO country code: AI (421)	N3+N3+X..9	(FNC1)	SHIP TO POST
422	Country of origin of a trade item: AI (422)	N3+N3	(FNC1)	ORIGIN
423	Country of initial processing: AI (423)	N3+N3+N..12	(FNC1)	COUNTRY - INITIAL PROCESS
424	Country of processing: AI (424)	N3+N3	(FNC1)	COUNTRY - PROCESS
425	Country of disassembly: AI (425)	N3+N3+N..12	(FNC1)	COUNTRY - DISASSEMBLY
426	Country covering full process chain: AI (426)	N3+N3	(FNC1)	COUNTRY - FULL PROCESS
427	Country subdivision of origin code for a trade item: AI (427)	N3+X..3	(FNC1)	ORIGIN SUBDIVISION
4300	Ship-to / Deliver-to Company name: AI (4300)	N4+X..35	(FNC1)	SHIP TO COMP
4301	Ship-to / Deliver-to contact name: AI (4301)	N4+X..35	(FNC1)	SHIP TO NAME
4302	Ship-to / Deliver-to address line 1: AI (4302)	N4+X..70	(FNC1)	SHIP TO ADD1
4303	Ship-to / Deliver-to address line 2: AI (4303)	N4+X..70	(FNC1)	SHIP TO ADD2
4304	Ship-to / Deliver-to suburb: AI (4304)	N4+X..70	(FNC1)	SHIP TO SUB
4305	Ship-to / Deliver-to locality: AI (4305)	N4+X..70	(FNC1)	SHIP TO LOC
4306	Ship-to / Deliver-to region: AI (4306)	N4+X..70	(FNC1)	SHIP TO REG
4307	Ship-to / Deliver-to country code: AI (4307)	N4+X2	(FNC1)	SHIP TO COUNTRY
4308	Ship-to / Deliver-to telephone number: AI (4308)	N4+X..30	(FNC1)	SHIP TO PHONE
4309	Ship-to / Deliver-to GEO location: AI (4309)	N4+N20	(FNC1)	SHIP TO GEO
4310	Return-to company name: AI (4310)	N4+X..35	(FNC1)	RTN TO COMP
4311	Return-to contact name: AI (4311)	N4+X..35	(FNC1)	RTN TO NAME
4312	Return-to address line 1: AI (4312)	N4+X..70	(FNC1)	RTN TO ADD1
4313	Return-to address line 2: AI (4313)	N4+X..70	(FNC1)	RTN TO ADD2
4314	Return-to suburb: AI (4314)	N4+X..70	(FNC1)	RTN TO SUB
4315	Return-to locality: AI (4315)	N4+X..70	(FNC1)	RTN TO LOC

AI	Data Content	Format ⁽¹⁾	FNC1 required ⁽⁴⁾	Data title
4316	Return-to region: AI (4316)	N4+X..70	(FNC1)	RTN TO REG
4317	Return-to country code: AI (4317)	N4+X2	(FNC1)	RTN TO COUNTRY
4318	Return-to postal code: AI (4318)	N4+X..20	(FNC1)	RTN TO POST
4319	Return-to telephone number: AI (4319)	N4+X..30	(FNC1)	RTN TO PHONE
4320	Service code description: AI (4320)	N4+X..35	(FNC1)	SRV DESCRIPTION
4321	Dangerous goods flag: AI (4321)	N4+N1	(FNC1)	DANGEROUS GOODS
4322	Authority to leave flag: AI (4322)	N4+N1	(FNC1)	AUTH LEAVE
4323	Signature required flag: AI (4323)	N4+N1	(FNC1)	SIG REQUIRED
4324	Not before delivery date/time: AI (4324)	N4+N10	(FNC1)	NBEF DEL DT
4325	Not after delivery date/time: AI (4325)	N4+N10	(FNC1)	NAFT DEL DT
4326	Release date: AI (4326)	N4+N6	(FNC1)	REL DATE
4330 ⁽⁷⁾	Maximum temperature in Fahrenheit: AI (4330)	N4+N6+[-]	(FNC1)	MAX TEMP F
4331 ⁽⁷⁾	Maximum temperature in Celsius: AI (4331)	N4+N6+[-]	(FNC1)	MAX TEMP C
4332 ⁽⁷⁾	Minimum temperature in Fahrenheit: AI (4332)	N4+N6+[-]	(FNC1)	MIN TEMP F
4333 ⁽⁷⁾	Minimum temperature in Celsius: AI (4333)	N4+N6+[-]	(FNC1)	MIN TEMP C
7001	NATO Stock Number (NSN): AI (7001)	N4+N13	(FNC1)	NSN
7002	UNECE meat carcasses and cuts classification: AI (7002)	N4+X..30	(FNC1)	MEAT CUT
7003	Expiration date and time: AI (7003)	N4+N10	(FNC1)	EXPIRY TIME
7004	Active potency: AI (7004)	N4+N..4	(FNC1)	ACTIVE POTENCY
7005	Catch area: AI (7005)	N4+X..12	(FNC1)	CATCH AREA
7006	First freeze date: AI (7006)	N4+N6	(FNC1)	FIRST FREEZE DATE
7007	Harvest date: AI (7007)	N4+N6[+N6]	(FNC1)	HARVEST DATE
7008	Species for fishery purposes: AI (7008)	N4+X..3	(FNC1)	AQUATIC SPECIES
7009	Fishing gear type: AI (7009)	N4+X..10	(FNC1)	FISHING GEAR TYPE
7010	Production method: AI (7010)	N4+X..2	(FNC1)	PROD METHOD
7011	Test by date: AI (7011)	N4+N6[+N4]	(FNC1)	TEST BY DATE
7020	Refurbishment lot ID: AI (7020)	N4+X..20	(FNC1)	REFURB LOT
7021	Functional status: AI (7021)	N4+X..20	(FNC1)	FUNC STAT
7022	Revision status: AI (7022)	N4+X..20	(FNC1)	REV STAT
7023	Global Individual Asset Identifier of an assembly: AI (7023)	N4+X..30	(FNC1)	GIAI – ASSEMBLY
703s ⁽⁶⁾	Number of processor with three-digit ISO country code: AI (703s)	N4+N3+X..27	(FNC1)	PROCESSOR # s
7040	GS1 UIC with Extension 1 and Importer index: AI (7040)	N4+N1+X3	(FNC1)	UIC+EXT
7041	UN/CEFACT freight unit type: AI (7041)	N4+X..4	(FNC1)	UFRGT UNIT TYPE
710	National Healthcare Reimbursement Number (NHRN) – Germany PZN: AI (710)	N3+X..20	(FNC1)	NHRN PZN
711	National Healthcare Reimbursement Number (NHRN) – France CIP: AI (711)	N3+X..20	(FNC1)	NHRN CIP
712	National Healthcare Reimbursement Number (NHRN) – Spain CN: AI (712)	N3+X..20	(FNC1)	NHRN CN
713	National Healthcare Reimbursement Number (NHRN) – Brasil DRN: AI (713)	N3+X..20	(FNC1)	NHRN DRN
714	National Healthcare Reimbursement Number (NHRN) – Portugal AIM: AI (714)	N3+X..20	(FNC1)	NHRN AIM

AI	Data Content	Format ⁽¹⁾	FNC1 required ⁽⁴⁾	Data title
715	National Healthcare Reimbursement Number (NHRN) – United States of America NDC: AI (715)	N3+X..20	(FNC1)	NHRN NDC
716	National Healthcare Reimbursement Number (NHRN) – Italy AIC: AI (716)	N3+X..20	(FNC1)	NHRN AIC
... ⁽⁵⁾	National Healthcare Reimbursement Number (NHRN) – Country “A” NHRN	N3+X..20	(FNC1)	NHRN xxx
723s ⁽⁶⁾	Certification reference: AI (723s)	N4+X2+X..28	(FNC1)	CERT # s
7240	Protocol ID: AI (7240)	N4+X..20	(FNC1)	PROTOCOL
7241	AIDC media type: AI (7241)	N4+N2	(FNC1)	AIDC MEDIA TYPE
7242	Version Control Number (VCN): AI (7242)	N4+X..25	(FNC1)	VCN
7250	Date of birth: AI (7250)	N4+N8	(FNC1)	DOB
7251	Date and time of birth: AI (7251)	N4+N12	(FNC1)	DOB TIME
7252	Biological sex: AI (7252)	N4+N1	(FNC1)	BIO SEX
7253	Family name of person: AI (7253)	N4+X..40	(FNC1)	FAMILY NAME
7254	Given name of person: AI (7254)	N4+X..40	(FNC1)	GIVEN NAME
7255	Name suffix of person: AI (7255)	N4+X..10	(FNC1)	SUFFIX
7256	Full name of person: AI (7256)	N4+X..90	(FNC1)	FULL NAME
7257	Address of person: AI (7257)	N4+X..70	(FNC1)	PERSON ADDR
7258	Baby birth sequence indicator: AI (7258)	N4+N1+X1+N1	(FNC1)	BIRTH SEQUENCE
7259	Baby of family name: AI (7259)	N4+X..40	(FNC1)	BABY
8001	Roll products - width, length, core diameter, direction, splices: AI (8001)	N4+N14	(FNC1)	DIMENSIONS
8002	Cellular mobile telephone identifier: AI (8002)	N4+X..20	(FNC1)	CMT No.
8003	Global Returnable Asset Identifier (GRAI): AI (8003)	N4+N14[+X..16]	(FNC1)	GRAI
8004	Global Individual Asset Identifier (GIAI): AI (8004)	N4+X..30	(FNC1)	GIAI
8005	Price per unit of measure: AI (8005)	N4+N6	(FNC1)	PRICE PER UNIT
8006	Identification of an individual trade item (ITIP) piece: AI (8006)	N4+N14+N2+N2	(FNC1)	ITIP
8007	International Bank Account Number (IBAN): AI (8007)	N4+X..34	(FNC1)	IBAN
8008	Date and time of production: AI (8008)	N4+N8[+N..4]	(FNC1)	PROD TIME
8009	Optically readable sensor indicator: AI (8009)	N4+X..50	(FNC1)	OPTSEN
8010	Component/Part Identifier (CPID): AI (8010)	N4+Y..30	(FNC1)	CPID
8011	Component/Part Identifier serial number: AI (8011)	N4+N..12	(FNC1)	CPID SERIAL
8012	Software version: AI (8012)	N4+X..20	(FNC1)	VERSION
8013	Global Model Number (GMN): AI (8013)	N4+X..25	(FNC1)	GMN
8014	Highly Individualised Device Registration Identifier (HIDRI): AI (8014)	N4+X..25	(FNC1)	MUDI
8017	Global Service Relation Number (GSRN) to identify the relationship between an organisation offering services and the provider of services: AI (8017)	N4+N18	(FNC1)	GSRN - PROVIDER
8018	Global Service Relation Number (GSRN) to identify the relationship between an organisation offering services and the recipient of services: AI (8018)	N4+N18	(FNC1)	GSRN - RECIPIENT

AI	Data Content	Format ⁽¹⁾	FNC1 required ⁽⁴⁾	Data title
8019	Service Relation Instance Number (SRIN): AI (8019)	N4+N..10	(FNC1)	SRIN
8020	Payment slip reference number: AI (8020)	N4+X..25	(FNC1)	REF No.
8026	Identification of pieces of a trade item (ITIP) contained in a logistic unit: AI (8026)	N4+N14+N2+N2	(FNC1)	ITIP CONTENT
8030	Digital Signature (DigSig): AI (8030)	N4+Z..90	(FNC1)	DIGSIG
8110	Coupon code identification for use in North America (AI 8110)	N4+X..70	(FNC1)	-
8111	Loyalty points of a coupon: AI (8111)	N4+N4	(FNC1)	POINTS
8112	Positive offer file coupon code identification for use in North America: (AI 8112)	N4+X..70	(FNC1)	-
8200	Extended packaging URL: AI (8200)	N4+X..70	(FNC1)	PRODUCT URL
90	Information mutually agreed between trading partners: AI (90)	N2+X..30	(FNC1)	INTERNAL
91 to 99	Company internal information: AIs (91 - 99)	N2+X..90	(FNC1)	INTERNAL

NOTES:

(1): The first position indicates the length (number of digits) of the GS1 Application Identifier. The following value refers to the format of the data content. The following convention is applied:

- n implied decimal point position
- N numeric digit
- X any character in figure [7.11-1](#) for GS1 AI encodable character set 82
- Y any character in figure [7.11-2](#) for GS1 AI encodable character set 39
- Z any character in figure [7.11-3](#) for GS1 AI encodable character set 64 (file-safe / URI-safe base64)
- N2 2 numeric digits, fixed length
- N3 3 numeric digits, fixed length
- N4 4 numeric digits, fixed length
- X3 3 characters, fixed length
- N..3 up to 3 numeric digits
- X..3 up to 3 characters in figure [7.11-1](#) for GS1 AI encodable character set 82
- Y..3 up to 3 characters in figure [7.11-2](#) for GS1 AI encodable character set 39
- Z..3 up to 3 characters in figure [7.11-3](#) for GS1 AI encodable character set 64 (file-safe / URI-safe base64)
- [] enclosed value is an optional component

(2): If only year and month are available, DD must be filled with two zeroes, except where noted.

(3): The fourth digit of this GS1 Application Identifier indicates the number of decimal places (and in that way the implied decimal point position).

Example:

- 3100 Net weight in kg without a decimal point
- 3102 Net weight in kg with two decimal places
see section [7.8.7](#) for further information.

(4): All GS1 element strings that begin with GS1 Application Identifiers not contained in the predefined table shown in figure [7.8.5-2](#) SHALL be separated by a separator character unless this element string is the last one to be encoded in the symbol. For details on the separator character see section [7.8.4](#).

(5) An example to illustrate future additional National Healthcare Reimbursement Numbers (NHRNs). If additional NHRN AIs are required, a request for a new NHRN AI SHALL be made through GSMP.

(6) The fourth digit of this GS1 Application Identifier indicates the sequence number, allowing for multiple occurrences of the AI.

(7) The temperatures in these GS1 Application Identifiers are expressed in hundredths of degrees.

3.3 GS1 Application Identifiers starting with digit 0

3.3.1 Identification of a logistic unit (SSCC): AI (00)

The GS1 Application Identifier (00) indicates that the GS1 Application Identifier data field contains an SSCC (Serial Shipping Container Code). The SSCC is used to identify logistic units (see section 2.2).

The extension digit is used to increase the capacity of the serial reference within the SSCC. It is assigned by the company that constructs the SSCC. The extension digit ranges from 0-9.

The GS1 Company Prefix is allocated by GS1 Member Organisations to the company that allocates the SSCC – here the physical builder or the brand owner of the logistic unit (see section 1.4.4). It makes the SSCC unique worldwide but does not identify the origin of the unit.

The structure and content of the serial reference is at the discretion of owner of the GS1 Company Prefix to uniquely identify each logistic unit.

The check digit is explained in section 7.9. Its verification, which must be carried out in the application software, ensures that the number is correctly composed.

Figure 3.3.1-1. Format of the element string

GS1 Application Identifier	SSCC (Serial Shipping Container Code)																	
	Extension digit	GS1 Company Prefix										Serial reference					Check digit	
0 0	N ₁	N ₂	N ₃	N ₄	N ₅	N ₆	N ₇	N ₈	N ₉	N ₁₀	N ₁₁	N ₁₂	N ₁₃	N ₁₄	N ₁₅	N ₁₆	N ₁₇	N ₁₈

The data transmitted from the barcode reader means that the element string denoting the SSCC of a logistic unit has been captured. When indicating this element string in the non-HRI text section of a barcode label, the following data title SHOULD be used: **SSCC**

3.3.2 Identification of a trade item (GTIN): AI (01)

The GS1 Application Identifier (01) indicates that the GS1 Application Identifier data field contains a GTIN. The GTIN is used to identify trade items (see section 2.1). The GTIN for trade items may be a GTIN-8, GTIN-12, GTIN-13 or a GTIN-14. See section 2.1 for the rules for GTIN formats and mandatory or optional attributes in the various trade item applications.

The check digit is explained in section 7.9. Its verification, which must be carried out in the application software, ensures that the number is correctly composed.

Figure 3.3.2-1. Format of the element string

	GS1 Application Identifier	Global Trade Item Number (GTIN)													
		GS1-8 Prefix or GS1 Company Prefix								Item reference					Check digit
(GTIN-8)	0 1	0	0	0	0	0	0	N ₁	N ₂	N ₃	N ₄	N ₅	N ₆	N ₇	N ₈
(GTIN-12)	0 1	0	0	N ₁	N ₂	N ₃	N ₄	N ₅	N ₆	N ₇	N ₈	N ₉	N ₁₀	N ₁₁	N ₁₂
(GTIN-13)	0 1	0	N ₁	N ₂	N ₃	N ₄	N ₅	N ₆	N ₇	N ₈	N ₉	N ₁₀	N ₁₁	N ₁₂	N ₁₃
(GTIN-14)	0 1	N ₁	N ₂	N ₃	N ₄	N ₅	N ₆	N ₇	N ₈	N ₉	N ₁₀	N ₁₁	N ₁₂	N ₁₃	N ₁₄

The data transmitted from the barcode reader means that the element string denoting the GTIN of a trade item has been captured.

When indicating this element string in the non-HRI text section of a barcode label, the following data title SHOULD be used: **GTIN**

3.3.3 Identification of trade items contained in a logistic unit: AI (02)

The GS1 Application Identifier (02) indicates that the GS1 Application Identifier data field includes the GTIN of the contained trade items. The GTIN is used to identify trade items (see section 4).

The GTIN for trade items may be a GTIN-8, GTIN-12, GTIN-13 or a GTIN-14. See section 2 for the rules for GTIN formats and mandatory or optional attributes in the various trade item applications.

The GTIN of the trade items contained is the GTIN of the highest level of trade item contained in the logistic unit.

Note: This element string SHALL be used only on a logistic unit if:

- the logistic unit is not itself a trade item; and
- all trade items that are contained at the highest level have the same GTIN.

The check digit is explained in section 7.9. Its verification, which must be carried out in the application software, ensures that the number is correctly composed.

Figure 3.3.3-1. Format of the element string

	GS1 Application Identifier	Global Trade Item Number (GTIN)													Check digit
		GS1-8 Prefix or GS1 Company Prefix							Item reference						
(GTIN-8)	0 2	0	0	0	0	0	0	N ₁	N ₂	N ₃	N ₄	N ₅	N ₆	N ₇	N ₈
(GTIN-12)	0 2	0	0	N ₁	N ₂	N ₃	N ₄	N ₅	N ₆	N ₇	N ₈	N ₉	N ₁₀	N ₁₁	N ₁₂
(GTIN-13)	0 2	0	N ₁	N ₂	N ₃	N ₄	N ₅	N ₆	N ₇	N ₈	N ₉	N ₁₀	N ₁₁	N ₁₂	N ₁₃
(GTIN-14)	0 2	N ₁	N ₂	N ₃	N ₄	N ₅	N ₆	N ₇	N ₈	N ₉	N ₁₀	N ₁₁	N ₁₂	N ₁₃	N ₁₄

The data transmitted from the barcode reader means that the element string denoting the GTIN of trade items contained in a logistic unit has been captured.

This element string must be processed together with the count of trade items, AI (37), which must appear on the same unit (see section 3.6.5). Restrictions apply to the use of AI (02) in combination with other AIs, see section 4.13 Data relationships.

When indicating this element string in the non-HRI text section of a barcode label, the following data title SHOULD be used: **CONTENT**

3.3.4 Identification of a Made-to-Order (MtO) trade item (GTIN): AI (03)

The GS1 Application Identifier (03) indicates that the GS1 Application Identifier data field contains an Identification of a Made-to-Order (MtO) trade item (GTIN). The Identification of a Made-to-Order (MtO) trade item (GTIN) is used to identify trade items (see section 2.6.17). This GTIN may be a GTIN-12, GTIN-13 or a GTIN-14, see section 2.6.17 for the rules for GTIN formats and mandatory or optional attributes in the various trade item applications.

The check digit is explained in section 7.9. Its verification, which must be carried out in the application software, ensures that the number is correctly composed.

Figure 3.3.4-1. Format of the element string

	GS1 Application Identifier	Identification of a Made-to-Order (MtO) trade item (GTIN)													Check digit
		GS1 Company Prefix							Item reference						
(GTIN-12)	0 3	0	0	N ₁	N ₂	N ₃	N ₄	N ₅	N ₆	N ₇	N ₈	N ₉	N ₁₀	N ₁₁	N ₁₂
(GTIN-13)	0 3	0	N ₁	N ₂	N ₃	N ₄	N ₅	N ₆	N ₇	N ₈	N ₉	N ₁₀	N ₁₁	N ₁₂	N ₁₃
(GTIN-14)	0 3	N ₁	N ₂	N ₃	N ₄	N ₅	N ₆	N ₇	N ₈	N ₉	N ₁₀	N ₁₁	N ₁₂	N ₁₃	N ₁₄

NOTE: GTIN-8 (see section 4.2.7) is not an option for Made-to-Order GTIN.

The data transmitted from the barcode reader means that the element string denoting the GTIN of a Made-to-Order trade item has been captured.

When indicating this element string in the non-HRI text section of a barcode label, the following data title SHOULD be used: **MTO GTIN**

3.4 GS1 Application Identifiers starting with digit 1

3.4.1 Batch or lot number: AI (10)

The GS1 Application Identifier (10) indicates that the GS1 Application Identifier data field contains a batch or lot number. The batch or lot number associates an item with information the manufacturer considers relevant for traceability of the trade item to which the element string is applied. The data may refer to the trade item itself or to items contained. The number may be, for example, a production lot number, a shift number, a machine number, a time, or an internal production code. In cases where the same product is manufactured in different locations the brand owner and the manufacturer are responsible for ensuring the non-duplication of batch/lot numbers for a GTIN. For the re-use of batch/lot numbers with a GTIN, sector-specific constraints need to be considered.

The data is alphanumeric and may include all characters contained in figure [7.11-1](#).

 **Note:** The batch or lot number is not part of the unique identification of a trade item.

Figure 3.4.1-1. Format of the element string

GS1 Application Identifier	Batch or lot number
1 0	X ₁ —————> variable length —————>X ₂₀

The data transmitted by the barcode reader means that the element string denoting a batch or lot number has been captured. As this element string is an attribute of a particular item, it must be processed together with the GTIN of the trade item to which it relates (see section [4.13.2](#)). When indicating this element string in the non-HRI text section of a barcode label, the following data title SHOULD be used: **BATCH/LOT**

3.4.2 Production date: AI (11)

The GS1 Application Identifier (11) indicates that the GS1 Application Identifier data field contains a production date. The production date is the production or assembly date determined by the manufacturer. The date may refer to the trade item itself or to items contained. The structure is:

- Year: the tens and units of the year (e.g., 2003 = 03), which is mandatory.
- Month: the number of the month (e.g., January = 01), which is mandatory.
- Day: the number of the day of the relevant month (e.g., second day = 02); if it is not necessary to specify the day, the field must be filled with two zeroes.

 **Note:** When it is not necessary to specify the day (the day field is filled with two zeroes), the resultant data string SHALL be interpreted as the last day of the noted month including any adjustment for leap years (e.g., "130200" is "2013 February 28", "160200" is "2016 February 29", etc.).

 **Note:** How the day of the month is expressed for regulated healthcare products will change starting 1 January 2025. As of that date the day of the month SHALL NOT be expressed as two zeroes. A valid day of the month (e.g., last day of July = 31) SHALL be included.

 **Note:** This element string can only specify dates ranging from 49 years in the past to 50 years in the future. Determination of the correct century is explained in section [7.12](#).

Figure 3.4.2-1. Format of the element string

GS1 Application Identifier	Production date		
	Year	Month	Day
1 1	N ₁ N ₂	N ₃ N ₄	N ₅ N ₆

The data transmitted from the barcode reader means that the element string denoting a production date has been captured. As this element string is an attribute of a trade item, it must be processed together with the GTIN of the trade item to which it relates (see section [4.13 Data relationships](#)). When indicating this element string in the non-HRI text section of a barcode label, the following data title SHOULD be used: **PROD DATE**

3.4.3 Due date for amount on payment slip: AI (12)

The GS1 Application Identifier (12) indicates that the GS1 Application Identifier data field contains the date by which an invoice should be paid. This data element represents an attribute of a payment slip reference number, AI (8020), and a Global Location Number (GLN) of the invoicing party. The structure is:

- Year: the tens and units of the year (e.g., 1998 = 98), which is mandatory.
 - Month: the number of the month (e.g., January = 01), which is mandatory.
 - Day: the number of the day of the relevant month (e.g., second day = 02); if it is not necessary to specify the day, the field must be filled with two zeroes.
- ✓ **Note:** When it is not necessary to specify the day (the day field is filled with two zeroes), the resultant data string SHALL be interpreted as the last day of the noted month including any adjustment for leap years (e.g., "130200" is "2013 February 28", "160200" is "2016 February 29", etc.).
- ✓ **Note:** This element string can only specify dates ranging from 49 years in the past to 50 years in the future. Determination of the correct century is explained in section [7.12](#).

Figure 3.4.3-1. Format of the element string

GS1 Application Identifier	Due date		
	Year	Month	Day
1 2	N ₁ N ₂	N ₃ N ₄	N ₅ N ₆

The data transmitted from the barcode reader means that the element string denoting a due date has been captured. Restrictions apply to the use of this AI in combination with other AIs, see section [4.13 Data relationships](#).

When indicating this element string in the non-HRI text section of a barcode label, the following data title SHOULD be used: **DUE DATE**

3.4.4 Packaging date: AI (13)

The GS1 Application Identifier (13) indicates that the GS1 Application Identifier data fields contain a packaging date. The packaging date is the date when the goods were packed as determined by the packager. The date may refer to the trade item itself or to items contained. The structure is:

- Year: the tens and units of the year (e.g., 2003 = 03), which is mandatory.
- Month: the number of the month (e.g., January = 01), which is mandatory.
- Day: the number of the day of the relevant month (e.g., second day = 02); if it is not necessary to specify the day, the field must be filled with two zeroes.

- ✔ **Note:** When it is not necessary to specify the day (the day field is filled with two zeroes), the resultant data string SHALL be interpreted as the last day of the noted month including any adjustment for leap years (e.g., "130200" is "2013 February 28", "160200" is "2016 February 29", etc.).
- ✔ **Note:** This element string can only specify dates ranging from 49 years in the past to 50 years in the future. Determination of the correct century is explained in section [7.12](#).

Figure 3.4.4-1. Format of the element string

GS1 Application Identifier	Packaging date		
	Year	Month	Day
1 3	N ₁ N ₂	N ₃ N ₄	N ₅ N ₆

The data transmitted from the barcode reader means that the element string denoting a packaging date has been captured. As this element string is an attribute of a trade item, it must be processed together with the GTIN of the trade item to which it relates (see section [4.13 Data relationships](#)). When indicating this element string in the non-HRI text section of a barcode label, the following data title SHOULD be used: **PACK DATE**

3.4.5 Best before date: AI (15)

The GS1 Application Identifier (15) indicates that the GS1 Application Identifier data fields contain a best before date. Best before date on the label or package signifies the end of the period under which the product will retain specific quality attributes or claims even though the product may continue to retain positive quality attributes after this date. Best before date is primarily used for consumer information and may be a regulatory requirement.

- ✔ **Note:** A retailer may use this to determine a date after which they will no longer merchandise the product. Currently, there are implementations of best before date which are interpreted in their processes as the date to sell by.

The structure is:

- Year: the tens and units of the year (e.g., 2003 = 03), which is mandatory.
- Month: the number of the month (e.g., January = 01), which is mandatory.
- Day: the number of the day of the relevant month (e.g., second day = 02); if it is not necessary to specify the day, the field must be filled with two zeroes.

- ✔ **Note:** When it is not necessary to specify the day (the Day field is filled with two zeroes), the resultant data string SHALL be interpreted as the last day of the noted month including any adjustment for leap years (e.g., "130200" is "2013 February 28", "160200" is "2016 February 29", etc.).

- ✔ **Note:** This element string can only specify dates ranging from 49 years in the past to 50 years in the future. Determination of the correct century is explained in section [7.12](#).

Figure 3.4.5-1. Format of the element string

GS1 Application Identifier	Best before date		
	Year	Month	Day
1 5	N ₁ N ₂	N ₃ N ₄	N ₅ N ₆

The data transmitted from the barcode reader means that the element string denoting a best before date has been captured. As this element string is an attribute of a trade item, it must be processed together with the GTIN of the trade item to which it relates (see section [4.13 Data relationships](#)).

When indicating this element string in the non-HRI text section of a barcode label, the following data title SHOULD be used: **BEST BEFORE** or **BEST BY**

3.4.6 Sell by date: AI (16)

The GS1 Application Identifier (16) indicates the date specified by the manufacturer as the last date the retailer is to offer the product for sale to the consumer. The product should not be merchandised after this date.

 **Note:** This AI is to be used in sectors where the manufacturer has agreed to apply the SELL BY date for the customer’s use.

The structure is:

- Year: the tens and units of the year (e.g., 2003 = 03), which is mandatory.
- Month: the number of the month (e.g., January = 01), which is mandatory.
- Day: the number of the day of the relevant month (e.g., second day = 02); if it is not necessary to specify the day, the field must be filled with two zeroes.

 **Note:** When it is not necessary to specify the day (the Day field is filled with two zeroes), the resultant data string SHALL be interpreted as the last day of the noted month including any adjustment for leap years (e.g., “130200” is “2013 February 28”, “160200” is “2016 February 29”, etc.).

 **Note:** This element string can only specify dates ranging from 49 years in the past to 50 years in the future. Determination of the correct century is explained in section [7.12](#).

Figure 3.4.6-1. Format of the element string

GS1 Application Identifier	Sell by date		
	Year	Month	Day
1 6	N ₁ N ₂	N ₃ N ₄	N ₅ N ₆

The data transmitted from the barcode reader means that the element string denoting a sell by date has been captured. As this element string is an attribute of a trade item, it must be processed together with the GTIN of the trade item to which it relates (see section [4.13 Data relationships](#)).

When indicating this element string in the non-HRI text section of a barcode label, the following data title SHOULD be used: **SELL BY**

3.4.7 Expiration date: AI (17)

The GS1 Application Identifier (17) indicates that the GS1 Application Identifier data fields contain an expiration date. The expiration date is the date that determines the limit of consumption or use of a product/coupon. Its meaning is determined based on the trade item context (e.g., for food, the date will indicate the possibility of a direct health risk resulting from use of the product after the date, for pharmaceutical products, it will indicate the possibility of an indirect health risk resulting from the ineffectiveness of the product after the date). It is often referred to as "use by date" or "maximum durability date."

The structure is:

- Year: the tens and units of the year (e.g., 2003 = 03), which is mandatory.
- Month: the number of the month (e.g., January = 01), which is mandatory.

- Day: the number of the day of the relevant month (e.g., second day = 02); if it is not necessary to specify the day, the field must be filled with two zeroes.
- ✔ **Note:** When it is not necessary to specify the day (the day field is filled with two zeroes), the resultant data string SHALL be interpreted as the last day of the noted month including any adjustment for leap years (e.g., "130200" is "2013 February 28", "160200" is "2016 February 29", etc.).
- ✔ **Note:** How the day of the month is expressed for regulated healthcare products will change starting 1 January 2025. As of that date the day of the month SHALL NOT be expressed as two zeroes. A valid day of the month (e.g., last day of July = 31) SHALL be included.
- ✔ **Note:** This element string can only specify dates ranging from 49 years in the past to 50 years in the future. Determination of the correct century is explained in section [7.12](#).

Figure 3.4.7-1. Format of the element string

GS1 Application Identifier	Expiration date		
	Year	Month	Day
1 7	N ₁ N ₂	N ₃ N ₄	N ₅ N ₆

The data transmitted from the barcode reader means that the element string denoting an expiration date has been captured. As this element string is an attribute of a trade item or a coupon, it must be processed together with the GTIN or the GCN to which it relates (see section [4.13 Data relationships](#)).

When indicating this element string in the non-HRI text section of a barcode label, the following data title SHOULD be used: **USE BY or EXPIRY**

3.5 GS1 Application Identifiers starting with digit 2

3.5.1 Internal product variant: AI (20)

This element string may be used to distinguish an internal product variant from the usual item if the variation is not sufficiently significant to require a separate Global Trade Item Number (GTIN) and the variation is relevant only to the brand owner and any third party acting on its behalf.

The internal product variant is only for use by the brand owner and any third party acting on its behalf and not for dealings with any other trading partners. The product variant SHALL NOT be used where the variation would trigger the allocation of a different GTIN per the [GTIN Management Standard](#).

Although the element string will not have meaning to all trading partners, the element string may remain on the item throughout distribution.

Figure 3.5.1-1. Format of the element string

GS1 Application Identifier	Internal product variant
2 0	N ₁ N ₂

The GS1 Application Identifier (20) indicates that the data field contains an internal product variant number.

The internal product variant number must only be assigned by the brand owner. It forms a subsidiary numbering facility that can be used in addition to the item's GTIN and allows the creation of 100 variants of a particular item.

The data transmitted from the barcode reader means that the element string denoting an internal product variant has been captured. The internal product variant must be processed together with

the GTIN of the trade item (see section [4.13 Data relationships](#)). When indicating this element string in the non-HRI text section of a barcode label, the following data title SHOULD be used: **VARIANT**

3.5.2 Serial number: AI (21)

The GS1 Application Identifier (21) indicates that the GS1 Application Identifier data field contains a serial number. A serial number is assigned to an entity for its lifetime. When combined with a GTIN, a serial number uniquely identifies an individual item. The serial number field is alphanumeric and may include all characters contained in figure [7.11-1](#). The brand owner and the manufacturer are responsible for ensuring the non-duplication of serial numbers for a GTIN. For the re-use of serial numbers with a GTIN, sector-specific constraints need to be considered.

Figure 3.5.2-1. Format of the element string

GS1 Application Identifier	Serial number
2 1	X ₁ ————— variable length —————> X ₂₀

The data transmitted from the barcode reader means that the element string denoting a serial number has been captured. As this element string is an attribute of a trade item, it must be processed together with the GTIN of the trade item to which it relates (see section [4.13 Data relationships](#)).

When indicating this element string in the non-HRI text section of a barcode label, the following data title SHOULD be used: **SERIAL**

3.5.3 Consumer product variant: AI (22)

This element string may be used to distinguish one variant of a retail consumer trade item from another if the change does not require the allocation of a different Global Trade Item Number (per the [GTIN Management Standard](#)), but communication between trading partners is required to support consumers. The brand owner is responsible for assigning the consumer product variant. The data is alphanumeric and may include all characters contained in figure [7.11-1](#).

Figure 3.5.3-1. Format of the element string

GS1 Application Identifier	Consumer product variant
2 2	X ₁ ————— variable length —————> X ₂₀

The GS1 Application Identifier (22) indicates that the data field contains a consumer product variant.

 **Note:** The consumer product variant, AI (22), differs from the internal product variant, element string AI (20), which is relevant only to the brand owner and any third party acting on its behalf.

The data transmitted from the barcode reader means that the element string denoting a consumer product variant has been captured. The consumer product variant must be processed together with the GTIN of the trade item (see section [4.13 Data relationships](#)).

When indicating this element string in the non-HRI text section of a barcode label, the following data title SHOULD be used: **CPV**

3.5.4 Third Party Controlled, Serialised Extension of Global Trade Item Number (GTIN) (TPX): AI (235)

The GS1 Application Identifier (235) indicates that the GS1 Application Identifier data field contains a Third Party Controlled, Serialised Extension of GTIN (TPX).

This identifier is assigned to an entity for its lifetime. When combined with a GTIN, a TPX uniquely identifies an individual item and forms a unit pack Unique Identifier (upUI) for tobacco traceability

per EU 2018/574. The serial number field is alphanumeric and may include all characters contained in figure 7.11-1. The Third Party determines the TPX, but the TPX shall begin with the ID Issuer Unique Identification Code (UIC), followed by GS1 UIC Extension 1 and GS1 UIC Extension 2.

- The UIC begins with one numeric digit followed by one alphanumeric character from figure 7.11-1, GS1 AI encodable character set 82.
- The GS1 UIC Extension 1 is one alphanumeric character from figure 7.11-1, GS1 AI encodable character set 82.
- The GS1 UIC Extension 2 is one alphanumeric character from figure 7.11-1, GS1 AI encodable character set 82 For users of the GS1 algorithm, the characters 0-9, A-Z and a-e SHALL be used for GS1 UIC Extension 2. For users of a non-GS1 algorithm, characters f-z and special characters SHALL be used.

When encoded in a GS1 barcode the TPX SHALL be encoded before the GTIN.

 **Note:** Use of a Manufacturer’s Serial Number, AI (21), SHALL be the default choice in all trade item application standards, unless otherwise specified within an application standard. Third Party Controlled, Serialised Extension of GTIN (required by regulation) SHALL NOT be used in conjunction with a Manufacturer’s Serial Number.

Figure 3.5.4-1. Format of the element string

GS1 Application Identifier	Third Party Controlled, Serialised Extension of GTIN
235	X ₁ —————variable length—————> X ₂₈

The data transmitted from the barcode reader means that the element string denoting a Third Party Controlled, Serialised Extension of GTIN has been captured. As this element string is an attribute of a trade item, it must be processed together with the GTIN of the trade item to which it relates (see section 4.13 *Data relationships*).

When indicating this element string in the non-HRI text section of a barcode label, this element string in the non-HRI text section of a barcode label, the following data title SHOULD be used: **TPX**

3.5.5 Additional product identification assigned by the manufacturer: AI (240)

The GS1 Application Identifier (240) indicates that the GS1 Application Identifier data field contains additional item identification. The purpose of this element string is to enable identification data other than the Global Trade Item Number (GTIN) to be represented in a GS1 system data carrier. It is a cross-reference to previously used catalogue numbers. The additional item identification is considered an attribute of the GTIN (e.g., it facilitates migration to the GS1 system during a transitional period). However, it must not be used to replace the GTIN.

The additional item identification field is alphanumeric and may include all characters contained in figure 7.11-1. Its content and structure are at the discretion of the company applying the element string.

Figure 3.5.5-1. Format of the element string

GS1 Application Identifier	Additional item identification
2 4 0	X ₁ —————variable length—————> X ₃₀

The data transmitted from the barcode reader means that the element string denoting an additional item identification has been captured. This element string must be processed together with the GTIN of the trade item (see section 4.13 *Data relationships*).

When indicating this element string in the non-HRI text section of a barcode label, the following data title SHOULD be used: **ADDITIONAL ID**

3.5.6 Customer part number: AI (241)

The GS1 Application Identifier (241) indicates that the GS1 Application Identifier data field contains a customer part number. The purpose of this element string is to enable identification data other than the Global Trade Item Number (GTIN) to be represented in a GS1 system data carrier. The element string SHOULD only be used between trading partners that are currently using the customer part number for ordering and who have agreed on a timetable to convert to the GTIN for their business purposes. Therefore, the use of the GTIN and the AI (241) on trade items is for transitional use during the conversion. The customer part number must not be used in place of the GTIN. The customer part number field is alphanumeric and may include all characters contained in figure [7.11-1](#).

Figure 3.5.6-1. Format of the element string

GS1 Application Identifier	Customer part number
2 4 1	X ₁ ————— variable length —————>X ₃₀

The data transmitted from the barcode reader means that the element string denoting a customer part number has been captured. This element string must be processed together with the GTIN of the trade item (see section [4.13 Data relationships](#)). When indicating this element string in the non-HRI text section of a barcode label, the following data title SHOULD be used: **CUST. PART No.**

3.5.7 Made-to-Order variation number: AI (242)

The GS1 Application Identifier (242) indicates that the data field contains a Made-to-Order variation number. The data is variable length numeric up to and including six digits.

The Made-to-Order variation number provides the additional data needed to uniquely identify a custom trade item (see section [2.6.8](#)).

There is a mandatory association of AI (242) with a GTIN-14, indicator digit 9. This association indicates that the GTIN-14, indicator digit 9 represents a custom trade item when paired with AI (242).

A Made-to-Order variation number may not be used with the following GTINs: GTIN-8, GTIN-12, GTIN-13 and GTIN-14 indicator digit 1 through 8. The use of a GTIN-14, indicator digit 9 and a Made-to-Order variation number is only approved for the manufacturing and maintenance, repair & overhaul (MRO) environment.

Figure 3.5.7-1. Format of the element string

GS1 Application Identifier	Made-to-Order variation number
2 4 2	N ₁ ————— variable length —————> N ₆

The data transmitted by the barcode reader means that the element string denoting a Made-to-Order variation number has been captured. This element string must be processed together with the GTIN of the trade item to which it relates (see section [4.13 Data relationships](#)). When indicating this element string in the non-HRI text section of a barcode label, the following data title SHOULD also be used: **MTO VARIANT**

3.5.8 Packaging component number: AI (243)

The GS1 Application Identifier (243) indicates the GS1 Application Identifier data field contains a Packaging Component Number (PCN). A PCN is assigned to the packaging component for its lifetime. When associated with a GTIN, a PCN uniquely identifies the relationship between a finished consumer trade item and one of its packaging components.

The current use case for PCN is for internal use only however the PCN may be considered in future use cases for open supply chain applications. The Packaging Component Number field is alphanumeric and may include all characters contained in figure [7.11-1](#).

Figure 3.5.8-1. Format of the element string

GS1 Application Identifier	Packaging Component Number
2 4 3	X ₁ —————> variable length—————> X ₂₀

The data transmitted from the barcode reader means that the element string denoting a Packaging Component Number has been captured. As this element string is an attribute of a particular item, it must be processed together with the GTIN of the trade item to which it relates (see section [4.13.2](#)).

When indicating this element string in the non-HRI text section of a barcode label, the following data title SHOULD be used: **PCN**

3.5.9 Secondary serial number: AI (250)

The GS1 Application Identifier (250) indicates that the GS1 Application Identifier data field contains a secondary serial number. While the element string using AI (21) (see section [3.5.2](#)) contains the serial number of the trade item, the element string denoting a secondary serial number represents the serial number of a component of that item. The company applying the element string determines which component the element string refers to for a given trade item. The recognition of the meaning of the secondary serial number is accomplished via the GTIN and information provided by the issuer regarding the component to which the secondary serial number refers.

If this element string is being used, the trade item must be symbol marked with the following element strings:

- AI (01): representing the GTIN of the trade item.
- AI (21): representing the serial number of the trade item.
- AI (250): representing the serial number of a component of the trade item.

Only one element string with AI (250) may be associated with a particular GTIN.

The secondary serial number field is alphanumeric and may include all characters contained in figure [7.11-1](#). The number and to what component it relates is determined by the issuer.

Figure 3.5.9-1. Format of the element string

GS1 Application Identifier	Secondary serial number
2 5 0	X ₁ ————— variable length—————>X ₃₀

The data transmitted from the barcode reader means that the element string denoting a secondary serial number has been captured. This element string must be processed together with the GTIN and the serial number of the trade item (see section [4.13.2](#)). When indicating this element string in the non-HRI text section of a barcode label, the following data title SHOULD be used: **SECONDARY SERIAL**

3.5.10 Reference to source entity: AI (251)

The GS1 Application Identifier (251) indicates that the GS1 Application Identifier data field consists of a reference to the original item. Reference to source entity is an attribute of a trade item used to refer to the original item from which the trade item was derived. The issuer of the trade item must indicate through other means the source entity to which the data refers.

For example, the original item could be an animal from which a carcass of beef is derived. This element string would enable reference to the original animal, so that, if the animal was found to be contaminated, all derived products could be isolated. In addition, this element string could also be used for regulatory compliance when recycling parts from various white goods, such as refrigerators, where it is necessary to refer to the original appliance. The reference to the source entity field is alphanumeric and may include all characters contained in figure [7.11-1](#).

Figure 3.5.10-1. Format of the element string

GS1 Application Identifier	Reference to source entity
2 5 1	X ₁ ————variable length————>X ₃₀

The data transmitted by the barcode reader means that the element string denoting a reference to source entity has been captured. As this element string is an attribute of a trade item, it must be processed together with the GTIN of the trade item to which it relates (see section [4.13 Data relationships](#)).

When indicating this element string in the non-HRI text section of a barcode label, the following data title SHOULD be used: **REF. TO SOURCE**

3.5.11 Global Document Type Identifier (GDTI): AI (253)

The GS1 Application Identifier (253) indicates that the GS1 Application Identifier data field contains the Global Document Type Identifier (GDTI). The GDTI is used to identify a document type with an optional serial number.

The GS1 Company Prefix is allocated by GS1 Member Organisations to the company that allocates the GDTI – here the document issuer (see section [1.4.4](#)). It makes the number unique worldwide.

The structure and content of the Document Type is at the discretion of the document issuer, in order to uniquely identify each type of document.

The check digit is explained in section [7.9](#). Its verification, which must be carried out in the application software, ensures that the number is correctly composed.

The optional serial component is assigned to a single document for its lifetime. When the serial component is included, the GDTI uniquely identifies an individual document. The serial component field is alpha-numeric and may contain up to 17 characters. It may contain all characters contained in figure [7.11-1](#). The issuer of the document determines the serial component.

Figure 3.5.11-1. Format of the element string

GS1 Application Identifier	Global Document Type Identifier (GDTI)			
	GS1 Company Prefix —————>	Document type <—————	Check digit	Serial component (optional) —————>
2 5 3	N ₁ N ₂ N ₃ N ₄ N ₅ N ₆ N ₇ N ₈ N ₉ N ₁₀ N ₁₁ N ₁₂		N ₁₃	X ₁ ————variable————> X ₁₇

The data transmitted from the barcode reader means that the element string denoting a GDTI has been captured. When indicating this element string in the non-HRI text section of a barcode label, the following data title SHOULD be used: **GDTI**

3.5.12 Global Location Number (GLN) extension component: AI (254)

The GS1 Application Identifier (254) indicates that the data field contains an extension component of a Global Location Number (GLN). The use of AI (254) is optional, but when used it must appear in conjunction with AI (414), identification of a physical location.

The party who defined the location determines the extension component. Once determined, it is unchanged for the life of the associated GLN. The GLN extension component field is alphanumeric and may include all characters contained in figure [7.11-1](#).

Figure 3.5.12-1. Format of the element string

GS1 Application Identifier	GLN extension component
2 5 4	X ₁ ———— variable length —————> X ₂₀

The data transmitted from the reader means that the element string denoting an extension component of a GLN has been captured. As this element string is an attribute of a physical location, it must be processed together with the GLN to which it relates (see section [4.13 Data relationships](#)).

When indicating this element string in the non-HRI text section of a barcode label, the following data title SHOULD be used: **GLN EXTENSION COMPONENT**

3.5.13 Global Coupon Number (GCN): AI (255)

The GS1 Application Identifier (255) indicates that the GS1 Application Identifier data field contains the Global Coupon Number (GCN). The GCN provides a globally unique identification for a coupon, with an optional serial number.

The GS1 Company Prefix is allocated by GS1 Member Organisations to the company that allocates the GCN. It makes the number unique worldwide.

The structure and content of the coupon reference is at the discretion of the coupon issuer, in order to uniquely identify each type of coupon.

The check digit is explained in section 7.9. Its verification, which must be carried out in the application software, ensures that the number is correctly composed.

The optional serial component is assigned to an individual instance of a coupon. The combination of GS1 Company Prefix, coupon reference and serial component uniquely identifies an individual coupon. The serial component field is numeric and may contain up to 12 digits. The issuer of the Global Coupon Number determines the serial component.

Figure 3.5.13-1. Format of the element string

GS1 Application Identifier	Global Coupon Number (GCN)			
	GS1 Company Prefix	Coupon reference	Check digit	Serial component (optional)
2 5 5	N ₁ N ₂ N ₃ N ₄ N ₅ N ₆ N ₇ N ₈ N ₉ N ₁₀ N ₁₁ N ₁₂		N ₁₃	N ₁ —variable—> N ₁₂

When indicating this element string in the non-HRI text section of a barcode label, the following data title SHOULD be used: **GCN**

3.6 GS1 Application Identifiers starting with digit 3

3.6.1 Variable count of items: AI (30)

The GS1 Application Identifier (30) indicates that the GS1 Application Identifier data field contains the number of items contained in a variable measure trade item. This element string is used to complete the identification of a variable measure trade item and, therefore, should never be applied in isolation.

The variable count of items field represents the quantity contained in the respective trade item. It is of variable length and may have up to eight digits.

- 
Note: This element string must not be used to indicate the contained quantity of a fixed measure trade item. However, if this element string appears on a fixed measure trade item (in error) it should not invalidate the item identification but should be treated as redundant data.

Figure 3.6.1-1. Format of the element string

GS1 Application Identifier	Variable count of items
3 0	N ₁ — variable length —> N ₈

The data transmitted from the barcode reader means that the element string denoting a quantity (variable count of items), which can be considered part of the identification of a variable measure trade item, has been captured. This element string must be processed with the GTIN of the trade item to which it relates (see section 4.13 *Data relationships*).

When indicating this element string in the non-HRI text section of a barcode label, the following data title SHOULD be used: **VAR. COUNT**

3.6.2 Trade measures: AIs (31nn, 32nn, 35nn, 36nn)

The GS1 Application Identifiers (digits A1 to A4 – see figure below) indicate that the GS1 Application Identifier data field contains the quantity or dimension of a variable measure trade item. It also denotes the unit of measure. These element strings are used to complete the identification of a variable measure trade item. They contain information such as the weight, size, volume, or dimension of a variable measure trade item and, therefore, should never be applied alone. Several element strings are possible if the variables required are dimensions or weights expressed in kilograms and pounds.

The GS1 Application Identifier digit A4 indicates the implied decimal point position, where, for example, the digit 0 means that there is no decimal point, and the digit 1 means that the decimal point is between N5 and N6. The “applicable value” field contains the variable measure that applies to the respective trade item.

Figure 3.6.2-1. Format of the element string

GS1 Application Identifier				Applicable value					
A ₁	A ₂	A ₃	A ₄	N ₁	N ₂	N ₃	N ₄	N ₅	N ₆

The GS1 Application Identifiers used with this element string are shown in the figure below.

 **Note:** Other values of AI (3nnn) specify gross measures and logistic measures.

Figure 3.6.2-2. GS1 Application Identifiers for trade measures

A ₁	A ₂	A ₃	A ₄	Trade measure	Unit of measure
3	1	0	n	Net weight	Kilograms
3	1	1	n	Length or first dimension	Metres
3	1	2	n	Width, diameter, or second dimension	Metres
3	1	3	n	Depth, thickness, height, or third dimension	Metres
3	1	4	n	Area	Square metres
3	1	5	n	Net volume	Litres
3	1	6	n	Net volume	Cubic metres
3	2	0	n	Net weight	Pounds
3	2	1	n	Length or first dimension	Inches
3	2	2	n	Length or first dimension	Feet
3	2	3	n	Length or first dimension	Yards
3	2	4	n	Width, diameter, or second dimension	Inches
3	2	5	n	Width, diameter, or second dimension	Feet
3	2	6	n	Width, diameter, or second dimension	Yards
3	2	7	n	Depth, thickness, height, or third dimension	Inches
3	2	8	n	Depth, thickness, height, or third dimension	Feet
3	2	9	n	Depth, thickness, height, or third dimension	Yards
3	5	0	n	Area	Square inches
3	5	1	n	Area	Square feet
3	5	2	n	Area	Square yards
3	5	6	n	Net weight	Troy ounces
3	5	7	n	Net weight (or volume)	Ounces
3	6	0	n	Net volume	Quarts
3	6	1	n	Net volume	Gallons (U.S.)

A ₁	A ₂	A ₃	A ₄	Trade measure	Unit of measure
3	6	4	n	Net volume	Cubic inches
3	6	5	n	Net volume	Cubic feet
3	6	6	n	Net volume	Cubic yards

The data transmitted from the barcode reader means that the element string denoting a quantity, which can be considered part of the identification of a variable measure trade item, has been captured. This element string must be processed together with the GTIN of the trade item to which it relates (see section 4.13 *Data relationships*). When indicating this element string in the non-HRI text section of a barcode label, the data title listed in section 3.2 SHOULD be used.

3.6.3 Logistic measures: AIs (33nn, 34nn, 35nn, 36nn)

 **Note:** For AI (337) refer to section 3.6.4

The GS1 Application Identifiers (A1 to A4 see figure below) indicate that the GS1 Application Identifier data field contains the logistic quantity or dimension of a logistic unit or a variable measure trade item. They also denote the unit of measure.

 **Note:** The GS1 system provides standards for logistic weights and measures in metric and other units of measure. In principle, a particular logistic measure SHOULD be applied in only one unit of measure on a given logistic unit. However, application of the same attribute in several units of measure does not impede the correct processing of the transmitted data.

The GS1 Application Identifier digit in field A4 indicates the implied decimal point position, where, for example, the digit 0 means that there is no decimal point, and the digit 1 means that the decimal point is between N5 and N6. The Applicable Value field represents the measures of the respective unit.

Figure 3.6.3-1. Format of the element string

GS1 Application Identifier				Applicable value					
A ₁	A ₂	A ₃	A ₄	N ₁	N ₂	N ₃	N ₄	N ₅	N ₆

The GS1 Application Identifiers used with this element string are shown in the figure below.

Figure 3.6.3-2. GS1 Application Identifiers for logistic measures

A ₁	A ₂	A ₃	A ₄	Definition of logistic measures	Unit of measure
3	3	0	n	Logistic weight	Kilograms
3	3	1	n	Length or first dimension	Metres
3	3	2	n	Width, diameter, or second dimension	Metres
3	3	3	n	Depth, thickness, height, or third dimension	Metres
3	3	4	n	Area	Square metres
3	3	5	n	Logistic volume	Litres
3	3	6	n	Logistic volume	Cubic metres
3	4	0	n	Logistic weight	Pounds
3	4	1	n	Length or first dimension	Inches
3	4	2	n	Length or first dimension	Feet
3	4	3	n	Length or first dimension	Yards
3	4	4	n	Width, diameter, or second dimension	Inches
3	4	5	n	Width, diameter, or second dimension	Feet
3	4	6	n	Width, diameter, or second dimension	Yards
3	4	7	n	Depth, thickness, height, or third dimension	Inches

A ₁	A ₂	A ₃	A ₄	Definition of logistic measures	Unit of measure
3	4	8	n	Depth, thickness, height, or third dimension	Feet
3	4	9	n	Depth, thickness, height, or third dimension	Yards
3	5	3	n	Area	Square inches
3	5	4	n	Area	Square feet
3	5	5	n	Area	Square yards
3	6	2	n	Logistic volume	Quarts
3	6	3	n	Logistic volume	Gallons (U.S.)
3	6	7	n	Logistic volume	Cubic inches
3	6	8	n	Logistic volume	Cubic feet
3	6	9	n	Logistic volume	Cubic yards

The data transmitted from the barcode reader means that the element string denoting a logistic measure has been captured. This element string must be processed with the SSCC of the logistic unit or the GTIN of the variable measure trade item to which it relates (see section 4.13 *Data relationships*). When indicating this element string in the non-HRI text section of a barcode label, the data title listed in section 3.2 SHOULD be used.

3.6.4 Kilograms per square metre: AI (337n)

The GS1 Application Identifier (337n) indicates that the GS1 Application Identifier data field contains the kilograms per square metre of a particular trade item.

The GS1 Application Identifier digit shown as “n” indicates the implied decimal point position, where, for example, the digit 0 means that there is no decimal point, and the digit 1 means that the decimal point is between N5 and N6.

The **kilograms per square metre** field contains the weight per area of the respective trade item. The unit of measure is kilograms.

Figure 3.6.4-1. Format of the element string

GS1 Application Identifier	Kilograms per square metre					
3 3 7 n	N ₁	N ₂	N ₃	N ₄	N ₅	N ₆

The data transmitted from the barcode reader means that the element string denoting kilograms per square metre has been captured. As this element string is an attribute of a trade item, it must be processed together with the GTIN of the trade item to which it relates (see section 4.13 *Data relationships*).

When indicating this element string in the non-HRI text section of a barcode label, the following data title SHOULD be used: **KG PER m²**

3.6.5 Count of trade items or trade item pieces contained in a logistic unit: AI (37)

The GS1 Application Identifier (37) indicates that the GS1 Application Identifier data field contains the number of trade items contained in a logistic unit. This element string is a mandatory completion of AI (02) or AI (8026) described in sections 3.3.3 and 3.9.17.

The count of items field contains the number of trade items or number of trade item pieces contained in the respective logistic unit. This information refers to the identification number of the contained items.

Figure 3.6.5-1. Format of the element string

GS1 Application Identifier	Count of items
3 7	N ₁ —variable length—> N ₈

The data transmitted from the barcode reader means that the element string denoting a number of trade items contained in a logistic unit has been captured. Restrictions apply to the use of AI (37) in combination with other AIs, see section [4.13 Data relationships](#).

When indicating this element string in the non-HRI text section of a barcode label, the following data title SHOULD be used: **COUNT**

3.6.6 Amount payable or coupon value - Single monetary area: AI (390n)

The GS1 Application Identifier (390n) indicates that the GS1 Application Identifier data field contains the amount payable of a payment slip or the coupon value.

The GS1 Application Identifier digit shown as "n" indicates the implied decimal point position, where the digit 0 means that there is no decimal point, and the digit 1 means that the decimal point is before the last position of the amount payable. See examples in figure below.

The applicable amount payable contains the sum to be paid with the respective payment slip (see section [2.6.6](#)) or the coupon value (see section [2.6.2](#)).

Figure 3.6.6-1. Format of the element string

GS1 Application Identifier	Applicable amount payable or coupon value
3 9 0 n	N ₁ —————variable length —————> N ₁₅

 **Note:** To aid unambiguous processing of payment slips, AI (391n), described in section [3.6.7](#), SHOULD be used to indicate the currency in which the amount is expressed.

The figure below shows examples of the decimal point indication.

Figure 3.6.6-2. Decimal point indication examples

GS1 Application Identifier	Encoded value	Actual value
3 9 0 2	1 2 3 4 5 6 7	1 2 3 4 5 . 6 7
3 9 0 1	1 2 3 4 5 6 7	1 2 3 4 5 6 . 7 0
3 9 0 0	1 2 3 4 5	1 2 3 4 5 . 0 0

The data string transmitted from the barcode reader means that the element string denoting the amount payable of a payment slip or the coupon value has been captured. Restrictions apply to the use of AI (390n) in combination with other AIs, see section [4.13 Data relationships](#).

When indicating this element string in the non-HRI text section of a barcode label, the following data title SHOULD be used: **AMOUNT**

3.6.7 Amount payable and ISO currency code: AI (391n)

The GS1 Application Identifier (391n) indicates that the GS1 Application Identifier data fields consist of an ISO currency code and an applicable amount payable.

The GS1 Application Identifier digit shown as "n" indicates the implied decimal point position in the applicable amount payable field, where the digit 0 means that there is no decimal point, and the digit 1 means that the decimal point is before the last position of the amount payable. See examples in the figure below.

The ISO currency code field contains the three-digit currency number of the numerical international standard *ISO 4217* and indicates the currency in which the amount payable is expressed. The applicable amount payable contains the sum to be paid with the respective payment slip (see section [2.6.6](#)).

Figure 3.6.7-1. Format of the element string

GS1 Application Identifier	ISO currency code	Applicable amount payable
3 9 1 n	N ₁ N ₂ N ₃	N ₄ ——variable length ——>N ₁₈

Figure 3.6.7-2 shows examples of the decimal point indication.

Figure 3.6.7-2. Decimal point indication examples

GS1 Application Identifier	ISO currency code	Encoded value	Actual value
3 9 1 2	7 1 0*	1 2 3 0	1 2 . 3 0
3 9 1 1	7 1 0*	1 2 3 0	1 2 3 . 0 0
3 9 1 0	9 7 8**	1 2 3	1 2 3 . 0 0
* South African Rand		** Euro	

The data string transmitted from the barcode reader means that the element string denoting the amount payable has been captured. Restrictions apply to the use of AI (391n) in combination with other AIs, see section 4.13 *Data relationships*.

When indicating this element string in the non-HRI text section of a barcode label, the following data title SHOULD be used: **AMOUNT**

3.6.8 Amount payable for a variable measure trade item – Single monetary area: AI (392n)

The GS1 Application Identifier (392n) indicates that the GS1 Application Identifier data field contains the amount payable for a variable measure trade item.

The amount payable refers to an item identified by the Global Trade Item Number (GTIN) of a variable measure trade item and is expressed in local currency. This AI is an attribute of the GTIN and is always used in conjunction with it.

The GS1 Application Identifier digit shown as “n” indicates the implied decimal point position, where the digit 0 means that there is no decimal point, and the digit 1 means that the decimal point is before the last position of the amount payable. See examples in the figure below.

The applicable amount payable field contains the total to be paid for the variable measure trade item.

Figure 3.6.8-1. Format of the element string

GS1 Application Identifier	Applicable amount payable
3 9 2 n	N ₁ ——variable length ——>N ₁₅

Figure 3.6.8-2. Decimal point indication examples

GS1 Application Identifier	Encoded value	Actual value
3 9 2 2	1 2 3 4 5 6 7	1 2 3 4 5 . 6 7
3 9 2 1	1 2 3 4 5 6 7	1 2 3 4 5 6 . 7 0
3 9 2 0	1 2 3 4 5	1 2 3 4 5 . 0 0

The data transmitted by the barcode reader means that the element string denoting the amount payable of a variable measure trade item has been captured. As this element string is an attribute of a trade item, it must be processed together with the GTIN of the trade item to which it relates (see section 4.13 *Data relationships*). When indicating this element string in the non-HRI text section of a barcode label, the following data title SHOULD be used: **PRICE**

3.6.9 Amount payable for a variable measure trade item and ISO currency code: AI (393n)

The GS1 Application Identifier (393n) indicates that the GS1 Application Identifier data field consists of an ISO currency code and an applicable amount payable. The amount payable refers to an item identified with the Global Trade Item Number (GTIN) of a variable measure trade item and is expressed in the indicated currency. This AI is an attribute of the GTIN and is always expressed in conjunction with it.

The GS1 Application Identifier digit shown as “n” indicates the implied decimal point in the applicable amount payable Field, where the digit 0 means that there is no decimal point, and the digit 1 means that the decimal point is before the last position of the amount payable. See examples in the figure below.

The ISO currency code field contains the three-digit currency number of the numerical international standard *ISO/IEC 4217* and indicates the currency in which the amount payable is expressed. The applicable amount payable field contains the sum to be paid for the variable measure trade item.

Figure 3.6.9-1. Format of the element string

GS1 Application Identifier	ISO currency code	Applicable amount payable
3 9 3 n	N ₁ N ₂ N ₃	N ₄ ——variable length——>N ₁₈

Figure 3.6.9-2. Decimal point indication examples

GS1 Application Identifier	ISO currency code	Encoded value	Actual value
3 9 3 2	7 1 0*	1 2 3 0	1 2 . 3 0
3 9 3 1	7 1 0*	1 2 3 0	1 2 3 . 0 0
3 9 3 0	9 7 8**	1 2 3	1 2 3 . 0 0
* South African Rand		** Euro	

The data transmitted by the barcode reader means that the element string denoting the amount payable of a variable measure trade item has been captured. As this element string is an attribute of a trade item, it must be processed together with the GTIN of the trade item to which it relates (see section [4.13 Data relationships](#)). When indicating this element string in the non-HRI text section of a barcode label, the following data title SHOULD be used: **PRICE**

3.6.10 Percentage discount of a coupon: AI (394n)

The GS1 Application Identifier (394n) indicates that the GS1 Application Identifier data field contains the percentage discount of a coupon.

The GS1 Application Identifier digit shown as “n” indicates the implied decimal point position, where the digit 0 means that there is no decimal point, and the digit 1 means that the decimal point is before the last position of the amount payable. See examples in figure below.

Figure 3.6.10-1. Format of the element string

GS1 Application Identifier	Percentage discount of a coupon
3 9 4 n	N ₁ N ₂ N ₃ N ₄

The data string transmitted from the barcode reader means that the element string denoting the percentage to be taken off the purchase amount has been captured. The purchase amount on which the percentage discount would be granted depends on the conditions of the promotion (can be the purchase value of one item, can be the purchase value of a bundle of items or can even be on the total purchase value).

The figure below shows examples of the decimal point indication.

Figure 3.6.10-2. Decimal point indication examples

GS1 Application Identifier	Encoded value	Actual value
3 9 4 0	0 0 1 0	10 %
3 9 4 1	0 0 5 5	5.5 %

This element string must be processed together with the Global Coupon Number of the coupon to which it relates (see section [4.13 Data relationships](#)).

When indicating this element string in the non-HRI text section of a barcode label, the following data title SHOULD be used: **PRCNT OFF**

3.6.11 Amount payable per unit of measure single monetary area (variable measure trade item): AI (395n)

The GS1 Application Identifier (395n) indicates that the GS1 Application Identifier field contains the amount payable per unit of measure single monetary area (variable measure trade item).

The amount payable per unit of measure refers to an item identified by the Global Trade Item Number (GTIN) of a variable measure trade item and is expressed in local currency. This AI is an attribute of the GTIN and is always used in conjunction with it.

The GS1 Application Identifier digit shown as “n” indicates the implied decimal point position, where the digit 0 means that there is no decimal point and the digit 1 means that the decimal point is before the last position of the amount payable per unit of measure (single monetary area). See examples in figure below.

The Amount payable per unit of measure single monetary area field contains the price per unit of measure to be paid for the variable measure trade item.

Figure 3.6.11-1. Format of the element string

GS1 Application Identifier	Amount payable per unit of measure single monetary area (variable measure trade item)
3 9 5 n	N ₁ N ₂ N ₃ N ₄ N ₅ N ₆

The figure below shows examples of the decimal point indication.

Figure 3.6.11-2. Format of the element string

GS1 Application Identifier	Encoded value	Actual value
3953	123456	123.456
3952	123456	1234.56
3951	123456	12345.60
3950	123456	123456

The data transmitted from the barcode reader means that the element string denoting the amount payable per unit of measure (single monetary area) has been captured. As this element string is an attribute of a trade item, it must be processed together with the GTIN of the trade item to which it relates. Restrictions apply to the use of AI (395n) in combination with other AIs, (see section [4.13 Data relationships](#)). When indicating this element string in the non-HRI text section of a barcode label, the following data title SHOULD be used: **PRICE/UoM**

3.7 GS1 Application Identifiers starting with digit 4

3.7.1 Customer’s purchase order number: AI (400)

The GS1 Application Identifier (400) indicates that the GS1 Application Identifier data field contains the customer's purchase order number, restricted for use between two trading partners.

The customer's purchase order number field is alphanumeric and may include all characters contained in figure 7.11-1. It contains the number of the purchase order assigned by the company that issued the order. The composition and content of the order number is left to the discretion of the customer. For example, the purchase order number may include release and line numbers.

Figure 3.7.1-1. Format of the element string

GS1 Application Identifier	Customer's purchase order number
4 0 0	X ₁ —————variable length—————>X ₃₀

The data transmitted by the barcode reader means that the element string denoting a customer's purchase order number has been captured. This element string may be processed as stand-alone information or in combination with the GS1 identification key to which it relates.

! **Important:** This element string must be removed from the unit before the unit leaves the premises of the customer.

When indicating this element string in the non-HRI text section of a barcode label, the following data title SHOULD be used: **ORDER NUMBER**

3.7.2 Global Identification Number for Consignment (GINC): AI (401)

The GS1 Application Identifier (401) indicates that the GS1 Application Identifier data field contains a Global Identification Number for Consignment (GINC). This number identifies a logical grouping of goods (one or more physical entities) that has been consigned to a freight forwarder and is intended to be transported as a whole. The consignment number must be allocated by a freight forwarder (or a carrier acting as a freight forwarder) or a consignor, but only if prior agreement of the freight forwarder is given. Typically AI (401) encodes a house waybill number.

According to the GS1 Logistics Interoperability Model (LIM)³ a freight forwarder is a party that arranges the carriage of goods, including connected services and/or associated formalities, on behalf of a shipper or consignee. A carrier is a party that undertakes the transportation of goods from one point to another. A consignor is the party that sends the goods. A consignee is the party that receives the goods.

The GS1 Company Prefix is allocated by GS1 Member Organisations to the company that allocates the GINC – here the carrier (see section 1.4.4). It makes the number unique worldwide.

The structure and content of the consignment reference is at the discretion of the carrier, in order to uniquely identify each consignment. It may contain all characters contained in figure 7.11-1.

Figure 3.7.2-1. Format of the element string

GS1 Application Identifier	Global Identification Number for Consignment (GINC)	
	GS1 Company Prefix	Consignment reference
4 0 1	N ₁ ... N _i	X _{i+1} ... variable length X _{j (j<=30)}

The data transmitted by the barcode reader means the element string denoting a GINC has been captured. This element string may be processed as stand-alone information or in combination with the SSCC.

When indicating this element string in the non-HRI text section of a barcode label, the following data title SHOULD be used: **GINC**

3.7.3 Global Shipment Identification Number (GSIN): AI (402)

The GS1 Application Identifier (402) indicates that the data field contains a Global Shipment Identification Number (GSIN).

³ <https://www.gs1.org/lim>

The Global Shipment Identification Number (GSIN) is a number assigned by a consignor (seller) of goods. It provides a globally unique number that identifies a logical grouping of logistic units for the purpose of a transport shipment from that consignor (seller) to the consignee (buyer). It identifies the logical grouping of one or several logistic units each identified with a separate SSCC and containing trade items as being part of a specific seller/buyer relationship and that travels under one despatch advice and/or Bill of Lading. It may be used by all parties in the transport chain as a communication reference, for example, in Electronic Data Interchange (EDI) messages where it can be used as a shipment reference and/or a consignor’s loading list. The GSIN fulfils the requirements of the UCR (Unique Consignment Reference) of the World Customs Organisation (WCO).

The GS1 Company Prefix is allocated by GS1 Member Organisations to the company that allocates the GSIN – here the shipper (sender) (see section 1.4.4). It makes the number unique worldwide.

The structure and content of the shipper reference is at the discretion of the shipper, in order to uniquely identify each shipment. It SHOULD be sequentially allocated.

The check digit is explained in section 7.9. Its verification, which must be carried out in the application software, ensures that the number is correctly composed.

Figure 3.7.3-1. Format of the element string

GS1 Application Identifier	Global Shipment Identification Number (GSIN)																Check digit
	GS1 Company Prefix										Shipper reference						
4 0 2	N ₁	N ₂	N ₃	N ₄	N ₅	N ₆	N ₇	N ₈	N ₉	N ₁₀	N ₁₁	N ₁₂	N ₁₃	N ₁₄	N ₁₅	N ₁₆	N ₁₇

The data transmitted by the barcode reader means that the element string denoting a GSIN has been captured. This element string may be processed as stand-alone information or in combination with the SSCC. When indicating this element string in the non-HRI text section of a barcode label, the following data title SHOULD be used: **GSIN**

3.7.4 Routing code: AI (403)

The GS1 Application Identifier (403) indicates that the GS1 Application Identifier data field contains a routing code. The routing code is assigned by the parcel carrier and is an attribute of the SSCC (Serial Shipping Container Code). It is intended to provide a migration path to the adoption of a yet-to-be-defined international, multi-modal solution. The routing code must not be used to encode information for which other element strings have been created (such as a ship to postal code).

The routing code field is alphanumeric and may include all characters contained in figure 7.11-1. Its content and structure are at the discretion of the parcel carrier issuing the code. If parcel carriers wish to enter co-operative agreements with other parcel carriers, then a mutually agreed indicator is required to designate the structure of the routing code.

Figure 3.7.4-1. Format of the element string

GS1 Application Identifier	Routing code
4 0 3	X ₁ —————variable length—————>X ₃₀

The data transmitted from the barcode reader means that the element string denoting a routing code has been captured. As this element string is an attribute of a logistic unit, it must be processed together with the SSCC to which it relates (see section 4.13 *Data relationships*). When indicating this element string in the non-HRI text section of a barcode label, the following data title SHOULD be used: **ROUTE**

 **Note:** This field may be used to encode the UPU S10 freight unit identifier within a GS1 symbol.

3.7.5 Ship to - Deliver to Global Location Number (GLN): AI (410)

The GS1 Application Identifier (410) indicates that the GS1 Application Identifier data field contains the Global Location Number (GLN) of the consignee.

The GS1 Company Prefix is allocated by GS1 Member Organisations to the company that allocates the GLN – here the addressee (see section 1.4.4). It makes the number unique worldwide.

The structure and content of the location reference is at the discretion of the party who defined the location, in order to uniquely identify each location.

The check digit is explained in section 7.9. Its verification, which must be carried out in the application software, ensures that the number is correctly composed.

Figure 3.7.5-1. Format of the element string

GS1 Application Identifier	GS1 Company Prefix	Location reference	Check digit
4 1 0	N ₁ N ₂ N ₃ N ₄ N ₅ N ₆ N ₇ N ₈ N ₉ N ₁₀ N ₁₁ N ₁₂		N ₁₃

The data transmitted from the barcode reader means that the element string denoting the GLN of the consignee of a physical item has been captured. This element string may be processed as stand-alone information or in combination with the GS1 identification key to which it relates. When indicating this element string in the non-HRI text section of a barcode label, the following data title SHOULD be used: **SHIP TO LOC**

3.7.6 Bill to - Invoice to Global Location Number (GLN): AI (411)

The GS1 Application Identifier (411) indicates that the GS1 Application Identifier data field contains the Global Location Number (GLN) of the addressee of an invoice.

The GS1 Company Prefix is allocated by GS1 Member Organisations to the company that allocates the GLN – here the addressee (see section 1.4.4). It makes the number unique worldwide.

The structure and content of the location reference is at the discretion of the party who defined the location, in order to uniquely identify each location.

The check digit is explained in section 7.9. Its verification, which must be carried out in the application software, ensures that the number is correctly composed.

Figure 3.7.6-1. Format of the element string

GS1 Application Identifier	GS1 Company Prefix	Location reference	Check digit
4 1 1	N ₁ N ₂ N ₃ N ₄ N ₅ N ₆ N ₇ N ₈ N ₉ N ₁₀ N ₁₁ N ₁₂		N ₁₃

The data transmitted from the barcode reader means that the element string denoting the GLN of the addressee of an invoice has been captured. This element string may be processed as stand-alone information or in combination with the GS1 identification key to which it relates. When indicating this element string in the non-HRI text section of a barcode label, the following data title SHOULD be used: **BILL TO**

3.7.7 Purchased from Global Location Number (GLN): AI (412)

The GS1 Application Identifier (412) indicates that the GS1 Application Identifier data field contains the Global Location Number (GLN) of the company from which the respective trade item has been purchased.

The GS1 Company Prefix is allocated by GS1 Member Organisations to the company that allocates the GLN – here the supplier (see section 1.4.4). It makes the number unique worldwide.

The structure and content of the location reference is at the discretion of the party who defined the location, in order to uniquely identify each location.

The check digit is explained in section 7.9. Its verification, which must be carried out in the application software, ensures that the number is correctly composed.

Figure 3.7.7-1. Format of the element string

GS1 Application Identifier	GS1 Company Prefix	Location reference	Check digit
4 1 2	N ₁ N ₂ N ₃ N ₄ N ₅ N ₆ N ₇ N ₈ N ₉ N ₁₀ N ₁₁ N ₁₂		N ₁₃

The data transmitted from the barcode reader means that the element string denoting the GLN of the company that supplied the trade item has been captured. This element string may be processed as stand-alone information or in combination with the GS1 identification key to which it relates.

When indicating this element string in the non-HRI text section of a barcode label the following data title SHOULD be used: **PURCHASE FROM**

3.7.8 Ship for - Deliver for - Forward to Global Location Number (GLN): AI (413)

The GS1 Application Identifier (413) indicates that the GS1 Application Identifier data field contains the Global Location Number (GLN) of the internal or subsequent final destination.

The GS1 Company Prefix is allocated by GS1 Member Organisations to the company that allocates the GLN – here the final recipient (see section 1.4.4). It makes the number unique worldwide.

The structure and content of the location reference is at the discretion of the party who defined the location, in order to uniquely identify each location.

The check digit is explained in section 7.9. Its verification, which must be carried out in the application software, ensures that the number is correctly composed.

Note: This element string is for the internal use of the consignee and is not to be used by the carrier.

Figure 3.7.8-1. Format of the element string

GS1 Application Identifier	GS1 Company Prefix	Location reference	Check digit
4 1 3	N ₁ N ₂ N ₃ N ₄ N ₅ N ₆ N ₇ N ₈ N ₉ N ₁₀ N ₁₁ N ₁₂		N ₁₃

The data transmitted from the barcode reader means that the element string denoting the GLN of the final recipient of a physical item has been captured. This element string may be processed as stand-alone information or in combination with the GS1 identification key to which it relates. When indicating this element string in the non-HRI text section of a barcode label, the following data title SHOULD be used: **SHIP FOR LOC**

3.7.9 Identification of a physical location - Global Location Number (GLN): AI (414)

The GS1 Application Identifier (414) indicates that the GS1 Application Identifier data field contains the Global Location Number (GLN) of a physical location (see section 2.4).

The GS1 Company Prefix is allocated by GS1 Member Organisations to the company that allocates the GLN – here the holder of the physical location (see section 1.4.4). It makes the number unique worldwide.

The structure and content of the location reference is at the discretion of the party who defined the location, in order to uniquely identify each location.

The check digit is explained in section 7.9. Its verification, which must be carried out in the application software, ensures that the number is correctly composed.

Figure 3.7.9-1. Format of the element string

GS1 Application Identifier	GS1 Company Prefix	Location reference	Check digit
4 1 4	N ₁ N ₂ N ₃ N ₄ N ₅ N ₆ N ₇ N ₈ N ₉ N ₁₀ N ₁₁ N ₁₂		N ₁₃

The data transmitted from the barcode reader means that the element string denoting the GLN of a physical location has been captured from the location itself. This element string may be processed as stand-alone information or in combination with the GS1 identification key to which it relates. When indicating this element string in the non-HRI text section of a barcode label, the following data title SHOULD be used: **LOC No.**

3.7.10 Global Location Number (GLN) of the invoicing party: AI (415)

The GS1 Application Identifier (415) indicates that the GS1 Application Identifier data field contains the Global Location Number (GLN) of the invoicing party.

The GS1 Company Prefix is allocated by GS1 Member Organisations to the company that allocates the GLN – here the invoicing party (see section 1.4.4). It makes the number unique worldwide.

The structure and content of the location reference is at the discretion of the party who defined the location, in order to uniquely identify each location.

The check digit is explained in section 7.9. Its verification, which must be carried out in the application software, ensures that the number is correctly composed.

 **Note:** This element string is mandatory on a payment slip. Together with the payment slip reference number, AI (8020), it uniquely identifies a payment slip.

Figure 3.7.10-1. Format of the element string

GS1 Application Identifier	GS1 Company Prefix	Location reference	Check digit
4 1 5	N ₁ N ₂ N ₃ N ₄ N ₅ N ₆ N ₇ N ₈ N ₉ N ₁₀ N ₁₁ N ₁₂		N ₁₃

The data transmitted from the barcode reader means that the element string denoting the GLN of the invoicing party has been captured. This element string must be processed together with the payment slip reference number to which it relates (see section 4.13 *Data relationships*). When indicating this element string in the non-HRI text section of a barcode label, the following data title SHOULD be used: **PAY TO**

3.7.11 Global Location Number (GLN) of the production or service location: AI (416)

The Application Identifier (416) indicates that the GS1 Application Identifier data field contains the Global Location Number (GLN) of the production or service location.

The GS1 Company Prefix is allocated by GS1 Member Organisations to the company that allocates the GLN (see section 1.4.4).

The structure and content of the location reference is at the discretion of the party that defined the location.

The check digit is explained in section 7.9. Its verification, which must be carried out in the application software, ensures that the number is correctly composed.

Figure 3.7.11-1. Format of the element string

GS1 Application Identifier	GS1 Company Prefix	Location reference	Check digit
4 1 6	N ₁ N ₂ N ₃ N ₄ N ₅ N ₆ N ₇ N ₈ N ₉ N ₁₀ N ₁₁ N ₁₂		N ₁₃

The data transmitted from the barcode reader means that the element string denoting the GLN of production or service location has been captured. This element string may be processed as stand-alone information or in combination with the GS1 identification key to which it relates. When indicating this element string in the non-HRI text section of a barcode label, the following data title SHOULD be used: **PROD/SERV LOC**

3.7.12 Party Global Location Number (GLN): AI (417)

The GS1 Application Identifier (417) indicates that the GS1 Application Identifier data field contains the Global Location Number (GLN) of a party. The GS1 Company Prefix (GCP) is allocated by GS1 Member Organisations to the company that allocates the GLN. The GCP makes the number unique worldwide. The structure and content of the party reference is at the discretion of the party in order to uniquely identify themselves.

The check digit is explained in section 7.9. Its verification, which must be carried out in the application software, ensures that the number is correctly composed.

Figure 3.7.12-1. Format of the element string

GS1 Application Identifier	GS1 Company Prefix	Location reference	Check digit
4 1 7	N ₁ N ₂ N ₃ N ₄ N ₅ N ₆ N ₇ N ₈ N ₉ N ₁₀ N ₁₁ N ₁₂		N ₁₃

The data transmitted from the barcode reader means that the element string denoting a Party GLN has been captured.

When indicating this element string in the non-HRI text section of a barcode label, this element string in the non-HRI text section of a barcode label, the following data title SHOULD be used: **PARTY**

3.7.13 Ship-to / Deliver-to postal code within a single postal authority: AI (420)

The GS1 Application Identifier (420) indicates that the GS1 Application Identifier data field contains the postal code of the addressee (national format). The postal code field contains the postal code of the addressee as defined by the appropriate postal authority. It is left justified and must not contain any fill characters.

Figure 3.7.13-1. Format of the element string

GS1 Application Identifier	Postal code
4 2 0	X ₁ —variable length—X ₂₀

The data transmitted from the barcode reader means that the element string denoting the national version of a postal code of the addressee of the transport unit has been captured. This element may be processed as stand-alone information or in combination with the GS1 identification key to which it relates. Restrictions apply to the use of AI (420) in combination with other AIs, see section 4.13 *Data relationships*. When indicating this element string in the non-HRI text section of a barcode label, the following data title SHOULD be used: **SHIP TO POST**

3.7.14 Ship-to / Deliver-to postal code with three-digit ISO country code: AI (421)

The GS1 Application Identifier (421) indicates that the GS1 Application Identifier data field contains the postal code of the addressee (international format). The ISO country code field contains the three-digit country number of the numerical international standard *ISO 3166*.

The national postal code field, which follows the three-digit ISO country code, contains the postal code of the addressee as defined by the appropriate postal authority. It is left justified and must not contain any fill characters.

Figure 3.7.14-1. Format of the element string

GS1 Application Identifier	ISO country code	Postal code
4 2 1	N ₁ N ₂ N ₃	X ₄ —variable length—X ₁₂

The data transmitted from the barcode reader means that the element string denoting the international version of a postal code of the addressee of the transport unit has been captured. This element string may be processed as stand-alone information or in combination with the GS1 identification key to which it relates. Restrictions apply to the use of AI (421) in combination with other AIs, see section 4.13 *Data relationships*.

When indicating this element string in the non-HRI text section of a barcode label, the following data title SHOULD be used: **SHIP TO POST**

3.7.15 Country of origin of a trade item: AI (422)

The GS1 Application Identifier (422) indicates that the GS1 Application Identifier data field contains the ISO country code of the country of origin of the trade item. The ISO country code field contains the three-digit country number of the numerical international standard *ISO 3166* that is the country of origin.

- ✔ **Note:** The country of origin is normally the country in which the trade item has been produced or manufactured. In meat supply chain applications AI (422) is used to indicate the country of birth of the animal. Due to a wide range of definitions for country of origin, which were created for different purposes, it is the manufacturer's responsibility to assign the correct country of origin.

Figure 3.7.15-1. Format of the element string

GS1 Application Identifier	ISO country code		
4 2 2	N ₁	N ₂	N ₃

The data transmitted from the barcode reader means that the element string denoting the ISO country code of the country of origin of the respective trade item has been captured. As this element string is an attribute of a trade item, it must be processed together with the GTIN of the trade item to which it relates. Restrictions apply to the use of AI (422) in combination with other AIs, see section [4.13 Data relationships](#).

When indicating this element string in the non-HRI text section of a barcode label, the following data title SHOULD be used: **ORIGIN**

3.7.16 Country of initial processing: AI (423)

The GS1 Application Identifier (423) indicates that the GS1 Application Identifier data field contains the ISO country code(s) of the country or countries of initial processing of the trade item.

The ISO country code field contains the three-digit country code(s) from the numerical international standard *ISO 3166* that indicates the country or countries of initial processing.

- ✔ **Note:** The country of initial processing is normally the country in which the trade item has been produced or manufactured. In meat supply chain applications AI (423) is used to indicate the country/countries of rearing and fattening of the animal. In certain applications, such as livestock fattening, the country of initial processing may include up to five different countries, all of which should be indicated. It is the responsibility of the supplier to allocate the correct country code(s).

Figure 3.7.16-1. Format of the element string

GS1 Application Identifier	ISO country code(s)				
4 2 3	N ₁	N ₂	N ₃ ...	N ₁₅	

The data transmitted from the barcode reader means that the element string denoting the ISO country code(s) of the country or countries of initial processing of the respective trade item has been captured. As this element string is an attribute of a trade item, it must be processed together with the GTIN of the trade item to which it relates. Restrictions apply to the use of AI (423) in combination with other AIs, see section [4.13 Data relationships](#).

When indicating this element string in the non-HRI text section of a barcode label, the following data title SHOULD be used: **COUNTRY – INITIAL PROCESS**

3.7.17 Country of processing: AI (424)

The GS1 Application Identifier (424) indicates that the GS1 Application Identifier data field contains the ISO country code of the country of processing of the trade item.

The ISO country code field contains the three-digit country code of the numerical international standard *ISO 3166* that is the country of processing.

- ✔ **Note:** It is the responsibility of the processor of the trade item to allocate the correct country code. In meat or fish supply chain applications AI (424) is used to indicate the country of slaughtering or processing.

Figure 3.7.17-1. Format of the element string

GS1 Application Identifier	ISO country code		
4 2 4	N ₁	N ₂	N ₃

The data transmitted from the barcode reader means that the element string denoting the ISO country code of the country of processing of the respective trade item has been captured. As this element string is an attribute of a trade item, it must be processed together with the GTIN of the trade item to which it relates. Restrictions apply to the use of AI (424) in combination with other AIs, see section [4.13 Data relationships](#).

When indicating this element string in the non-HRI text section of a barcode label, the following data title SHOULD be used: **COUNTRY – PROCESS**

3.7.18 Country of disassembly: AI (425)

The GS1 Application Identifier (425) indicates that the GS1 Application Identifier data field contains the ISO country code of the country or countries of disassembly of the trade item. The ISO country code field contains the three-digit country code(s) from the numerical international standard *ISO 3166* that indicates the country or countries of disassembly.

- ✔ **Note:** In meat supply chain applications AI (425) is used to indicate the country of deboning. In certain applications, such as meat or fish process chains, the process of disassembly is a multi-stage process and the country of disassembly may include several different countries, all of which should be indicated. It is the responsibility of the party doing the disassembly of the trade item to allocate the correct country code(s).

Figure 3.7.18-1. Format of the element string

GS1 Application Identifier	ISO country code			
4 2 5	N ₁	N ₂	N ₃ ...N ₁₅	

The data transmitted from the barcode reader means that the element string denoting the ISO country code(s) of the country or countries of disassembly of the respective trade item has been captured. As this element string is an attribute of a trade item, it must be processed together with the GTIN of the trade item to which it relates. Restrictions apply to the use of AI (425) in combination with other AIs, see section [4.13 Data relationships](#). When indicating this element string in the non-HRI text section of a barcode label, the following data title SHOULD be used: **COUNTRY – DISASSEMBLY**

3.7.19 Country covering full process chain: AI (426)

The GS1 Application Identifier (426) indicates that the GS1 Application Identifier data field contains the ISO country code of the country where all the processing of the trade item took place. The ISO country code field contains the three-digit country code of the numerical international standard *ISO 3166* that is the country of full processing.

- 
Note: If this AI is used, the full processing of a trade item must have taken place in a single country. This is particularly important in certain applications (e.g., covering a livestock animal’s birth, fattening and slaughter) where processing could take place in different countries. In situations like this, AI (426) may not be used. It is the responsibility of the supplier to allocate the correct country code.

Figure 3.7.19-1. Format of the element string

GS1 Application Identifier	ISO country code
4 2 6	N ₁ N ₂ N ₃

The data transmitted from the barcode reader means that the element string denoting the ISO country code of the country of full processing of the trade item has been captured. As this element string is an attribute of a trade item, it must be processed together with the GTIN of the trade item to which it relates. Restrictions apply to the use of AI (426) in combination with other AIs, see section [4.13 Data relationships](#).

When indicating this element string in the non-HRI text section of a barcode label, the following data title SHOULD be used: **COUNTRY – FULL PROCESS**

3.7.20 Country subdivision of origin code for a trade item: AI (427)

The GS1 Application Identifier (427) indicates that the GS1 Application Identifier data field contains the ISO based country subdivision code (e.g., provinces, states, cantons, etc.) of a country’s local region origin of the trade item. The ISO country subdivision code field contains up to three alphanumeric characters after separator of *ISO 3166-2* that is the principal subdivision of origin.



- 
Note: This GS1 AI is applicable to trade item groupings where the contents originate from only one region.
- 
Note: The local region of origin is the principal subdivision in which the trade item has been produced or manufactured. Determination of the principle subdivision is the brand owner’s responsibility.

Figure 3.7.20-1. Format of the element string

GS1 Application Identifier	ISO subdivision code
4 2 7	X ₁ ——variable length——> X ₃

The data transmitted from the barcode reader means that the element string denoting the ISO based country subdivision code of the trade item has been captured. This element string must be processed together with the GTIN of the trade item and the country of origin to which it relates (see section [4.13 Data relationships](#)). When indicating this element string in the non-HRI text section of a barcode label, the following data title SHOULD be used: **ORIGIN SUBDIVISION**

3.7.21 Ship-to / Deliver-to Company name: AI (4300)

The GS1 Application Identifier (4300) indicates that the GS1 Application Identifier data field contains the name of a company. The company name is the name of the organisation intended to receive the logistic unit.

Figure 3.7.21-1. Format of the element string

GS1 Application Identifier	Ship-to / Deliver-to Company
4 3 0 0	X ₁ ————> variable length —————>X ₃₅

The data transmitted from the barcode reader means that the element string denoting the ship-to / deliver-to company name has been captured. As a free text field for transport process information, non-Latin characters and a space character may be encoded, see section [2.6.15](#). As this element string is an attribute of a logistic unit, it must be processed together with the SSCC of the logistic unit to which it relates (see section [4.13 Data relationships](#)).

When indicating this element string in the non-HRI text section of a barcode label, the following data title SHOULD be used: **SHIP TO COMP**

3.7.22 Ship-to / Deliver-to contact name: AI (4301)

The GS1 Application Identifier (4301) indicates that the GS1 Application Identifier data field contains contact name for the ship-to address. This contact name is the name of the individual intended to receive the logistic unit.

Figure 3.7.22-1. Format of the element string

GS1 Application Identifier	Ship-to / Deliver-to Contact
4 3 0 1	X ₁ —————> variable length —————>X ₃₅

The data transmitted from the barcode reader means that the element string denoting the ship-to / deliver-to contact of a logistic unit has been captured. As a free text field for transport process information, non-Latin characters and a space character may be encoded, see section [2.6.15](#). As this element string is an attribute of a logistic unit, it must be processed together with the SSCC of the logistic unit to which it relates (see section [4.13 Data relationships](#)). When indicating this element string in the non-HRI text section of a barcode label, the following data title SHOULD be used: **SHIP TO NAME**

3.7.23 Ship-to / Deliver-to address line 1: AI (4302)

The GS1 Application Identifier (4302) indicates that the GS1 Application Identifier data field contains line one of the ship-to / deliver-to street address line 1 (e.g., street).

Figure 3.7.23-1. Format of the element string

GS1 Application Identifier	Ship-to / Deliver-to address line 1
4 3 0 2	X ₁ —————>variable length—————>X ₇₀

The data transmitted from the barcode reader means that the element string denoting ship-to / deliver-to address line 1 has been captured. As this element string is an attribute of a logistic unit, it must be processed together with the SSCC of the logistic unit to which it relates (see section [4.13 Data relationships](#)). As a free text field for transport process information, non-Latin characters and a space character may be encoded, see section [2.6.15](#). When indicating this element string in the non-HRI text section of a barcode label, the following data title SHOULD be used: **SHIP TO ADD1**

3.7.24 Ship-to / Deliver-to address line 2: AI (4303)

The GS1 Application Identifier (4303) indicates that the GS1 Application Identifier data field contains line two of the ship-to / deliver-to street address.

Figure 3.7.24-1. Format of the element string

GS1 Application Identifier	Ship-to / Deliver-to address line 2
4 3 0 3	X ₁ —————>variable length—————>X ₇₀

The data transmitted from the barcode reader means that the element string denoting line two of the ship-to / deliver-to address has been captured. This element string must be processed together with the Ship-to / Deliver-to address line 1, (see section [4.13 Data relationships](#)). Restrictions apply to the use of AI (4303) in combination with other AIs, see section [4.13 Data relationships](#). As a free text field for transport process information, non-Latin characters and a space character may be encoded, see section [2.6.15](#). When indicating this element string in the non-HRI text section of a barcode label, the following data title SHOULD be used: **SHIP TO ADD2**

3.7.25 Ship-to / Deliver-to suburb: AI (4304)

The GS1 Application Identifier (4304) indicates that the GS1 Application Identifier data field contains suburb information for the ship-to / deliver-to address.

Figure 3.7.25-1. Format of the element string

GS1 Application Identifier	Ship-to / Deliver-to suburb
4 3 0 4	X ₁ —————>variable length—————>X ₇₀

The data transmitted from the barcode reader means that the element string denoting the suburb for the ship to address has been captured. As this element string is an attribute of a logistic unit, it must be processed together with the SSCC of the logistic unit to which it relates (see section [4.13 Data relationships](#)).

As a free text field for transport process information, non-Latin characters and a space character may be encoded, see section [2.6.15](#). When indicating this element string in the non-HRI text section of a barcode label, the following data title SHOULD be used: **SHIP TO SUB**

3.7.26 Ship-to / Deliver-to locality: AI (4305)

The GS1 Application Identifier (4305) indicates that the GS1 Application Identifier data field contains locality information for the ship-to / deliver-to address. Locality typically means a town or city.

Figure 3.7.26-1. Format of the element string

GS1 Application Identifier	Ship-to / Deliver-to locality
4 3 0 5	X ₁ —————>variable length—————>X ₇₀

The data transmitted from the barcode reader means that the element string denoting the locality for the ship to / deliver-to address has been captured. As a free text field for transport process information, non-Latin characters and a space character may be encoded, see section [2.6.15](#). As this element string is an attribute of a logistic unit, it must be processed together with the SSCC of the logistic unit to which it relates (see section [4.13 Data relationships](#)).

When indicating this element string in the non-HRI text section of a barcode label, the following data title SHOULD be used: **SHIP TO LOC**

3.7.27 Ship-to / Deliver-to region: AI (4306)

The GS1 Application Identifier (4306) indicates that the GS1 Application Identifier data field contains the region information for the ship-to / deliver-to address. Region typically means a first-tier federal state within a country, such as a state in the USA or Australia or a county within the UK.

Figure 3.7.27-1. Format of the element string

GS1 Application Identifier	Ship-to / Deliver-to region
4 3 0 6	X ₁ —————>variable length—————>X ₇₀

The data transmitted from the barcode reader means that the element string denoting region or the ship to / deliver-to address has been captured. As a free text field for transport process information, non-Latin characters and a space character may be encoded, see section [2.6.15](#). As this element string is an attribute of a logistic unit, it must be processed together with the SSCC of the logistic unit to which it relates (see section [4.13 Data relationships](#)).

When indicating this element string in the non-HRI text section of a barcode label, the following data title SHOULD be used: **SHIP TO REG**

3.7.28 Ship-to / Deliver-to country code: AI (4307)

The GS1 Application Identifier (4307) indicates that the GS1 Application Identifier data field contains the country code for the ship-to / deliver-to address. Alpha-2 codes from ISO 3166 *Country Codes* SHALL be used, e.g., FR for France, DE for Germany.

Figure 3.7.28-1. Format of the element string

GS1 Application Identifier	Ship-to / Deliver-to country code
4 3 0 7	X ₁ X ₂

The data transmitted from the barcode reader means that the element string denoting the country code for ship-to / deliver-to country code has been captured. As this element string is an attribute of a logistic unit, it must be processed together with the SSCC of the logistic unit to which it relates (see section [4.13 Data relationships](#)).

When indicating this element string in the non-HRI text section of a barcode label, the following data title SHOULD be used: **SHIP TO COUNTRY**

3.7.29 Ship-to / Deliver-to telephone number: AI (4308)

The GS1 Application Identifier (4308) indicates that the GS1 Application Identifier data field contains the phone number associated with the ship-to / deliver-to address.

Figure 3.7.29-1. Format of the element string

GS1 Application Identifier	Ship-to / Deliver-to telephone number
4 3 0 8	X ₁ —————>variable length—————>X ₃₀

The data transmitted from the barcode reader means that the element string denoting the ship-to / deliver-to telephone number has been captured. As this element string is an attribute of a logistic unit, it must be processed together with the SSCC of the logistic unit to which it relates (see section [4.13 Data relationships](#)).

This AI permits up to 30 alphanumeric characters from the GS1 AI encodable character set 82, figure [7.11-1](#). It is recommended to specify a full International Direct Dial (IDD) phone number including country code, area code and subscriber number (and any extension if required). Note that a space character is not included in figure [7.11-1](#), so hyphen character may be used in place of space.

ITU standard E.164 format is an all-numeric format for IDD and assumes that the country code are the first digits; it contains no International Dialling Prefix.

For example, the IDD format of GS1 Global Office telephone number is +32-2-788-78-00. The E.164 format for the same example is 3227887800. Either format (IDD or E.164) (e.g., +32-2-788-78-00 or 3227887800) is acceptable for the value of this Application Identifier.

When indicating this element string in the non-HRI text section of a barcode label, the following data title SHOULD be used: **SHIP TO PHONE**

3.7.30 Ship-to / Deliver-to GEO location: AI (4309)

The Application Identifier (4309) indicates that the GS1 Application Identifier data field contains a numeric string that can be converted to geocoordinates for the ship-to/deliver-to location.

The geocoordinate conversion algorithms are explained in section [7.13](#) and [7.14](#). The conversions, which must be carried out in the application software, can provide a latitude and longitude from a twenty-digit string associated with the ship-to/deliver-to location, see section [7.14](#). The process for converting a latitude and longitude into a twenty-digit string is shown in section [7.13](#).

Figure 3.7.30-1. Format of the element string

GS1 Application Identifier	Ship-to / Deliver-to GEO location	
	<- digits for latitude conversion->	< -- digits for longitude conversion-->
4 3 0 9	N ₁ N ₂ N ₃ N ₄ N ₅ N ₆ N ₇ N ₈ N ₉ N ₁₀ N ₁₁ N ₁₂ N ₁₃ N ₁₄ N ₁₅ N ₁₆ N ₁₇ N ₁₈ N ₁₉ N ₂₀	

The data transmitted from the barcode reader means that the element string associated with the ship-to/deliver-to GEO location has been captured. As this element string is an attribute of a logistic unit, it must be processed together with the SSCC of the logistic unit to which it relates (see section [4.13 Data relationships](#)).

When indicating this element string in the non-HRI text section of a barcode label, the following data title SHOULD be used: **SHIP TO GEO**

3.7.31 Return-to company name: AI (4310)

The GS1 Application Identifier (4310) indicates that the GS1 Application Identifier data field contains the return-to name of the company associated with the return-to address.

Figure 3.7.31-1. Format of the element string

GS1 Application Identifier	Return-to company name
4 3 1 0	X ₁ —————> variable length —————>X ₃₅

The data transmitted from the barcode reader means that the element string denoting the return-to company name has been captured. As a free text field for transport process information, non-Latin characters and a space character may be encoded, see section [2.6.15](#). As this element string is an attribute to a logistic unit it must be processed together with the SSCC of the unit to which it relates (see section [4.13 Data relationships](#)). When indicating this element string in the non-HRI text section of a barcode label, the following data title SHOULD be used: **RTN TO COMP**

3.7.32 Return-to contact name: AI (4311)

The GS1 Application Identifier (4311) indicates that the GS1 Application Identifier data field contains the contact name for the return-to address. This contact name is the individual intended to receive the logistic unit for returned units.

Figure 3.7.32-1. Format of the element string

GS1 Application Identifier	Return-to contact
4 3 1 1	X ₁ —————> variable length —————>X ₃₅

The data transmitted from the barcode reader means that the element string denoting the Return to contact of a logistic unit has been captured. As a free text field for transport process information, non-Latin characters and a space character may be encoded, see section [2.6.15](#). As this element string is an attribute to a logistic unit it must be processed together with the SSCC of the unit to which it relates (see section [4.13 Data relationships](#)). When indicating this element string in the non-HRI text section of a barcode label, the following data title SHOULD be used: **RTN TO NAME**

3.7.33 Return-to address line 1: AI (4312)

The GS1 Application Identifier (4312) indicates that the GS1 Application Identifier data field contains street address line 1 information for line one of a return to street address for the return-to address (e.g., street).

Figure 3.7.33-1. Format of the element string

GS1 Application Identifier	Return-to address line 1
4 3 1 2	X ₁ —————>variable length —————>X ₇₀

The data transmitted from the barcode reader means that the element string denoting return to address line 1 has been captured. As a free text field for transport process information, non-Latin characters and a space character may be encoded, see section 2.6.15. As this element string is an attribute to a logistic unit it must be processed together with the SSCC of the unit to which it relates (see section 4.13 Data relationships). When indicating this element string in the non-HRI text section of a barcode label, the following data title SHOULD be used: **RTN TO ADD1**

3.7.34 Return-to address line 2: AI (4313)

The GS1 Application Identifier (4313) indicates that the GS1 Application Identifier data field contains street address information for line two of a return-to street address.

Figure 3.7.34-1. Format of the element string

GS1 Application Identifier	Return-to address line 2
4 3 1 3	X ₁ —————> variable length —————> X ₇₀

The data transmitted from the barcode reader means that the element string denoting return-to address line two has been captured. Restrictions apply to the use of AI (4313) in combination with other AIs. (see section 4.13 Data relationships). As a free text field for transport process information, non-Latin characters and a space character may be encoded, see section 2.6.15. When indicating this element string in the non-HRI text section of a barcode label, the following data title SHOULD be used: **RTN TO ADD2**

3.7.35 Return-to suburb: AI (4314)

The GS1 Application Identifier (4314) indicates that the GS1 Application Identifier data field contains suburb information for the return-to address.

Figure 3.7.35-1. Format of the element string

GS1 Application Identifier	Return-to suburb
4 3 1 4	X ₁ —————> variable length —————> X ₇₀

The data transmitted from the barcode reader means that the element string denoting the suburb for the return-to address has been captured. As a free text field for transport process information, non-Latin characters and a space character may be encoded, see section 2.6.15. As this element string is an attribute to a logistic unit it must be processed together with the SSCC of the unit to which it relates (see section 4.13 Data relationships). When indicating this element string in the non-HRI text section of a barcode label, the following data title SHOULD be used: **RTN TO SUB**

3.7.36 Return-to locality: AI (4315)

The GS1 Application Identifier (4315) indicates that the GS1 Application Identifier data field contains locality information for the return-to address. A locality is typically a town or city.

Figure 3.7.36-1. Format of the element string

GS1 Application Identifier	Return to locality
4 3 1 5	X ₁ —————> variable length —————> X ₇₀

The data transmitted from the barcode reader means that the element string denoting the locality for the return to address has been captured. As a free text field for transport process information, non-Latin characters and a space character may be encoded, see section 2.6.15. As this element string is an attribute to a logistic unit it must be processed together with the SSCC of the unit to which it relates (see section 4.13 Data relationships). When indicating this element string in the non-HRI text section of a barcode label, the following data title SHOULD be used: **RTN TO LOC**

3.7.37 Return-to region: AI (4316)

The GS1 Application Identifier (4316) indicates that the GS1 Application Identifier data field contains the region information for the return-to address. Region typically means a first-tier federal state within a country, such as a state in the USA or Australia or a county within the UK.

Figure 3.7.37-1. Format of the element string

GS1 Application Identifier	Return to region
4 3 1 6	X ₁ —————> variable length —————>X ₇₀

The data transmitted from the barcode reader means that the element string denoting the region for the return-to address has been captured. As a free text field for transport process information, non-Latin characters and a space character may be encoded, see section [2.6.15](#). As this element string is an attribute to a logistic unit it must be processed together with the SSCC of the unit to which it relates (see section [4.13 Data relationships](#)). When indicating this element string in the non-HRI text section of a barcode label, the following data title SHOULD be used: **RTN TO REG**

3.7.38 Return-to country code: AI (4317)

The GS1 Application Identifier (4317) indicates that the GS1 Application Identifier data field contains the country code for the return-to address. Alpha-2 codes from ISO 3166 *Country Codes* SHALL be used, e.g., AT for Austria, AU for Australia.

Figure 3.7.38-1. Format of the element string

GS1 Application Identifier	Return-to country code
4 3 1 7	X ₁ X ₂

The data transmitted from the barcode reader means that the element string denoting the country code for the return-to address has been captured. As this element string is an attribute to a logistic unit it must be processed together with the SSCC of the unit to which it relates (see section [4.13 Data relationships](#)). When indicating this element string in the non-HRI text section of a barcode label, the following data title SHOULD be used: **RTN TO COUNTRY**

3.7.39 Return-to postal code: AI (4318)

The GS1 Application Identifier (4318) indicates that the GS1 Application Identifier data field contains the postal code associated with the return-to address.

Figure 3.7.39-1. Format of the element string

GS1 Application Identifier	Return-to postal code
4 3 1 8	X ₁ —————> variable length —————>X ₂₀

The data transmitted from the barcode reader means that the element string denoting the postal code for the return-to address has been captured. As this element string is an attribute to a logistic unit it must be processed together with the SSCC of the unit to which it relates (see section [4.13 Data relationships](#)). When indicating this element string in the non-HRI text section of a barcode label, the following data title SHOULD be used: **RTN TO POST**

3.7.40 Return-to telephone number: AI (4319)

The GS1 Application Identifier (4319) indicates that the GS1 Application Identifier data field contains the phone number associated with the return-to address.

Figure 3.7.40-1. Format of the element string

GS1 Application Identifier	Return-to phone number
4 3 1 9	X ₁ —————> variable length —————>X ₃₀

The data transmitted from the barcode reader means that the element string denoting the phone number for the return-to address has been captured. As this element string is an attribute to a logistic unit it must be processed together with the SSCC of the unit to which it relates (see section [4.13 Data relationships](#)).

This AI permits up to 30 alphanumeric characters from the GS1 AI encodable character set 82, figure [7.11-1](#). It is recommended to specify a full International Direct Dial (IDD) phone number including country code, area code and subscriber number (and any extension if required). Note that a space character is not included in figure [7.11-1](#), so hyphen character may be used in place of space.

ITU standard E.164 format is an all-numeric format for IDD and assumes that the country code are the first digits; it contains no International Dialling Prefix.

For example, the IDD format of GS1 Global Office telephone number is +32-2-788-78-00. The E.164 format for the same example is 3227887800. Either format (IDD or E.164) (e.g., +32-2-788-78-00 or 3227887800) is acceptable for the value of this Application Identifier.

When indicating this element string in the non-HRI text section of a barcode label, the following data title SHOULD be used: **RTN TO PHONE**

3.7.41 Service code description: AI (4320)

The GS1 Application Identifier (4320) indicates that the GS1 Application Identifier data field contains a description of the type of service or handling appropriate for the logistic unit.

Figure 3.7.41-1. Format of the element string

GS1 Application Identifier	Service code description
4 3 2 0	X ₁ —————> variable length —————>X ₃₅

The data transmitted from the barcode reader means that the element string denoting the type of service or handling appropriate for the logistic unit has been captured. The description may be a text field determined by the shipping company using this AI. As a free text field for transport process information, non-Latin characters and a space character may be encoded, see section [2.6.15](#). As this element string is an attribute to a logistic unit it must be processed together with the SSCC of the unit to which it relates (see section [4.13 Data relationships](#)). When indicating this element string in the non-HRI text section of a barcode label, the following data title SHOULD be used: **SRV DESCRIPTION**

3.7.42 Dangerous goods flag: AI (4321)

The GS1 Application Identifier (4321) indicates that the GS1 Application Identifier data field contains an indication that the logistic unit does or does not include dangerous goods.

Figure 3.7.42-1.Format of the element string

GS1 Application Identifier	Dangerous goods flag	Defined values
4 3 2 1	N ₁	0 (indicates not a dangerous good) 1 (indicates a dangerous good)

The data transmitted from the barcode reader means that the element string denoting dangerous goods flag has been captured. To indicate the item is not a dangerous good a zero will be encoded in the data, to indicate the item contains a dangerous good a one will be encoded in the data. As this element string is an attribute to a logistic unit it must be processed together with the SSCC of the unit to which it relates (see section [4.13 Data relationships](#)). When indicating this element string in the non-HRI text section of a barcode label, the following data title SHOULD be used:

DANGEROUS GOODS

3.7.43 Authority to leave flag: AI (4322)

The GS1 Application Identifier (4322) indicates that the GS1 Application Identifier data field indicates whether an item can be left with the recipient without requiring a signature or other confirmation.

Figure 3.7.43-1. Format of the element string

GS1 Application Identifier	Authority to leave flag	Defined values
4 3 2 2	N ₁	0 (meaning no) 1 (meaning yes)

The data transmitted from the barcode reader means that the element string denoting authority to leave flag has been captured. To indicate no (not authorised to leave) a zero will be encoded in the data, when indicating yes (authorised to leave) a one will be encoded in the data. As this element string is an attribute to a logistic unit it must be processed together with the SSCC of the unit to which it relates (see section 4.13 *Data relationships*). When indicating this element string in the non-HRI text section of a barcode label, the following data title SHOULD be used: **AUTH LEAVE**

3.7.44 Signature required flag: AI (4323)

The GS1 Application Identifier (4323) indicates that the GS1 Application Identifier data field indicates whether a signature is required when delivering a logistic unit.

Figure 3.7.44-1. Format of the element string

GS1 Application Identifier	Signature required flag	Defined values
4 3 2 3	N ₁	0 (meaning no) 1 (meaning yes)

The data transmitted from the barcode reader means that the element string denoting signature required has been captured. To indicate no (no signature required) a zero will be encoded in the data, when indicating yes (signature is required) a one will be encoded in the data. As this element string is an attribute to a logistic unit it must be processed together with the SSCC of the unit to which it relates (see section 4.13 *Data relationships*). When indicating this element string in the non-HRI text section of a barcode label, the following data title SHOULD be used: **SIG REQUIRED**

3.7.45 Not before delivery date/time: AI (4324)



The GS1 Application Identifier (4324) indicates that the data fields contain not before delivery date and time. This date indicates that the logistic unit cannot be delivered before the indicated date and local time to the receiver.

Figure 3.7.45-1 Format of the element string

GS1 Application Identifier	Not before delivery date/time				
	YY	MM	DD	HH	MM
4 3 2 4	N ₁ N ₂	N ₃ N ₄	N ₅ N ₆	N ₇ N ₈	N ₉ N ₁₀

The structure is:

- Year: the tens and units of the year (e.g., 2007 = 07), which is mandatory
- Month: the number of the month (e.g., January = 01), which is mandatory
- Day: the number of the day of the relevant month (e.g., second day = 02), which is mandatory
- Hour and Minutes: the number of the hour and minutes based on a local 24-hour time (e.g., 2:30 p.m. = 1430). If it is not necessary to specify a time, these fields must be filled with nines.

- 
Note: When it is not necessary to specify the day (the day field is filled with two zeroes), the resultant data string SHALL be interpreted as the last day of the noted month including any adjustment for leap years (e.g., "130200" is "2013 February 28", "160200" is "2016 February 29", etc.).
- 
Note: This element string can only specify dates ranging from 49 years in the past to 50 years in the future. Determination of the correct century is explained in section [7.12](#).

The data transmitted from the barcode reader means that the element string denoting a not before delivery data/time has been captured. As this element string is an attribute to a logistic unit it must be processed together with the SSCC of the unit to which it relates (see section [4.13 Data relationships](#)). When indicating this element string in the non-HRI text section of a barcode label, the following data title SHOULD be used: **NBEF DEL DT**







3.7.46 Not after delivery date/time: AI (4325)

The GS1 Application Identifier (4325) indicates that the data fields contain not after delivery date and time. This date indicates that the logistic unit cannot be delivered after the indicated date and local time to the receiver.

Figure 3.7.46-1 Format of the element string

GS1 Application Identifier	Not after delivery date/time				
	YY	MM	DD	HH	MM
4 3 2 5	N ₁ N ₂	N ₃ N ₄	N ₅ N ₆	N ₇ N ₈	N ₉ N ₁₀

The structure is:

- 
 Year: the tens and units of the year (e.g., 2007 = 07), which is mandatory.
 - 
 Month: the number of the month (e.g., January = 01), which is mandatory.
 - 
 Day: the number of the day of the relevant month (e.g., second day = 02), which is mandatory
 - 
 Hour and Minutes: the number of the hour and minutes based on a local 24-hour time (e.g., 6:30 p.m. = 1830). If it is not necessary to specify a time, these fields must be filled with nines.
- 
Note: When it is not necessary to specify the day (the day field is filled with two zeroes), the resultant data string SHALL be interpreted as the last day of the noted month including any adjustment for leap years (e.g., "130200" is "2013 February 28", "160200" is "2016 February 29", etc.).
 - 
Note: This element string can only specify dates ranging from 49 years in the past to 50 years in the future. Determination of the correct century is explained in section [7.12](#).

The data transmitted from the barcode reader means that the element string denoting a not after delivery data/time has been captured. As this element string is an attribute to a logistic unit it must be processed together with the SSCC of the unit to which it relates (see section [4.13 Data relationships](#)). When indicating this element string in the non-HRI text section of a barcode label, the following data title SHOULD be used: **NAFT DEL DT**

3.7.47 Release date: AI (4326)

The GS1 Application Identifier (4326) indicates that the data fields contain the release for the logistic unit. This date indicates that the logistic unit can be released for delivery after the indicated date.

Figure 3.7.47-1 Format of the element string

GS1 Application Identifier	Release date		
	YY	MM	DD
4 3 2 6	N ₁ N ₂	N ₃ N ₄	N ₅ N ₆

The structure is:

- Year: the tens and units of the year (e.g., 2007 = 07), which is mandatory
- Month: the number of the month (e.g., January = 01), which is mandatory
- Day: the number of the day of the relevant month (e.g., second day = 02), which is mandatory

The data transmitted from the barcode reader means that the element string denoting a release date has been captured. As this element string is an attribute to a logistic unit it must be processed together with the SSCC of the unit to which it relates (see section [4.13 Data relationships](#)). When indicating this element string in the non-HRI text section of a barcode label, the following data title SHOULD be used: **REL DATE**

3.7.48 Maximum temperature in Fahrenheit: AI (4330)

The GS1 Application Identifier (4330) indicates that the data field contains the maximum temperature, measured in hundredths of degrees Fahrenheit, allowed for the transport and storage of the logistic unit.

The GS1 system provides standards for temperatures in Fahrenheit and Celsius units of measure. A maximum temperature SHALL NOT be applied in more than one unit of measure.

Figure 3.7.48-1 Format of the element string

GS1 Application Identifier	Temperature	
	Absolute value of temperature (Measured in Fahrenheit with two decimal precision)	Negative Temperature Indicator (when required)
4 3 3 0	N ₁ N ₂ N ₃ N ₄ N ₅ N ₆	-

The structure is:

- Absolute value of the temperature in Fahrenheit with two decimal precision: Last two digits will be after a decimal point (e.g., 023020 = 230.20° F)
- Negative temperature indicator: If a negative temperature is intended, a "-" is encoded as the last character in this AI field (e.g., 000250- = -2.50° F). If a "-" is not encoded as the last character, the digits indicate a positive temperature.

The data transmitted from the barcode reader means that the element string denoting a maximum temperature in hundredths of degrees Fahrenheit has been captured. As this element string is an attribute to a logistic unit it must be processed together with the SSCC of the unit to which it relates (see section [4.13 Data relationships](#)). When indicating this element string in the non-HRI text section of a barcode label, the following data title SHOULD be used: **MAX TEMP F**

3.7.49 Maximum temperature in Celsius: AI (4331)

The GS1 Application Identifier (4331) indicates that the data field contains the maximum temperature, measured in hundredths of degrees Celsius, allowed for the transport and storage of the logistic unit.

The GS1 system provides standards for temperatures in Fahrenheit and Celsius units of measure. A maximum temperature SHALL NOT be applied in more than one unit of measure.

Figure 3.7.49-1 Format of the element string

GS1 Application Identifier	Temperature	
	Absolute value of temperature (Measured in Celsius with two decimal precision)	Negative Temperature Indicator (when required)
4 3 3 1	N ₁ N ₂ N ₃ N ₄ N ₅ N ₆	-

The structure is:

- Absolute value of the temperature in Celsius with two decimal precision: Last two digits will be after a decimal point (e.g., 000090 = 0.90° C)
- Negative temperature indicator: If a negative temperature is intended, a "-" is encoded as the last character in this AI field (e.g., 001000- = -10.00° C). If a "-" is not encoded as the last character, the digits indicate a positive temperature.

The data transmitted from the barcode reader means that the element string denoting a maximum temperature in hundredths of degrees Celsius has been captured. As this element string is an attribute to a logistic unit it must be processed together with the SSCC of the unit to which it relates (see section [4.13 Data relationships](#)). When indicating this element string in the non-HRI text section of a barcode label, the following data title SHOULD be used: **MAX TEMP C**

3.7.50 Minimum temperature in Fahrenheit: AI (4332)

The GS1 Application Identifier (4332) indicates that the data field contains the minimum temperature, measured in hundredths of degrees Fahrenheit, allowed for the transport and storage of the logistic unit.

The GS1 system provides standards for temperatures in Fahrenheit and Celsius units of measure. A minimum temperature SHALL NOT be applied in more than one unit of measure.

Figure 3.7.50-1 Format of the element string

GS1 Application Identifier	Temperature	
	Absolute value of temperature (Measured in Fahrenheit with two decimal precision)	Negative Temperature Indicator (when required)
4 3 3 2	N ₁ N ₂ N ₃ N ₄ N ₅ N ₆	-

The structure is:

- Absolute value of the temperature in Fahrenheit with two decimal precision: Last two digits will be after a decimal point (e.g., 023020 = 230.20° F)
- Negative temperature indicator: If a negative temperature is intended, a "-" is encoded as the last character in this AI field (e.g., 000250- = -2.50° F). If a "-" is not encoded as the last character, the digits indicate a positive temperature.

The data transmitted from the barcode reader means that the element string denoting a minimum temperature in hundredths of degrees Fahrenheit has been captured. As this element string is an attribute to a logistic unit it must be processed together with the SSCC of the unit to which it relates (see section [4.13 Data relationships](#)). When indicating this element string in the non-HRI text section of a barcode label, the following data title SHOULD be used: **MIN TEMP F**

3.7.51 Minimum temperature in Celsius: AI (4333)

The GS1 Application Identifier (4333) indicates that the data field contains the minimum temperature, measured in hundredths of degrees Celsius, allowed for the transport and storage of the logistic unit.

The GS1 system provides standards for temperatures in Fahrenheit and Celsius units of measure. A minimum temperature SHALL NOT be applied in more than one unit of measure.

Figure 3.7.51-1 Format of the element string

GS1 Application Identifier	Temperature	
	Absolute value of temperature (Measured in Celsius with two decimal precision)	Negative Temperature Indicator (when required)
4 3 3 3	N ₁ N ₂ N ₃ N ₄ N ₅ N ₆	-

The structure is:

- Absolute value of the temperature in Celsius with two decimal precision: Last two digits will be after a decimal point (e.g., 000090 = 0.90° C)
- Negative temperature indicator: If a negative temperature is intended, a “-” is encoded as the last character in this AI field (e.g., 001000- = -10.00° C). If a “-” is not encoded as the last character, the digits indicate a positive temperature.

The data transmitted from the barcode reader means that the element string denoting a minimum temperature in hundredths of degrees Celsius has been captured. As this element string is an attribute to a logistic unit it must be processed together with the SSCC of the unit to which it relates (see section [4.13 Data relationships](#)). When indicating this element string in the non-HRI text section of a barcode label, the following data title SHOULD be used: **MIN TEMP C**

3.8 GS1 Application Identifiers starting with digit 7

3.8.1 Seven series AIs - Cautionary note

GS1 Application Identifiers issued in the 7 series represent a special case because they are restricted to:

- one or a small number of sectors (i.e. are not multi-sectoral) or
- a country or a region (i.e. are not global).

3.8.2 NATO Stock Number (NSN): AI (7001)

The GS1 Application Identifier (7001) indicates that the GS1 Application Identifier data field contains a NATO stock number.

The NATO stock number is the number allocated to any item of supply in the NATO Alliance. It is the responsibility of the country that manufactures or controls the design of the item to allocate the number.

- ✔ **Note:** This element string is only for use within the context of the supply within the NATO Alliance. Use of it is subject to the rules and regulations of the Allied Committee 135 (AC/135), the NATO Group of National Directors on Codification.

Figure 3.8.2-1. Format of the element string

GS1 Application Identifier	NATO supply classification	Assigning country	Sequential number
7 0 0 1	N ₁ N ₂ N ₃ N ₄	N ₅ N ₆	N ₇ N ₈ N ₉ N ₁₀ N ₁₁ N ₁₂ N ₁₃

The data transmitted from the barcode reader means that the element string denoting a NATO stock number has been captured. As this element string is an attribute of a trade item, it must be processed together with the GTIN of the trade item to which it relates (see section [4.13 Data relationships](#)).

When indicating this element string in the non-HRI text section of a barcode label, the following data title SHOULD be used: **NSN**

3.8.3 UNECE meat carcasses and cuts classification: AI (7002)

The GS1 Application Identifier (7002) indicates that the GS1 Application Identifier data field contains a United Nations Economic Commission for Europe (UNECE, formerly known as UN/ECE) meat carcasses and cuts classification code. The UNECE meat carcasses and cuts code is an attribute of a Global Trade Item Number (GTIN) that denotes the trade description of the product. It is an alphanumeric, variable length code up to 30 characters.

- ✔ **Note:** This element string is only for use within the context of UNECE standards for the quality of meat carcasses and cuts (bovine, porcine, ovine, and caprine).

Figure 3.8.3-1. Format of the element string

GS1 Application Identifier	UNECE product classification
7 0 0 2	X ₁ ————variable length————>X ₃₀

The data transmitted from the barcode reader means that the element string denoting a UNECE meat carcasses and cuts code has been captured. As this element string is an attribute of a trade item, it must be processed together with the GTIN of the trade item to which it relates (see section [4.13 Data relationships](#)).

When indicating this element string in the non-HRI text section of a barcode label, the following data title SHOULD be used: **MEAT CUT**

3.8.4 Expiration date and time: AI (7003)

The GS1 Application Identifier (7003) indicates that the data fields contain expiration date and time. The manufacturer determines the expiration date and time, which is relevant only for short duration and for items that will not be sent on long distances and not outside of the time zone.

A typical application of AI (7003) is in hospitals or public pharmacies for special, customised, products which may have a "life duration" shorter than one single day. The life duration varies according the pharmaceutical substances used in the treatment. The precise expiration date and time is defined at the end of the manufacturing process, and can be barcoded on the product label as an attribute to the item's GTIN. Where there is no business requirement to express the expiration date to the nearest hour (or less), AI (17) Expiration date should be used.

The structure is:

- Year: the tens and units of the year (e.g., 2007 = 07), which is mandatory.
- Month: the number of the month (e.g., January = 01), which is mandatory.
- Day: the number of the day of the relevant month (e.g., second day = 02), which is mandatory.
- Hour: the number of the hour based on local 24-hour time (e.g., 2 p.m. = 14), which is mandatory.
- Minutes: the number of the minutes based on local time (e.g., 15 minutes. = 15); if it is not necessary to specify the minutes, the field must be filled with two zeroes. Time will then be interpreted as ending on the hour (e.g., 14:00 = expiry time at 14:00).

- ✔ **Note:** element string can only specify dates in the range from 49 years in the past to 50 years in the future. Determination of the correct century is explained in section [7.12](#).

Figure 3.8.4-1. Format of the element string

GS1 Application Identifier	Expiration date and time				
	YY	MM	DD	HH	MM
7 0 0 3	N ₁ N ₂	N ₃ N ₄	N ₅ N ₆	N ₇ N ₈	N ₉ N ₁₀

The data transmitted from the barcode reader means that the element string denoting an expiration date and time has been captured. As this element string is an attribute of a trade item, it must be

processed together with the GTIN of the trade item to which it relates (see section [4.13 Data relationships](#)).

When indicating this element string in the non-HRI text section of a barcode label, the following data title SHOULD be used: **EXPIRY TIME**

3.8.5 Active potency: AI (7004)

The GS1 Application Identifier (7004) indicates that the GS1 Application Identifier data field contains an active potency.

The active potency of certain healthcare products (e.g., certain biologics, such as haemophilia products) varies by batch, and this will vary, within agreed tolerances, from the nominal potency of the trade item. Both the nominal and active potency of the item are measured in International Units (IUs).

Figure 3.8.5-1. Format of the element string

GS1 Application Identifier	Active potency
7 0 0 4	N ₁ —variable length—→ N ₄

The data transmitted from the barcode reader means that the Active potency of a Trade Item has been captured. The active potency must be processed with the GTIN and batch or lot number of the trade item to which it relates (see section [4.13 Data relationships](#)).

When indicating this element string in the non-HRI text section of a barcode label, the following data title SHOULD be used: **ACTIVE POTENCY**

3.8.6 Catch area: AI (7005)

The GS1 Application Identifier (7005) indicates that the GS1 Application Identifier data field contains the Catch Area. The Catch Area identifies where the fisheries product was caught using the international fishing areas and subareas as defined by the United Nations Fisheries and Aquaculture Department of the Food and Agricultural Organization (FAO) A complete FAO Catch Area list can be accessed via: <http://www.fao.org/fishery/area/search/en>. It is assigned by the fishing vessel that has caught the fisheries product. These major fishing areas comprise:

- Major inland fishing areas covering the inland waters of the continents,
- Major marine fishing areas covering the waters of the Atlantic, Indian, Pacific and Southern Oceans, with their adjacent seas.

✓ **Note:** The major fishing areas, inland and marine, as well as the subareas can be identified when using this GS1 Application Identifier; FAO example: 27.8.e.2 West of Bay of Biscay Non-NEAFC Regulatory Area

Figure 3.8.6-1. Format of the element string

GS1 Application Identifier	Catch area
7 0 0 5	X ₁ ———>variable length ———>X ₁₂

The data transmitted from the barcode reader means that the element string denoting the Catch Area that has been captured. As this element string is an attribute of a trade item, it must be processed together with the GTIN of the trade item to which it relates (see section [4.13 Data relationships](#)).

When indicating this element string in the non-HRI text section of a barcode label, the following data title SHOULD be used: **CATCH AREA**

3.8.7 First freeze date: AI (7006)

The GS1 Application Identifier (7006) indicates that the GS1 Application Identifier data field contains a first freeze date. The first freeze date is applicable to products that are frozen directly after slaughtering, harvesting, catching or after initial processing of the product. Examples include fresh meat, meat products or fishery products. The first freeze date is determined by the organisation conducting the freezing.

The structure is:

- Year: the tens and units of the year (e.g., 2003 = 03), which is mandatory.
- Month: the number of the month (e.g., January = 01), which is mandatory.
- Day: the number of the day of the relevant month (e.g., second day = 02); this field must always be filled.

✓ **Note:** This element string can only specify dates ranging from 49 years in the past to 50 years in the future. Determination of the correct century is explained in section [7.12](#).

Figure 3.8.7-1. Format of the element string

GS1 Application Identifier	First freeze date		
	Year	Month	Day
7 0 0 6	N ₁ N ₂	N ₃ N ₄	N ₅ N ₆

The data transmitted from the barcode reader means that the element string denoting a first freeze date has been captured. As this element string is an attribute of a trade item, it must be processed together with the trade item GTIN to which it relates (see section [4.13 Data relationships](#)).

When indicating this element string in the non-HRI text section of a barcode label, the following data title SHOULD be used: **FIRST FREEZE DATE**

3.8.8 Harvest date: AI (7007)

The GS1 Application Identifier (7007) indicates that the GS1 Application Identifier data field contains a harvest date or date range. For example, the harvest date can be the date or date range when an animal was slaughtered or killed, a fish has been harvested, or a crop was harvested. This date or date range is determined by the organisation conducting the harvesting. Different organisations may use more specific terminology when referring to their specific needs and use terms such as: Date of catch or slaughter date. When referring to animals the date range refers to the whole animal and all meat or fish cuts derived from this animal.

The structure includes two distinct segments:

- Start date: This specifies the start of the time period being identified:
 - Year: the tens and units of the year (e.g., 2003 = 03), which is mandatory.
 - Month: the number of the month (e.g., January = 01), which is mandatory.
 - Day: the number of the day of the relevant month (e.g., second day = 02); for a harvest date. This field must always be filled.
- End date: This specifies the end of the time period being identified:
 - Year: the tens and units of the year (e.g., 2003 = 03).
 - Month: the number of the month (e.g., January = 01).
 - Day: the number of the day of the relevant month (e.g., second day = 02); for a harvest date.

✓ **Note:** This element string can only specify dates ranging from 49 years in the past to 50 years in the future. Determination of the correct century is explained in section [7.12](#).

- 
Note: In case the catch period spans one calendar day, the end date SHALL NOT be specified. In case the catch period spans multiple calendar days, both the start and end date must be specified, with the end date being greater than the start date.

Figure 3.8.8-1. Format of the element string

GS1 Application Identifier	Harvest start date			Harvest end date		
	Year	Month	Day	Year	Month	Day
7 0 0 7	N ₁ N ₂	N ₃ N ₄	N ₅ N ₆	N ₇ N ₈	N ₉ N ₁₀	N ₁₁ N ₁₂

The data transmitted from the barcode reader means that the element string denoting a harvest date range has been captured. As this element string is an attribute of a trade item, it must be processed together with the GTIN of the trade item to which it relates (see section [4.13 Data relationships](#)).

When indicating this element string in the non-HRI text section of a barcode label, the following data title SHOULD be used: **HARVEST DATE**

3.8.9 Species for fishery purposes: AI (7008)

The GS1 Application Identifier (7008) indicates that the GS1 Application Identifier data field contains the fish species according to the 3-alpha Aquatic Sciences and Fisheries Information System (ASFIS) list of species.

The United Nations Fisheries and Aquaculture Department of the Food and Agricultural Organization (FAO) Fisheries and Aquaculture Statistics and Information Service (FIPS) collates world capture and aquaculture production statistics at the species, genus, family or higher taxonomic levels in 2,119 statistical categories (2011 data) referred to as species items. ASFIS list of species includes 12,421 species items selected according to their interest or relation to fisheries and aquaculture. For each species item stored in a record, codes (International Standard Statistical Classification of Aquatic Animals and Plants group, taxonomic and 3-alpha) and taxonomic information (scientific name, author(s), family and higher taxonomic classification) are provided. An English name is available for most of the records, and about one third of them have also a French and Spanish name. Information is also provided about the availability of fishery production statistics on the species item in the FAO databases; example: IZX. This list can be accessed via:

<http://www.fao.org/fishery/collection/asfis/en>

Figure 3.8.9-1. Format of the element string

GS1 Application Identifier	Species for fishery purposes code
7 0 0 8	X ₁ —variable length—> X ₃

The data transmitted from the barcode reader means that the element string denoting the species for fishery purposes that has been captured. As this element string is an attribute of a trade item, it must be processed together with the GTIN of the trade item to which it relates (see section [4.13 Data relationships](#)).

When indicating this element string in the non-HRI text section of a barcode label, the following data title SHOULD be used: **AQUATIC SPECIES**

3.8.10 Fishing gear type: AI (7009)

The GS1 Application Identifier (7009) indicates that the GS1 Application Identifier data field contains the information on the fishing gear type.

It is assigned by the fishing vessel that has caught the fisheries product. The fishing gear type, as defined by the United Nations Fisheries and Aquaculture Department of the Food and Agricultural Organization (FAO), is used to identify the type of fishing gear used for catching the fisheries product. The fishing gear type list provides definitions of fishing gear of all kinds, grouped by categories. These definitions and classifications are valid on a world-wide basis for both inland waters and sea fisheries, as well as, for small-, medium- and large-scale fisheries; example: 01.1.1

(one boat operated purse seines). This list can be accessed via:
<http://www.fao.org/fishery/cwp/handbook/M/en>.

Figure 3.8.10-1. Format of the element string

GS1 Application Identifier	Fishing gear type
7 0 0 9	X ₁ — variable length —>X ₁₀

The data transmitted from the barcode reader means that the element string denoting the fishing gear type that has been captured. This element string is an attribute of a trade item, it must be processed together with the GTIN of the trade item to which it relates (see section 4.13 *Data relationships*).

When indicating this element string in the non-HRI text section of a barcode label, the following data title SHOULD be used: **FISHING GEAR TYPE**

3.8.11 Production method: AI (7010)

The GS1 Application Identifier (7010) indicates that the GS1 Application Identifier data field describes the production method.

It is assigned by the fishing vessel that has caught the fisheries product. The **production method** provides the production method for fish and seafood as specified by the Fisheries and Aquaculture Department of the Food and Agricultural Organization (FAO) of the United Nations; example: 01.

The allowed values, as defined by the Fisheries and Aquaculture Department of the Food and Agricultural Organization (FAO) of the United Nations are:

- 01 'Caught at Sea'.
- 02 'Caught in Fresh Water'.
- 03 'Farmed'.
- 04 'Cultivated'.

Figure 3.8.11-1. Format of the element string

GS1 Application Identifier	Production method
7 0 1 0	X ₁ — variable length —>X ₂

The data transmitted from the barcode reader means that the element string denoting the production method has been captured. As this element string is an attribute of a trade item, it must be processed together with the GTIN of the trade item to which it relates (see section 4.13 *Data relationships*).

When indicating this element string in the non-HRI text section of a barcode label, the following data title SHOULD be used: **PROD METHOD**

3.8.12 Test by date: AI (7011)

The GS1 Application Identifier (7011) indicates that the GS1 Application Identifier data field contains a test by date and optional time. The test by date and optional time is specified by the manufacturer as the last date and time the product is acceptable for use without testing. For instance, the manufacturer may use the test by date to indicate when an ingredient used in the manufacture of a pharmaceutical product is to be tested.

The structure is:

- Year: the tens and units of the year (e.g., 2003 = 03), which is mandatory.
- Month: the number of the month (e.g., January = 01), which is mandatory.
- Day: the number of the day of the relevant month (e.g., second day = 02), which is mandatory.

- Hour and minutes: the hour and minutes based on local 24-hour time (e.g., 2:30 p.m. =1430), which is optional
- ✔ **Note:** This element string can only specify dates ranging from 49 years in the past to 50 years in the future. Determination of the correct century is explained in section [7.12](#).
- ✔ **Note:** The day of the month SHALL NOT be expressed as two zeroes. A valid day of the month (e.g., last day of July = 31) SHALL be included.

Figure 3.8.12-1. Format of the element string

GS1 Application Identifier	Test by date				
	Test by date			Test by time (optional)	
	Year	Month	Day	Hour	Minutes
7 0 1 1	N ₁ N ₂	N ₃ N ₄	N ₅ N ₆	N ₇ N ₈	N ₉ N ₁₀

The data transmitted from the barcode reader means that the element string denoting a test by date and optional time has been captured. As this element string is an attribute of a trade item, it must be processed together with the GTIN to which it relates (see section [4.13 Data relationships](#)). After the test by date if the product is determined to be fit for use, the result should be communicated by the responsible party and, if necessary, a new test by date established.

When indicating this element string in the non-HRI text section of a barcode label, the following data title SHOULD be used: **TEST BY DATE**

3.8.13 Refurbishment lot ID: AI (7020)

GS1 Application Identifier (7020) indicates that the GS1 Application Identifier data field contains a refurbishment lot ID.

Together with the GTIN of the trade item and the GLN of the production or service location, the refurbishment lot ID identifies a batch of items that were remanufactured to the original specifications using a combination of reused, repaired and new parts. It is an alphanumeric, variable length string of up to 20 characters.

Figure 3.8.13-1. Format of the element string

GS1 Application Identifier	Refurbishment lot ID
7 0 2 0	X ₁ ———— variable length —————>X ₂₀

The data transmitted from the barcode reader means that the element string denoting a refurbishment lot ID has been captured. It must be processed together with the GLN of the production/service location and the GTIN of the item to which it is related (see section [4.13 Data relationships](#)).

When indicating this element string in the non-HRI text section of a barcode label, the following data title SHOULD be used: **REFURB LOT**

3.8.14 Functional status: AI (7021)

GS1 Application Identifier (7021) indicates that the GS1 Application Identifier data field contains the functional status.

The functional status of the trade item may need to be included by the manufacturer to meet regulatory or commercial requirements. For example requirements related to the type approval, allowing the trade item to be sold in a particular country.

Figure 3.8.14-1. Format of the element string

GS1 Application Identifier	Functional status
7 0 2 1	X ₁ ———— variable length —————>X ₂₀

The data transmitted from the barcode reader means that the element string denoting a functional status has been captured. As this element string is an attribute of a trade item, it must be processed in combination with the GTIN of the item to which it is related (see section [4.13 Data relationships](#)).

When indicating this element string in the non-HRI text section of a barcode label, the following data title SHOULD be used: **FUNC STAT**

3.8.15 Revision status: AI (7022)

GS1 Application Identifier (7022) indicates that the GS1 Application Identifier data field contains the revision status.

The revision status of the trade item may need to be included by the manufacturer to meet regulatory or commercial requirements. For example, requirements related to the type approval, allowing the trade item to be sold in a particular country.

Figure 3.8.15-1. Format of the element string

GS1 Application Identifier	Revision status
7 0 2 2	X ₁ ———— variable length —————>X ₂₀

The data transmitted from the barcode reader means that the element string denoting a revision status has been captured. As this element string is subordinate to the functional status, it must be processed in combination with the functional status and the GTIN of the item to which it is related (see section [4.13 Data relationships](#)).

When indicating this element string in the non-HRI text section of a barcode label, the following data title SHOULD be used: **REV STAT**

3.8.16 Global Individual Asset Identifier of an assembly: AI (7023)

GS1 Application Identifier (7023) indicates that the GS1 Application Identifier data field contains the GIAI (Global Individual Asset Identifier) of an assembly.

An additional barcode containing the GIAI of an assembly may need to be marked on a sub-component of the assembly (the so called leading part) in case the assembly does not have a surface that uniquely belongs to the assembly (and not to any of its sub-components). In order to distinguish between the identifier of the sub-component and the identifier of the assembly a separate GS1 application identifier is used for the latter.

The GS1 Company Prefix (see section [1.4.4](#)) is allocated by GS1 Member Organisations to the company that allocates the GIAI – the asset owner or manager of the individual asset.

The structure and content of the individual asset reference is at the discretion of the asset owner or manager. It may contain all characters listed in figure [7.11-1](#).

Figure 3.8.16-1. Format of the element string

GS1 Application Identifier	Global Individual Asset Identifier (GIAI) of an assembly			
	GS1 Company Prefix		Individual asset reference	
7 0 2 3	N ₁ ...	N _i	X _{i+1} ...	variable length X _j (j<=30)

The data transmitted from the barcode reader means that the element string denoting a parent GIAI has been captured.

When indicating this element string in the non-HRI text section of a barcode label, the following data title SHOULD be used: **GIAI - ASSEMBLY**

3.8.17 Number of processor with three-digit ISO country code: AI (703s)

The GS1 Application Identifier (703s) indicates that the GS1 Application Identifier data fields contain the ISO country code and approval number or GLN of the processor of a trade item. The number of processor is an attribute to a Global Trade Item Number (GTIN). It designates the number of the company who did the processing.

As many processors may be involved, each with an individual approval number, the fourth digit of the AI (s in the figure below) indicates the sequence of the processors.

For a typical meat supply chain, the following sequence would be used:

- 7030: slaughterhouse
- 7031: first deboning/cutting hall
- 7032 to 7037: second through seventh processing location (cutting hall)
- 7038: slaughterhouse
- 7039: slaughterhouse

For a typical seafood supply chain, the following sequence would be used:

- 7030 vessel/aquaculture site
- 7031 primary processor
- 7032 secondary processor

The ISO country code contains the three-digit country number of the numerical international standard *ISO 3166* that relates to the following approval number of processor.

If '999' is entered as the ISO country code it signifies that the subsequent data is a Global Location Number (GLN), and not an 'approval number'.

- ✓ **Note:** The approval number is usually assigned by a national or pluri-national authority to processors in the food supply chain. These authorities may choose to use the Global Location Number (GLN) (see section 2.4) for this purpose. The approval number (or GLN) remains with the item regardless of whether or not it changes ownership or function.

Figure 3.8.17-1. Format of the element string

GS1 Application Identifier	ISO country code	Number of processor
7 0 3 s	N ₁ N ₂ N ₃	X ₄ — variable length —> X ₃₀

The data transmitted from the barcode reader means that the element string denoting the ISO country code and number of processor has been captured. As this element string is an attribute of a trade item, it must be processed together with the GTIN of the trade item to which it relates (see section 4.13 *Data relationships*).

When indicating this element string in the non-HRI text section of a barcode label, the following data title SHOULD be used: **PROCESSOR # s**

3.8.18 GS1 UIC with Extension 1 and Importer index: AI (7040)

The GS1 Application Identifier (7040) indicates that the GS1 Application Identifier data field contains the Unique Identification Code of an EU 2018/574 ID Issuer, the National Authority that appointed it (via the GS1 UIC Extension 1), and, if applicable, the Importer (via an Importer Index). The UIC begins with one numeric digit followed by one alphanumeric character from the ISO/IEC 646 invariant character set per figure 7.11-1. The GS1 UIC Extension 1 is one alphanumeric character from the ISO/IEC 646 invariant character set per figure 7.11-1. The Importer Index is one character and include A-Z, a-z, 0-9, - (hyphen) and _ (underscore). Underscore is used to indicate the importer

index does not apply (null). The other characters identify up to 63 importers of a product per country of placement. This identifier is authorised for use by the ID Issuer as long as it meets minimum requirements established by GS1. The use of UIC is limited to application standard [2.1.14](#) European Regulation 2018/574, traceability of tobacco products. The UIC shall be used solely exclusively to facilitate identification of country level authorisation for GS1 identification keys within illicit trade surveillance systems. The UIC shall not be used with GS1 identification keys for open, supply chain systems.

Figure 3.8.18-1. Format of the element string

GS1 Application Identifier	GS1 UIC with Extension 1 and Importer index		
	GS1 UIC	Extension 1	Importer index
7 0 4 0	N ₁ X ₂	X ₃	X ₄

The data transmitted from the barcode reader means that the element string denoting a Unique Identification Code has been captured.

When indicating this element string in the non-HRI text section of a barcode label, this element string in the non-HRI text section of a barcode label, the following data title SHOULD be used: **UIC+EXT**

3.8.19 UN/CEFACT freight unit type: AI (7041)

The GS1 Application Identifier (7041) indicates that the data field contains the type of freight of the logistic unit. The codes used for freight unit type are the UN/CEFACT alphanumeric codes. GS1 maintains a list based on the UN/ECE Recommendation 21 codes on [GS1 Navigator](#) which includes some additional GS1 code values. All codes in the UN/ECE Recommendation 21 and GS1 code list are valid codes to be used with AI (7041). A list of code values maintained by GS1 can be viewed at: <https://navigator.gs1.org/edi/codelist-details?name=PackageTypeCode>.

Figure 3.8.19-1. Format of the element string

GS1 Application Identifier	UN/CEFACT freight unit type code
7 0 4 1	X ₁ —— variable length ——>X ₄

The data transmitted from the barcode reader means that the element string denoting the freight unit type has been captured. As this element string is an attribute to a logistic unit it must be processed together with the SSCC of the unit to which it relates (see section [4.13 Data relationships](#)). When indicating this element string in the non-HRI text section of a barcode label, the following data title SHOULD be used: **UFRGT UNIT TYPE**

3.8.20 National Healthcare Reimbursement Number (NHRN): AIs (710), (711), (712), (713), (714), (715) and (716)

The GS1 Application Identifiers (710), (711), (712), (713), (714), (715) and (716) indicate that the GS1 Application Identifier data field contains a National Healthcare Reimbursement Number, from the NHRN GS1 Application Identifier series, associated to the Global Trade Item Number (GTIN) of the trade item. The GS1 Application Identifiers (710), (711), (712), (713), (714), (715) and (716) indicate a specific NHRN from within the assigned series.

Use of the NHRN GS1 Application Identifier, associated to the GTIN of the trade item, is needed for compliance with a national/regional regulatory or industry requirement where the GTIN will not meet the need.

GTIN is the GS1 identifier for pharmaceutical and medical device trade items. The GS1 Application Identifier for National Healthcare Reimbursement Number is provided to meet regulatory or industry requirements until they are amended to accept the GTIN as a compliant identifier.

Within this application are the rules and recommendations for the association of NHRNs to the Global Trade Item Number (GTIN) where regulatory requirements require an NHRN for product identification, registration or reimbursement purposes.

There are a number of known NHRNs but at this time not all are required to be encoded within the data carrier found on the trade item. Flexibility for additional assigned NHRN AIs has been provided if required.

The National Healthcare Reimbursement Number GS1 Application Identifier is an initial step in a migration path to the most efficient method to identify trade items. GS1 recommends that Healthcare stakeholders faced with national numbers:

- a. Use GTIN for all supply chain and reimbursement purposes (GTIN used in the data carrier and as the NHRN) as this is the most efficient and effective way for all stakeholders to identify trade items.
- b. Use GTIN, cross-referenced to an NHRN in an existing database, in the case of an existing system of NHRNs (i.e. GTIN used in the data carrier with the NHRN found via cross-reference).
- c. Use GTIN with an associated NHRN (GTIN and NHRN both used in the data carrier via the NHRN AI) as an intermediate solution for those who cannot use "a" or "b". GS1 only recommends this as a migration path to noted options "a" or "b".

! Important:

- There is a mandatory association of the National Healthcare Reimbursement Number Application Identifier with the GTIN.
- The NHRN is usually assigned by a national authority to healthcare brand owners for specific trade items and SHALL only be used for compliance to regulatory requirements where the GTIN alone will not meet the requirements.
- Additional individual NHRN AIs can only be assigned by GS1 and only in response to a work request being submitted through GSMP.
- The GTIN and all associated NHRNs SHOULD be concatenated into a single data carrier (i.e. single GS1-128, GS1 DataMatrix).
- Use of NHRN on the item is controlled by and subject to the rules and regulations of national/regional agencies. Those rules and/or regulations may supersede these recommendations.
- More than one NHRN may need to be associated with a given GTIN.

The general format of an NHRN GS1 Application Identifier is:

Figure 3.8.20-1. Format of the element string

GS1 Application Identifier	National Healthcare Reimbursement Number
n n n	X ₁ — variable length —> X ₂₀

When an NHRN AI is approved, the overall variable length (i.e. allowable number of characters) is specified by the national authority, with a twenty (20) character maximum as noted in the general format above if applicable.

The GS1 Application Identifiers used with this element string, their specific format and associated regulatory body or assigning organisation, are shown in the figure below:

Figure 3.8.20-2. Overview of NHRN Application Identifiers

GS1 Application Identifier	National Healthcare Reimbursement Number			Organisation
710	X ₁	variable length	X ₂₀	Germany IFA
711	X ₁	variable length	X ₂₀	France CIP
712	X ₁	variable length	X ₂₀	Spain National Code
713	X ₁	variable length	X ₂₀	Brazil ANVISA
714	X ₁	variable length	X ₂₀	Portugal INFARMED

GS1 Application Identifier	National Healthcare Reimbursement Number			Organisation
715	X ₁	variable length	X ₂₀	United States of America FDA
716	X ₁	variable length	X ₂₀	Italy AIFA
nnn (*)	X ₁	variable length	X ₂₀	Country "A" NHRN Authority

(*) An example to illustrate future additional NHRNs. If additional NHRN AIs are required, a request for a new NHRN AI SHALL be made through GSMP.

Companies wishing to apply one of the listed NHRN AIs will need to associate that NHRN AI to the trade item's GTIN according to the NHRN AI rules and should contact their GS1 Member Organisation for further considerations of use.

The data transmitted from the barcode reader means that the element string denoting a National Healthcare Reimbursement Number has been captured. This element string is an attribute of a trade item and must be processed together with the GTIN of the trade item to which it relates (see section [4.13 Data relationships](#)).

When indicating this element string in the non-HRI text section of a barcode label, the data title listed in figure [3.2-1](#) SHOULD be used.

3.8.21 Certification reference: AI (723s)

The GS1 Application Identifier (723s) indicates that the GS1 Application Identifier data field contains a reference to a product certification. The certification reference is an attribute of a trade item or an individual asset.

As multiple certificates may be present, each with an individual certification reference, the fourth digit of the AI (s in the figure below) indicates the sequence of the certification references.

The general structure of AI (723s) is:

- Certification scheme (2 characters) defined by GS1. The following code values are currently allowed:
 - "EM" (European Marine Equipment Directive). See <http://eur-lex.europa.eu/legal-content/EN/AUTO/?uri=CELEX:32018R0608> for more information.
- Certification reference (28 characters)

Figure 3.8.21-1. Format of the element string

GS1 Application Identifier	Certification scheme	Certification reference
7 2 3 s	X ₁ X ₂	X ₃ —variable length—> X ₃₀

The data transmitted from the barcode reader means that the element string denoting the certification reference has been captured. As this element string is an attribute of a trade item or an asset, it must be processed together with the GTIN of the trade item or the GIAI of the asset to which it relates (see section [4.13 Data relationships](#)).

When indicating this element string in the non-HRI text section of a barcode label, the following data title SHOULD be used: **CERT # s**

3.8.22 Protocol ID: AI (7240)

The GS1 Application Identifier (7240) indicates that the GS1 Application Identifier data field contains the identifier of a clinical trial protocol. The data is alphanumeric and may include all characters listed in figure [7.11-1](#).

Figure 3.8.22-1. Format of the element string

GS1 Application Identifier	Protocol ID
7 2 4 0	X_1 —variable length— X_{20}

The data transmitted from the barcode reader means that the element string denoting the protocol ID has been captured. As this element string is an attribute of a trade item, it must be processed together with the GTIN of the trade item to which it relates (see section [4.13 Data relationships](#)).

When indicating this element string in the non-HRI text section of a barcode label, the following data title SHOULD be used: **PROTOCOL**

3.8.23 AIDC media type: AI (7241)

The GS1 Application Identifier (7241) indicates that the GS1 Application Identifier data field contains an AIDC media type. The AIDC media type allows the differentiation of what type of object or entity the GS1 AIDC data carrier is displayed or carried on. For example, a GS1 AIDC data carrier encoded with a Global Service Relation Number (GSRN) may be displayed on an identity card or an order form.

The structure and content of the AIDC media type are defined in figure 3.8.22-1 and figure 3.8.22-3 to ensure the correct AIDC media type value is referenced. An overview of the AIDC media type value ranges is provided in figure 3.8.22-2.

Figure 3.8.23-1. Format of the element string

GS1 Application Identifier	AIDC media type - value
7 2 4 1	$N_1 N_2$

The data transmitted from the barcode reader means that the element string denoting an AIDC media type has been captured. Since the AIDC media type is an attribute of a service relation, it must be processed together with the GSRN of the service relation to which it relates (see section [4.13 Data relationships](#)).

When indicating this element string in the non-HRI text section of a barcode label, the following data title SHOULD be used: **AIDC MEDIA TYPE**



Figure 3.8.23-2. Overview of the AIDC media type table values

AIDC media type - value	AIDC media type – value range assignments
00	Not used
01 to 10	Current ICCBBA assignment
11 to 29	Reserved for ICCBBA future assignment
30 to 59	Reserved for GS1 assignment
60 to 79	Reserved for future capacity needs of ICCBBA or GS1 if the initial capacity of values for either organisation is exhausted
80 to 99	Reserved for local or national use

Figure 3.8.23-3. AIDC media type table values

AIDC media type value	AIDC media type	Defined by
00	Not used	ICCBBA
01	Wristband	ICCBBA

02	Order form	ICCBBA
03	Sample Tube	ICCBBA
04	Working list / Lab list / form	ICCBBA
05	Test report	ICCBBA
06	Delivery note / issue documentation	ICCBBA
07	Intended recipient label (attached to container)	ICCBBA
08	Label affixed to product	ICCBBA
09	Identity card	ICCBBA
10	Clinical or progress notes	ICCBBA
11-29	Reserved for ICCBBA future assignment	ICCBBA
30-59	Reserved for GS1 future assignment	GS1
60-79	Reserved for future capacity needs of ICCBBA or GS1 if the initial capacity of values for either organisation is exhausted	ICCBBA or GS1
80-99	Reserved for local or national use	ICCBBA

- 
Note: The values above are technical standards. Normative GS1 use of these values is established within application standards (e.g., management of biological samples could potentially use this AI on several AIDC media types, for example, a patient wristband, the sample tube itself, or a staff ID card).
- 
Note: GS1 and ICCBBA independently, but collaboratively, administer AIDC media type value definitions and their normative use. For example, GS1 may or may not normatively use a media type defined by ICCBBA and vice versa. This independence could result in a duplicate value if both organisations were considering it at the same time. To avoid this, both organisations have agreed to notify the other when new values are being considered.

ICCBBA - www.isbt128.org - is an international non-profit organisation, based in the US, that manages, develops, and licenses ISBT 128, the international information standard for the terminology, coding and labelling of medical products of human origin. The acronym ICCBBA is derived from the International Council for Commonality in Blood Banking Automation.

ICCBBA - ISBT 128 - Table RT018 detailing their AIDC media type – definitions:
www.isbt128.org/RT018

3.8.24 Version Control Number (VCN): AI (7242)

The GS1 Application Identifier (7242) indicates that the GS1 Application Identifier data field contains a Version Control Number (VCN).

VCN is used when there is a need to differentiate or distinguish between identification that may be present multiple times on the same AIDC media type. For example, when AIDC media such as an ID badge carrying the GSRN of a service provider (8017), or a patient wristband displaying the GSRN of a service recipient (8018) needs to be replaced due to being lost or discarded, the VCN enables distinction between the re-issued AIDC media and any previous versions.

The structure and content of the VCN is at the discretion of the organisation managing issuance and validation of the physical identification entity.

Figure 3.8.24-1. Format of the element string

GS1 Application Identifier	Version control number (VCN)
7 2 4 2	X ₁ — variable length —> X ₂₅

The data transmitted from the barcode reader means that the element string denoting Version Control Number has been captured. Since the VCN is an attribute of a service relation, it must be processed together with the GSRN of the service relation to which it relates (see section [4.13 Data relationships](#)). When indicating this element string in the non-HRI text section of a barcode label, the following data title SHOULD be used: **VCN**

! **Important:** Prior to the development of the Version Control Number (VCN), the SRIN could also be optionally used with a GSRN as a sequence indicator for version control purposes. Use of the SRIN in this manner presents challenges when further requirements to qualify a service encounter are necessary, in addition to version control. For new version control requirements, the VCN SHALL be used instead of the SRIN.

3.8.25 Date of birth: AI (7250)

The GS1 Application Identifier (7250) indicates that the GS1 Application Identifier data field contains the date of birth, the date of birth structure is:

- Year: the thousands, the hundreds, the tens and units of the year (e.g., 2003 = 2003), which is mandatory. The use of thousands and hundreds for persons is based on life expectancy potentially exceeding 100 years.
- Month: the number of the month (e.g., January = 01), which is mandatory.
- Day: the number of the day of the relevant month (e.g., second day = 02), which is mandatory.

Figure 3.8.25-1. Format of the element string

GS1 Application Identifier	Date of birth							
	Year		Month		Day			
7 2 5 0	N ₁	N ₂	N ₃	N ₄	N ₅	N ₆	N ₇	N ₈

The data transmitted from the barcode reader means that the element string denoting a date of birth has been captured. As this element string is an attribute of a GSRN - RECIPIENT, it must be processed together with the GSRN to which it relates (see section [4.13 Data relationships](#)).

When indicating this element string in the non-HRI text section of a barcode label, the following data title SHOULD be used: **DOB**

3.8.26 Date and time of birth: AI (7251)

The GS1 Application Identifier (7251) indicates that the GS1 Application Identifier data field contains a date and time of birth, the date and time of birth structure is:

- Year: the thousands, the hundreds, the tens and units of the year (e.g., 2003 = 2003), which is mandatory. The use of thousands and hundreds for persons is based on life expectancy potentially exceeding 100 years.

- Month: the number of the month (e.g., January = 01), which is mandatory.
- Day: the number of the day of the relevant month (e.g., second day = 02), which is mandatory.
- Hour: the number of the hour based on local 24-hour time (e.g., 2 p.m. = 14), which is mandatory.
- Minutes: the number of the minutes based on local time (e.g., 15 minutes = 15), which is mandatory.

Figure 3.8.26-1. Format of the element string

GS1 Application Identifier	Date and time of birth				
	YYYY	MM	DD	HH	MM
7 2 5 1	N ₁ N ₂ N ₃ N ₄	N ₅ N ₆	N ₇ N ₈	N ₉ N ₁₀	N ₁₁ N ₁₂

The data transmitted from the barcode reader means that the element string denoting a date and time of birth has been captured. As this element string is an attribute of a GSRN – RECIPIENT, it must be processed together with the GSRN – RECIPIENT to which it relates (see section [4.13 Data relationships](#)).

When indicating this element string in the non-HRI text section of a barcode label, the following data title SHOULD be used: **DOB TIME**

- ✔ **Note:** The use of the GS1 Application Identifier (7251) is used for the purposes of recording the date and time of birth of a baby within a maternity environment. When there is no business requirement to express the time of birth then the use of GS1 Application Identifier (7250) should be used.

3.8.27 Biological sex: AI (7252)

The GS1 Application Identifier (7252) indicates that the GS1 Application Identifier data field indicates the biological sex of the subject of care as defined and detailed in “ISO/IEC 5218:2022 Information technology – Codes for the representation of human sexes”.

Figure 3.8.27-1. Format of the element string

GS1 Application Identifier	Biological sex
7 2 5 2	N ₁

The defined values currently in ISO 5218:2022 for biological sex are:

- 0 = Not known
- 1 = Male
- 2 = Female
- 9 = Not applicable

The data transmitted from the barcode reader means that the element string denoting the biological sex has been captured. As this element string is an attribute to a GSRN – RECIPIENT it must be processed together with GSRN - RECIPIENT (see section [4.13 Data relationships](#)).

When indicating this element string in the non-HRI text section of a barcode label, the following data title SHOULD be used: **BIO SEX**

3.8.28 Family name of person: AI (7253)

The GS1 Application Identifier (7253) indicates that the GS1 Application Identifier data field contains family name of person information for the purpose of aiding positive patient identification.

The family name of person field is alphanumeric and may include all characters contained in figure [7.11-1](#)

✓ **Note:** A family name may also be known as a “Surname” or “Last Name”.

Figure 3.8.28-1. Format of the element string

GS1 Application Identifier	Family name of person
7 2 5 3	X ₁ —————>variable length —————>X ₄₀

The data transmitted from the barcode reader means that the element string denoting family name of person has been captured. As this element string is an attribute to the GSRN, it must be processed together with the identification key to which it relates (see section [4.13 Data relationships](#)). As a free text field for positive patient information, non-Latin characters and a space character may be encoded.

When indicating this element string in the non-HRI text section of a barcode label, the following data title SHOULD be used: **FAMILY NAME**

✓ **Note:** To encode non-Latin characters within the alphanumeric value, use percent-encoding as defined within RFC 3986. A space character should be encoded as a single plus symbol, +.

3.8.29 Given name of person: AI (7254)

The GS1 Application Identifier (7254) indicates that the GS1 Application Identifier data field contains given name information for the purpose of aiding positive patient identification.

The given name of person field is alphanumeric and may include all characters contained in figure [7.11-1](#)

✓ **Note:** A given name may also be known as a first name, middle name, forename, second name, other given name or other given name/s.

Figure 3.8.29-1. Format of the element string

GS1 Application Identifier	Given name of person
7 2 5 4	X ₁ —————>variable length —————>X ₄₀

The data transmitted from the barcode reader means that the element string denoting given name of person has been captured. As this element string is an attribute to the GSRN, it must be processed together with the GSRN to which it relates (see section [4.13 Data relationships](#)). As a free text field for positive patient information, non-Latin characters and a space character may be encoded.

When indicating this element string in the non-HRI text section of a barcode label, the following data title SHOULD be used: **GIVEN NAME**

✓ **Note:** To encode non-Latin characters within the alphanumeric value, use percent-encoding as defined within RFC 3986. A space character should be encoded as a single plus symbol, +.

3.8.30 Name suffix of person: AI (7255)

The GS1 Application Identifier (7255) indicates that the GS1 Application Identifier data field contains name suffix of person information for the purpose of aiding identification.

The name suffix of person field is alphanumeric and may include all characters contained in figure [7.11-1](#)

Figure 3.8.30-1. Format of the element string

GS1 Application Identifier	Name suffix of person
7 2 5 5	X ₁ —————>variable length —————>X ₁₀

The data transmitted from the barcode reader means that the element string denoting name suffix of person has been captured. As this element string is an attribute to the GSRN, it must be processed together with the GSRN to which it relates (see section [4.13 Data relationships](#)). When indicating this element string in the non-HRI text section of a barcode label, the following data title SHOULD be used: **SUFFIX**

The following is a list of commonly used abbreviation examples. This list is not exhaustive, the decision as to whether to use the full name suffix or abbreviation is determined based on the maximum allowed field length:

- Junior or Jr
- Senior or Sr
- First or I
- Second or II
- Third or III
- Fourth or IV
- Fifth or V

✔ **Note:** Name suffix is an additional term used following a person’s name to identify a subject of care or provider of care.

3.8.31 Full name of person: AI (7256)

The GS1 Application Identifier (7256) indicates that the GS1 Application Identifier data field contains full name of person information for the purpose of aiding positive patient identification. This field is a composite data element that is captured through the combination of GS1 Application Identifiers (7253) Family name of person, (7254) Given name of person and (7255) Name suffix of person.

The Full name of person field is alphanumeric and may include all characters contained in figure [7.11-1](#)

Figure 3.8.31-1. Format of the element string

GS1 Application Identifier	Full name of person
7 2 5 6	X ₁ —————>variable length —————>X ₉₀

The data transmitted from the barcode reader means that the element string denoting full name of person has been captured. As a free text field for name identification information, non-Latin characters and a space character may be encoded. As this element string is an attribute to the GSRN, it must be processed together with the GSRN to which it relates (see section [4.13 Data relationships](#)).

When indicating this element string in the non-HRI text section of a barcode label, the following data title SHOULD be used: **FULL NAME**

- ✔ **Note:** To encode non-Latin characters within the alphanumeric value, use percent-encoding as defined within RFC 3986. A space character should be encoded as a single plus symbol, +.
- ✔ **Note:** When shown as non-HRI text, it is advised to capitalise the Family name of person field to ensure no confusion with other name fields.
- ✔ **Note:** The order in which these identifiers are used, including their presence and use of a field delimiter, may be determined by regulatory or local user requirements. If a delimiter is required to separate different data fields within the “Full name of person” field then the comma character “,” is recommended for use.

3.8.32 Address of person: AI (7257)

The GS1 Application Identifier (7257) indicates that the GS1 Application Identifier data field contains information about the address of a person for the purpose of aiding positive patient identification (e.g., House number / flat number, street details an example being "Av. Louise 326").

The address of person field is alphanumeric and may include all characters contained in figure [7.11-1](#)

Figure 3.8.32-1. Format of the element string

GS1 Application Identifier	Address of person
7 2 5 7	X ₁ —————>variable length —————>X ₇₀

The data transmitted from the barcode reader means that the element string denoting address of person has been captured. As a free text field for name identification information, non-Latin characters and a space character may be encoded. As this element string is an attribute to the GSRN, it must be processed together with the GSRN to which it relates (see section [4.13 Data relationships](#)).

When indicating this element string in the non-HRI text section of a barcode label, the following data title SHOULD be used: **PERSON ADDR**

- ✔ **Note:** To encode non-Latin characters within the alphanumeric value, use percent-encoding as defined within RFC 3986. A space character should be encoded as a single plus symbol, +.

3.8.33 Baby birth sequence indicator: AI (7258)

The GS1 Application Identifier (7258) indicates that the GS1 Application Identifier data field indicates the baby birth sequence indicator and is used to identify the sequence in which a baby was born and the total number of babies in the series.

Figure 3.8.33-1. Format of the element string

GS1 Application Identifier	Baby birth sequence indicator		
	Sequence of birth of the baby	Sequence separator using solidus character	Total number of babies in the series
7 2 5 8	N ₁	X ₁	N ₁

The first number is the sequence of birth of the baby within the series followed by a "solidus" followed by the second number which is the total number of babies in the series. For example:

- 1/1 – One baby
- 1/2 – First of two babies (twin 1)
- 2/2 – Second of two babies (twin 2)
- 1/3 – First of three babies (triplet 1)
- 2/3 – Second of three babies (triplet 2)
- 3/3 – Third of three babies (triplet 3)

- ✔ **Note:** The second character used in this element string as detailed by X₁ shall be the "solidus" character as represented as the "/" graphic symbol and detailed in figure [7.11-1](#).

The data transmitted from the barcode reader means that the element string denoting the baby birth sequence indicator has been captured. As this element string is an attribute to a GSRN – RECIPIENT it must be processed together with GSRN – RECIPIENT (see section [4.13 Data relationships](#)).

When indicating this element string in the non-HRI text section of a barcode label, the following data title SHOULD be used: **BIRTH SEQUENCE**

3.8.34 Baby of family name: AI (7259)

The GS1 Application Identifier (7259) indicates that the GS1 Application Identifier data field contains Baby of family name information for the purpose of aiding positive patient identification. This field is a composite data element that is captured through the combination of the Application Identifier (7253) Family Name and free text indicating the identification of the specific “baby” being identified.

The Baby of Family Name field is alphanumeric and may include all characters contained in figure [7.11-1](#)

Figure 3.8.34-1. Format of the element string

GS1 Application Identifier	Baby of family name
7 2 5 9	X ₁ —————>variable length —————>X ₄₀

The data transmitted from the barcode reader means that the element string denoting baby of family name has been captured. As a free text field for positive patient information, non-Latin characters and a space character may be encoded. As this element string is an attribute to the GSRN - RECIPIENT, it must be processed together with the GSRN – RECIPIENT to which it relates (see section [4.13 Data relationships](#)).

When indicating this element string in the non-HRI text section of a barcode label, the following data title SHOULD be used: **BABY**

- ✔ **Note:** To encode non-Latin characters within the alphanumeric value, use percent-encoding as defined within RFC 3986. A space character should be encoded as a single plus symbol, +.
- ✔ **Note:** Baby of family name – In many countries it is common for a child to be born and initially not provided a “given name” by the mother, parents etc. Depending on the jurisdiction it then becomes a legal requirement to decide the “given name” within a defined period of time, for example in the UK it is 42 days and Norway it is 90 days.

Note: A family name may also be known as a “surname” or “last name”.

3.9 GS1 Application Identifiers starting with digit 8

3.9.1 Roll products - width, length, core diameter, direction, splices: AI (8001)

The GS1 Application Identifier (8001) indicates that the GS1 Application Identifier data fields contain the variable attributes of a roll product. Depending on the method of production, some roll products cannot be numbered according to standard criteria that have been determined in advance. They are, therefore, classified as variable items. For those products where the standard trade measures are not sufficient, the following guidelines should be used.

The identification of a roll product consists of the Global Trade Item Number (GTIN) and the variable attributes. The basic product (e.g., a certain type of paper) is included as data in the GTIN-14 ID number (see section [2.1.11](#)), and the variables contain information about the special features of the particular item that has been produced. The variable values of a roll product, N1 to N14, consist of the following data:

- N1 to N4: slit width in millimetres (width of the roll)
- N5 to N9: actual length in metres
- N10 to N12: internal core diameter in millimetres
- N13: winding direction (face out 0, face in 1, undefined 9)
- N14: number of splices (0 to 8 = actual number, 9 = number unknown)

Figure 3.9.1-1. Format of the element string

GS1 Application Identifier	Variable values of a roll product				
8 0 0 1	N ₁ N ₂ N ₃ N ₄	N ₅ N ₆ N ₇ N ₈ N ₉	N ₁₀ N ₁₁ N ₁₂	N ₁₃	N ₁₄

The data transmitted from the barcode reader means that the element string denoting the variable attributes of the identification of a roll product trade item have been captured. This element string must be processed together with the GTIN of the trade item to which it relates (see section [4.13 Data relationships](#)). When indicating this element string in the non-HRI text section of a barcode label, the following data title SHOULD be used: **DIMENSIONS**

3.9.2 Cellular mobile telephone identifier: AI (8002)

The GS1 Application Identifier (8002) indicates that the GS1 Application Identifier data field contains the serial number of a cellular mobile telephone.

The serial number field is alphanumeric and may contain all characters contained in figure [7.11-1](#). A national or pluri-national authority usually assigns the number. It uniquely identifies each mobile telephone within a given authority for special control purposes. It is not considered as an attribute of the identification of the telephone as a trade item.

Figure 3.9.2-1. Format of the element string

GS1 Application Identifier	Serial number
8 0 0 2	X ₁ ———variable length ———> X ₂₀

The data transmitted from the barcode reader means that the element string denoting an electronic serial identifier of a cellular mobile telephone has been captured. This element string is normally processed as stand-alone information.

When indicating this element string in the non-HRI text section of a barcode label, the following data title SHOULD be used: **CMT No.**

3.9.3 Global Returnable Asset Identifier (GRAI): AI (8003)

The GS1 Application Identifier (8003) indicates that the GS1 Application Identifier data field contains the GRAI (Global Returnable Asset Identifier). The GRAI is used to identify returnable assets.

The GS1 Company Prefix (see section [1.4.4](#)) is allocated by GS1 Member Organisations to the company that allocates the GRAI – the asset owner or manager of the returnable asset. It makes the number unique worldwide.

When using AI (8003), a leading zero SHALL be required before the GRAI. This zero was originally added to support efficient use in GS1-128. The zero is mandatory for all GS1 barcodes that can encode AI (8003).

The structure and content of the asset type is at the discretion of the asset owner or manager.

The check digit is explained in section [7.9](#). Its verification, which must be carried out in the application software, ensures that the number is correctly composed.

The optional serial component is assigned by the asset owner or manager. It identifies an individual asset within a given asset type. The field is alphanumeric and may contain all characters listed in figure [7.11-1](#).

Figure 3.9.3-1. Format of the element string

GS1 Application Identifier	Lead zero	Global Returnable Asset Identifier (GRAI)			
		GS1 Company Prefix —————>	Asset type ←————	Check digit	Serial component (optional)
8 0 0 3	0	N ₁ N ₂ N ₃ N ₄ N ₅ N ₆ N ₇ N ₈ N ₉ N ₁₀ N ₁₁ N ₁₂		N ₁₃	X ₁ variable X ₁₆

The data transmitted from the barcode reader means that the element string denoting the GRAI has been captured. When indicating this element string in the non-HRI text section of a barcode label, the following data title SHOULD be used: **GRAI**

3.9.4 Global Individual Asset Identifier (GIAI): AI (8004)

The GS1 Application Identifier (8004) indicates that the GS1 Application Identifier data field contains a GIAI (Global Individual Asset Identifier). The GIAI is used for the unique identification of individual assets.

- 
Note: Note: This element string must never be used to identify the entity as a trade item or logistic unit. If an asset is transferred between parties, the GIAI cannot be used for ordering the asset. However, asset identification may be exchanged between parties for the purpose of traceability.

The GS1 Company Prefix (see section 1.4.4) is allocated by GS1 Member Organisations to the company that allocates the GIAI – here the asset owner or manager. It makes the number unique worldwide.

The structure and content of the individual asset reference is at the discretion of the asset owner or manager. It may contain all characters listed in figure 7.11-1.

Figure 3.9.4-1. Format of the element string

GS1 Application Identifier	Global Individual Asset Identifier (GIAI)				
	GS1 Company Prefix		Individual asset reference		
8 0 0 4	$N_1 \dots$	N_i	$X_{i+1} \dots$	variable length	$X_j (j \leq 30)$

The data transmitted from the barcode reader means that the element string denoting a GIAI has been captured. When indicating this element string in the non-HRI text section of a barcode label, the following data title SHOULD be used: **GIAI**

3.9.5 Price per unit of measure: AI (8005)

The GS1 Application Identifier (8005) indicates that the GS1 Application Identifier data field contains a price per unit of measure. This element string is used to indicate the price per unit of measure of price marked goods on a variable measure trade item to discriminate price variants of the same item. It is considered as an attribute of the respective trade item and not as part of its identification.

Content and structure of the price per unit of measure field are left to the discretion of the trading partners.

Figure 3.9.5-1. Format of the element string

GS1 Application Identifier	Price per unit of measure					
8 0 0 5	N_1	N_2	N_3	N_4	N_5	N_6

The data transmitted from the barcode reader means that the element string denoting the price per unit of measure has been captured. As this element string is an attribute of a trade item, it must be processed together with the GTIN of the trade item to which it relates (see section 4.13 *Data relationships*). When indicating this element string in the non-HRI text section of a barcode label, the following data title SHOULD be used: **PRICE PER UNIT**

- 
Note: This element string is not recommended for open and global applications. The use of the element string denoting “Amount payable per unit of measure single monetary area (variable measure trade item)” AI (395n) is recommended instead.

3.9.6 Identification of an individual trade item piece (ITIP): AI (8006)

The GS1 Application Identifier (8006) indicates that the GS1 Application Identifier data field contains the identification of an individual piece of a trade item. The piece is not traded independently and therefore cannot be assigned its own GTIN.

The GTIN that is included in this element string is the GTIN for the complete trade item.

The piece number identifies an individual piece of the trade item. The total count provides the total number of individual pieces of the trade item.

Figure 3.9.6-1. Format of the element string

GS1 Application Identifier	Global Trade Item Number (GTIN)	Piece number	Total count
8 0 0 6	N ₁ N ₂ N ₃ N ₁₂ N ₁₃ N ₁₄	N ₁₅ N ₁₆	N ₁₇ N ₁₈

The data transmitted from the barcode reader means that the element string denoting the identification of an individual piece of a trade item has been captured. When indicating this element string in the non-HRI text section of a barcode label, the following data title SHOULD be used: **ITIP**

 **Note:** ITIP is the preferred data title for AI (8006) and GCTIN was deprecated from use as of January 2020.

3.9.7 International Bank Account Number (IBAN): AI (8007)

The GS1 Application Identifier (8007) indicates that the GS1 Application Identifier data field contains the international bank account identifier.

The International Bank Account Number (IBAN), AI (8007), defined as *ISO 13616*, indicates to which account the amount of the respective payment slip is to be transferred (see section 2.6.6). The invoicing party determines the applicable bank account number. The data field is alphanumeric and may contain all characters contained in figure 7.11-1.

Figure 3.9.7-1. Format of the element string

GS1 Application Identifier	International Bank Account Number
8 0 0 7	X—————variable length—————>X ₃₄

The data string transmitted by the barcode reader means that the element string denoting an IBAN has been captured. Restrictions apply to the use of AI (8007) in combination with other AIs, see section 4.13 *Data relationships*. When indicating this element string in the non-HRI text section of a barcode label, the following data title SHOULD be used: **IBAN**

3.9.8 Date and time of production: AI (8008)

The GS1 Application Identifier (8008) indicates that the GS1 Application Identifier data fields contain a date and time of production (or assembly). The date and time of production is determined by the manufacturer. The date and time may refer to the trade item itself or to the items contained. The structure is:

- Year: the tens and units of the year (e.g., 2000 = 00), which is mandatory.
- Month: the number of the month (e.g., January = 01), which is mandatory.
- Day: the number of the day of the relevant month (e.g., second day = 02), which is mandatory.
- Hour: the number of the hour based on local time (e.g., 2 p.m. = 14), which is mandatory.
- Minutes: may be dropped if not required.
- Seconds: may be dropped if not required.

 **Note:** This element string can only specify dates ranging from 49 years in the past to 50 years in the future. Determination of the correct century is explained in section 7.12.

Figure 3.9.8-1. Format of the element string

GS1 Application Identifier	Date and time of production					
	YY	MM	DD	HH	MM	SS
8 0 0 8	N ₁ N ₂	N ₃ N ₄	N ₅ N ₆	N ₇ N ₈	N ₉ N ₁₀	N ₁₁ N ₁₂

The data transmitted from the barcode reader means that the element string denoting a date and time of production has been captured. As this element string is an attribute of a trade item, it must be processed together with the GTIN of the trade item to which it relates (see section [4.13 Data relationships](#)). When indicating this element string in the non-HRI text section of a barcode label, the following data title SHOULD be used: **PROD TIME**

3.9.9 Optically readable sensor indicator: AI (8009)

The GS1 Application Identifier (8009) indicates that the GS1 Application Identifier data field contains the optically readable sensor instruction parameters defined by AIM (Association for Automatic Identification and Mobility). The parameter field is alphanumeric and may contain all characters contained in figure [7.11-1](#). Refer to AIM, Inc. www.aimglobal.org for the sensor instruction parameters to be encoded.

Figure 3.9.9-1. Format of the element string

GS1 Application Identifier	AIM defined sensor instruction parameters
8 0 0 9	X————variable length————>X ₅₀

 **Note:** This data element is intended to be carrier agnostic, however the user is cautioned regarding payload limitations of GS1 data carriers e.g., GS1-128 (48 total characters)

The data transmitted by the barcode reader means that the element string denoting the parameters of a sensor/monitor has been captured. As this element string is an attribute of a trade item or a logistic unit, it must be processed together with the GTIN of the trade item or the SSCC of the logistic unit to which it relates (see section [4.13 Data relationships](#)).

 **Note:** This element string may appear in a separate barcode (from the one used to encode the GTIN or SSCC).

When indicating this element string in the non-HRI text section of a barcode label, the following data title SHOULD be used: **OPTSEN**

3.9.10 Component/Part Identifier (CPID): AI (8010)

The GS1 Application Identifier (8010) indicates that the GS1 Application Identifier data field contains the C/P Identifier.

The GS1 Company Prefix is allocated by GS1 Member Organisations to the company that allocates the C/P Identifier, making the number unique worldwide.

The structure and content of the C/P reference is at the discretion of the company that has been assigned the GS1 Company Prefix to uniquely identify each C/P.

The C/P reference format is variable length. The Component & Part reference SHALL only consist of numeric, alphabetic upper-case or special characters "#", "-", or "/", see figure [7.11-2](#).

Figure 3.9.10-1. Format of the element string

GS1 Application Identifier	Component/Part Identifier	
	GS1 Company Prefix	C/P reference number
8 0 1 0	N ₁ ... N _j	X _{j+1} ...variable length X _k (k<=30)

The data transmitted from the barcode reader means that the element string denoting a C/P Identifier has been captured. When indicating this element string in the non-HRI text section of a barcode label, the following data title SHOULD be used: **CPID**

3.9.11 Component/Part Identifier serial number: AI (8011)

The GS1 Application Identifier (8011) indicates that the GS1 Application Identifier data field contains a C/P serial number. A C/P serial number is assigned to an entity for its lifetime. When combined with a C/P Identifier, a serial number uniquely identifies an individual item. The C/P serial number field is numeric only. The C/P Identifier issuer (e.g., C/P buyer or OEM) determines the C/P serial number.

The C/P serial number SHALL NOT begin with a "0" digit, unless the entire serial number consists of the single digit "0".

Figure 3.9.11-1. Format of the element string

GS1 Application Identifier	Component/Part Identifier serial number
8 0 1 1	N ₁ —variable length—> N ₁₂

The data transmitted from the barcode reader means that the element string denoting a C/P serial number has been captured. As this element string is an attribute of a component/part, it must be processed together with the C/P Identifier of the component/part to which it relates (see section 4.13 *Data relationships*). When indicating this element string in the non-HRI text section of a barcode label, the following data title SHOULD be used: **CPID SERIAL**

3.9.12 Software version: AI (8012)

The GS1 Application Identifier (8012) indicates that the GS1 Application Identifier data field contains a software version number. Software versioning is the process of assigning unique version numbers to unique states of computer software.

Examples include:

- Software versions for regulated healthcare device software.
- Commercially available office productivity software (Microsoft® Word 2013 version 15.0.4701.1001, Adobe® Reader® XI version 11.0.10).

This AI may be combined with AI 10 (lot/batch) when the manufacturer decides that both lot and version control are required to meet regulatory or commercial requirements.

The data is alphanumeric and may include all characters contained in figure 7.11-1.

Figure 3.9.12-1. Format of the element string

GS1 Application Identifier	Software version
8 0 1 2	X ₁ —variable length—> X ₂₀

The data transmitted by the barcode reader means that the element string denoting a software version has been captured. As this element string is an attribute of a software trade item, it must be processed with the GTIN of the software to which it is related (see section 4.13 *Data relationships*). When indicating this element string in the non-HRI text section of a label, the following data title SHOULD be used: **VERSION**

3.9.13 Global Model Number (GMN): AI (8013)

The GS1 Application Identifier (8013) indicates that the GS1 Application Identifier data field contains a GMN (Global Model Number). The GMN is used for the unique identification of a product model.

 **Note:** This element string SHALL NOT be used to identify the entity as a trade item.

The GS1 Company Prefix (see section 1.4.4) is allocated by GS1 Member Organisations to the brand owner that allocates the GMN. It makes the number unique worldwide. .

The structure and content of the model reference is at the discretion of the brand owner. It may contain all characters listed in figure 7.11-1.

The check character pair is explained in section 7.9.5. Its verification, which must be carried out in the application software, ensures that the identifier is correctly composed.

The total length of the GMN including the check characters SHALL NOT exceed 25 characters.

Figure 3.9.13-1. Format of the element string

GS1 Application Identifier	Global Model Number (GMN)				
	GS1 Company Prefix		Model reference		Check characters
8 0 1 3	$N_1 \dots N_i$	$X_{i+1} \dots$	variable length	$X_j (j \leq 23)$	$X_{j+1} X_{j+2}$

When indicating this element string in the non-HRI text section, the following data title SHOULD be used: **GMN**

Regulated healthcare medical devices

For regulated healthcare medical devices, the GMN SHALL NOT be used in any labelling, physical marking, or GS1 AIDC data carrier on associated trade items.

When indicating the Basic UDI-DI (GMN) on documents or certificates, the following data title SHOULD be used: **GMN**

The Application Identifier (AI) 8013 SHALL be excluded in such documents and certificates.

For medical devices that fall under the EU regulations (see section 2.6.13).

3.9.14 Highly Individualised Device Registration Identifier (HIDRI): AI (8014)

The GS1 Application Identifier (8014) indicates that the GS1 Application Identifier data field contains the Highly Individualised Device Registration Identifier (HIDRI) but are currently identified with a made-to-stock GTIN for other business purposes. It is used for the unique identification of a family of standard contact lenses that will be registered in EUDAMED (European database on medical devices).

The structure and content of the grouping reference are at the discretion of the brand owner. It may contain all characters listed in figure 7.11-1.

The check character pair is explained in section 7.9.5. Its verification, which must be carried out in the application software, ensures that the identifier is correctly composed.

As the Highly Individualised Device Registration Identifier (HIDRI) is stored within the UDI-DI field within EUDAMED, this element string SHALL contain at least one non-numeric character within the "grouping reference" data structure to ensure against any potential conflict with existing GTINs.

Figure 3.9.14-1 Format of the element string

GS1 Application Identifier	Highly Individualised Device Registration Identifier (HIDRI)				
	GS1 Company Prefix		Grouping reference		Check characters
8 0 1 4	$N_1 \dots N_i$	$X_{i+1} \dots$	variable length	$X_j (j \leq 23)$	$X_{j+1} X_{j+2}$

When indicating this element string in the non-HRI text section, the following data title SHOULD be used: **MUDI**

- 
Note: This element string SHALL never be used to identify the entity as a trade item. The GS1 Company Prefix (see section 1.4.4) is allocated by GS1 Member Organisations to the brand owner that allocates the MUDI-DI. It makes the number unique worldwide. The MUDI-DI can be used in any labelling, physical marking, or GS1 AIDC data carrier on associated trade items. For the purpose of EUDAMED access, HIDRI is sufficient as a standalone key. When used in a barcode with production identifiers (e.g., lot number, serial number), HIDRI shall be associated with GTIN as the Application Identifiers for production identifiers have a mandatory association with GTIN

- 
Note: This element string can be up to 25 characters in length and can go as low as 8 to 15 characters and shall include the GS1 Company Prefix, at least one non-numeric character as the grouping reference, and the check character pair.

3.9.15 Global Service Relation Number (GSRN): AIs (8017, 8018)

The GS1 Application Identifiers (8017, 8018) indicate that the GS1 Application Identifier data field contains a GSRN (Global Service Relation Number). The GSRN is used to identify either the recipient or individual provider of services in the context of a service relationship. In order to provide identification for both roles in a service relationship, recipient and provider, two GSRN AIs are available. The resultant element string provides a means for the service provider to store data relevant to services provided to the recipient and by the individual provider.

The GS1 Company Prefix is allocated by GS1 Member Organisations to the company that allocates the GSRN – here the organisation offering the service (see section 1.4.4). It makes the number unique worldwide.

The structure and content of the service reference is at the discretion of the organisation offering the service in order to uniquely identify each service relation.

The check digit is explained in section 7.9. Its verification, which must be carried out in the application software, ensures that the number is correctly composed.

The Global Service Relation Number – Provider (see figure below) identifies the relationship between an organisation offering services and the provider of services.

Figure 3.9.15-1. Format of the element string

GS1 Application Identifier	Global Service Relation Number (GSRN) - PROVIDER		
	GS1 Company Prefix	Service reference	Check digit
8 0 1 7	N ₁ N ₂ N ₃ N ₄ N ₅ N ₆ N ₇ N ₈ N ₉ N ₁₀ N ₁₁ N ₁₂ N ₁₃ N ₁₄ N ₁₅ N ₁₆ N ₁₇		N ₁₈

The data transmitted from the barcode reader means that the element string denoting the Global Service Relation Number for the Provider has been captured.

When indicating this element string in the non-HRI text section of a barcode label, the following data title SHOULD be used: **GSRN – PROVIDER**

The Global Service Relation Number – Recipient identifies the relationship between an organisation offering services and the recipient of services.

Figure 3.9.15-2. Format of the element string

GS1 Application Identifier	Global Service Relation Number (GSRN) - RECIPIENT		
	GS1 Company Prefix	Service reference	Check digit
8 0 1 8	N ₁ N ₂ N ₃ N ₄ N ₅ N ₆ N ₇ N ₈ N ₉ N ₁₀ N ₁₁ N ₁₂ N ₁₃ N ₁₄ N ₁₅ N ₁₆ N ₁₇		N ₁₈

The data transmitted from the barcode reader means that the element string denoting Global Service Relation Number for the Recipient has been captured. When indicating this element string in the non-HRI text section of a barcode label, the following data title SHOULD be used: **GSRN - RECIPIENT**

 **Note:** AI (8017) and AI (8018) must not be used in combination, see section [4.13 Data relationships](#).

3.9.16 Service Relation Instance Number (SRIN): AI (8019)

The GS1 Application Identifier (8019) indicates that the GS1 Application Identifier data field contains a Service Relation Instance Number (SRIN). The SRIN is used when the Global Service Relation Number (GSRN) of a service provider (8017) or service recipient (8018) needs to be further qualified with a sequence indicator corresponding to an encounter or an instance of a service.

The structure and content of the Service Relation Instance Number is at the discretion of the organisation offering the service, in order to uniquely identify each service relation instance.

Figure 3.9.16-1. Format of the element string

GS1 Application Identifier	Service Relation Instance Number
8 0 1 9	N ₁ —variable length—> N ₁₀

The data transmitted from the barcode reader means that the element string denoting a Service Relation Instance Number has been captured. Since the SRIN is an attribute of a service relation, it must be processed with the GSRN of the service relation to which it relates (see section [4.13 Data relationships](#)). When indicating this element string in the non-HRI text section of a barcode label, the following data title SHOULD be used: **SRIN**

3.9.17 Payment slip reference number: AI (8020)

The GS1 Application Identifier (8020) indicates that the GS1 Application Identifier data field contains a payment slip reference number.

The payment slip reference number, assigned by the invoicing party, identifies a payment slip within a given Global Location Number (GLN) of an invoicing party (see section [2.6.6](#)). Together with the GLN of the invoicing party, the payment slip reference number uniquely identifies a payment slip. The data field is alphanumeric and may contain all characters contained in figure [7.11-1](#).

Figure 3.9.17-1. Format of the element string

GS1 Application Identifier	Payment slip reference number
8 0 2 0	X ₁ —variable length—> X ₂₅

The data string transmitted from the barcode reader means that the element string denoting a payment slip reference number has been captured. Restrictions apply to the use of AI (8020) in combination with other AIs, see section [4.13 Data relationships](#).

When indicating this element string in the non-HRI text section of a barcode label, the following data title SHOULD be used: **REF No.**

3.9.18 Identification of pieces of a trade item (ITIP) contained in a logistic unit: AI (8026)

The GS1 Application Identifier (8026) indicates that the GS1 Application Identifier data field includes the ITIP of the contained pieces of a trade item. The ITIP is used to identify a piece of a trade item.

The GTIN that is included in this element string is the GTIN for the complete trade item.

The piece number identifies a piece of the trade item. The total count provides the total number of pieces of the trade item.

Figure 3.9.18-1. Format of the element string

GS1 Application Identifier	Global Trade Item Number (GTIN)	Piece number	Total count
8 0 2 6	N ₁ N ₂ N ₃ N ₁₂ N ₁₃ N ₁₄	N ₁₅ N ₁₆	N ₁₇ N ₁₈

Note: This element string SHALL be used only on a logistic unit if:

- the logistic unit is not itself a trade item; and
- all the pieces of the trade item that are contained have the same ITIP.

The data transmitted from the barcode reader means that the element string denoting the ITIP of the trade item piece contained in a logistic unit has been captured. This element string must be processed together with the count of items which must appear on the same unit (see section [4.13 Data relationships](#)).

When indicating this element string in the non-HRI text section of a barcode label, the following data title SHOULD be used: **ITIP CONTENT**

3.9.19 Digital Signature (DigSig): AI (8030)

The GS1 Application Identifier (8030) indicates that the GS1 Application Identifier data field is a Digital Signature (DigSig) that is in conformance with ISO/IEC 20248 Information technology – *Automatic identification and data capture techniques – Digital signature data structure schema* - <https://www.iso.org/standard/81314.html>. The DigSig data field SHALL only consist of alphanumeric characters from the file-safe/URI-safe base64 character set (a 64-character subset of ISO/IEC 646 Table 1) as defined in section 5 of [RFC 4648](#), see figure [7.11-3](#).

Figure 3.9.19-1. Format of the element string

GS1 Application Identifier	Digital Signature (DigSig)
8 0 3 0	Z ₁ ————— variable length —————> Z ₉₀

The data transmitted from the barcode reader means that the element string denoting a Digital Signature (DigSig) has been captured. As this element string is an attribute of a trade item, asset, coupon, document, component, service relationship or logistic unit, it must be processed together with the identifier of the physical object to which it relates (see section [4.13 Data relationships](#)).

When indicating this element string in the non-HRI text section of a barcode label, the following data title SHOULD be used: **DIGSIG**

3.9.20 Coupon code identification for use in North America (AI 8110)

See GS1 US for the *North American Coupon Application Guideline using GS1 DataBar Expanded Symbols* for detailed information on GS1 US coupon code data content.

The coupon barcode is constructed by starting with a coupon GS1 Application Identifier (8110), followed by the required and optional data elements, until all desired data is encoded (or the limit of 70 digits is reached).

Figure 3.9.20-1. Format of the element string

GS1 Application Identifier	Formatted according to rules of North American Coupon Application Guideline using GS1 DataBar Expanded Symbols
8 1 1 0	X ₁ ————— variable length —————> X ₇₀

The data string transmitted from the barcode reader means that the element string denoting a Coupon code for use in North America has been captured.

3.9.21 Loyalty points of a coupon: AI (8111)

The GS1 Application Identifier (8111) indicates that the GS1 Application Identifier data field contains the loyalty points of a coupon.

Figure 3.9.21-1. Format of the element string

GS1 Application Identifier	Loyalty points of a coupon
8 1 1 1	N ₁ N ₂ N ₃ N ₄

The data string transmitted from the barcode reader means that the element string denoting the loyalty points of a coupon has been captured. This element string must be processed together with the Global Coupon Number, AI (255) of the coupon to which it relates (see section [4.13 Data relationships](#)).

When indicating this element string in the non-HRI text section of a barcode label, the following data title SHOULD be used: **POINTS**

3.9.22 Positive offer file coupon code identification for use in North America: (AI 8112)

See GS1 US for the North American coupon application guidelines for detailed information on GS1 US coupon code data content.

The positive offer file coupon data string is constructed by starting with a coupon GS1 Application Identifier (8112), followed by the required and optional data elements, until all desired data is encoded (or the limit of 70 characters is reached).

Figure 3.9.22-1. Format of the element string

GS1 Application Identifier	Formatted according to rules of North American coupon application guidelines
8 1 1 2	X ₁ ———variable length—————>X ₇₀

The data string transmitted means that the element string denoting a positive offer file coupon code for use in North America has been captured.

3.9.23 Extended packaging URL: AI (8200)

The GS1 Application Identifier (8200) indicates that the GS1 Application Identifier data fields contain the identification of a brand owner authorised URL to be used in mandatory association with GTIN AI (01) encoded in one symbol.

Figure 3.9.22-1. Format of the element string

GS1 Application Identifier	Brand owner authorised URL
8 2 0 0	X ₁ ———variable length—————>X ₇₀

The data transmitted from the barcode reader means that the element string denoting the Extended Packaging URL for a trade item has been captured. This element string SHALL be processed as specified in section [2.1.13](#) to obtain one URL address associated with the trade item identified by the GTIN.

When indicating this element string in the non-HRI text section of a barcode label, the following data title SHOULD be used: **PRODUCT URL**

3.10 GS1 Application Identifiers starting with digit 9

3.10.1 Information mutually agreed between trading partners: AI (90)

The GS1 Application Identifier (90) indicates that the GS1 Application Identifier data field contains any information mutually agreed between trading partners.

The data field shows the information agreed between the two trading partners. The field is alphanumeric and may contain all characters contained in figure 7.11-1. It may also be used to incorporate data preceded by ASC MH10 Data Identifiers.

Figure 3.10.1-1. Format of the element string

GS1 Application Identifier	Data field
9 0	X ₁ ——variable length——>X ₃₀

The data transmitted from the barcode reader means that the element string denoting mutually agreed information has been captured. As this element string may contain any information, processing is subject to prior agreement between trading partners.

! **Important:** The barcode carrying this element string SHOULD be removed from any item that leaves the jurisdiction of the trading partners.

When indicating this element string in the non-HRI text section of a barcode label, the following data title SHOULD be used: **INTERNAL**

3.10.2 Company internal information: AIs (91 - 99)

The GS1 Application Identifier (A1 A2) assigned to company internal information is AI (91 to 99).

The GS1 Application Identifier data field may contain any company internal information. The field is alphanumeric and may show all characters contained in figure 7.11-1.

Figure 3.10.2-1. Format of the element string

GS1 Application Identifier	Data field
A ₁ A ₂	X ₁ ——variable length——> X ₉₀

✓ **Note:** Use of this Application Identifier for field lengths greater than 41 data characters will require the appropriate data carrier selection, see section 2.6.10.

The data transmitted from the barcode reader means that the element string denoting company internal information has been captured. Processing of this element string is to be organised by the using company.

! **Important:** This element string SHOULD be removed from any item that leaves the jurisdiction of the company.

When indicating this element string in the non-HRI text section of a barcode label, the following data title SHOULD be used: **INTERNAL**

3.11 Compatibility of EPC Tag Data Standard and GS1 General Specifications

The GS1 Application Identifiers, defined in this section of the *GS1 General Specifications*, may be used in GS1 barcodes in line with the application standards outlined in section 2. GS1 Application Identifiers may also be used in EPC/RFID tags as defined in the latest version of the [EPC Tag Data Standard](#).

- ✔ **Note:** Some EPC Binary Coding Schemes are unable to encode the full serial number values defined in section 3. See Table 12-2 of the [EPC Tag Data Standard](#) for limitations imposed on serial numbers within the EPC Binary Coding Schemes.

4 Application rules and management practices

4.1 Introduction

The main purpose of Automatic Data Capture (ADC) is to replace manual entry of information. This implies that an ADC message must provide all information required for a transaction without human intervention. GS1 system data may be used, for example, to record entities in computer files, to sort goods on conveyor belts, to check completeness of a consignment, to verify dates and to record physical stock taking.

Element strings may be applied directly on physical goods or printed in catalogues or documents. The scanning source and the type of transaction determine the required information in a given business application. Since all ADC data is being used in data sharing applications, strict validation of data to be processed is an absolute prerequisite.

For correct processing of scanned data, certain business applications may require the association of element strings representing a particular combination of identification data. The GS1 system enables users to achieve the needed level of data accuracy through the use of adequate element strings.

The logical set up of the data standard of the GS1 system enables system users to validate scanned data messages (see section [7](#)).

Validation is affected on two levels. The first is validation of the data for conformity with system rules (e.g., to provide a message that contains all information to be processed logically without human intervention). The second level is validation of the data for conformity with the requirements of a particular business application.

Section [4.13](#) shows the rules for the first verification level (e.g., validate data to conform with the system logic). Section [4.13.1](#) defines the pairs of element strings that cannot appear on the same physical entity. Section [4.13.2](#) defines the element strings that mandate the appearance of another element string on the same physical entity. All other combinations of element strings are possible at the first level of verification, although they may not make sense at the second, the application level.

4.2 GTIN rules

4.2.1 Management of uniqueness

Global Trade Item Numbers (GTINs) must be allocated uniquely. GTINs SHOULD NOT contain any intelligence or parsable strings. The embedding of internal codes is discouraged because it is often found that the rules for changing them differ from the rules for changing a GTIN.

For some product types (e.g., healthcare items) it is common for national regulators to require the submission of a product filing from a party based within the jurisdiction of the regulator. Such arrangements have no direct impact on GTIN Management but need to be covered by the normal contractual arrangements (e.g., licenced distributor, subsidiary, reseller).

4.2.2 Allocating the numbers

A Global Trade Item Number (GTIN) is used to identify any trade item (product or service) upon which there is a need to retrieve predefined information and that may be priced or ordered or invoiced at any point in any supply chain. A separate, unique GTIN is required whenever any of the trade item declarations are different in any way that is relevant to the trading process.

The details on when to change a GTIN are included in the Global Trade Item Number (GTIN) Management Standard. This standard is designed to help industry make consistent decisions about the unique identification of trade items in open supply chains. The [GTIN Management Standard](#) defines when GTIN changes are needed at the retail consumer trade item level (base unit) as well as on higher level trade items (e.g., case, pallet) that currently exist and are used in distribution processes.

The [GTIN Management Standard](#) as well as specific standard rules that apply to upstream, fresh foods, healthcare and other specific sectors can be found at <https://www.gs1.org/1/qtinrules/en>.

Local, national or regional regulations may require more frequent GTIN changes. Such regulations have precedence over the rules provided within the [GTIN Management Standard](#).

4.2.2.1 GTIN Management definitions

The following terms may be useful when reviewing the [GTIN Management Standard](#) that is published on <https://www.gs1.org/1/gtinrules/en>:

- **Logistic unit** – An item of any composition established for transport and/or storage that needs to be managed through the supply chain. It is identified with an SSCC (Serial Shipping Container Code).
 - **Retail consumer trade item** – The trade item intended to be sold to the end consumer at retail point-of-sale. They are identified with a unique GTIN-13, GTIN-12, or GTIN-8. (See section 2).
 - **Retail consumer trade item variant** – A change to a retail consumer trade item (which may itself be a homogeneous or a physical trade item assortment/bundle of other retail consumer trade items) that does not require a new GTIN, but where identification of the variation may be required.
 - **Trade item** – Any item (product or service) upon which there is a need to retrieve predefined information and that may be priced, ordered, or invoiced at any point in any supply chain.
 - **Trade item grouping** – A grouping of retail consumer trade items that is not intended for point-of-sale scanning. It is identified with a unique GTIN-14, GTIN-13, or GTIN-12.
- ✔ **Note:** The [GTIN Management Standard](#) is intended for global use. Exceptions may occur only when local regulatory or legal requirements mandate otherwise.
- ✔ **Note:** The exchange of product data across global supply chains requires compliance with rules for product identity and data attribution. It is recommended that all retail consumer trade items are registered with [GS1](#). For more information see your [GS1 Member Organisation](#).

4.2.2.2 Trade item declarations

Trade item declarations are the set of all information about a trade item (e.g., manufacturer warranty, ingredients, instructions for use, specifications, contents, certifications). For a trade item, this is all of the information that is on the label and in the original packaging. It also includes relevant aspects of the extended packaging.

Although this list is not exhaustive, the basic trade items declarations are:

- The primary brand or, as may be defined by regulation, the product name and/or product description.
- The trade item type and variety.
- The net content of trade item and/or net weight, volume, or other dimension impacting trade.
- If the trade item presents a grouping, the number of elementary items contained and their subdivision in sub-packaging units.
- For a predefined trade item assortment/bundle, the composition of the trade item assortment/bundle.

A modification to any of the basic elements that characterise a trade item will usually lead to a change in the Global Trade Item Number (GTIN).

- ✔ **Note:** These rules are intended for global use. Exceptions may occur only when local regulatory or legal requirements mandate otherwise. For example, in some industries, such as healthcare, regulations or other requirements may dictate that any trade item changes require a new GTIN.

- ✔ **Note:** If a party adapts, refurbishes, or modifies trade items see section [2.1.15](#) for information on identifying non-new trade items.

- ✔ **Note:** For complex products, such as some medical devices, key consideration for GTIN allocation is the commercialisation of the product (e.g., different for pricing or ordering or invoicing). If the product is 'different' a 'different GTIN' is required. The figure below is a scenario to represent the difficulties in determining when a GTIN change is necessary for complex medical devices, depending upon how the device is viewed (i.e., from a commercial and/or form, fit, function perspective). Nominally the commercial aspects of an item determine a GTIN change, the objective is to recognise that other important factors reside which may not necessarily signify a commercialisation shift, but would impact the GTIN assignment – particularly in the healthcare industry. It is the brand owner's responsibility to manage appropriately the configuration of any complex device and its appropriate GTIN(s) assignment. The example shows major hardware components managed by GTIN and serial number combinations, recognising that within this complex medical device there are other potential parameters where configuration change must be managed; GTIN change may be dictated based on the manufacturers change management process. It is the brand owner that decides upon the identification requirement.

Figure 4.2.2-1. Example of the complexity of a medical device product with regard to GTIN allocation

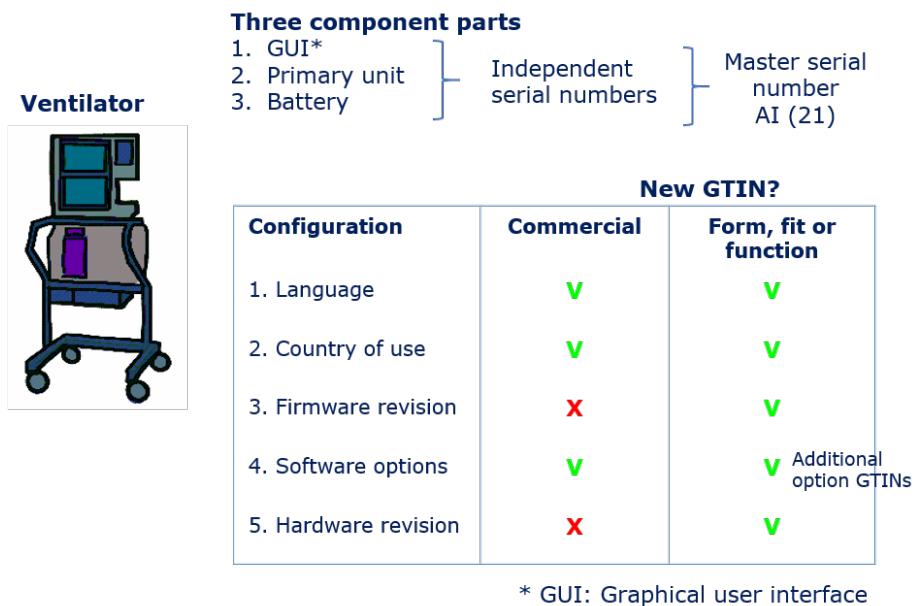

4.2.2.3 Trade item variants

4.2.2.3.1 Consumer product variants

Per brand owner discretion, a consumer product variant (CPV) if used, SHALL be used with GTIN on retail consumer trade items in the following conditions:

1. A CPV may be assigned by the brand owner to a variation of a retail consumer trade item, which SHALL NOT require a new GTIN per the [GTIN Management Standard](#), but where communication regarding the variation may be required.
2. Each retail consumer trade item variation SHALL NOT have more than one CPV value.
3. CPV may be assigned to retail consumer trade items that contain a homogeneous quantity or predefined assortment of retail consumer trade items.

4. When a retail consumer trade item is offered in different quantities (e.g., unit, six pack, 12 pack) the various packages for these quantities are each identified with a unique GTIN. Those packages may also each include a unique CPV and the actual data value for the CPV may or may not be the same between the various packages.
5. The CPV of a retail consumer trade item that contains a homogeneous quantity or predefined assortment of retail consumer trade items may change independently from the CPV of the contained retail consumer trade items, but shall change if the CPV of any of the contained retail consumer trade item changes.

4.2.2.3.2 Minor trade item variants for trade item groupings

For trade item groupings containing units that are themselves minor trade item variants of trade items whose GTINs remain unchanged, the rule is the following:

- If the identification of minor trade item variants is only relevant to the manufacturer, they SHOULD distinguish these variants by using the element string internal product variant, AI (20). Examples include an identical product made in two separate locations or the same product with a minor package design change.

4.2.3 Responsibility for allocating the Global Trade Item Number

The established terminology of the GS1 system may not be familiar to all industries that use the GS1 system. As of release 23 of the *GS1 General Specifications*, a broader terminology framework is used to enable industry to consistently and accurately identify the party that has the responsibility to allocate/assign the GTIN.

- ✔ **Note:** The term GTIN allocator is used to broadly and consistently refer to the party responsible for allocation of GTINs to trade items (defined in [4.2.3.1](#)). This term is harmonised with the historical use of the term brand owner below.

There are foundational rules for the assignment of GTINs to trade items that apply in all scenarios:

- A trade item SHALL be assigned a GTIN before there is an offer made for sale of the trade item.
- GTIN is to be assigned at the earliest point in any trade item's lifecycle after which a GTIN allocator has been established.
- No downstream party (e.g., distributor, wholesaler, importer, merchant) may assign a different GTIN to a trade item that already has a GTIN, provided that the trade item is not changed in a way that would require a new GTIN as per GS1 standards (see [GTIN Management Standard](#)).
- When a GTIN is assigned to a trade item by a downstream party, the same GTIN may not be assigned to any trade item by any other party.

4.2.3.1 Responsibility for branded items

Allocation of a GTIN to a trade item is the responsibility of the party that warrants the trade item declarations, known as the GTIN allocator (see [4.2.2.2](#) for more on trade item declarations).

Prior to release 23 of the *GS1 General Specifications*, the party responsible for allocation of a GTIN to a trade item was referred to as the "brand owner". In industries where the term "brand owner" is relevant and familiar, this term SHALL be considered as equivalent to the term GTIN allocator.

For branded items, the brand owner is the GTIN allocator, since the brand owner is the party that owns the specifications of the trade item, and, therefore is the party that warrants the trade item declarations.

There are situations when the GTIN allocator is:

- The manufacturer or supplier: The party that manufactures the trade item or has it manufactured, in any country.

- The importer or wholesaler: The party that sells the trade item under its own brand name or the importer or wholesaler that changes the trade item (for example by modifying the packaging of the trade item).
- The retailer: The retailer that sells the trade item under its own brand name.
- Any party that chooses to take responsibility for the trade item declarations of a trade item that has not yet been assigned a GTIN and, in doing so, sells it under their own brand name.

In all cases, the party who warrants the trade item declarations is the party who SHALL assign the GTIN to a trade item. With that action, the party becomes the GTIN allocator.

- ✔ **Note:** A GTIN allocator is licenced a GS1 Company Prefix and/or individual GS1 identification keys by a GS1 Member Organisation. GS1 Company Prefixes and individual GS1 identification keys are allocated by the company to which they are assigned.

4.2.3.2 Unique scenarios

There are some unique scenarios to the rules regarding responsibility for GTIN allocation described section [4.2.3.1](#):

- **Non-branded items:** The GTIN allocator for trade items without a brand name and generic items (not private labels) SHOULD be the manufacturer of the non-branded item. Different manufacturers and/or suppliers may supply non-branded items that are similar or identical to a buyer (who could be a customer, a merchant or a manufacturer). Companies that trade in these items need to organise their computer applications (e.g., replenishment programs) to cope with this eventuality. If a brand is applied to a non-branded item, the [GTIN Management Standard](#) SHOULD be consulted for GTIN management rules.
- **Customer specific items:** If a trade item is made specifically for one trade customer and is orderable only by this customer, then the customer SHOULD be the GTIN allocator. The GTIN SHOULD be created from the customer's GS1 Company Prefix or SHOULD be an individual GTIN identification key from the customer (see section [1.4.4](#)). If the supplier (merchant) sells a trade item to more than one customer, then the merchant SHALL be the GTIN allocator.
- **Contracted parties:** If a party is contracted to act on behalf of, or to represent, a GTIN allocator, a trade item created by the contracted party for the GTIN allocator SHALL be assigned a GTIN from the GTIN allocator's licenced GS1 Company Prefix or individual GS1 keys. In such situations, it is critical to ensure that such contracts include language that ensures all allocated GTINs are properly registered and managed by the GTIN allocator.
- **Other exceptions:** If a trade item does not have a GTIN, a downstream party may choose to take responsibility for the trade item declarations and become the GTIN allocator for the trade item subject to compliance with any relevant laws. Alternatively, a downstream party can assign an internal number (e.g., RCN) to a trade item that does not have a GTIN assigned to it, but only if the trade item is restricted for use within its own stores/platform.

4.2.4 Sector-specific rules

4.2.4.1 GTIN allocation rules for healthcare

Specific rules that apply to healthcare trade items can be found in the [GS1 Healthcare GTIN Allocation Rules Standard](#).

4.2.4.2 GTIN allocation rules for upstream suppliers

Specific rules that apply to packaging and raw material trade items supplied to manufacturing companies can be found on <https://www.gs1.org/1/gtinrules/en/tree/29/upstream>.

Upstream suppliers are those companies that typically supply or manufacture trade items that are supplied to other companies for further processing. Examples of these trade items include raw ingredient and packaging materials.

A Global Trade Item Number (GTIN) must be assigned to each predefined trade item and any unit of measure used in the price, order, or invoice process.

- ✔ **Note:** These rules are intended for global use. Exceptions may occur only when local regulatory or legal requirements mandate otherwise.

4.2.4.3 GTIN allocation considerations for apparel and home fashion

The GSMP General Merchandise Work Team validated the original Global Trade Item Number (GTIN) allocation rules and concluded that they are applicable to the apparel and home fashions product category. The content of this section extends the content in section 4.2 to cover scenarios specific to apparel and home fashions and may be different in other sectors. This section is the result of the review of the Trade Item Identification and Communication Guidelines (VICS EDI) TIIC, May 2001, by the GSMP Work Team.

4.2.4.3.1 Pre-pack/multi-pack/set-pack

For a pre-pack or assortment of trade items, each different item within the pre-pack will be assigned a GTIN maintaining the one-to-one relationship between trade item/colour ID/size ID and GTIN. Each GTIN must be marked so as to enable scanning at the point-of-sale. A separate, unique GTIN is assigned to each orderable pre-pack. This GTIN is not intended to be scanned at the retail point-of-sale. Different pre-packs of trade items are assigned different GTINs when either the component item or quantity contents of the pre-packs are different.

A multi-pack is a group of trade items (the same or different) that are intended to be sold as a single consumer unit at the point-of-sale (e.g., a three-pack of men's white T-shirts or a 12-piece set of glassware). A multi-pack is not intended to be broken apart and sold as individual trade items. A multi-pack is assigned a GTIN that is different from the GTIN that may be assigned to the individual trade items. Generally, components of a multi-pack are not marked with individual GTINs. Each different multi-pack of the same trade items (e.g., three-pack socks versus six-pack socks) must have a different GTIN assigned. Each different multi-pack GTIN must also have its own trade item/colour ID/size ID.

For a set-pack, each different trade item within the set-pack will be assigned a GTIN, maintaining the one-to-one relationship between trade item/colour ID/size ID and the GTIN. The individual trade item GTIN must be marked to enable retail point-of-sale scanning and may or may not be orderable separately outside the set-pack(s). A separate, unique GTIN is assigned to each set-pack. Different set-packs are assigned different GTINs when either the trade item or quantity contents are different. The figure below provides a summary of the requirements.

Figure 4.2.4.3.1-1. Requirements by pack type

Pack	Individual items of the pack					
	Orderable by retailer	Sellable to consumer	GTIN marked	Orderable by retailer	Sellable to consumer	GTIN marked
Pre-pack	Yes	No	Yes	Maybe	Yes	Yes
Multi-pack	Yes	Yes	Yes	No	No	No
Set-pack	Yes	Yes	Yes	Maybe	Yes	Yes

- ✔ **Note:** GTINs on individual trade items in a multi-pack are optional.
- ✔ **Note:** GTINs on individual trade items in a set-pack are required because the individual pieces are available for sale to the consumer.
- ✔ **Note:** Individual components of pre-packs and set-packs may be ordered separately based on individual partnership agreement.

4.2.4.3.2 Gift with purchase/purchase with purchase/collateral item

A gift with purchase is a trade item given to a consumer as part of a promotional event, contingent on the consumer making a purchase of another item or items. A gift with purchase is considered inventory and has no retail value.

A purchase with purchase is a trade item sold to a consumer at a special price as part of a promotional event, contingent on the consumer purchasing another item or items. A purchase with purchase is considered inventory and has a retail value. When assigning and tracking Global Trade Item Numbers (GTINs) for gift with purchase and purchase with purchase trade items, GTINs SHOULD be assigned to all gift with purchase and purchase with purchase items and be marked with a GTIN to enable point-of-sale scanning.

A collateral item is a trade item delivered from a manufacturer to the retail selling floor that is not considered inventory and has no retail value (e.g., a display case that needs to be identified but has no retail value). GTINs SHOULD be assigned to all collateral items.

4.2.4.4 GTIN allocation considerations for direct marking

The master data linked to the GTIN marked on the item (see section [2.6.14](#)) will generally apply for the item at time of production and first purchase. The master data will no longer apply when changes are made to the trade item (refurbishment, upgrade, memory extension, etc.). When such changes are made the GTIN as marked on the item MAY remain the same, and companies will need to ensure that it is clear to all parties which master data may change over time.

4.2.5 GTIN non-reuse

An allocated GTIN SHALL NOT be reallocated to another trade item. The only exceptions are:

- The GTIN may be deleted from all catalogues without first being marked as withdrawn or discontinued and may be reused 12 months after it is deleted or after it is last shared with a trading partner (whichever is later) if both:
 - the GTIN is published in an externally accessible manner (e.g., to a catalogue or directly to a trading partner) with a status that indicates that it is draft, preliminary, investigational, or some equivalent status other than final, withdrawn, discontinued, or deleted; and
 - the trading partners with whom the GTIN is shared agree that it may be reused, either as a condition of receiving the data (e.g., the GTIN is sent to the trading partners as part of an investigational product development phase) or after deletion (e.g., all trading partners confirm that the draft, preliminary, or investigational GTIN has not been propagated to a system that would be adversely affected by reuse of the GTIN).
- If the GTIN is never published in an externally accessible manner (e.g., to a catalogue or directly to a trading partner), it may be reused immediately.
- Trade items that have been withdrawn from the market and are reintroduced may use the original GTIN if they are reintroduced without any modifications or changes that require a new GTIN as specified by the [GTIN Management Standard](#).

 **Note:** The GTIN non-reuse rule went into effect on 1 January 2019 in response to digital business demand. GTINs discontinued and withdrawn from the market prior to 1 January 2019 may be considered for reuse one final time (*). However, companies are strongly advised to follow the non-reuse rule for **all** GTINs to avoid risks of conflicting data.

(*) If a GTIN was withdrawn prior to 1 January 2019, the previously applicable rules must be adhered to (see section [4.16.1 Deprecated GTIN reuse rules](#)).

4.2.6 Data alignment

When a new Global Trade Item Number (GTIN) is assigned to a trade item, it is essential that the brand owner provide the detailed information to trading partners about the item's characteristics. This information should be provided at as soon as possible before the trade item is actually traded.

Expediting GTIN information to buyers reduces order exception handling and reduces the lead time in getting goods to the selling floor.

4.2.6.1 Data alignment best practice

A number of actions are vital to ensure that Global Trade Item Numbers (GTINs) are accurately communicated within the supply chain. These ensure that the data associated with any scanned barcode can be associated with accurate, up-to-date data. This is particularly essential for items scanned at the point-of-sale where the absence of accurate data may have legal implications.

The GTIN provides a supply chain solution for the identification of any item that is traded (priced, invoiced, or ordered). Overall supply chain costs are minimised by all partners in the supply chain adhering to identical [GTIN Management Standards](#) (see section [4.2.2](#)).

The following best practices are proposed for all items. It has been developed by manufacturers, distributors and retailers to help eliminate any confusion between product identification and product listing in the retailer's database in the supply chain.

1. GTIN Management and the barcoding of the GTIN are technical processes with rules detailed in these *GS1 General Specifications*. Product listing is the act of adopting a new product in an assortment by a commercial organisation. Product listing is the result of commercial negotiations between purchaser and seller. For example, GTIN Management should be independent from product listing.
2. For management reasons, or to ensure that correct information is communicated to the final consumer, changes to an item may require a new GTIN. A new GTIN does not automatically imply a new listing. For example, if a change requiring a new GTIN is made to a listed product, this should not automatically imply a new product listing is needed.

GTIN Management and database listing are to be considered as two entirely autonomous decisions: GTIN Management is not an object of negotiation.

The brand owner makes available to its client all information regarding the listed items, ideally with an EDI message or in an e-product catalogue, no later than at the time of item listing. In case of time limited promotions or a product evolution, this information will be communicated largely beforehand, thus allowing the retailer to validate this information and to circulate it internally.

4.2.7 GTIN-8 guidelines and packaging size constraints

Before deciding to use a GTIN-8 as opposed to a GTIN-13 or GTIN-12, companies, working jointly with their printer, should consider options such as:

- Whether the barcode can be reduced in size; e.g., printed at a lower X-dimension, taking into account the minimum barcode print quality requirements (see section [5.12](#)).
- Whether the label or artwork can reasonably be changed to enable the inclusion of an EAN-13 or a UPC-A barcode or a symbol from the GS1 DataBar Retail POS family.
- For example, redesigning the label and increasing the label size may be an option, especially when the existing label is small in comparison with the pack area.
- Whether a truncated barcode can be used.

 **Note:** A truncated barcode (normal length, but reduced in height) may only be used if there is absolutely no possibility of printing a full size barcode. Truncation removes the omnidirectional scanning capability. A barcode with excessive truncation will not be of any practical use. Users considering this option should consult their customers to see if an acceptable compromise can be reached.

Packaging size constraints

The use of a GTIN-8 is authorised when:

- The total printable area of the product packaging is less than 80 cm², or
- The area of the largest label for the item is less than 40 cm², or

- The product is cylindrical with a diameter less than 30 mm.

Figure 4.2.7-1. GTIN-8 packaging size constraints

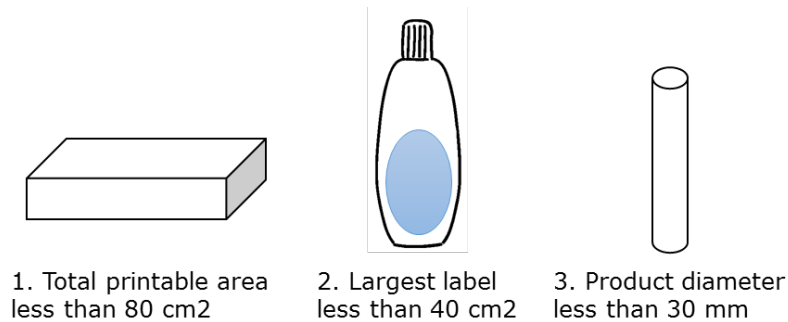

4.3 SSCC rules

4.3.1 Allocating Serial Shipping Container Codes

4.3.1.1 General rule

An individual Serial Shipping Container Code (SSCC) is a unique number, which remains the same for the life of the logistic unit to which it is assigned. When assigning an SSCC, the rule is that an individual SSCC number must not be reallocated within one year of the shipment date from the SSCC assignor to a trading partner. However, prevailing regulatory or industry organisation specific requirements may extend this period.

4.3.1.2 Responsibility

The Serial Shipping Container Code (SSCC) provides functionality to support the management (tracking, tracing, storage, etc.) of logistic units through the supply chain. To ensure global uniqueness and traceability, the physical builder of the logistic unit or the brand owner of the logistic unit is responsible for the allocation of the SSCC.

4.3.2 Aggregated/nested logistic units

Logistic units may be aggregated or nested into other logistic units for part of the journey to the final destination. For example, parcels may be combined onto pallets. In that case the SSCC of the higher logistic unit may be used to track and trace the contained logistic units. GS1 EDI and EPCIS support the electronic communication of such aggregations or nestings by enabling to specify links between the child SSCCs and parent SSCC.

When dealing with aggregated/nested logistic units in AIDC applications, the following rules apply to ensure correct identification of the higher logistic unit:

- Only the barcode of the higher logistic unit SHOULD be readable. The barcodes of the lower level logistic units should be obscured or otherwise prevented from being read (e.g., by instructing those scanning through a standard operating procedure).
- When using EPC/Rfid tags, the filter value used for the higher logistic unit SHALL be different from the filter value used for the lower logistic units.

✓ **Note (informative):** See the *GS1 Logistics Label Guideline*⁴ for examples of the way to deal with nested/aggregated logistic units.

⁴ https://www.gs1.org/docs/tl/GS1_Logistic_Label_Guideline.pdf

4.4 Rules for GS1 asset identifiers

4.4.1 General rule

4.4.1.1 GS1 asset identifiers

GS1 asset identifiers can be used to identify any fixed assets of a company. It is left to the discretion of the issuer to determine whether the Global Returnable Asset Identifier (GRAI), AI (8003), or Global Individual Asset Identifier (GIAI), AI (8004), is more suitable for the application concerned.

4.4.1.2 Lead time in reusing GS1 asset identifiers

Asset identifiers must not be used for any other purpose and must remain unique for a period well beyond the lifetime of the relevant records. If a company assigns asset identifiers to trade items supplied to its customers, the company must ensure that the asset identifiers are never reused.

All issuers of asset identifiers must ensure that asset identifiers (GRAIs, GIAIs) allocated for medical devices/equipment used for treatment of a patient SHALL NOT be reused.

Also, GIAIs that are marked directly on safety critical components and parts, such as used in rail, SHALL NOT be reused.

4.4.1.3 Responsibility

The asset owner or manager is responsible for the issuance and allocation of GS1 asset identifiers.

 **Note:** The term 'asset manager' includes manufacturers that issue and allocate asset identifiers to be used during the full lifetime of the asset. Furthermore, best practices may dictate that the trade item manufacturer applies the asset identifiers issued by the asset owner or manager during the manufacturing process (see section [2.3](#)).

4.4.2 Allocating Global Returnable Asset Identifiers (GRAIs): AI (8003)

The structure of the element string for a Global Returnable Asset Identifier (GRAI) can include two parts: the mandatory identification of an asset type and an optional serial component, to distinguish individual assets within the same asset type (see section [2.3.1](#))

Figure 4.4.2-1. Format of the element string

GS1 Application Identifier	Lead zero	Global Returnable Asset Identifier (GRAI)			
		GS1 Company Prefix →	Asset type ←	Check digit	Serial component (optional)
8 0 0 3	0	N ₁ N ₂ N ₃ N ₄ N ₅ N ₆ N ₇ N ₈ N ₉ N ₁₀ N ₁₁ N ₁₂		N ₁₃	X ₁ variable X ₁₆

The exact method used to allocate the GRAI is left to the discretion of the issuing organisation. However, a unique number, the asset type, must be assigned for each type of asset being identified, and for ease of administration, the GS1 system recommends that numbers be allocated sequentially and not contain classifying elements.

When it is not possible to assign an asset type (e.g., for museum exhibits), or when the type of asset is not required by the application (e.g., when the item is only used for a single type of asset), then the Global Individual Asset Identifier (GIAI), AI (8004), SHOULD be used.

When using AI (8003), a leading zero SHALL be required before the GRAI.

4.4.2.1 Identical assets identification

A single Global Returnable Asset Identifier (GRAI) SHOULD be assigned to a series of identical assets.

Figure 4.4.2.1-1. Examples of GRAI excluding serial component

Asset type	GRAI ¹
50 litre aluminium beer keg	1234567890005
10 litre aluminium beer keg	1234567890012
10 litre wooden beer keg	1234567890029
Note: (1) The leading zero required before the GRAI when used with AI (8003) is not required when displayed as non-HRI text.	

4.4.2.2 Serial component (optional)

The asset owner or manager assigns the optional serial component. It denotes an individual asset within a given asset type. The field is alphanumeric and is used to distinguish individual assets with the same asset types.

Figure 4.4.2.2-1. Examples of GRAI including serial component

Asset Type	GRAI (incl. the serial component) ¹
50 litre aluminium beer keg	12345678900051234AX01
50 litre aluminium beer keg	12345678900051234AX02
50 litre aluminium beer keg	12345678900051234AX03
Note: (1)The leading zero required before the GRAI when used with AI (8003) is not required when displayed as non-HRI text.	

4.4.3 Allocating Global Individual Asset Identifiers (GIAIs): AI (8004)

The Global Individual Asset Identifier (GIAI) is structured according to the figure below.

Figure 4.4.3-1. Format of the element string

GS1 Application Identifier	Global Individual Asset Identifier (GIAI)			
	GS1 Company Prefix		Individual asset reference	
8 0 0 4	N ₁ ...	N _i	X _{i+1} ...	variable length X _j (j<=30)

The exact method used to allocate the GIAI is left to the discretion of the issuing organisation. However, each GIAI must be unique for each individual asset being identified and, for ease of administration, the GS1 system recommends that GIAIs be allocated sequentially and not contain classifying elements.

4.4.4 Change of asset ownership

Asset identification numbers are used in a diverse range of business applications ranging from tracking the movements of reusable packaging trays to recording the life cycle history of aircraft parts. If a company sells an asset to another company then the asset identifier SHOULD ideally be replaced by another Global Individual Asset Identifier (GIAI) or Global Returnable Asset Identifier (GRAI) or be removed. It is permissible for the asset identifier to remain on the item when the ownership changes if the new owner takes responsibility for the GS1 Company Prefix associated with the asset identifier, or when the asset identifier was assigned by the manufacturer. For further information regarding changes of ownership, please refer to section [1.6](#).

4.4.5 Information associated with asset identifiers

The data related to the asset should be recorded and shared digitally using the asset identifier as the key to the information. Examples of the type of information held include the GLN of the party

who owns or manages the asset, the value of the asset, the location of the asset and the life cycle history of the asset.

4.5 GLN rules

4.5.1 Allocating Global Location Numbers

4.5.1.1 Allocation general rule

A separate, unique GLN is required to be allocated whenever there is a need to distinguish one party and/or location from another. (e.g., each store location is required to have a separate GLN to identify the physical locations).

GLNs SHALL be allocated by the party that defined the party/location in support of their business operations.

The below defines which party is responsible for allocating the GLN to a legal entity, function, physical location, or digital location. If a GLN is used to identify a combination of legal entity, function, physical location and/or digital location, all applicable rules SHALL apply.

- **Legal entity:** Allocating a GLN to a legal entity is the responsibility of the legal entity itself or another legal entity that is part of the same organisation. If multiple legal entities within an organisation have licensed GS1 Company Prefixes or individual GLNs, the parties SHOULD coordinate GLN allocation.
- **Function:** The organisation identifying their own, internal functions to support their business operation is responsible for allocating GLN.

When representing itself as a legal entity or function in transactions, an organisation SHALL only use GLNs for which it has appropriate licences. This means that an organisation SHALL NOT use a GLN from another organisation's licence to represent itself as a party.

- **Physical location:** The owner or primary user(s) of the physical location is responsible for allocating the GLN.
 - When a party allocates a GLN to a location they do not own, that party SHOULD inform the owner and/or primary users of the location.
 - Parties SHALL use a GLN allocated by their own organisation, the owner of the location, or a primary user that is a business partner directly involved in a specified transaction. A party SHALL NOT use a GLN allocated by an organisation that does not directly relate to their business relationships.
- **Digital location:** The owner or primary user(s) of the digital location is responsible for allocating the GLN.

- ✓ **Note:** The owner is the organisation that has the legal or rightful title to the physical or digital location. A primary user is an organisation that directly transacts with a physical or digital location. There may be multiple primary users associated to a single location.

Example: an owner would be the organisation that has legal ownership of a mall. A primary user would be the organisation that is leasing a space within the mall for their retail store.

When allocating a GLN, an organisation SHOULD:

1. Verify that the party and/or location is not already identified by a GLN.
2. Associate master data for the identified party/location to the GLN (see section [4.5.3](#)).
3. Communicate the GLN and associated data to trading partners in a timely manner.

The GLN allocated to a party/location SHOULD be communicated to partners by the organisation that allocated the GLN in advance of a transaction/delivery so that all systems can be prepared for the interaction. See section [4.5.2](#) for additional details.

Individual companies need to determine how they allocate GLNs. An organisation may use a single GLN for order, delivery and invoice because each process is undertaken at the organisation (legal entity) level. However, an organisation may also allocate distinct GLNs to locations and functions within its organisation.

See the [GS1 GLN Allocation Rules Standard](#) for management rules and scenarios defining when a GLN SHOULD be allocated to a new party/location or as the result of a change.

- 
Note: These rules are intended for global use. National, federal or local regulations may take precedence. Examples include regulations affecting a company's registration, taxation, or fiscal obligations, as well as its industry requirements.

4.5.1.2 Party/location without Global Location Number

When a party/location needs to be identified by a GLN, the organisation defining the party/location in support of their business operations SHALL allocate the GLN. See section [4.5.1.1](#) for details.

If the organisation does not have a GS1 Company Prefix, it must either request a GS1 Company Prefix or an individual GLN from a GS1 Member Organisation. A GLN SHALL NOT be sold, leased, or loaned to a separate party.

- 
Note: GS1 Member Organisations offer various alternatives by which a company can obtain its own GLN.

4.5.1.3 Assigning GLN values



GLNs SHOULD be allocated without any classifying elements.

There is no need to coordinate GS1 identification key values across different GS1 identification keys. This is true even when the keys have an identical format. For example, there is no risk of conflict when a GTIN-13 and a GLN have the same value: GS1 Application Identifiers, data qualifiers and XML tags (EDI) prevent misinterpretation.

While companies may place GLNs in logical groupings for internal purposes, there are no supply chain standards to do so. GLNs are assigned at the discretion of GS1 user companies to support their business applications. Any additions or deletions from the group do not impact individual GLN allocation.

4.5.2 GLN non-reuse

An allocated GLN SHALL NOT be reallocated to another party and/or location. The only exceptions are:

- 
 If the GLN was never published in an externally accessible manner (e.g., to a registry or directly to a trading partner), it may be reused immediately
- 
 Parties and/or locations that have been withdrawn and are reintroduced may use the original GLN if they are reintroduced without any modifications or changes that require a new GLN as specified by the GS1 GLN Allocation Rules Standard

The GLN non-reuse rule went into effect on 1 July 2022. GLNs discontinued and withdrawn from systems prior to 1 July 2022 may be considered for reuse one final time (*). However, companies are strongly advised to follow the non-reuse rule for **all** GLNs to avoid risks of conflicting data.

(*). If a GLN was withdrawn prior to 1 July 2022, the previously applicable rules must be adhered to (see section [4.16.2](#) *Deprecated GLN reuse rules*).

- 
Note: These rules are intended for global use. Exceptions may occur only when local regulatory or legal requirements mandate otherwise.

4.5.3 Information associated with a Global Location Number

GLNs are assigned to parties and locations to provide a key to access master data in a business process (e.g., order, invoice, deliver). For each GLN, master data will be assigned to support business processes.

Master data associated to a GLN SHOULD be established in a database, then the GLN may then be used to facilitate efficient communication of this information.

The information held for legal entities, functions, physical locations and digital locations may include but is not limited to name, address, bank details, certifications and contact details.

Information associated with each GLN is held internally by trading partners or on central databases. If the party or location changes and the details are not updated, communications or deliveries will go to the outdated information held on file. Therefore, it is essential for organisations to inform trading partners as soon as possible about new GLN assignments or changes to information associated with a GLN.

The GLN Management Rules that define what changes to a party or location require a new GLN are included in the [GS1 GLN Allocation Rules Standard](#). The GLN Management Rules are designed to help industry make consistent decisions about the unique identification of parties and locations and SHOULD be referenced when changes to parties, locations and the information associated to them occur.

Local, national or regional regulations may require more frequent GLN changes. Such regulations have precedence over the rules provided within the [GS1 GLN Allocation Rules Standard](#).

! **Important:** Identical postal addresses, geocoordinates, geoshapes or other representations of where something is, operates or can otherwise be reached can be associated to multiple GLNs.

4.6 GSRN rules

4.6.1 Allocating Global Service Relation Numbers

4.6.1.1 General rule

Global Service Relation Numbers (GSRNs) can be used to identify the service provider and/or service recipient in any service relationship. A separate, unique number can be issued, normally by the organisation offering the service to identify the service provider and/or the service recipient, to identify any given service relationship. Once assigned, the GSRN becomes a unique and universal reference that can be used by all parties involved in the service relationship.

A GSRN with either AI (8018) or AI (8017) are mutually exclusive, that is, a GSRN can only be assigned to a single role, recipient or provider, but not both.

4.6.1.2 Changes in a service relationship

From time to time the details related to a Global Service Relation Numbers (GSRNs) may change. The following are general cases that may occur if the circumstances under which the GSRN were originally set up change:

- If an organisation providing a service ceases trading (possibly because of liquidation), any GSRNs allocated by that organisation SHOULD be phased out. If the activity covered by the GSRN is transferred, the new organisation providing the service may continue to use existing GSRNs if it has taken over the GS1 Company Prefix of the original organisation providing the service; if not, the GSRN SHOULD be phased out and a new GSRN allocated using the new organisation's GS1 Company Prefix.
- If the range of services identified by a GSRN changes, the organisation that provides the service SHOULD change the details associated with the GSRN on the related computer file record. The assignment of a new GSRN is not required in this case.

- A GSRN used to identify a particular service relationship that has terminated SHOULD NOT be reallocated for a period well beyond the lifetime of the relevant records.

4.6.1.3 Recommendation for allocating Global Service Relation Numbers

The exact method used to allocate the Global Service Relation Number (GSRN) is left to the discretion of the issuing organisation. However, the GSRN must be unique for each individual service provider and for each individual service recipient and each must remain unique for a period well beyond the lifetime of the records relevant to the service relationship.

All issuers of Global Service Relationship Numbers (GSRNs) must ensure that GSRNs allocated for healthcare service providers and service recipients SHALL NOT be reused.

For ease of administration, GS1 recommends that GSRNs be allocated sequentially and not contain classifying elements.

4.6.1.4 Information associated with a Global Service Relation Number

Global Service Relation Number (GSRN) may be used as a standalone element strings where all information required is established on a computer file using the individual GSRN as the key to access the information. The type of information stored is determined by the nature of the service relationship. Typical information includes the service recipient's or provider's full name, address and details of the services received or rendered.

If the identification of a GSRN needs to be further qualified with a sequence indicator corresponding to specific encounters during a service relationship, a Service Relation Instance Number (SRIN), AI (8019), may be associated to the GSRN.

When a GSRN is encoded to a data carrier and applied to AIDC media (e.g., membership card or patient wristband), a Version Control Number (VCN), AI (7242) may be associated to the GSRN to enable distinction between different versions of the same identification, displayed on one or more of the same AIDC media type. For example, when AIDC media is needed for access control purposes, this distinction between versions can facilitate processes managed with a service providers system to validate current versions and deactivate previously issued versions of the AIDC media.

4.7 GDTI rules

4.7.1 Allocating Global Document Type Identifiers

The Global Document Type Identifier (GDTI) is used to identify any document for document control purposes. A separate, unique GDTI is required whenever any of the characteristics of a document are different in any way that is relevant to the business process. As a guiding principle, if the end user is expected to distinguish between documents and process them accordingly, each document SHOULD be allocated its own GDTI.

The Global Document Type Identifier (GDTI) is assigned by the document issuer. The GDTI is used as a key to access database information (normally held by the issuing organisation).

The same document type is used for all document classes that are issued with an identical purpose. This can then be used to reference the main characteristics of the document, such as:

- The exact right or obligation the document imposes.
- The document purpose (e.g., insurance policy, governmental paper, product image).

A different document type SHALL be used whenever the main characteristics of the document are different.

Example:

An application form for membership to an organisation would be identified with a specific document type and all filled forms would be uniquely identified through the serial component.

If the limits of the membership were to change (now subject to legal constraints) the document type shall change, to document the modification. Subsequent applications with the modified form would then be tracked through the serial component.

The identification of each individually issued document requires a unique serial component in addition to the document type. Any duplicates of the individually issued document SHOULD use the same serial component as the original. The serial component is optional and assigned by the document issuer and is unique in a series of documents issued under the same Document Type. Ideally the serial component SHOULD be sequentially allocated for each new document generated. The serial component is used to communicate detailed characteristics pertinent to the individual document such as:

- The name and address of the recipient
- The document details

The definition of main characteristics (identified with the document type) and detailed characteristics (identified with the serial component) is at the discretion of the document issuer.

All issuers of Global Document Type Identifiers (GDTIs) must ensure that GDTIs allocated for documents relevant to patient treatment/care SHALL NOT be reused.

4.7.2 GDTI change rules

If the function, type, or major content (determined by the document issuer) of the document changes, the document type identifier SHALL change.

The document issuer will determine if changes to the content of the document require changing the document type identifier, or adding or changing a serial component.

Embedded metadata changes do usually not impact the functionality of the document and are not considered content changes. These would not require a change in the GDTI.

4.8 GINC rules

4.8.1 Allocating Global Identification Numbers for Consignment (GINC)

4.8.1.1 General rule

An individual Global Identification Number for Consignment is a unique number, which remains the same for the life of a grouping of logistics or transport units to which it is assigned. When assigning a GINC, the rule is that an individual GINC number must not be reallocated within one year of the shipment date from the freight forwarder assigning the GINC to a transport. However, prevailing regulatory or industry organisation specific requirements may extend this period.

4.9 GSIN rules

4.9.1 Allocating Global Shipment Identification Numbers

4.9.1.1 General rule

An individual Global Shipment Identification Number (GSIN) is a unique number, which remains the same for the life of the grouping of logistics or transport units to which it is assigned. When assigning a GSIN, the rule is that an individual GSIN number must not be reallocated within ten years of the shipment date from the seller or third party logistics provider (sender) of the GSIN to a trading partner buyer (recipient) to comply with the regulations of the World Customs Organisation (WCO). For goods that circulate within one country (domestic transport), the period of reuse is based on either governmental, industry or the discretion of the seller (sender) of the goods.

4.10 CPID rules

4.10.1 Allocating Component/Part Identifiers

The exact method used to allocate the Component/Part Identifier (CPID) is left to the discretion of the issuing organisation.

4.11 GCN rules

4.11.1 Allocating Global Coupon Numbers

The exact method used to allocate the Global Coupon Number (GCN) is left to the discretion of the issuing organisation. However, the GCN must remain unique for a period well beyond the lifetime of the records relevant to the coupon. For ease of administration, GS1 recommends that GCNs be allocated sequentially and not contain classifying elements.

4.12 GMN rules

4.12.1 Allocating Global Model Numbers

Global Model Numbers can be used to identify base product designs or specifications from which trade items are derived and/or registered. The exact method used to allocate the GMN is left to the discretion of the brand owner. However, each GMN must be unique for each product model being identified and once assigned to one product model, SHALL NOT be reissued to identify another product model.

For regulated healthcare medical devices, the following applies:

Allocation of the Basic UDI-DI (GMN) is made per the discretion of the brand owner, but in compliance with regulatory rules.

4.12.1.1 Responsibility

The brand owner is responsible for the issuance and allocation of Global Model Numbers.

4.12.2 Information associated with Global Model Numbers

The data related to the product model SHOULD be recorded and shared using the Global Model Number as the key to the information. Examples of the type of information related to a GMN, may include the brand, certifications obtained, sewing pattern (e.g., in apparel sector), form / material/classification scheme (e.g., in construction sector), product line (e.g., in cosmetic sector). The following points highlight the relationship between GMN and GTIN:

- All GMN level attributes are common for all GTINs associated with it.
- Additional attributes across all GTINs associated with one GMN may not be common.

If any attribute defined for a GMN changes in a way that trading partners are expected to distinguish the changed or new product model from previous/current product model, a new GMN must be assigned. Since all GMN attributes are common for all associated GTINs, this also implies the change of these GTINs according to guiding principle 1 of the [GS1 GTIN Management Standard](https://www.gs1.org/1/gtinrules/en) (see <https://www.gs1.org/1/gtinrules/en>).

For regulated healthcare medical devices, the following applies:

Basic UDI-DI attributes are common for all GTINs (UDI-DIs) associated with it. The identifier can be attributed to GTINs (UDI-DIs) associated with it, in the UDI database (e.g., EUDAMED).

4.13 Data relationships

This section defines the rules for allowed combinations of element strings on the same physical entity, irrespective of the data carrier(s) applied to the entity. The rules are application-neutral, which means that they apply to all applications listed in section 2 and to any other application where multiple element strings are combined on the same physical entity.

The rules are presented in two tables:

1. Invalid pairs of element strings, indicating which combinations of element strings are not allowed on the same physical entity.
2. Mandatory pairs of element strings, indicating which element strings must occur in combination with one or more other element strings.

- ✔ **Note:** In both tables, the GS1 Application Identifiers (AIs) are used to indicate the element string. But when evaluating the rule the complete element string, i.e. the AI and the data field, needs to be taken into account.
- ✔ **Note:** GTINs encoded in an EAN/UPC and ITF-14 symbols are to be regarded as element strings prefixed by an inferred AI (01).
- ✔ **Note:** Duplicate element strings (e.g., two serial numbers, two batch/lot numbers, two Extended Packaging URLs) MAY appear on the same physical entity (for example in multiple barcodes). In that case they SHALL have the same value in each occurrence on that entity.

4.13.1 Invalid pairs of element strings

This section defines the pairs of element strings that SHALL NOT appear together on the same physical entity. The table does not provide a finite list of all possible rules, only situations that have proven to pose difficulties in practice are included.

Some explanation on figure [4.13.1-1](#):

- The table is sorted by AI value, with the lowest AI value displayed in the first column.
- Multiple AIs may be listed in the first or third column, separated by commas. This means that the same rule applies to all listed AIs.
- The rules work in both directions, e.g., if it states AI (01) SHALL NOT be combined with AI (37) this implies that AI (37) SHALL NOT be combined with AI (01).
- For the purpose of this table Made-to-Stock (MtS) GTIN AI (01) and Made-to-Order (MtO) GTIN AI (03) are simply referred to as GTIN.

Figure 4.13.1-1. Invalid pairs of element strings

Invalid pairs of element strings				Rule
AI	Designation	AI	Designation	
01	GTIN	01	GTIN	All occurrences of GTIN SHALL have one value. It is for example not allowed to include GTINs of other packaging levels.
01	GTIN	02	GTIN of contained trade items	GTIN of contained trade items is intended to list the trade items contained in a logistic unit and SHALL NOT be used to identify the contents of a trade item.
01	GTIN	03	GTIN	The same GTIN value SHALL NOT be used with AI (01) and AI (03) and a trade item identified with (01) GTIN SHALL NOT be identified by a MtO GTIN with AI (03).
01, 03	GTIN	37	Count of units contained	The count of units contained SHALL only be used with GTIN of contained trade items or trade item pieces.

Invalid pairs of element strings				Rule
AI	Designation	AI	Designation	
01	GTIN	255	Global Coupon Number	A trade item SHALL NOT also be identified as a coupon.
03	GTIN	02	GTIN of contained trade items	GTIN of contained trade items is intended to list the trade items contained in a logistic unit and SHALL NOT be used to identify the contents of a MtO trade item.
21	Serial Number	235	Third Party Controlled, Serialised Extension of GTIN	Only Serial Number or Third Party Controlled, Serialised Extension of GTIN SHALL be used with GTIN.
420	Ship to postal code, single postal authority	421	Ship to postal code with ISO country code	Only one ship to postal code SHALL be applied on the same physical entity.
421	Ship-to / Deliver-to postal code with three-digit ISO country code	4307	Ship-to / Deliver-to country code	Only one ship to country code SHALL be applied on the same physical entity.
422, 423, 424, 425	Country of origin, initial processing, processing, or disassembly	426	Country of full processing	Country of origin, initial processing, processing, or disassembly SHALL NOT be used in combination with country of full processing, since this would lead to ambiguous data.
390n	Amount payable – single monetary area	391n	Amount payable – with ISO currency code	Only one amount payable element string SHALL be applied on a payment slip.
390n	Coupon value	394n, 8111	Percentage discount of a coupon, Loyalty points of a coupon	The element strings coupon value, percentage discount of a coupon and loyalty points of a coupon SHALL NOT be applied in combination.
392n	Amount payable for a variable measure trade item – single monetary area	393n, 395n	Amount payable for a variable measure trade item and ISO currency code, Amount payable per unit of measure single monetary area (variable measure trade item)	Only one amount payable element string SHALL be applied on a variable measure trade item.
394n	Percentage discount of a coupon	8111	Loyalty points of a coupon	The element strings percentage discount of a coupon and loyalty points of a coupon SHALL NOT be applied in combination.
395n	Amount payable per unit of measure single monetary area (variable measure trade item)	8005	Price per unit of measure	The element strings Amount payable per unit of measure single monetary area (variable measure trade item) and Price per unit of measure SHALL NOT be applied in combination.
395n	Amount payable per unit of measure single monetary area (variable measure trade item)	392n, 393n	Applicable amount payable, single monetary area (variable measure trade item), Applicable amount payable with ISO currency code (variable measure trade item)	Only one amount payable element string SHALL be applied on a variable measure trade item.

Invalid pairs of element strings				Rule
AI	Designation	AI	Designation	
4330	Maximum temperature in Fahrenheit	4331	Maximum temperature in Celsius	Only a single maximum temperature SHALL be used in combination with an SSCC
4332	Minimum temperature in Fahrenheit	4333	Minimum temperature in Celsius	Only a single minimum temperature SHALL be used in combination with an SSCC
7250	Date of birth	7251	Date and time of birth	Only one date of birth SHALL be used
7256	Full name of person	7253, 7254, 7255, 7259	Family name of person, given name of person and name suffix of person, baby of family name	Either full name of person or a combination of family name of person, given name of person and name suffix of person SHALL be used.
7259	Baby of family name	7253, 7254, 7255, 7256	Family name of person, given name of person, name suffix of person, full name of person	Where the recipient of care identified by a GSRN is a baby, the name of the baby SHALL either be provided through AI (7259) (possibly in conjunction with AI (7258), to handle situations of multiple births) or through the combination of one or more of AIs (7253), (7254), (7255), (7256).
8006	ITIP	01	GTIN	The GTIN SHALL NOT be used in combination with the identification of an individual trade item piece. The GTIN of the trade item to which the individual trade item piece belongs is contained in the element string.
8006	ITIP	37	Count of units contained	The count of units contained SHALL only be used with GTIN of contained trade items or trade item pieces.
8018	GSRN for the recipient	8017	GSRN for the provider	Only one Global Service Relation Number (recipient or provider) SHALL be applied at one time for identification of an individual in a given service relationship
8026	Identification of a trade item piece contained in a logistic unit	02, 8006	GTIN of contained trade items, Identification of an individual trade item piece	Identification of the trade item piece contained in a logistic unit SHALL NOT be used in combination with GTIN of contained trade items or identification of an individual trade item piece.

4.13.2 Mandatory association of element strings

This section defines the element strings that mandate the appearance of another element string on the same physical entity.

- 
Note: This does not necessarily mean that the element strings need to appear in the same data carrier. For example, multiple GS1-128 barcode symbols may be used in combination on a GS1 Logistic Label.

The figure below reflects the use case requirements to date. Should future applications arise that require associations they will be added at that time.

Some explanation on figure [4.13.2-1](#):

- The table is sorted by AI value, with the AI that is the trigger for the rule displayed in the first column. This means that this table cannot be read in both directions. For example, a rule that states AI (17) must be used together with AI (01), does not imply that AI (01) can only be used together with AI (17), since it can also be used with other AIs.
- Multiple AIs may be listed in the first column, separated by commas. This means that the rule applies to all of the listed AIs (element strings).

- The same AI can occur in the first column multiple times, in different rows. This means that depending on the value of the element string different rules need to be applied.
- When multiple AIs are included in the third column, this is always done with an AND, OR or XOR logical operator between them:
 - AND means that all element strings SHALL appear on the physical entity
 - OR means that one or a combination of the element strings SHALL appear on the physical entity.
 - XOR means that one of the element strings SHALL appear on the physical entity and the other element string SHALL NOT.

Figure 4.13.2-1. Mandatory association of element strings

If element string		Then mandatory associated element string	Rule
AI	Designation	AI	
01 with N1 = 0	GTIN of a variable measure trade item scanned at POS	30 OR 3nnn*	The GTIN of a variable measure trade item scanned at POS SHALL occur in combination with: <ul style="list-style-type: none"> ■ variable count of items; or ■ a trade measure Note: Master data will be needed to determine whether the GTIN represents a variable measure trade item scanned at POS. Also see the note below this table.
01 with N1 = 9, 02 with N1 = 9	GTIN of a variable measure trade item not scanned at POS	30 OR 3nnn* OR 8001	The GTIN of a variable measure trade item not scanned at POS SHALL occur in combination with: <ul style="list-style-type: none"> ■ variable count of items; or ■ a trade measure; or ■ the dimensions of a roll product. Note: The first position of the GTIN is "9" for such trade items. Also see the note below this table.
01 with N1 = 9 or 03	GTIN of a custom trade item per section 2.6.8 or Made-to-Order GTIN (03)	Made-to-Order Variation Number AI (242)	The GTIN of a custom trade item using AI (01) and indicator digit "9" SHALL be used in combination with the Made-to-Order variation number. Note: The first position of the GTIN is "9" for such trade items. The Made-to-Order variation number MAY also be used with Made-to-Order GTIN using AI (03).
02	GTIN of contained trade items	00 AND 37	The GTIN of contained trade items SHALL occur in combination with an SSCC and the count of the trade items.
10	Batch/lot number	01 XOR 02 XOR 8006 XOR 8026 XOR 03 ***	Batch/lot number SHALL occur in combination with: <ul style="list-style-type: none"> ■ a GTIN; or ■ a GTIN of contained trade items; or ■ Identification of a Made-to-Order (MtO) trade item (GTIN): or ■ an ITIP; or ■ an ITIP of contained trade item pieces
11, 13, 15, 16, 17	Production date, packaging date, best before date, sell by date, expiration date (of a trade item)	01 XOR 02 XOR 8006 XOR 8026 ***	These dates SHALL occur in combination with: <ul style="list-style-type: none"> ■ a GTIN; or ■ a GTIN of contained trade items; or ■ an ITIP ■ an ITIP of contained trade item pieces
12	Due date	8020 AND 415	The due date SHALL occur in combination with the payment slip reference number and the GLN of the invoicing party
17	Expiration date (of a coupon)	255	The expiration date of a coupon SHALL occur in combination with the GCN.

If element string		Then mandatory associated element string	Rule
AI	Designation	AI	
20	Internal product variant	01 XOR 02 XOR 8006 XOR 8026 ***	Internal product variant SHALL occur in combination with: <ul style="list-style-type: none"> a GTIN; or a GTIN of contained trade items; or an ITIP an ITIP of contained trade item pieces
21	Serial number	01 XOR 03 XOR 8006***	The serial number SHALL occur in combination with: <ul style="list-style-type: none"> a GTIN; or Identification of a Made-to-Order (MtO) trade item (GTIN); or an ITIP Note: SGTIN is a common term for the combination of GTIN and serial number.
22	Consumer product variant	01	The consumer product variant SHALL occur in combination with a GTIN of a retail consumer trade item.
235	Third Party Controlled Serialised Extension of GTIN	01	The Third Party Controlled Serialised Extension of GTIN SHALL occur in combination with a GTIN of a trade item.
240	Additional product identification	01 XOR 02 XOR 8006 XOR 8026 ***	The additional product identification SHALL occur in combination with: <ul style="list-style-type: none"> a GTIN; or a GTIN of contained trade items; or an ITIP an ITIP of contained trade item pieces
241	Customer part number	01 XOR 02 XOR 8006 XOR 8026 ***	The customer part number SHALL occur in combination with: <ul style="list-style-type: none"> the GTIN; or the GTIN of contained trade items; or an ITIP an ITIP of contained trade item pieces
242	Made-to-Order variation number	(01 with $N_1 = 9$) XOR (02 with $N_1 = 9$) XOR (8006 with $N_1 = 9$) XOR (8026 with $N_1 = 9$) ***	The Made-to-Order variation number SHALL occur in combination with: <ul style="list-style-type: none"> the GTIN; or the GTIN of contained trade items; or an ITIP an ITIP of contained trade item pieces Note: The GTIN must relate to a custom trade item. The first position of the GTIN is "9" for such trade items.
243	Packaging Component Number	01	The Packaging Component Number SHALL occur in combination with the GTIN
250	Secondary serial number	(01 XOR 8006***) AND 21	The secondary serial number SHALL occur in combination with the serial number <u>and</u> : <ul style="list-style-type: none"> a GTIN; or an ITIP
251	Reference to source entity	01 XOR 8006***	The reference to source entity SHALL occur in combination with: <ul style="list-style-type: none"> a GTIN; or An ITIP
254	GLN extension component	414	The GLN extension component SHALL occur with the Identification of a physical location (GLN).
30	Variable count of items	01 XOR 02	The variable count of items SHALL occur with: <ul style="list-style-type: none"> a GTIN; or a GTIN of contained trade items. Note: The GTIN must relate to a variable measure trade item.

If element string		Then mandatory associated element string	Rule
AI	Designation	AI	
3nnn*	Trade measures	01 XOR 02	Trade measures SHALL occur in combination with: <ul style="list-style-type: none"> a GTIN; or a GTIN of contained trade items. Note: The GTIN must relate to a variable measure trade item.
3nnn**	Logistic measures	00 OR 01	Logistic measures SHALL occur in combination with: <ul style="list-style-type: none"> an SSCC a GTIN
337n	Kilograms per square metre	01	Kilograms per square metre SHALL occur in combination with a GTIN.
37	Count of units contained	00 AND (02 XOR 8026)	The count of units contained SHALL occur in combination with the SSCC and: <ul style="list-style-type: none"> GTIN of contained trade items, or ITIP of contained trade item pieces.
390n	Amount payable – single monetary area	8020 AND 415	The amount payable (single monetary area) SHALL occur in combination with the payment slip reference number and the GLN of the invoicing party.
390n	Coupon value – single monetary area	255	The coupon value (single monetary area) SHALL occur in combination with the Global Coupon Number.
391n	Amount payable – with ISO currency code	8020 AND 415	The amount payable (with ISO currency code) SHALL occur in combination with the payment slip reference number and the GLN of the invoicing party.
392n	Applicable amount payable - single monetary unit	01 AND (30 XOR 31nn XOR 32nn XOR 35nn XOR 36nn *)	The applicable amount payable (single monetary area) SHALL occur in combination with the GTIN and either: <ul style="list-style-type: none"> variable count of items; or a trade measure. Note: The GTIN must relate to a variable measure trade item.
393n	Applicable amount payable – with ISO currency code	01 AND (30 XOR 31nn XOR 32nn XOR 35nn XOR 36nn *)	The applicable amount payable (with ISO currency code) SHALL occur in combination with the GTIN and either: <ul style="list-style-type: none"> variable count of items; or a trade measure. Note: The GTIN must relate to a variable measure trade item.
394n	Percentage of a coupon	255	The percentage of a coupon SHALL occur in combination with the Global Coupon Number.
395n	Amount payable per unit of measure single monetary area (variable measure trade item)	01 AND (30 XOR 31nn XOR 32nn XOR 35nn XOR 36nn *)	The applicable amount payable per unit of measure (single monetary area) SHALL occur in combination with the GTIN and either: <ul style="list-style-type: none"> variable count of items; or a trade measure. Note: The GTIN must relate to a variable measure trade item.
403	Routing code	00	The routing code SHALL occur in combination with an SSCC.
415	GLN of the invoicing party	8020	The GLN of the invoicing party SHALL occur in combination with the payment slip reference number.
422	Country of origin	01 XOR 02 XOR 8006 XOR 8026 ***	The country of origin SHALL occur in combination with: <ul style="list-style-type: none"> a GTIN; or a GTIN of contained trade items; or an ITIP an ITIP of contained trade item pieces
423	Country of initial processing	01 XOR 02	The country of initial processing SHALL occur in combination with: <ul style="list-style-type: none"> a GTIN; or a GTIN of contained trade items.

If element string		Then mandatory associated element string	Rule
AI	Designation	AI	
424	Country of processing	01 XOR 02	The country of processing SHALL occur in combination with: <ul style="list-style-type: none"> ■ a GTIN; or ■ a GTIN of contained trade items.
425	Country of disassembly	01 XOR 02	The country of disassembly SHALL occur in combination with: <ul style="list-style-type: none"> ■ a GTIN; or ■ a GTIN of contained trade items.
426	Country of full processing	01 XOR 02	The country of full processing SHALL occur in combination with: <ul style="list-style-type: none"> ■ a GTIN; or ■ a GTIN of contained trade items.
427	Country subdivision of origin	(01 XOR 02) AND 422	The country subdivision of origin SHALL occur in combination with the country of origin <u>and</u> : <ul style="list-style-type: none"> ■ a GTIN; or ■ a GTIN of contained trade items.
430N	Ship-to / Deliver-to address GS1 Application Identifiers	00	Ship-to / Deliver-to address GS1 Application Identifiers SHALL occur in combination with an SSCC
4303	Ship-to / Deliver-to address line 2	4302 and 00	Ship-to / Deliver-to address line 2 SHALL occur in combination with line 1 of a ship-to address and an SSCC
4309	Ship-to / Deliver-to GEO location	00	Ship-to / Deliver-to GEO location SHALL occur in combination with an SSCC
431N	Return-to address GS1 Application Identifiers	00	Return-to address GS1 Application Identifiers SHALL occur in combination with an SSCC
4313	Return-to address line 2	4312 AND 00	Return-to address line 2 SHALL occur in combination with line 1 of a return-to address
432N	Service-related GS1 application identifiers for transport process	00	Service-related GS1 application identifiers SHALL occur in combination with an SSCC
4330	Maximum temperature in Fahrenheit	00	Maximum temperature in Fahrenheit SHALL occur in combination with an SSCC
4331	Maximum temperature in Celsius	00	Maximum temperature in Celsius SHALL occur in combination with an SSCC
4332	Minimum temperature in Fahrenheit	00	Minimum temperature in Fahrenheit SHALL occur in combination with an SSCC
4333	Minimum temperature in Celsius	00	Minimum temperature in Celsius SHALL occur in combination with an SSCC
7001	NATO stock number	01 XOR 02 XOR 8006 XOR 8026 ***	The NATO stock number SHALL occur in combination with: <ul style="list-style-type: none"> ■ a GTIN; or ■ a GTIN of contained trade items; or ■ an ITIP ■ an ITIP of contained trade item pieces
7002	UNECE meat carcasses and cuts classification	01 XOR 02	The UNECE meats carcasses and cuts classification SHALL occur in combination with: <ul style="list-style-type: none"> ■ a GTIN; or ■ a GTIN of contained trade items.

If element string		Then mandatory associated element string	Rule
AI	Designation	AI	
7003	Expiration date and time	01 XOR 02	The expiration date and time SHALL occur in combination with: <ul style="list-style-type: none"> a GTIN; or a GTIN of contained trade items.
7004	Active potency	01 AND 10	The active potency SHALL occur in combination with the batch/lot number and the GTIN.
7005	Catch area	01 XOR 02	The catch area SHALL occur in combination with: <ul style="list-style-type: none"> a GTIN; or a GTIN of contained trade items.
7006	First freeze date	01 XOR 02	The first freeze date SHALL occur in combination with: <ul style="list-style-type: none"> a GTIN; or a GTIN of contained trade items.
7007	Harvest date	01 XOR 02	The harvest date SHALL occur in combination with: <ul style="list-style-type: none"> a GTIN; or a GTIN of contained trade items.
7008	Species for fishery purposes	01 XOR 02	The species for fishery purposes SHALL occur in combination with: <ul style="list-style-type: none"> a GTIN; or a GTIN of contained trade items.
7009	Fishing gear type	01 XOR 02	The fishing gear type SHALL occur in combination with: <ul style="list-style-type: none"> a GTIN; or a GTIN of contained trade items.
7010	Production method	01 XOR 02	The production method SHALL occur in combination with: <ul style="list-style-type: none"> a GTIN; or a GTIN of contained trade items.
7011	Test by date	01 XOR 02	The test by date and optional time SHALL occur in combination with: <ul style="list-style-type: none"> a GTIN; or a GTIN of contained trade items.
703(s)	Number of processor	01 XOR 02	The number of processor SHALL occur in combination with: <ul style="list-style-type: none"> a GTIN; or a GTIN of contained trade items.
710, 711, 712, 713, 714, 715, 716	National Healthcare Reimbursement Number	01	National Healthcare Reimbursement Number(s) SHALL occur in combination with the GTIN.
7020	Refurbishment lot ID	(01 XOR 8006***) AND 416	The refurbishment lot ID SHALL occur in combination with the GLN of production/service location <u>and</u> : <ul style="list-style-type: none"> a GTIN; or an ITIP
7021	Functional status	01 XOR 8006***	The functional status SHALL occur in combination with: <ul style="list-style-type: none"> a GTIN; or an ITIP
7022	Revision status	(01 XOR 8006***) AND 7021	The revision status SHALL occur in combination with the functional status <u>and</u> : <ul style="list-style-type: none"> a GTIN; or an ITIP
7041	UN/CEFACT freight unit type	00	The UN/CEFACT freight unit type SHALL occur with an SSCC.
723s	Certification reference	01 XOR 8004	Certification reference SHALL occur in combination with: <ul style="list-style-type: none"> a GTIN; or a GIAI

If element string		Then mandatory associated element string	Rule
AI	Designation	AI	
7240	Protocol ID	01 XOR 8006	The protocol ID SHALL occur in combination with a GTIN
7241	AIDC media type	8017 XOR 8018	The AIDC media type SHALL occur in combination with: <ul style="list-style-type: none"> the GSRN for the provider; or the GSRN for the recipient
7242	Version Control Number (VCN)	8017 XOR 8018	The Version Control Number SHALL occur in combination with: <ul style="list-style-type: none"> the GSRN for the provider; or the GSRN for the recipient
7250, 7251, 7252, 7257, 7259	Date of birth, date and time of birth, biological sex, address of person, baby of family name	8018	Date of birth, date and time of birth, biological sex, address of person and baby of family name SHALL occur in combination with a Global Service Relation Number – Recipient
7253, 7254, 7255, 7256	Family name of person, given name of person, name suffix of person, full name of person	8017 XOR 8018	Family name of person, Given name of person, Full name of person and Name suffix of person SHALL occur in combination with: <ul style="list-style-type: none"> Global Service Relation Number – Provider; or Global Service Relation Number – Recipient
7258	Baby birth sequence indicator	8018 AND 7259	Baby birth sequence indicator SHALL occur in combination with a Global Service Relation Number – Recipient and Baby of family name.
8001	Dimensions of roll products	01	Dimensions of roll products SHALL occur in combination with the GTIN. Note: The GTIN must relate to a variable measure trade item.
8005	Price per unit of measure	01 XOR 02	The price per unit of measure SHALL occur in combination with: <ul style="list-style-type: none"> a GTIN; or a GTIN of contained trade items. Note: The GTIN must relate to a variable measure trade item.
8007	International Bank Account Number	8020 AND 415	The International Bank Account Number SHALL occur in combination with the payment slip reference number and the GLN of the invoicing party.
8008	Date and time of production	01 XOR 02	The date and time of production SHALL occur in combination with: <ul style="list-style-type: none"> a GTIN; or a GTIN of contained trade items.
8009	Optically readable sensor indicator	01 OR 00	The Optically Readable Sensor Indicator Number SHALL occur in combination with the GTIN or SSCC. Note the two data elements may or may not appear in the same data carrier.
8011	CPID serial number	8010	The CPID serial number SHALL occur in combination with the CPID.
8012	Software Version	01 XOR 8006***	The software version SHALL occur in combination with: <ul style="list-style-type: none"> a GTIN; or an ITIP
8014	Highly Individualised Device Registration Identifier (HIDRI)	01	Highly Individualised Device Registration Identifier SHALL occur in combination with: <ul style="list-style-type: none"> a GTIN with AI (01)
8019	Service Relation Instance Number	8017 XOR 8018	The Service Relation Instance Number SHALL occur in combination with: <ul style="list-style-type: none"> the GSRN for the provider; or the GSRN for the recipient.

If element string		Then mandatory associated element string	Rule
AI	Designation	AI	
8020	Payment slip reference number	415	The payment slip reference number SHALL occur in combination with the GLN of the invoicing party.
8026	ITIP of contained pieces	00 AND 37	The ITIP of contained pieces SHALL occur in combination with an SSCC and the count of the pieces.
8030	Digital Signature (DigSig)	(01 AND 21) XOR (8006 AND 21) XOR (8010 AND 8011) XOR 8003 XOR 8004 XOR 8017 XOR 8018 XOR 00 XOR 253 XOR 255	The Digital Signature (DigSig) SHALL occur in combination with one of the following: <ul style="list-style-type: none"> ■ Global Trade Item Number and Serial number ■ Identification of an individual trade item piece and Serial number ■ Component/Part Identifier and Component/Part Identifier serial number ■ Global Returnable Asset Identifier including Serial component ■ Global Individual Asset Identifier ■ Global Service Relation Number - Provider ■ Global Service Relation Number - Recipient ■ Serial Shipping Container Code ■ Global Document Type Identifier including Serial component ■ Global Coupon Number including Serial component
8111	Loyalty points of a coupons	255	Loyalty points of a coupon SHALL occur in combination with the GCN.
8200	Extended packaging URL	01	The extended packaging URL SHALL occur in combination with the GTIN.
*	The AIs for trade measures are set out in section 3.6.2 Trade measures: AIs (31nn, 32nn, 35nn, 36nn) . <i>Note: All AIs in section 3.6.2 can be used with this AI 395n.</i>		
**	The AIs for logistics measures are set out in section 3.6.3 Logistic measures: AIs (33nn, 34nn, 35nn, 36nn)		
***	If used in combination with the identification of trade item pieces (ITIP), the optional AIs on all individual pieces of the trade item SHALL be identical.		
N	Any digit from 0 to 9		

 **Note:** Exception for point-of-sale. See figure [2.7-1. Areas of GS1 system application](#).

4.14 Human readable interpretation (HRI) rules

Human readable interpretation (HRI) rules are provided to standardise printing requirements and facilitate training of staff on how to deal with GS1 AIDC data carriers that fail to scan or read. There are two categories of rules:

- General rules that apply independent of sector, intended application or product category.
- Sector or application specific rules which must be aligned with the general rules and can be found in sections:
 - [4.14.1](#) Healthcare human readable interpretation
 - [4.14.2](#) General retail consumer trade item human readable text rules
 - [4.14.3](#) Manual date marking

There are two types of text that appear on an object: human readable interpretation (HRI) and non-HRI text.

- Human readable interpretation (HRI) represents the same data encoded in the barcode or RFID tag (see section [9](#) for full definition).
- Non-HRI text is all other text on the object which may or may not be encoded in the barcode or RFID tag (see section [9](#) for full definition).

Figure 4.14-1. Example of human readable text

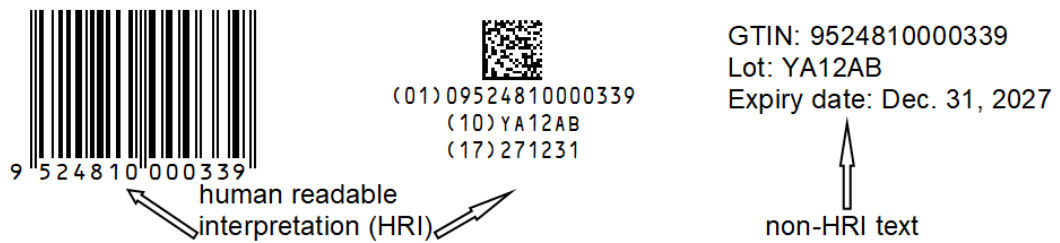

- ✔ **Note:** The following rules are intended for global use. Exceptions may occur only when local regulatory or legal requirements mandate otherwise.
- ✔ **Note:** At present, HRI rules are applicable to barcodes as rules for EPC/RFID tags are under development.
- ✔ **Note:** HRI rules for the EAN/UPC symbology and the add-on symbols are explained in section [5.2.5 Human readable interpretation](#).

General human readable text rules

1. HRI Placement

- a. Whether a barcode encodes a GS1 identification key, GS1 key attributes, or a combination of both, the HRI SHOULD be included and placed adjacent to the barcode. HRI SHOULD be grouped together wherever physically possible while maintaining the HRI legibility, minimum barcode height and/or Quiet Zones as specified in the appropriate symbol specification table in section [5.12.3](#).
- b. In cases where the HRI must be printed above, to the left, or to the right of the barcode due to packaging or space constraints, HRI SHOULD be printed adjacent so that is obviously associated with the barcode. This rule applies to all barcodes independent of printing orientation (e.g., ladder orientation).

Figure 4.14-2. Locations of HRI for barcode in ladder orientation



- c. When HRI is grouped together, it SHOULD be placed adjacent to the barcode and it SHALL always follow the sequence of the encoded data in the barcode.
- d. If the HRI for GS1 identification keys and GS1 key attributes is split, the GS1 identification key HRI SHOULD be placed adjacent to the barcode. For example, the GS1 identification key HRI is below the barcode and the GS1 key attributes HRI is above the barcode.

Figure 4.14-3. Example of split HRI placement

(10)YA12AB
 (17)271231

 (01)09524810000339

- e. An element string (application identifier and associated data) SHALL NOT be broken into multiple lines of HRI, for example the data for a serial number would appear on one line of HRI, e.g., (21) ABCDEF12345.
- f. When using non-HRI text, the element strings SHOULD NOT be broken into multiple lines.
- g. HRI SHALL appear except in rare circumstances for specific applications where there are extreme space constraints (e.g., direct part marking, loose fresh produce). If the barcode cannot be read or scanned and the HRI does not appear on the object, non-HRI text SHOULD be used as backup information.

2. Font and legibility

- a. A clearly legible font SHALL be used e.g., OCR-B as defined in *ISO/IEC 30116*. Reasonable alternative fonts and character sizes are acceptable provided the interpretation is clearly legible. When applying the “clearly legible” principle, the following principles and examples separate a best practice versus below average implementation.
 - i. Monospaced font types such as OCR-B or Sans serif font types such as Arial are preferred.
 - ii. Bold, italics, light or narrow versions of a font SHOULD NOT be used.
 - iii. The font size SHOULD be at least 2 mm (0.08 in) in height
 - iv. Spaces SHALL NOT be encoded in the barcode.
 - v. Spaces may be used in the HRI itself to ease manual data input.
 - vi. The spaces between characters driven by the font type SHOULD NOT be reduced.
- b. HRI SHALL be limited to element strings and will not include barcode overhead such as separator characters.
- c. When using GS1 element string syntax, although parentheses are not encoded in the barcode, parentheses SHALL surround AIs in HRI.

3. URL

- a. When the GS1 Digital Link URI syntax for trade item extended packaging applications is encoded in a barcode, it is left to the brand owner’s discretion to use the GS1 Digital Link URI in non-HRI text (e.g., GTIN only 09520123456788 or URL <https://brand.example.com/01/09520123456788>).
- b. When AI (8200) appears on the object, the expression of the URL SHALL NOT appear in HRI. If it appears in non-HRI text, it SHALL be expressed as <http://brandownerassignedURL.com/GTIN> (where GTIN expressed as 14 digits).

4. Data titles

As a non-HRI text option, the data title (see section 3.2) may be associated with the data instead of using the AI numbers. See figure 4.14-1 which shows expiration date and lot number identified with non-HRI text and where, in the same figure, the same data is shown using the all-AI format.

5. GS1 Logistics Label

- a. HRI alongside a 2D barcode on a logistic label is not required if this is already present with the GS1-128 symbol, or is present as data titles and data content elsewhere on the label.

- b. When a logistic label displays a 2D barcode encoding transport process information that is otherwise represented in text or graphic on the label, HRI of this information is not required.
- c. On GS1 Logistics Labels HRI characters SHALL be no less than 3 mm (0.1181 in) high.

4.14.1 Healthcare human readable interpretation rules

The GS1 system requires printing both the GS1 AIDC data carrier and the HRI that represents all the information encoded within that GS1 AIDC data carrier.

If the GS1 AIDC data carrier cannot be read or scanned, the HRI should be used as back up information. The GS1 preferred format for HRI when applied on healthcare trade items SHALL be as noted in the general HRI rules found in section [4.14](#).

When considering the practical implementation and application of HRI during the creation of the product packaging, many factors must be taken into account to determine if and how HRI is included with the symbol. These factors may include the type of product being labelled or marked, product use, available space for marking, alternate data availability, regulatory or legal requirements, technical constraints, etc.

However, printing both the GS1 AIDC data carrier and the associated HRI may not be possible due to many factors such as the intended use of the item, available space for marking, etc. Deviation from the HRI format should be minimised and consider impacts to downstream trading partners and users.

Typical examples are shown the figure below.

Figure 4.14.1-1. Preferred HRI format GS1 DataMatrix example



Figure 4.14.1-2. Preferred HRI format GS1-128 example



If a deviation from the preferred format is required that results in HRI not being printed, then a combination of HRI and non-HRI text may be used. When doing so, the following rules apply:

- If the data represented in the non-HRI text is exactly as in the HRI, then the appropriate AI SHALL be printed along with the data title. See figure [4.14.1-3](#).
- If data represented in the non-HRI text does not match the HRI, then only a data title may be used. The AI SHALL NOT be printed. This is illustrated in figure [4.14.1-4](#) by the GTIN and Expiry.
- The selection of data titles may be determined by the manufacturer based on regulatory, local language requirements, relevant standards (e.g., *ISO/IEC 15223*) or appropriate abbreviations.

Figure 4.14.1-3. Combination of HRI with AIs, non-HRI text and data titles example

GTIN (01) 09524000059109
 SERIAL (21) 12345678p901
 LOT (10) 1234567p
 EXPIRY (17) 271120





Figure 4.14.1-4. Combination of HRI with AIs, non-HRI text (GTIN and Expiry) and data titles example

GTIN 09524000059109
 SERIAL (21) 12345678p901
 LOT (10) 1234567p
 EXPIRY 20 Nov 2027



If it is not possible to print both the GS1 AIDC data carrier and the HRI, figure 4.14.1-5 SHOULD be used to determine how HRI will be implemented. When it is not possible to print all of the HRI, preference for printing SHALL be given to the GS1 key.

Figure 4.14.1-5. Healthcare human readable interpretation (HRI) decision tree (to be used only when limited space is available)

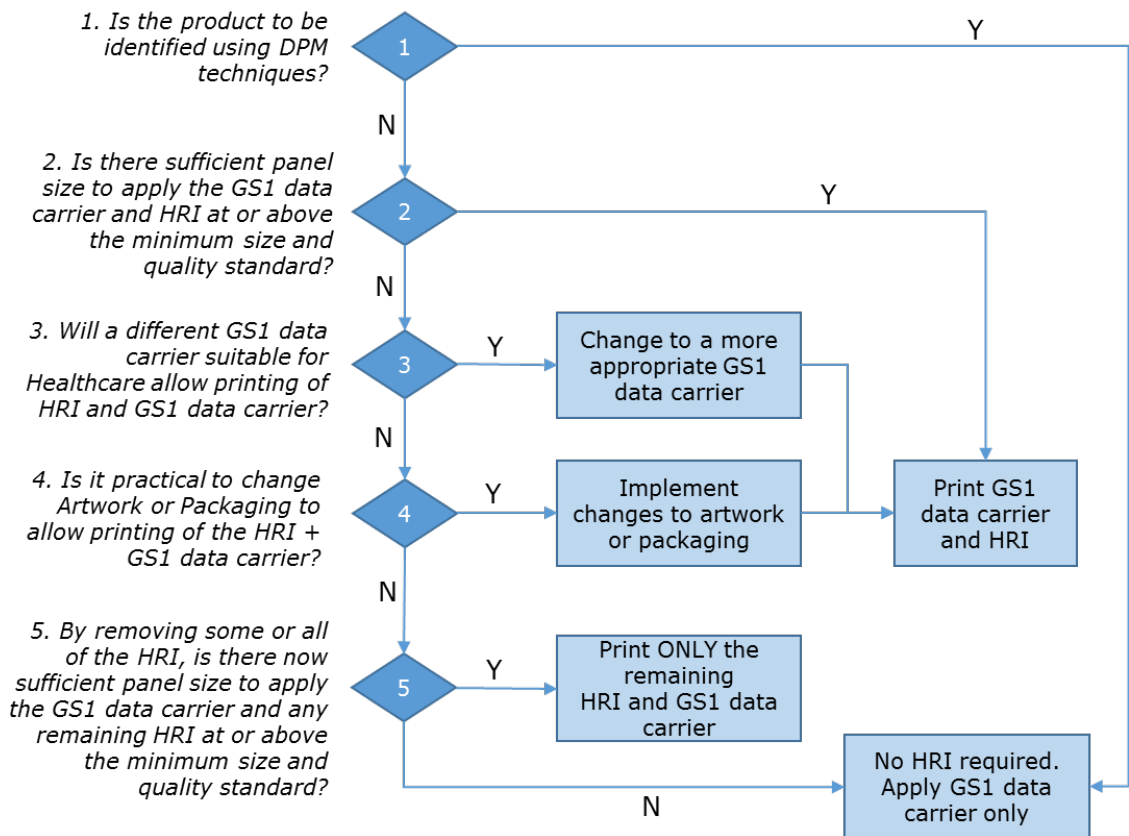

Note: Figure 4.14.1-5 is intended for use when there is no regulatory mandate that conflicts with this guidance and where space constraints limit the ability to provide both the GS1 AIDC marking and the associated HRI text—this document does not impact the non-HRI text that is required for compliance with labelling regulations. In all situations, applicable regulatory requirements SHALL take precedence. Brand owners are responsible to understand and comply with applicable regulations and to document deviations from those regulations and

their justifications for such deviations in the product master record files or other formal document control files.

- ✔ **Note:** Active potency, AI (7004) HRI rule. Printing of the active potency on the item is controlled by regulation. Human readable interpretation of the active potency is not required on the trade item.

4.14.2 General retail consumer trade item human readable text rules

General retail consumer trade items have specific rules that build on the general human readable interpretation (HRI) rules in section 4.14.

- ✔ **Note:** The following rules are intended for global use. Exceptions may occur only when mandated by regulatory or legal requirements. For example, refer to the sections related to healthcare section 4.14 for regulated healthcare trade items sold in retail.

The barcodes for point-of-sale (POS) SHALL have GTIN in HRI adjacent to the barcode. HRI for any additional consumer engagement (extended packaging) barcode encoding GS1 Digital Link URI SHALL be left to the discretion of the brand owner. See figure 4.14-4

Figure 4.14-4. Example of extended packaging and POS barcodes



Consumer engagement barcode

Adjacent POS barcodes

(See 6.3.3.1 preferred placement)

For EAN/UPC barcodes the HRI SHALL show the GTIN-8, GTIN-12, or GTIN-13 and SHALL be placed below the barcode.

Figure 4.14-5. Example of EAN-13 with EAN/UPC HRI format



GS1 DataBar Retail POS family, GS1 DataMatrix, Data Matrix (GS1 Digital Link URI) and QR Code (GS1 Digital Link URI) SHALL display (01) followed by the encoded GTIN in a 14-digit format.

Figure 4.14-6. Example of GTIN-13 in 14-digit format

 GS1 DataMatrix
 (GS1 element string syntax)

(01)09524810000339

 QR Code
 (GS1 Digital Link URI syntax)

(01)09524810000339



Note: The example.com domain name (reserved in [RFC 2606](#)) is used in the example as a place holder for any domain name.

The 14-digit GTIN HRI is not required for any 2D barcode displayed on the packaging when it is adjacent to a linear barcode with HRI or if the 2D barcode is intended for consumer engagement. When a 2D barcode will be the only barcode for the GTIN, it SHALL display the 14-digit GTIN HRI as shown in figure 4.14-6.

When a linear EAN-8, EAN-13 or UPC-A barcode and 2D barcode are adjacent on a general retail consumer trade item, HRI for the GTIN is only required for the linear barcode. If the linear EAN-8, EAN-13, UPC-A or UPC-E barcode and 2D barcode are unable to be adjacent, then the GTIN SHOULD accompany both.

Figure 4.14-7. Example of adjacent barcode HRI

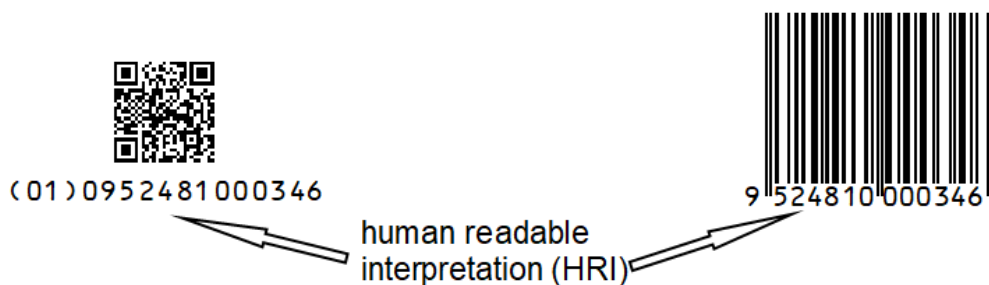
Figure 4.14-8. Example of non-adjacent barcode HRI

When a UPC-E barcode and 2D barcode are adjacent on a general retail consumer trade item, HRI for the GTIN is required and SHOULD accompany both. UPC-E encodes a GTIN-12 using a zero-suppression process described in section [5.2.2.4](#).

Figure 4.14-9. Example of adjacent UPC-E barcode HRI

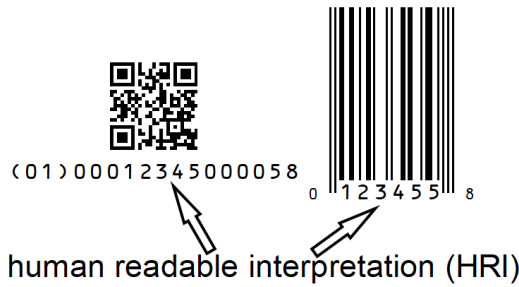

HRI beyond GTIN is not required when using barcodes encoded with GS1 element string or GS1 Digital Link URI syntax on general retail consumer trade items. If additional GS1 element strings are used by downstream trading partners (e.g., retailer and/or consumers), they SHOULD appear on the object in human readable text.

Figure 4.14-10. Example of human readable placement

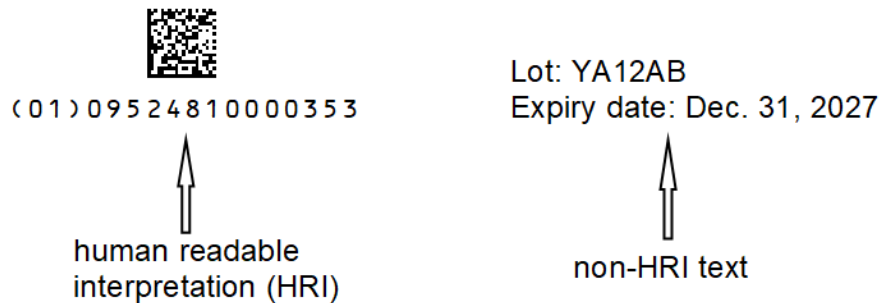

GS1 element strings encoded in a data carrier which are intended for internal use, e.g., AI (243), may appear on the object in either non-HRI text or HRI. Non-HRI SHOULD NOT be placed adjacent to the barcode as this can make it difficult for the GTIN to be identified.

Figure 4.14-11. Example of internal use application identifier human readable placement

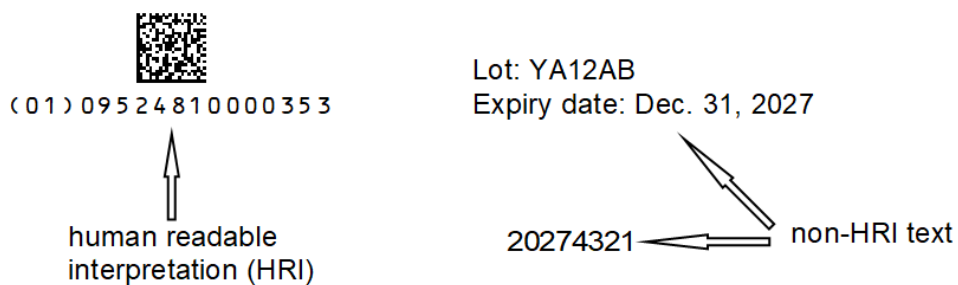

4.14.3 Manual date marking

Where regulations and/or trade partner agreements require applied date markings for stock rotation and manual identification, the ISO standard (8601) for date sequence SHOULD be used. The format SHOULD be YYYY-MM-DD preceded by the date type short form (See figure below for respective date types) based on ISO standard abbreviations (15223).

Figure 4.14.3-1. Short forms by date type

Date type	Short form
Production	PROD
Packaging	PACK
Best Before	BEST
Expiration	EXP

AIDC techniques are suggested over any manual process to ensure accurate and timely stock rotation. Every effort should be made to adopt an automated process to increase productivity and date management.

4.15 Multiple barcode management practices for trade items (cross-sector)

When additional barcodes are introduced into an existing scanning environment or business application, all application standard conformant barcodes SHALL remain as choices. This section provides a set of management practices intended to permit the use of multiple barcodes on the same trade item.

4.15.1 Multiple barcode management practices for trade items (all sectors)

1. **Current standards:** All scanning systems SHALL deploy symbology identifiers (see section [5.1.3](#)) and when using GS1 Application Identifiers, process them according to GS1 rules (see section [7.8](#)).
2. **Use of GTIN:** All GS1 data carriers on a single trade item SHALL encode the same GTIN.
3. **Use of GTIN attributes:** When the GTIN and GTIN attributes occur in multiple data carriers on a single trade item, the attribute values SHALL be the same.
4. **GTIN plus attribute(s) flag:** When applications require GTIN plus additional data to be captured in a multiple barcode environment, modifications to systems SHOULD be made to automate this requirement.
5. **Adjacent placement:** When two barcodes can be used for the same application (i.e., point-of-sale, point of care, general distribution) they SHOULD be placed adjacent to each other while maintaining their Quiet Zones. The orientation (stack or row of barcodes) or sequence (which barcode is placed on the left, right, top, or bottom) SHALL be determined by the brand owner.
 - a. When adjacent placement on one surface of an object is not possible, the barcodes SHOULD be placed on an adjoining surface of the object. This practice does not supersede any section [6](#) barcode placement rule (e.g., 8 mm (0.3 inch) free space between barcodes and panel edge).
6. **Non-adjacent placement:** When two barcodes are used for different applications (e.g., point-of-sale, extended packaging), they SHOULD be placed non-adjacent to one another.
7. **Obscure placement:** When a barcode is used for production control purposes only (e.g., Data Matrix encoded with a non-GS1 syntax to match label to product), it SHOULD be made as obscure as possible or even obstructed on the trade item package.
8. **Use of GS1-128 or 2D barcode as supplemental barcode with EAN/UPC or ITF-14 as the main barcode:** In general retail and general distribution, where EAN/UPC or ITF-14 is used to encode the GTIN and where a GS1-128 or 2D barcode is used to encode GTIN attributes, the same GTIN SHALL be encoded in all GS1 barcodes.
9. **GS1-128 as supplemental barcode:** When an EAN/UPC or ITF-14 is used to encode GTIN and where GS1-128 is used to encode GTIN attributes, GS1-128 SHOULD encode GTIN and the GTIN attributes in a single barcode to ensure accurate data association.
10. **Use of 2D barcode as supplemental barcode with GS1-128 as main barcode:** In general distribution, where GS1-128 is used to encode GTIN and attributes, these element strings at a minimum SHALL be encoded in the supplemental 2D barcode.

4.15.2 GS1 multiple barcode management practice for general retail

In addition to the requirements outlined in section [4.15.1](#), the following rules apply to the use of multiple barcodes for general retail.

1. **Migration to 2D barcodes:** A GS1 DataMatrix, QR Code (GS1 Digital Link URI) or Data Matrix (GS1 Digital Link URI), SHALL be used in addition to the EAN/UPC, or a GS1 DataBar retail POS family of barcodes, to ensure stakeholders that are not yet able to consistently scan 2D barcodes are not negatively impacted. Application Standard Profiles in section 8 provide

information on conformance requirements for the transition period and future use of 2D barcodes at retail POS.

When there is more than one barcode with GTIN on trade items, it is essential that the POS systems will ensure:

- The system SHALL only process one set of the desired data in the final transaction.
- Scanning systems SHOULD only produce one acknowledgement (e.g., beep) when multiple barcodes are scanned from the same trade item.

! **Important:** If the points above are not implemented, unintended POS transactions may occur.

2. Placement when using a 2D barcode for multiple applications: When a 2D barcode will be scanned in multiple applications (e.g., point-of-sale, inventory management and consumer engagement), placement for POS takes precedence. The same adjacent placement rules as stated in section [4.15.1](#) are applicable.

✓ **Note:** Where GS1 DataBar and 2D barcodes are used, GTIN and GTIN attributes SHALL be encoded in a single barcode to ensure accurate data association.

4.15.3 GS1 multiple barcode management practices for healthcare

In addition to the requirements outlined in section [4.15.1](#), the following rules apply to the use of multiple barcodes for healthcare.

- 1. GTIN in GS1 DataMatrix and GS1 DataBar processing (retail healthcare):** In order to facilitate migration away from a multiple barcode environment where one retail pharmacy requires EAN/UPC and another retail pharmacy requires GS1 DataMatrix or GS1 DataBar Expanded, at a minimum, retail pharmacies SHALL have the capability to process the AI (01) GTIN from GS1 DataMatrix and GS1 DataBar in addition to the capability for EAN/UPC.
- 2. GTIN in GS1 DataMatrix, GS1 DataBar and GS1-128 processing (non-retail healthcare):** In order to facilitate migration away from a multiple barcode environment where one healthcare provider requires EAN/UPC or ITF-14 and another healthcare provider requires GS1 DataMatrix, GS1 DataBar Expanded, or GS1-128, at a minimum, non-retail pharmacies SHALL have the capability to process AI (01) GTIN from GS1 DataMatrix, GS1 DataBar and GS1-128 in addition to the capability for EAN/UPC and ITF-14.
- 3. GS1-128 as secondary symbol:** In point-of-care applications, where EAN/UPC or ITF-14 is used to encode GTIN and where GS1-128 is used to encode GTIN attributes, GS1-128 SHOULD encode GTIN as it is best practice to encode the GTIN attributes and the GTIN in a single symbol whenever possible to ensure accurate data association.

✓ **Note:** Where GS1 DataBar and GS1 DataMatrix are used, GTIN and GTIN attributes SHALL be concatenated to ensure accurate data association.

4. Scenario-based management practices: Multiple barcode practices which apply to all sectors are found in section [4.15.1](#) and take precedence over those specific only to healthcare. While industry best practice focuses on using only one barcode per package, a product package that serves multiple markets may have the need for application of multiple barcodes. When this occurrence is unavoidable, the management practices for use of multiple symbols found in figure [4.15.3-1](#) apply for regulated healthcare trade items. The figure separates solutions based on combinations of scanner environments encountered for each scenario:

- Scanners encountered combination #1: Package scanned in retail pharmacies (Yes or No).
- Scanners encountered combination #2: Package scanned in general distribution (Yes or No).

Figure 4.15.3-1. Multiple barcode management practices

Combinations of scanners encountered	Barcode data scenario		Scanner environment		Symbol arrangement	Barcode options		Gen Specs	Proposal
	Symbol 1	Symbol 2	Retail pharmacy or non-retail pharmacy/bedside	Auto-mated conveyor	Vertical or horizontal			Section	
#1	GTIN A	Only attributes for GTIN A	Y	N	NA	GS1 DataMatrix GS1-128 GS1 DataBar * EAN/UPC plus GS1 DataMatrix, GS1 DataBar Expanded, GS1-128, or * EAN/UPC, GS1 DataBar, or GS1-128 plus ** Composite Component		2.1.4 2.1.5 4.15.1	See Note 1 See Note 10 For * see Note 2 For ** see Note 3
#2	GTIN A	Only attributes for GTIN A	Y	Y	Horizontal	GS1 DataMatrix GS1-128 *EAN/UPC plus GS1 DataMatrix or GS1-128		2.1.7 4.15.1	See Note 1 See Note 10 For * see Note 2
#1	GTIN A	GTIN A + GTIN A attributes	Y	N	Depends upon packaging limitations	GS1 DataMatrix GS1-128 GS1 DataBar * EAN/UPC plus GS1 DataMatrix, GS1 DataBar Expanded, GS1-128, or GS1 DataBar, or GS1-128 plus ** Composite Component or * EAN/UPC with ** Composite Component		2.1.4 2.1.5 4.15.1	See Note 1 See Note 4 See Note 10 For * see Note 6 For ** see Note 3
#2	GTIN A	GTIN A + GTIN A attributes	Y	Y	Depends upon packaging limitations	GS1 DataMatrix GS1-128 *EAN/UPC plus GS1 DataMatrix or GS1-128		2.1.7 4.15.1	See Note 1 See Note 2 See Note 4 For * see Note 6 See Note 10
#1	GTIN A + Attribute Set 1	GTIN A + Attribute Set 1	Y	N	Duplicate symbols on bulky packages	GS1 DataMatrix GS1-128 GS1 DataBar Expanded EAN/UPC plus Composite Component	Duplicate of first symbol	2.1.4 2.1.5	See Note 1 See Note 5 See Note 7 See Note 10
#2	GTIN A + Attribute Set 1	GTIN A + Attribute Set 1	Y	Y	Duplicate symbols on bulky packages	GS1 DataMatrix GS1-128 EAN/UPC plus Composite Component	Duplicate of first symbol	2.1.7	See Note 1 See Note 5 See Note 7 See Note 10

Combinations of scanners encountered	Barcode data scenario		Scanner environment		Symbol arrangement	Barcode options		Gen Specs	Proposal
	Symbol 1	Symbol 2	Retail pharmacy or non-retail pharmacy/ bedside	Auto-mated conveyor	Vertical or horizontal			Section	
#1	GTIN A + Attribute Set 1	GTIN A + Attribute Set 2	Y	N	Depends upon packaging limitations	GS1 DataMatrix GS1-128 GS1 DataBar Expanded EAN/UPC plus Composite Component	GS1 DataMatrix GS1-128 GS1 DataBar Expanded EAN/UPC plus Composite Component	2.1.4 2.1.5	See Note 1 See Note 5 See Note 8 See Note 10
#2	GTIN A + Attribute Set 1	GTIN A + Attribute Set 2	Y	Y	Horizontal	GS1 DataMatrix GS1-128	GS1 DataMatrix GS1-128	2.1.7	See Note 1 See Note 5 See Note 8 See Note 10
#1	GTIN with serial number	GIAI or GRAI	Not permitted in regulated healthcare on small surgical instruments where only one mark can be made based on the available marking surface and SGTIN is source-marked by brand owner on that surface See Note 10						
#1 or #2	GTIN A	GTIN B	Not permitted						
#2	GTIN A	SSCC	Permitted on trade items which also serve as logistics units. Symbol placement per section 6 (All clauses contained in sections 6.2 , 6.4 , 6.6 , 6.7 and 6.8). See Note 10						
#1	SSCC	AI (02) + AI (37)	Y	N	Vertical	GS1-128	GS1-128	2.2.1	See Note 9
#2	SSCC	AI (02) + AI (37)	Y	Y	Vertical	GS1-128	GS1-128	2.2.1	See Note 9
#1 and #2	GS1 data carried by 1 or 2 symbols	Non-GS1 data	Symbols encoding internal or proprietary data SHOULD NOT be placed in a location where they could be scanned in the open supply chain (e.g., retail POS, by an automated conveyor line scanner per GS1 specifications) See section 4.15.1 – Obscure placement and Note 10 below						

Combinations of scanners encountered	Barcode data scenario		Scanner environment		Symbol arrangement	Barcode options	Gen Specs	Proposal
	Symbol 1	Symbol 2	Retail pharmacy or non-retail pharmacy/bedside	Auto-mated conveyor	Vertical or horizontal		Section	

Notes:

- Note 1: Concatenation of GTIN and GTIN attributes into one symbol is the preferred option for Regulated healthcare retail consumer trade items to validate connectivity between GTIN and attributes. Separating GTIN attributes from the GTIN in the barcode SHOULD be avoided wherever possible as improper association is possible. The scenario takes into account the use of EAN/UPC which is widely used in retail pharmacies to capture GTIN but once a market is prepared to support a data carrier which can encode GTIN plus the GTIN attributes, this data carrier SHOULD replace EAN/UPC when GTIN attributes are required.
- Note 2: Symbols which are not preferred for regulated healthcare retail consumer trade items because they do not allow for concatenation but remain permissible options.
- Note 3: GS1 Composite Component does not stand alone as a complete symbol; it is necessary to associate the composite component with a linear symbol such as EAN/UPC, ITF-14, GS1-128 or GS1 DataBar. GS1 Composite Component therefore remains a legitimate option but only in non-retail applications, GS1 DataMatrix is preferred for regulated healthcare retail consumer trade items based on its ability to encode all information in one symbol and do so efficiently in terms of print speed and panel size.
- Note 4: It is recommended to use only one symbol that encodes the GTIN and attributes.
- Note 5: When two symbols are required to encode a large number of GTIN attributes, both symbols SHOULD be the same symbology and both encode GTIN.
- Note 6: Symbols which are not preferred for regulated healthcare retail consumer trade items because they do not allow for concatenation but remain permissible options.
- Note 7: Recommended for bulky or large trade items or pallets.
- Note 8: Wherever possible use of one symbol to encode GTIN plus all attributes is preferred to encoding attributes in two symbols.
- Note 9: AI (02) + AI (37) not recommended in regulated healthcare supply chain.
- Note 10: Since June 2007 GS1 has recommended all trading partners in the healthcare sector invest exclusively in imaging-based scanners. Now that GS1 DataMatrix has been approved within the standard, it is important to inform all trading partners of a process within GS1 to establish target deployment dates. Without these dates, brand owners do not have a way to know when to deploy GS1 DataMatrix on their packaging and those needing to invest in scanning equipment may inadvertently purchase equipment that will not support the standards. To see GS1 healthcare's position paper on GS1 DataMatrix adoption, visit <https://www.gs1.org/healthcare>.

4.16 Deprecated rules

This section contains rules that have been deprecated. The rules are included as reference for pre-existing situations where the rules may still apply.

4.16.1 Deprecated GTIN reuse rules

These rules are deprecated as of 1 January 2019.

A GTIN allocated to a trade item that has become obsolete must not be reused for another trade item until at least 48 months have elapsed after:

- the expiration date of the last original trade items produced with that number.
- or-
- the last original trade items produced with that number have been supplied to the customer.

The following sector-specific rules apply:

- Apparel: In the case of clothing the minimum retention period is reduced to 30 months.
- Healthcare: Companies must ensure that GTINs allocated to regulated healthcare trade items SHALL NOT be reused.

Exception: regulated healthcare trade items that have been withdrawn from the market and are reintroduced may use the original GTIN if they are reintroduced without any modifications or changes which require a new GTIN as specified by the [GTIN Management Standard](#).

- Technical industries: GTINs that are marked directly on components and parts, such as used in rail rolling stock and infrastructure, SHALL NOT be reused (also see [2.6.14](#)).

For other trade items, brand owners should consider a longer period depending upon the type of goods and/or any regulatory framework. For example, steel beams may be stored for many years before entering the supply chain, and processes should be put in place to ensure that the GTIN is not reallocated for a significant period of time.

In addition, when contemplating the reuse of a GTIN, consideration should be given to the use of data associated with the original GTIN by trading partners for statistical analysis or service records, which may continue long after the original trade item was last supplied.

If a GTIN has been assigned to an item, which was then never actually produced, the GTIN may be deleted from any catalogue immediately without first being marked as discontinued. In this exceptional case the GTIN may be reused 12 months after deletion from the seller's catalogue.

4.16.2 Deprecated GLN reuse rules

These rules are deprecated as of 1 July 2022.

A Global Location Number (GLN) that has been previously used and has become obsolete must not be reused for another location until at least 48 months have elapsed. A longer period may be needed in accordance with government requirements, such as invoicing and taxation or requirements related to the nature of the location (e.g., a bonded warehouse). This period provides time for all references of the old GLN to be removed from trading partner files.

All issuers of Global Location Numbers (GLNs) must ensure that GLNs allocated for locations used in the healthcare supply chain SHALL NOT be reused, e.g., locations where treatment of patients takes place, etc.

5 Data carriers

5.1 Introduction

A data carrier is a means of representing data in machine readable form. Barcode symbologies that are endorsed by GS1 are described in sections 5.2 to 5.11; barcode production and quality assessment are covered in section 5.12. EPC/RFID is described in section 5.13.

The GS1 system specifies the data carrier used to represent any given element string. Section 2 covers rules indicating which data carrier should be used to represent which element strings in particular applications.

5.1.1 Overview of GS1 barcodes

The GS1 system uses the following data carriers:

- The EAN/UPC symbology family of barcodes (UPC-A, UPC-E, EAN-13 and EAN-8 barcodes and the two- and five-digit add-on symbols) can be read omnidirectionally. These symbols must be used for all items that are scanned at the point-of-sale and may be used on other trade items.

Figure 5.1.1-1. UPC-A and EAN-13 barcodes

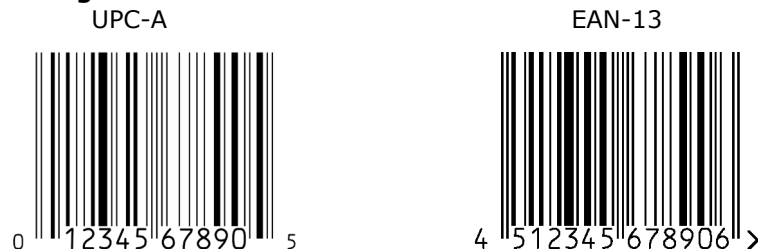

- ITF-14 (Interleaved 2-of-5) barcodes carry ID numbers only on trade items that are not expected to pass through the point-of-sale. ITF-14 symbols are better suited for direct printing onto corrugated fibreboard.

Figure 5.1.1-2. ITF-14 barcode

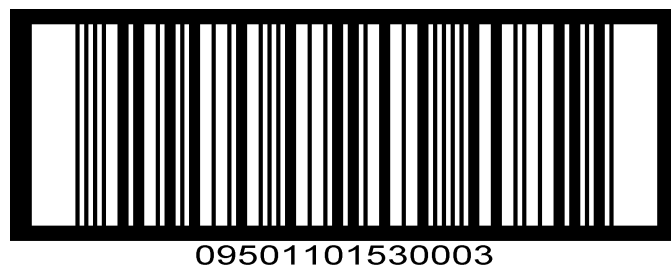

- The GS1-128 barcode is a subset of the Code 128 barcode symbology. Its use is exclusively licenced to GS1. This extremely flexible symbology encodes element strings using GS1 Application Identifiers.

Figure 5.1.1-3. GS1-128 barcode

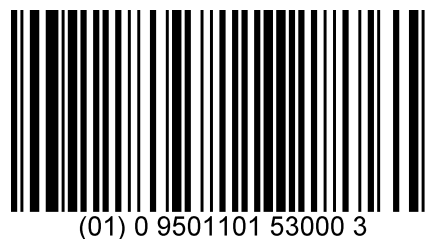

- GS1 DataBar is a family of linear symbologies used within the GS1 system. This family of linear symbologies in most cases implicitly encodes GS1 Application Identifier (01) and in the case of GS1 DataBar Expanded explicitly encodes element strings using GS1 Application Identifiers.

Figure 5.1.1-4. GS1 DataBar Omnidirectional barcode

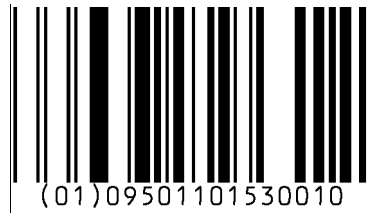

- Composite Component symbols do not exist in isolation. The primary identification number is always encoded in the linear symbol and supplementary GS1 Application Identifier element strings are encoded in the two-dimensional (2D) component where they take up less space.

Figure 5.1.1-5. GS1 DataBar Stacked Omnidirectional barcode with a Composite Component



- GS1 DataMatrix implementing ECC 200 error correction is a subset of *ISO/IEC 16022* and is the only version that supports GS1 system data structures encoded with GS1 element string syntax, including Function 1 Symbol Character (FNC1). GS1 DataMatrix SHALL be implemented per approved GS1 system application standards, such as those for regulated healthcare retail consumer trade items.

Figure 5.1.1-6. GS1 DataMatrix barcode



- GS1 QR Code, is a subset of *ISO/IEC 18004*. QR Code supports GS1 system data structures encoding with GS1 element string syntax, including Function 1 Symbol Character (FNC1). GS1 QR Code SHALL be implemented per approved GS1 system application standards.

Figure 5.1.1-7. GS1 QR Code barcode



- GS1 DotCode, supporting GS1 system data structures is supported by the AIM DotCode Specification, Rev 3.0, August 2014. Per the specification, "Message segments that begin with a pair of digits, without an FNC1 either before or immediately following those two digits are regarded as conveying GS1 formatted data by excluding Function 1 Symbol Character." GS1 DotCode SHALL be implemented per approved GS1 system application standards.

Figure 5.1.1-8. GS1 DotCode barcode

Data Matrix implementing ECC 200 error correction is an International Standard *ISO/IEC 16022*. Data Matrix Code supports GS1 system data structures encoded with GS1 Digital Link URI syntax. Data Matrix SHALL be implemented per approved GS1 system application standards.

Figure 5.1.1-9. Data Matrix barcode

<https://example.com/01/09506000134369>

QR Code is an International Standard *ISO/IEC 18004*. QR Code supports GS1 system data structures encoded with GS1 Digital Link URI syntax. QR Code SHALL be implemented per approved GS1 system application standards.

Figure 5.1.1-10. QR Code barcode

<https://example.com/01/09506000134369>

5.1.2 International data carrier standards

A number of national and regional standardisation bodies have developed barcode technical standards. The International Organisation for Standardisation (ISO) has published standard barcode symbology specifications via a subcommittee of ISO/IEC JTC1 (International Organisation for Standardisation/International Electrotechnical Commission Joint Technical Committee 1).

GS1 is actively involved in developing these standards. The objective is for GS1 system standards to remain fully compatible with relevant published national, regional and international symbology standards. The pertinent documents for section 5 include the latest published version of:

- **Section 5.1:** *ISO/IEC 15424: Information technology; automatic identification and data capture techniques; data carrier/symbology identifiers.*
- **Section 5.2:** *ISO/IEC 15420: Information technology; automatic identification and data capture techniques; bar code symbology specifications; EAN/UPC.*
- **Section 5.3:** *ISO/IEC 16390: Information technology; automatic identification and data capture techniques; bar code symbology specifications; ITF-14.*
- **Section 5.4:** *ISO/IEC 15417: Information technology; automatic identification and data capture techniques; bar code symbology specifications; GS1-128 Symbology specifications.*
- **Section 5.5:** *ISO/IEC 24724: Information technology; automatic identification and data capture techniques; GS1 DataBar bar code symbology specification.*
- **Section 5.6:** *ISO/IEC 16022: Information technology; automatic identification and data capture techniques; Data Matrix bar code symbology specification, as it pertains to GS1 DataMatrix.*
- **Section 5.7:** *ISO/IEC 18004:2015: Information technology; automatic identification and data capture techniques; QR Code bar code symbology specification, as it pertains to GS1 QR Code.*
- **Section 5.8:** *AIM Rev 3.0, August 2014: Information technology; automatic identification and data capture techniques; bar code symbology specification - DotCode.*
- **Section 5.9:** *ISO/IEC 16022: Information technology; automatic identification and data capture techniques; Data Matrix bar code symbology specification.*
- **Section 5.10:** *ISO/IEC 18004: Information technology; automatic identification and data capture techniques; QR Code bar code symbology specification*
- **Section 5.11:** *ISO/IEC 24723: Information technology; automatic identification and data capture techniques; EAN.UCC Composite bar code symbology specification.*
- **Section 5.12:** Barcode production and quality assessment:
 - *ISO/IEC 15415: Information technology; automatic identification and data capture techniques; bar code print quality test specification; two-dimensional symbols.*
 - *ISO/IEC 15416: Information technology; automatic identification and data capture techniques; bar code print quality test specification; linear symbols.*
 - *ISO/IEC 15419: Information technology; automatic identification and data capture techniques; bar code digital imaging and printing performance testing.*
 - *ISO/IEC 15421: Information technology; automatic identification and data capture techniques; bar code master test specifications.*
 - *ISO/IEC 15426-1: Information technology; automatic identification and data capture techniques; bar code verifier conformance specification - Part 1: Linear symbols.*
 - *ISO/IEC 15426-2: Information technology; automatic identification and data capture techniques; bar code verifier conformance specification - Part 2: Two-dimensional symbols.*
 - *ISO 1073-2: Alphanumeric character sets for optical recognition – Part 2: Character set OCR-B Shapes and dimensions of the printed image.*
 - *ISO/IEC TR 29158: Information technology; Automatic identification and data capture techniques; direct part marking (DPM) Quality Guideline.*
- **Section 5.13:** UHF and HF EPC/RFID:

- *ISO/IEC 18000-63 Information technology — Radio frequency identification for item management — Part 63: Parameters for air interface communications at 860 MHz to 960 MHz Type C*
- *ISO/IEC 18000-3 Information technology — Radio frequency identification for item management — Part 3: Parameters for air interface communications at 13,56 MHz*
- **All sections:** *ISO/IEC 646: Information technology; ISO 7-bit coded character set for information interchange.*

5.1.3 Symbology identifiers

The symbology identifier is not encoded in the barcode but is generated by the decoder after decoding and is transmitted as a preamble to the data message.

All scanning equipment has the ability to recognise the symbology that has been scanned. Some scanners have the optional feature of being able to transmit a symbology identifier. The symbology identifier is a three-character data string comprising a flag character, code character and a modifier character. The symbology identifiers used in the GS1 system are shown in figure [5.1.3-2](#).

Figure 5.1.3-1. Structure of the symbology identifiers

Character	Description
] 	The flag character (which has an ASCII value of 93). This denotes that the two characters following it are Symbol Identifier characters.
c	The code character. This denotes the type of symbology.
m	The modifier character. This indicates the mode in which the symbology is used.



Note: If used, the symbology identifier is transmitted as a prefix to the data message.

Figure 5.1.3-2. ISO/IEC 15424 symbology identifiers used in the GS1 system

Symbology identifier (*)	Symbology format	Content
]E0	EAN-13, UPC-A, or UPC-E	13 digits
]E1	Two-digit add-on symbol	2 digits
]E2	Five-digit add-on symbol	5 digits
]E3	EAN-13, UPC-A, or UPC-E with add-on symbol (**)	15 or 18 digits
]E4	EAN-8	8 digits
]I1	ITF-14	14 digits
]C1	GS1-128	Standard AI element strings
]e0	GS1 DataBar	Standard AI element strings
]e1	GS1 Composite	Data packet containing the data following an encoded symbol separator character.
]e2	GS1 Composite	Data packet containing the data following an escape mechanism character.
]d2	GS1 DataMatrix	Standard AI element strings
]Q3	GS1 QR Code	Standard AI element strings
]J1	GS1 DotCode	Standard AI element strings
]d1	Data Matrix implementing ECC 200	GS1 Digital Link URI
]Q1	QR Code	GS1 Digital Link URI

(*) Symbology identifiers are case sensitive.

(**) Barcodes with add-on symbols may be considered either as two separate symbols, each of which is transmitted separately with its own symbology identifier, or as a single data packet. The system designer SHALL select one of these methods, but the method using symbology identifier **]E3** is preferable for data security.

5.2 Linear barcodes - EAN/UPC symbology specifications

5.2.1 Symbology characteristics

Characteristics of barcodes in the EAN/UPC symbology family include:

- Encodable character set: digits (0 through 9) in accordance with *ISO/IEC 646*: Refer to figure [7.11-1](#) for more details.
- Symbology type: continuous.
- Symbol character density: seven modules per symbol character.
- Four elements per symbol character comprising two bars (dark bars) and two spaces (light bars), each of one, two, three, or four modules in width (auxiliary guard patterns have differing numbers of elements).
- Character self-checking.
- Fixed data string length encodable: 8, 12, or 13 characters including check digit, depending on specific symbol type.
- Omnidirectionally decodable.
- One mandatory check digit (described in section [7.9](#)).
- Non-data overhead not including the check digit or Quiet Zones:
 - 11 modules for EAN-13, EAN-8 and UPC-A barcodes (left guard bar pattern/centre guard bar pattern/right guard bar pattern).
 - Nine modules for UPC-E barcodes (left guard bar pattern/right guard bar pattern).

5.2.1.1 Symbol types

The barcodes in the EAN/UPC symbology family are:

- EAN-13, UPC-A and UPC-E barcodes, all of which may be accompanied by an add-on symbol.
- EAN-8 barcode.

The four symbol types are described in sections [5.2.2.1](#), [5.2.2.2](#), [5.2.2.3](#) and [5.2.2.4](#). The optional add-on symbols are described in section [5.2.2.5](#).

5.2.1.2 Symbol encodation

5.2.1.2.1 Symbol character encodation

Symbol characters SHALL encode digit values in seven module characters selected from different number sets known as A, B and C as shown in the figure below.

Figure 5.2.1.2.1-1. Number sets A, B and C

Digit value	Set A element widths				Set B element widths				Set C element widths			
	S	B	S	B	S	B	S	B	B	S	B	S
0	3	2	1	1	1	1	2	3	3	2	1	1
1	2	2	2	1	1	2	2	2	2	2	2	1
2	2	1	2	2	2	2	1	2	2	1	2	2
3	1	4	1	1	1	1	4	1	1	4	1	1
4	1	1	3	2	2	3	1	1	1	1	3	2
5	1	2	3	1	1	3	2	1	1	2	3	1
6	1	1	1	4	4	1	1	1	1	1	1	4
7	1	3	1	2	2	1	3	1	1	3	1	2
8	1	2	1	3	3	1	2	1	1	2	1	3
9	3	1	1	2	2	1	1	3	3	1	1	2

S denotes a space (light bar), **B** denotes a bar (dark bar) and the element widths are in modules.

Figure 5.2.6.1-1 graphically illustrates figure 5.2.1.2.1-1. The sum of the bar (dark bar) modules in any symbol character determines its parity. Symbol characters in number set A are odd parity characters. Symbol characters in number sets B and C are even parity characters. Number set C characters are mirror images of number set B characters.

Symbol characters in number sets A and B always begin on the left with a space module and end on the right with a dark module. Symbol characters in number set C begin on the left with a dark module and end on the right with a light module.

A data character shall normally be represented by a symbol character. However, in certain specific instances defined in sections 5.2.2.1, 5.2.2.4 and 5.2.2.5, the combination of number sets in a symbol may itself represent either data or a check digit value. This technique is referred to as variable parity encodation.

5.2.1.2.2 Auxiliary pattern encodation

Auxiliary patterns SHALL be composed as shown in figure 5.2.1.2.2-1.

Figure 5.2.1.2.2-1. Auxiliary patterns

Auxiliary pattern	Number of modules	Element widths in modules					
		S	B	S	B	S	B
Normal guard bar pattern	3		1	1	1		
Centre guard bar pattern	5	1	1	1	1	1	
Special guard bar pattern	6	1	1	1	1	1	1
Add-on guard bar pattern	4		1	1	2		
Add-on delineator	2	1	1				

S denotes a space (light) element and **B** denotes a bar (dark) element.

Section 5.2.6.2 graphically illustrates these patterns.

The normal guard bar pattern corresponds to the start and stop patterns in other symbologies and the special guard bar pattern is used as a stop pattern in UPC-E barcodes.

5.2.2 Symbol formats

5.2.2.1 EAN-13 barcodes

The EAN-13 barcode SHALL be made up as follows, reading from left to right:

- A left Quiet Zone.
- A normal guard bar pattern.
- Six symbol characters from number sets A and B.
- A centre guard bar pattern.
- Six symbol characters from number set C.
- A normal guard bar pattern.
- A right Quiet Zone.

The rightmost symbol character SHALL encode the check digit calculated in accordance with section 7.9.

Since the EAN-13 barcode comprises only 12 symbol characters but encodes 13 digits of data (including the check digit), the value of the additional digit, which is the character in the leftmost position in the data string, SHALL be encoded by the variable parity mix of number sets A and B for the six symbol characters in the left half of the symbol. The numbering system for values of the leading digit is specified in figure 5.2.2.1-1. Figure 5.2.2.1-2 is an example of an EAN-13 barcode.

Figure 5.2.2.1-1. Left half of an EAN-13 barcode

Leading digit, implicitly encoded	Number sets used for numbering left half of an EAN-13 barcode					
	Symbol character position					
	1	2	3	4	5	6
0*	A	A	A	A	A	A
1	A	A	B	A	B	B
2	A	A	B	B	A	B
3	A	A	B	B	B	A
4	A	B	A	A	B	B
5	A	B	B	A	A	B
6	A	B	B	B	A	A
7	A	B	A	B	A	B
8	A	B	A	B	B	A
9	A	B	B	A	B	A

* The leading digit value "0" is reserved for symbols encoding GTIN-12 element strings.

Figure 5.2.2.1-2. EAN-13 barcode



5.2.2.2 EAN-8 barcodes

The EAN-8 barcode SHALL be made up as follows, reading from left to right:

- A left Quiet Zone.
- A normal guard bar pattern.
- Four symbol characters from number set A.
- A centre guard bar pattern.
- Four symbol characters from number set C.
- A normal guard bar pattern.
- A right Quiet Zone.

The rightmost symbol character SHALL encode the check digit calculated in accordance with section 7.9. Figure 5.2.2.2-1 is an example of an EAN-8 barcode.

Figure 5.2.2.2-1. EAN-8 barcode



5.2.2.3 UPC-A barcodes

The UPC-A barcode SHALL be made up as follows, reading from left to right:

- A left Quiet Zone.

- A normal guard bar pattern.
- Six symbol characters from number set A.
- A centre guard bar pattern.
- Six symbol characters from number set C.
- A normal guard bar pattern.
- A right Quiet Zone.

The rightmost symbol character SHALL encode the check digit calculated in accordance with section [7.9](#). A UPC-A barcode may be decoded as a 13-digit number by adding an implied leading zero to the GTIN-12. Figure [5.2.2.3-1](#) is an example of a UPC-A barcode.

Figure 5.2.2.3-1. UPC-A barcode



5.2.2.4 UPC-E barcodes

The UPC-E barcode SHALL be made up as follows, reading from left to right:

- A left Quiet Zone.
- A normal guard bar pattern.
- Six symbol characters from number sets A and B.
- A special guard bar pattern.
- A right Quiet Zone.

The UPC-E barcode may only be used to encode GTIN-12 element strings that commence with a zero and contain a sequence of four or five zeroes in defined positions, as shown in figure [5.2.2.4-1](#). These zeroes are removed from the data during encoding by the zero-suppression process described in section [5.2.2.4.1](#). Figure [5.2.2.4-1](#) is an example of a UPC-E barcode.

Figure 5.2.2.4-1. UPC-E barcode
(encoding 012345000058 by zero-suppression)



5.2.2.4.1 Encodation of the UPC-E barcode

The following algorithm describes the encodation of a data string suitable for zero-suppression:

- Let D1, D2 and D3 through D12 denote the GTIN-12 data characters (including check digit). D1 SHALL always be zero. D12 SHALL be the check digit calculated according to the algorithm in section [7.9](#). Let X1 and X2 through X6 denote the six symbol characters in the final UPC-E barcode. Convert D2 through D11 into a symbol character string by removing zeroes according to the following rules:

If	Then
<ul style="list-style-type: none"> ■ D11 equals 5, 6, 7, 8, or 9 ■ and D7 to D10 inclusive are all 0 ■ and D6 is not 0 	<ul style="list-style-type: none"> ■ D7 to D10 are not encoded. ■ Symbol character: X1 X2 X3 X4 X5 X6 ■ Data character: D2 D3 D4 D5 D6 D11

If	Then
<ul style="list-style-type: none"> ■ D6 to D10 inclusive are all 0 ■ and D5 is not 0 	<ul style="list-style-type: none"> ■ D6 to D10 are not encoded and X6 = 4. ■ Symbol character: X1 X2 X3 X4 X5 X6 ■ Data character: D2 D3 D4 D5 D11 4

If	Then
<ul style="list-style-type: none"> ■ D4 is 0, 1, or 2 ■ and D5 to D8 inclusive are all 0 	<ul style="list-style-type: none"> ■ D5 to D8 are not encoded. ■ Symbol character: X1 X2 X3 X4 X5 X6 ■ Data character: D2 D3 D9 D10 D11 D4

If	Then
<ul style="list-style-type: none"> ■ D4 is 3, 4, 5, 6, 7, 8, or 9 ■ and D5 to D9 inclusive are all 0 	<ul style="list-style-type: none"> ■ D5 to D9 are not encoded and X6 = 3. ■ Symbol character: X1 X2 X3 X4 X5 X6 ■ Data character: D2 D3 D4 D10 D11 3

Determine the number sets for the implicit encodation of D12 from figure 5.2.2.4.1-1. Encode symbol characters X1 to X6 using number sets A and B as determined in Step 3.

Figure 5.2.2.4.1-1. Number sets for implicit encodation of D12

Value of check digit D12	Number sets used for numbering a UPC-E barcode					
	Symbol Character Position					
	1	2	3	4	5	6
0	B	B	B	A	A	A
1	B	B	A	B	A	A
2	B	B	A	A	B	A
3	B	B	A	A	A	B
4	B	A	B	B	A	A
5	B	A	A	B	B	A
6	B	A	A	A	B	B
7	B	A	B	A	B	A
8	B	A	B	A	A	B
9	B	A	A	B	A	B

Figure 5.2.2.4.1-2. Zero suppression example 1

Example 1	Original data	Zero-suppressed	Rule
	0 1 2 3 4 5 0 0 0 0 5 8	1 2 3 4 5 5	2a
		B A B A A B	

Figure 5.2.2.4.1-3. Zero suppression example 2

Example 2	Original data	Zero-suppressed	Rule
	0 4 5 6 7 0 0 0 0 8 0	4 5 6 7 8 4	2b
		B B B A A A	

Figure 5.2.2.4.1-4. Zero suppression example 3

Example 3	Original data	Zero-suppressed	Rule
	0 3 4 0 0 0 0 5 6 7 3	3 4 5 6 7 0	2c
		B B A A A B	

Figure 5.2.2.4.1-5. Zero suppression example 4

Example 4	Original data	Zero-suppressed	Rule
	0 9 8 4 0 0 0 0 7 5 1	9 8 4 7 5 3	2d
		B B A B A A	

Note: The number sets used to implicitly encode the check digit are shown in the zero-suppressed column.

5.2.2.4.2 Decoding a UPC-E barcode

Derivation of the 12-digit data string from the characters encoded in the UPC-E barcode SHALL be performed according to figure [5.2.2.4.2-1](#).

Figure 5.2.2.4.2-1. Decoding a UPC-E barcode

Encoded UPC-E barcode digits								Decoded number											
	P1	P2	P3	P4	P5	P6		D1	D2	D3	D4	D5	D6	D7	D8	D9	D10	D11	D12
(0)	X1	X2	X3	X4	X5	0	(C)	(0)	X1	X2	0	<u>0</u>	<u>0</u>	<u>0</u>	<u>0</u>	X3	X4	X5	(C)
(0)	X1	X2	X3	X4	X5	1	(C)	(0)	X1	X2	1	<u>0</u>	<u>0</u>	<u>0</u>	<u>0</u>	X3	X4	X5	(C)
(0)	X1	X2	X3	X4	X5	2	(C)	(0)	X1	X2	2	<u>0</u>	<u>0</u>	<u>0</u>	<u>0</u>	X3	X4	X5	(C)
(0)	X1	X2	X3	X4	X5	3	(C)	(0)	X1	X2	X3	<u>0</u>	<u>0</u>	<u>0</u>	<u>0</u>	X4	X5	(C)	
(0)	X1	X2	X3	X4	X5	4	(C)	(0)	X1	X2	X3	X4	<u>0</u>	<u>0</u>	<u>0</u>	<u>0</u>	X5	(C)	
(0)	X1	X2	X3	X4	X5	5	(C)	(0)	X1	X2	X3	X4	X5	<u>0</u>	<u>0</u>	<u>0</u>	<u>0</u>	5	(C)
(0)	X1	X2	X3	X4	X5	6	(C)	(0)	X1	X2	X3	X4	X5	<u>0</u>	<u>0</u>	<u>0</u>	<u>0</u>	6	(C)
(0)	X1	X2	X3	X4	X5	7	(C)	(0)	X1	X2	X3	X4	X5	<u>0</u>	<u>0</u>	<u>0</u>	<u>0</u>	7	(C)
(0)	X1	X2	X3	X4	X5	8	(C)	(0)	X1	X2	X3	X4	X5	<u>0</u>	<u>0</u>	<u>0</u>	<u>0</u>	8	(C)
(0)	X1	X2	X3	X4	X5	9	(C)	(0)	X1	X2	X3	X4	X5	<u>0</u>	<u>0</u>	<u>0</u>	<u>0</u>	9	(C)

Notes:

- The symbol characters at positions P1 and P2 through P5 of the UPC-E barcode are represented by X1 and X2 through X5.
- Re-inserted zeroes are indicated by underlining.
- The leading digit for UPC-E barcodes, which is not encoded, is indicated by "0".
- The check digit implicitly encoded in UPC-E barcodes is indicated by "C".

5.2.2.5 Add-on symbols

The add-on symbols were designed for use with EAN/UPC symbols on periodicals, hardback and paperback books. Because they provide reduced security, use of add-on symbols SHALL be limited to applications where rules in the application specification governing data format and content provide appropriate safeguards.

5.2.2.5.1 Two-digit add-on symbol

A two-digit add-on symbol may be used in specific applications to accompany an EAN-13, UPC-A, or UPC-E barcode. The two-digit add-on symbol is positioned following the right Quiet Zone of the main symbol and consists of the following:

- Add-on guard bar pattern.
- First digit of the additional number from number sets A or B.
- Add-on delineator.
- Second digit of the additional number from number sets A or B.
- A right Quiet Zone.

The add-on symbol has no right guard bar pattern. It does not have an explicit check digit. Checking is done through the mix of the number sets (A or B) used for the two digits. The choice of number sets is linked to the value of the additional number as shown by figure [5.2.2.5.1-1](#).

Figure 5.2.2.5.1-1. Number sets for five-digit add-on symbols

Value of the digits carried by the add-on symbol	Left-hand digit	Right-hand digit
Multiple of 4 (00,04,08,..96)	A	A
Multiple of 4+1 (01,05,..97)	A	B
Multiple of 4+2 (02,06,..98)	B	A
Multiple of 4+3 (03,07,..99)	B	B

Figure [5.2.2.5.1-2](#) is an example of an EAN-13 barcode with a two-digit add-on symbol.

Figure 5.2.2.5.1-2. EAN-13 barcode with two-digit add-on symbol



5.2.2.5.2 Five-digit add-on symbol

A five-digit add-on symbol may be used in specific applications to accompany an EAN-13, UPC-A, or UPC-E barcode. The five-digit add-on symbol is positioned following the right Quiet Zone of the main symbol and consists of the following:

1. Add-on guard bar pattern.
2. First digit of the add-on number from number sets A or B.
3. Add-on delineator.
4. Second digit of the add-on number from number sets A or B.
5. Add-on delineator.
6. Third digit of the add-on number from number sets A or B.
7. Add-on delineator.
8. Fourth digit of the add-on number from number sets A or B.
9. Add-on delineator.
10. Fifth digit of the add-on number from number sets A or B.
11. A right Quiet Zone.

The add-on symbol has no right guard bar pattern. It does not have an explicit check digit. Checking is done through the mix of the number sets (A or B) used for the five digits. A value V is determined by the following procedure:

1. Sum the digits in Positions one, three and five.
2. Multiply the result of step 1 by 3.
3. Sum the remaining digits (Positions two and four).
4. Multiply the result of step 3 by 9.
5. Sum the results of steps 2 and 4.
6. The value of V is the unit's position (lowest-order digit) of the result of step.

Example:

To calculate the value of V for an add-on symbol carrying the number 86104, follow these steps:

1. $8 + 1 + 4 = 13$
2. $13 \times 3 = 39$
3. $6 + 0 = 6$
4. $6 \times 9 = 54$
5. $39 + 54 = 93$
6. $V = 3$

The number sets can then be determined by using figure [5.2.2.5.2-1](#).

Figure 5.2.2.5.2-1. Number sets for five-digit add-on symbol

Value of V	Number sets used for symbol characters				
	1	2	3	4	5
0	B	B	A	A	A
1	B	A	B	A	A
2	B	A	A	B	A
3	B	A	A	A	B
4	A	B	B	A	A
5	A	A	B	B	A
6	A	A	A	B	B
7	A	B	A	B	A
8	A	B	A	A	B
9	A	A	B	A	B

Since $V = 3$ in figure [5.2.2.5.2-1](#), the sequence of number sets used to encode the value 86104 is B A A A B.

Figure [5.2.2.5.2-2](#) shows an example of an EAN-13 barcode with a five-digit add-on symbol.

Figure 5.2.2.5.2-2. EAN-13 barcode with five-digit add-on symbol



5.2.3 Dimensions and tolerances

5.2.3.1 Nominal dimensions of characters

Barcodes can be printed at various densities to accommodate a variety of printing and scanning processes. The significant dimensional parameter is **X**, the ideal width of a single module element. The X-dimension must be constant throughout a given symbol.

The dimensions of EAN-13, UPC-A, EAN-8 and UPC-E barcodes are referenced to a defined set of dimensions referred to as the nominal size symbol. Refer to section [5.2.6.6](#) for dimensioned drawings of nominal size symbols.

The X-dimension at nominal size is 0.330 millimetre (0.0130 inch).

The width of each bar (dark bar) and space (light bar) is determined by multiplying the X-dimension by the module width of each bar (dark bar) and space (light bar) (1, 2, 3 or 4). There is an exception for characters 1, 2, 7 and 8. For these characters, the bars (dark bars) and spaces (light bars) are reduced or enlarged by one-thirteenth of a module to provide a uniform distribution of bar width tolerances and thus improve scanning reliability.

The reduction or enlargement in millimetres at nominal size of the bars (dark bars) and spaces (light bars) for the characters 1, 2, 7 and 8 in the number sets A, B and C is shown in figure [5.2.3.1-1](#).

Figure 5.2.3.1-1. Reduction/enlargement for characters 1, 2, 7 and 8

Character value	Number set A		Number sets B and C	
	Bar (dark bar) mm	Space (light bar) mm	Bar (dark bar) mm	Space (light bar) mm
1	- 0.025	+0.025	+0.025	- 0.025
2	- 0.025	+0.025	+0.025	- 0.025
7	+0.025	- 0.025	- 0.025	+0.025
8	+0.025	- 0.025	- 0.025	+0.025

 **Note:** The existing symbol generation equipment that uses a value of 0.030 millimetre for the reduction/enlargement factor at nominal size will continue to be used for the foreseeable future.

5.2.3.2 Symbol height

For EAN-13, UPC-A and UPC-E barcodes the height of the symbol at the nominal size is 22.85 millimetres (0.900 inch). For EAN-8 barcodes the height of the symbol at the nominal size is 18.23 millimetres (0.718 inch).

The height of any two-digit or five-digit add-on symbol used must not extend outside the symbol height dimensions of the main symbol.

In EAN-13, EAN-8, UPC-A and UPC-E barcodes, the bars (dark bars) forming the left, centre and right guard bar patterns SHALL be extended downward by 5x (e.g., 1.65 millimetres (0.065 inch)). This SHALL also apply to the bars (dark bars) of the first and last symbol characters of the UPC-A barcode.

 **Note:** The height of an EAN/UPC barcode no longer includes the human readable interpretation and is the height of the bars only. The measurement of bar height does not include the extended height of either the guard patterns in EAN/UPC barcodes or the first and last symbol characters of a UPC-A barcode.

Symbol height is not modular.

5.2.3.3 X-dimension (magnification factor)

In the past the term "magnification factor" was extensively used to specify the size of a barcode. This technique relied upon setting a nominal size (100 percent) that was directly related to a given X-dimension. Since January 2000, the term "X-dimension" has been used to specify permissible symbol sizes (see section 5.12). The X-dimension of an add-on symbol SHALL be the same as the X-dimension of its associated main symbol.

5.2.3.4 Quiet Zone

The minimum Quiet Zone width required by the main symbol is 7x. However, other minimum Quiet Zone dimensions are specified for some symbol types due to the size and location of their human readable interpretation. These dimensions are noted in figure 5.2.3.4-1.

Figure 5.2.3.4-1. Quiet Zone widths by version

Symbol version	Left Quiet Zone		Right Quiet Zone	
	Modules	mm*	Modules	mm
EAN-13	11	3.63	7	2.31
EAN-8	7	2.31	7	2.31
UPC-A	9	2.97	9	2.97
UPC-E	9	2.97	7	2.31
Add-ons (EAN)	7-12	2.31-3.96	5	1.65
Add-ons (U.P.C.)	9-12	2.97-3.96	5	1.65

* This is an example using an X-dimension of 0.330 millimetres.



Note: A useful device to help maintain the Quiet Zone in some production processes is to include a less than (<) and/or greater than (>) character in the human readable interpretation field, with its apex aligned with the edge of the Quiet Zone. If this device is used, the character(s) SHALL be positioned in accordance with the appropriate drawings in section 5.2.6.6.

5.2.3.5 Symbol length

The symbol length in modules, including the minimum Quiet Zones, SHALL be as indicated in the figure below.

Figure 5.2.3.5-1. Symbol length in modules

Symbol type	Length
EAN-13	113
UPC-A	113
EAN-8	81
UPC-E	67
Two-digit add-on	25
Five-digit add-on	52
EAN-13 or UPC-A and two-digit add-on	138
UPC-E and two-digit add-on	92
EAN-13 or UPC-A and five-digit add-on	165
UPC-E and five-digit add-on	119

5.2.3.6 Positioning of the add-on symbol

The add-on symbol SHALL NOT encroach on the right Quiet Zone of the main symbol. The maximum separation SHALL be 12X. The bottom edge of the bars (dark bars) in the add-on symbol SHALL be horizontally aligned with the bottom edge of the guard bars of the main symbol.

5.2.4 Reference decode algorithm

Decode algorithms are used by scanning equipment to convert the bar and space patterns of the barcode into data characters. As a matter of policy, GS1 makes no attempt to specify or standardise equipment beyond stating that it should be capable of reading symbols produced in accordance with the specifications laid out in this manual.

Barcode reader systems are designed to read imperfect symbols to the extent that practical algorithms permit. This section describes the reference decode algorithm used to determine decode and decodability in symbol verification in accordance with *ISO 15416*.

For each symbol character, let S equal the total measured width of the character. The value S is used to determine reference threshold (RT) values. Individual edge to similar edge measurements (e) are then compared to the reference threshold to determine E values. Character values are determined from E values.

Value e_1 is defined as the measurement from the leading edge of a bar (dark bar) to the leading edge of the adjacent bar (dark bar). Value e_2 is defined as the measurement from the trailing edge of a bar (dark bar) to the trailing edge of the adjacent bar (dark bar). For number sets A and B, the right edge of each of the two bars (dark bars) is considered to be leading, while for number set C, the left edge of each bar (dark bar) is considered to be leading. These relationships are illustrated in the figure below.

Figure 5.2.4-1. Symbol character decode measurements

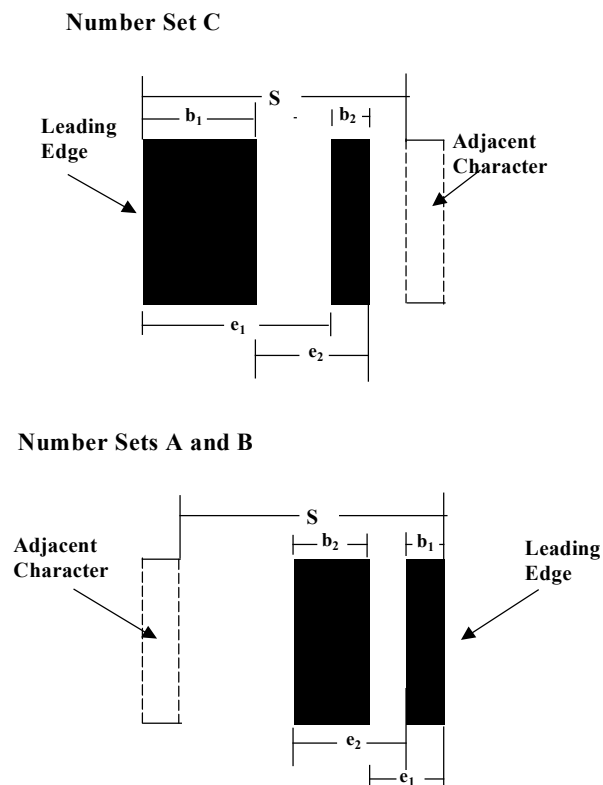

Reference thresholds RT1, RT2, RT3, RT4 and RT5 are given by:

- RT1 = $(1.5/7)S$
- RT2 = $(2.5/7)S$
- RT3 = $(3.5/7)S$
- RT4 = $(4.5/7)S$
- RT5 = $(5.5/7)S$

Within each character, the measurements e_1 and e_2 are compared with the reference thresholds. The corresponding integer values E_1 and E_2 are considered to be equal to 2, 3, 4, or 5 as follows:

- If $RT_1 \leq e_i < RT_2$, $E_i = 2$
- If $RT_2 \leq e_i < RT_3$, $E_i = 3$
- If $RT_3 \leq e_i < RT_4$, $E_i = 4$
- If $RT_4 \leq e_i < RT_5$, $E_i = 5$

Otherwise the character is in error.

Figure 5.2.4-2, use the values of E_1 and E_2 as the primary determinant for the symbol character value.

Figure 5.2.4-2. Barcode decoding

Character	Number set	Primary determinant		Secondary determinant $7(b_1 + b_2)/S$
		E_1	E_2	
0	A	2	3	
1	A	3	4	≤ 4
2	A	4	3	≤ 4
3	A	2	5	
4	A	5	4	
5	A	4	5	
6	A	5	2	
7	A	3	4	>4
8	A	4	3	>4
9	A	3	2	
0	B and C	5	3	
1	B and C	4	4	>3
2	B and C	3	3	>3
3	B and C	5	5	
4	B and C	2	4	
5	B and C	3	5	
6	B and C	2	2	
7	B and C	4	4	≤ 3
8	B and C	3	3	≤ 3
9	B and C	4	2	
b ₁ and b ₂ are the widths of the two bar (dark bar) elements				

The character is uniquely determined for all combinations of E_1 and E_2 except for the following four cases:

- $E_1 = 3$ and $E_2 = 4$ (characters 1 and 7 in number set A).
- $E_1 = 4$ and $E_2 = 3$ (characters 2 and 8 in number set A).
- $E_1 = 4$ and $E_2 = 4$ (characters 1 and 7 in number sets B and C).
- $E_1 = 3$ and $E_2 = 3$ (characters 2 and 8 in number sets B and C).

These cases require that the combined width of the two bars (dark bars) be tested as follows:

- For $E_1 = 3$ and $E_2 = 4$:
 - Character is 1 if $7 \times (b_1 + b_2) / S \leq 4$
 - Character is 7 if $7 \times (b_1 + b_2) / S > 4$
- For $E_1 = 4$ and $E_2 = 3$:

- Character is 2 if $7 \times (b1 + b2) / S \leq 4$
- Character is 8 if $7 \times (b1 + b2) / S > 4$
- For $E1 = 4$ and $E2 = 4$:
 - Character is 1 if $7 \times (b1 + b2) / S > 3$
 - Character is 7 if $7 \times (b1 + b2) / S \leq 3$
- For $E1 = 3$ and $E2 = 3$:
 - Character is 2 if $7 \times (b1 + b2) / S > 3$
 - Character is 8 if $7 \times (b1 + b2) / S \leq 3$

The requirements on $(b1 + b2)$ are shown in figure [5.2.4-2](#).

The same procedures SHALL be used to decode the symbol characters in any add-on symbol.

Use the figure below to determine the appropriate S measurement for calculating the reference threshold values $RT1$ and $RT2$ applicable to the auxiliary patterns of the main symbol. For each symbol or half symbol, the measurements of the appropriate auxiliary pattern e_i values are then compared to the reference thresholds to establish the integer E_i values. The determined values of $E1$, $E2$, $E3$ and $E4$ SHALL match those of valid auxiliary patterns as shown in figure [5.2.4-4](#). Otherwise the symbol is in error.

Figure 5.2.4-3. Auxiliary pattern measurements

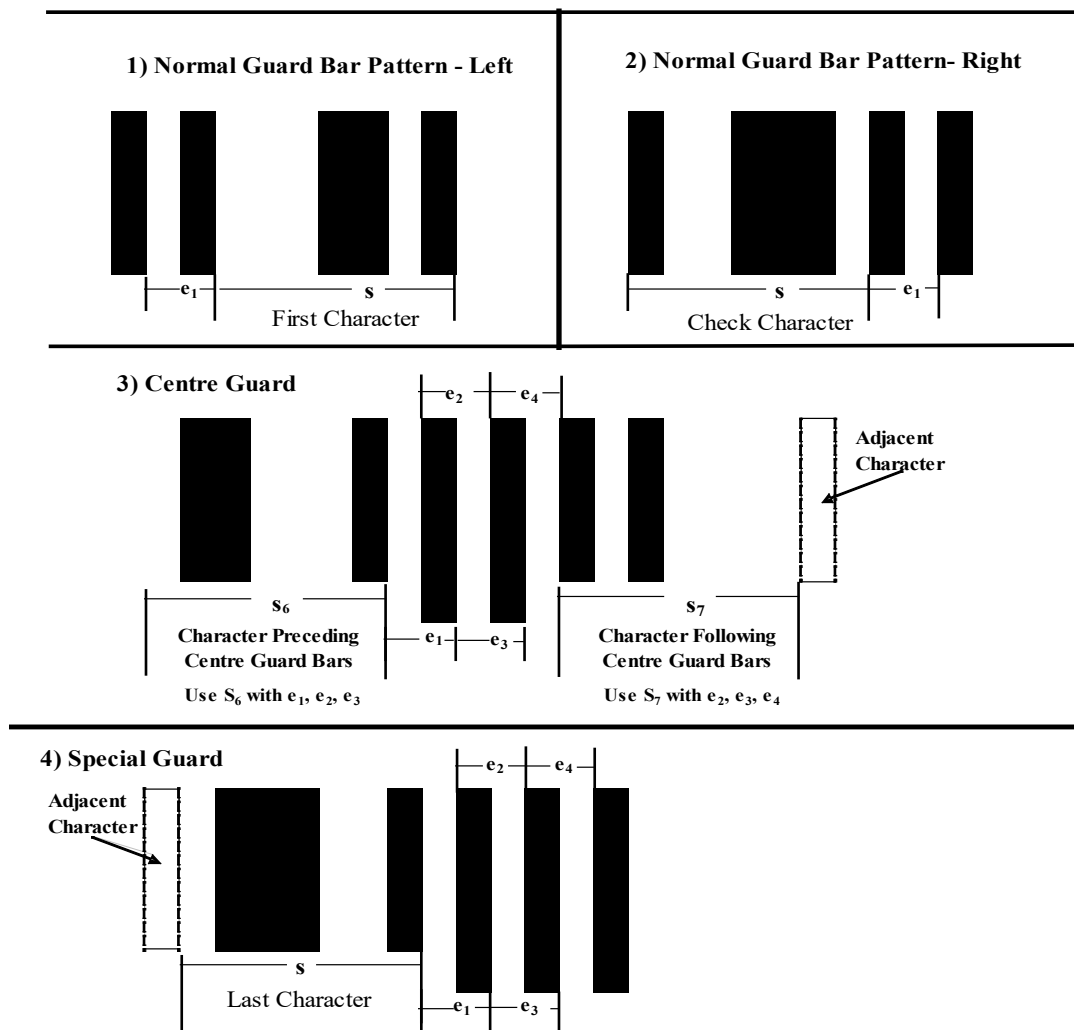

Figure 5.2.4-4. Main symbol auxiliary pattern E values

Auxiliary guard patterns	E1	E2	E3	E4
Normal guard bar pattern	2			
Centre guard bar pattern (left half)	2	2	2	
Centre guard bar pattern (right half)		2	2	2
Special guard bar pattern	2	2	2	2

5.2.5 Human readable interpretation

The human readable digits SHALL be printed underneath the main symbol and above the add-on symbol. A clearly legible font SHALL be used for these digits and OCR-B as defined in *ISO 1073-2: Alphanumeric character sets for optical recognition; Part 2: Character set OCR-B; Shapes and dimensions of the printed image*, is recommended. This font is referenced only as a convenient standard typeface and it is not intended that these characters be machine read or verified. Reasonable alternative type fonts and character sizes are acceptable provided the human readable interpretation is clearly legible.

All the encoded digits for EAN-13, UPC-A, EAN-8 barcodes and the add-on symbols SHALL be shown in human readable interpretation form. For UPC-E barcodes, the six digits directly encoded together with the leading zero and the implicitly encoded check digit SHALL be shown in human readable interpretation form. Figures [5.2.2.1-2](#), [5.2.2.2-1](#), [5.2.2.3-1](#), [5.2.2.4-1](#), [5.2.2.5.1-2](#) and [5.2.2.5.2-2](#) illustrate each type of symbol and its human readable interpretation.

The minimum space between the top of the digits and the bottom of the bars (dark bars) SHALL be 0.5X. Normally the minimum is one module, which is close enough to keep the human readable interpretation associated with the symbol.

In the EAN-13, the leftmost digit, which is encoded by variable parity, is printed to the left of the start guard pattern in line with the other digits.

For UPC-A and UPC-E barcodes, the size of the first and last digits should be reduced to a maximum width equivalent to four modules. The height is reduced proportionally. The right-hand side of the first digit is positioned five module widths to the left of the leftmost guard bar. The left-hand side of the last digit is positioned five module widths to the right of the rightmost guard bar for UPC-A barcodes and three module widths for UPC-E barcodes. The bottom edge of the first and last digit SHALL be aligned with the bottom edge of the remaining full size digits.





















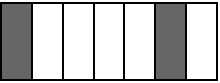





The human readable interpretation of the add-on symbol SHALL be above the symbol. The digits SHALL be the same height as those of the main symbol. The upper edges of the digits are aligned with the upper edges of the bars (dark bars) of the main symbol. The minimum space between the bottom of the digits and the top of the bars (dark bars) SHALL be 0.5X.

Some industries use specific variations of the recommended human readable interpretation, such as inserted hyphens to segment the number field.

5.2.6 Additional features

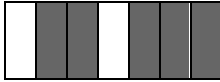
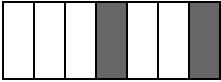
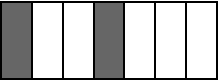

5.2.6.1 Character values in the EAN/UPC symbology family

Figure 5.2.6.1-1. Composition of EAN/UPC symbol characters

Value of character	Number set A (odd)	Number set B (even)	Number set C (even)
0			
1			
2			
3			
4			
5			
6			
7			
8			
9			

5.2.6.2 Auxiliary characters in the EAN/UPC symbology family

Figure 5.2.6.2-1. Composition of EAN/UPC auxiliary characters

Auxiliary character	
Normal guard bar pattern (right and left)	
Centre guard bar pattern	
UPC-E Right guard bar pattern	

5.2.6.3 Logical structure of an EAN-13 and UPC-A barcode excluding Quiet Zones

Figure 5.2.6.3-1. Logical structure of an EAN-13 or UPC-A barcode

Logical structure of an EAN-13 or UPC-A barcode (excluding Quiet Zones)				
Left guard bar pattern	Characters 12 through 7 (left half)	Centre guard bar pattern	Characters 6 through 1 (right half)	Right guard bar pattern
3 modules	42 modules (6x7)	5 modules	42 modules (6x7)	3 modules
Total number of modules = 95				

Figure 5.2.6.3-2. Combination of number sets representing the thirteenth character of an EAN-13

Value of the thirteenth character	Character position											
	Number set used for representing characters 12 through 7						Number set used for representing characters 6 through 1					
	12	11	10	9	8	7	6	5	4	3	2	1
0	A	A	A	A	A	A	ALWAYS USE NUMBER SET C					
1	A	A	B	A	B	B						
2	A	A	B	B	A	B						
3	A	A	B	B	B	A						
4	A	B	A	A	B	B						
5	A	B	B	A	A	B						
6	A	B	B	B	A	A						
7	A	B	A	B	A	B						
8	A	B	A	B	B	A						
9	A	B	B	A	B	A						

5.2.6.4 Logical structure of an EAN-8 Barcode excluding Quiet Zones

Figure 5.2.6.4-1. Logical structure of an EAN-8 barcode

Logical structure of an EAN-8 barcode (excluding Quiet Zones)				
Left guard bar pattern	Characters 8 Through 5 (Left Half)	Centre guard bar pattern	Characters 4 Through 1 (Right Half)	Right guard bar pattern
3 modules	28 modules (4x7)	5 modules	28 modules (4x7)	3 modules
Total number of modules = 67				

Figure 5.2.6.4-2. Number sets for EAN-8 barcode characters

Character position							
Number set used for representing characters 8 through 5				Number set used for representing characters 4 through 1			
8	7	6	5	4	3	2	1
ALWAYS USE NUMBER SET A				ALWAYS USE NUMBER SET C			

5.2.6.5 Logical structure of a UPC-E barcode excluding Quiet Zones

Figure 5.2.6.5-1. Logical structure of a UPC-E barcode

Logical Structure of a UPC-E Barcode (Excluding Quiet Zones)		
Normal guard bar pattern	Six Symbol Characters (Note the use of variable parity)	Special guard bar pattern (UPC-E)
3 modules	42 modules (6x7)	6 modules
Total number of modules = 51		

Figure 5.2.6.5-2. Number sets for UPC-E barcode characters

Value of prefix digit	Value of check digit	Number sets used for numbering a UPC-E barcode					
		1	2	3	4	5	6
0	0	B	B	B	A	A	A
0	1	B	B	A	B	A	A
0	2	B	B	A	A	B	A
0	3	B	B	A	A	A	B
0	4	B	A	B	B	A	A
0	5	B	A	A	B	B	A
0	6	B	A	A	A	B	B
0	7	B	A	B	A	B	A
0	8	B	A	B	A	A	B
0	9	B	A	A	B	A	B

5.2.6.6 Symbol dimensions at nominal size (X-dimension = 0.330 mm, not to scale)

All measurements in the following figures are in millimetres.

Figure 5.2.6.6-1. EAN-13 barcode

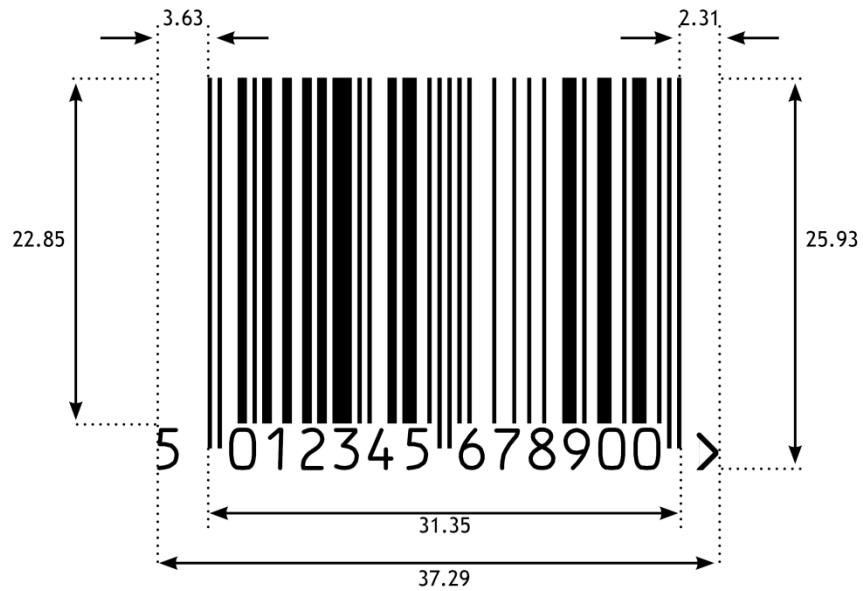

Figure 5.2.6.6-2. UPC-A barcode

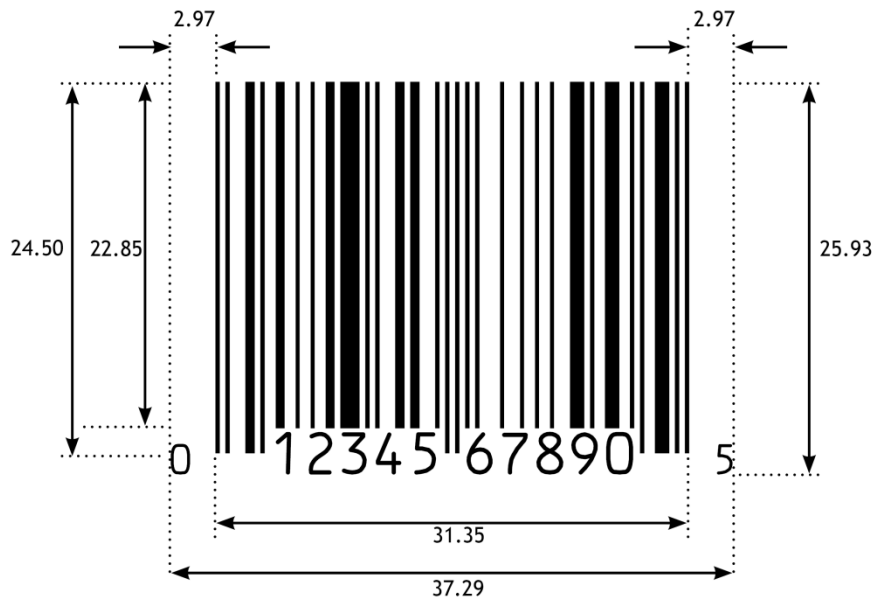

Figure 5.2.6.6-3. EAN-8 barcode



Figure 5.2.6.6-4. UPC-E barcode

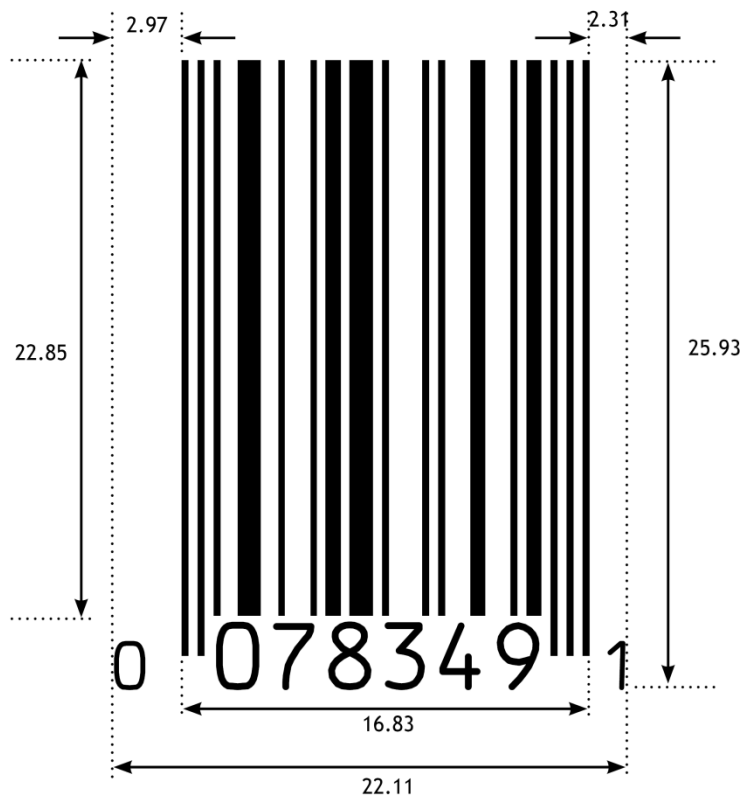

Figure 5.2.6.6-5. UPC-A barcode with two-digit add-on symbol



Figure 5.2.6.6-6. EAN-13 barcode with five-digit add-on symbol



5.2.6.7 Dimensions of modules and symbols

Minimum, target, and maximum module size are detailed in the GS1 symbol specification tables, section [5.12.3](#). The module size chosen SHOULD be selected with the recommendations offered in section [5.12.4.1.3](#) Symbol size will depend on the module size chosen.

5.3 Linear barcodes - ITF-14 symbology specifications

5.3.1 Symbology characteristics

In the GS1 system, the characteristics of ITF-14 symbols are:

- Encodable character set: digits 0 through 9, in accordance with *ISO/IEC 646*. Refer to figure [7.11-1](#) for more details.
- Code type: continuous.
- Elements per symbol character: five (two wide and three narrow) encoded as either five bars (dark bars) or five spaces (light bars).
- Self-checking symbol character.
- Data string length encodable: fixed length at 14 digits.
- Bidirectionally decodable.
- One check digit is required (see section [7.9](#)).
- The symbol character density for ITF-14 is 16 to 18 modules per symbol character pair, depending on the wide-to-narrow ratio. The value is 16, based on the target ratio of 2.5 to 1.
- The non-data overhead is eight to nine modules, depending on the wide-to-narrow ratio. The value is 8.5, based on the target ratio of 2.5 to 1.

5.3.2 Symbol structure

An ITF-14 symbol includes:

- A left Quiet Zone.
- A start pattern.
- Seven pairs of symbol characters representing data.
- A stop pattern.
- A right Quiet Zone.

5.3.2.1 Character encodation

5.3.2.1.1 Data character encodation

Figure [5.3.2.1.1-1](#) defines the ITF-14 symbol's character encodation. In the binary representation column, the character 1 represents a wide element and 0 represents a narrow element.

Figure 5.3.2.1.1-1. Binary representation of character encodation

Data character	Binary representation				
0	0	0	1	1	0
1	1	0	0	0	1
2	0	1	0	0	1
3	1	1	0	0	0
4	0	0	1	0	1
5	1	0	1	0	0

Data character	Binary representation				
6	0	1	1	0	0
7	0	0	0	1	1
8	1	0	0	1	0
9	0	1	0	1	0

Figure 5.3.2.1.1-1 uses a modified binary coded decimal encoding scheme. The four leftmost bit positions for each character are assigned weights of 1, 2, 4 and 7, from left to right; the fifth position is used for an even parity bit. The sum of the positional weights of the 1 bits is equivalent to the data character value, except in the case of data character 0, where the weights 4 and 7 are applied. The parity bit ensures that there are always two 1 bits per character.

The algorithm shown in figure 5.3.2.1.1-2 defines the rules for converting numeric data into the symbol characters of an ITF-14 symbol (numeric data equals the Global Trade Item Number (GTIN) and, therefore, already contains the check digit).

Figure 5.3.2.1.1-2. Rules for converting numeric data into symbol characters

Step in algorithm	Example
1. Calculate check digit for 0367123456789	367
2. With ITF-14 symbols, the data string, including the check digit, will always be a 14-digit number. The leftmost four digits of this number are 0367.	0367
3. Subdivide the numeric string into digit pairs. The leftmost four digits of the number are 0367.	0367 03 and 67
4. Encode the digit pairs as follows: <ul style="list-style-type: none"> ▪ Encode the leading digit of each pair into bar patterns, as shown in figure 5.3.2.1.1-1 ▪ Encode the second digit of each pair into space patterns, as shown in figure 5.3.2.1.1-1 	0 and 6 3 and 7
5. Form each symbol character pair by taking the bar (dark bar) and space (light bar) elements alternately from the patterns derived from the two steps in 4, commencing with the first bar (dark bar) of the pattern for the first digit, followed by the first space (light bar) of the pattern for the second digit.	

Figure 5.3.2.1.1-3 illustrates the sequence of bar (dark bar) and space (light bar) elements corresponding to the data character pairs 03 and 67.

Figure 5.3.2.1.1-3. ITF-14 symbol character pairs encoding 03 and 67

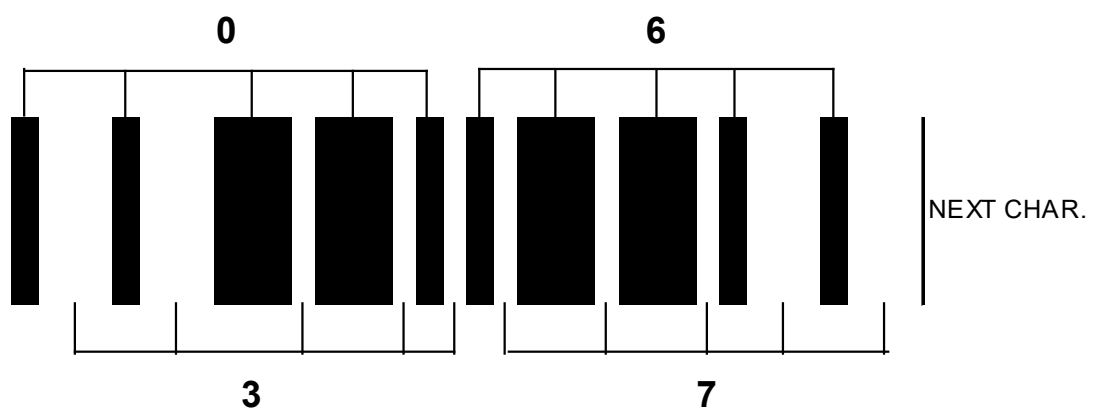

5.3.2.1.2 Start and stop patterns

The start pattern SHALL consist of four narrow elements in the sequence "bar (dark bar) - space (light bar) - bar (dark bar) - space (light bar)." The stop pattern SHALL consist of a "wide bar (dark bar) - narrow space (light bar) - narrow bar (dark bar)" sequence.

The start pattern SHALL be positioned at the normal left end of the symbol characters adjacent to the first bar (dark bar) of the most significant digit. The stop pattern SHALL be positioned at the normal right end of the symbol characters adjacent to the final space (light bar) of the least significant digit.

There is no assigned human readable interpretation of the start and stop patterns and they SHALL NOT be transmitted by the decoder. Figure 5.3.2.1.2-1 illustrates the start and stop patterns and their relationship to the symbol characters.

Figure 5.3.2.1.2-1. Start and stop patterns

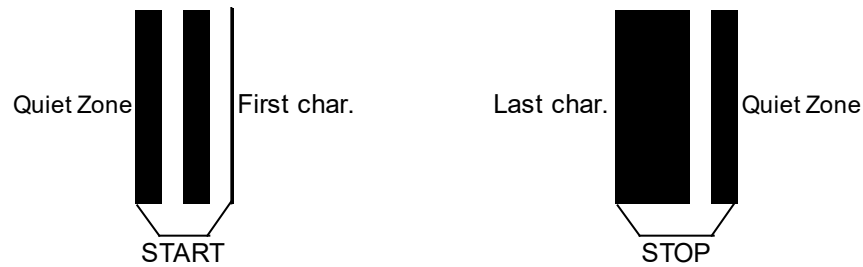
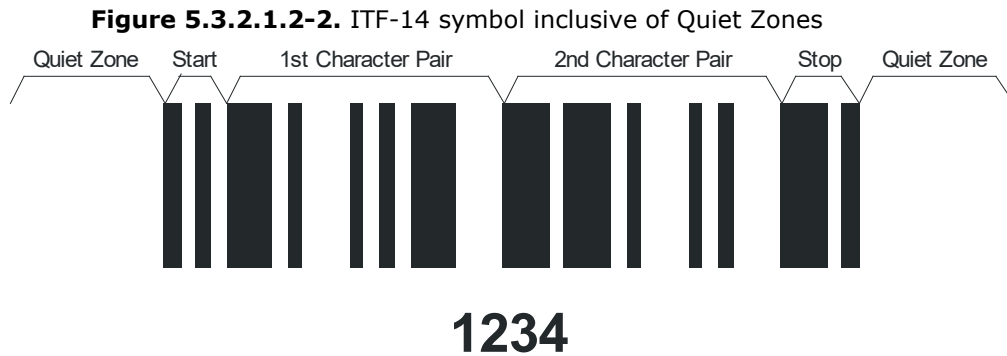

Figure 5.3.2.1.2-2 illustrates a complete barcode for the number 1234, showing the necessary Quiet Zones.



5.3.2.1.3 Check digit

A check digit is required in the ITF-14 symbology. Section 7.9 defines the check digit position and calculation.

5.3.2.2 Dimensions and tolerances

ITF-14 symbols SHALL use the following nominal dimensions:

- Width of narrow element (X): the X-dimension of ITF-14 symbols is defined by the application specification based on the needs of the application. Refer to section 5.12.2.6 for specifications by application area.
- The wide/narrow ratio (N): the range is 2.25:1 to 3.0:1 but the actual wide-to-narrow ratio is defined by the application specification based on the needs of the application. Refer to section 5.12.2.6 for specifications by application area.
- The Quiet Zones to the right and left of the symbol are compulsory. The minimum width of each Quiet Zone is 10X.
- A minimum space of 1.02 millimetre (0.040 inch) between the bottom line of the bearer bar and the top of the human readable characters is required.

The length of an ITF-14 symbol, including Quiet Zones, is calculated from the following expression:

$$W = (P(4N+6)+N+6)X+2Q$$

Where:

- **W** is the length in millimetres.
- **P** is the number of character pairs.
- **N** is the wide-to-narrow ratio.
- **X** is the width of a narrow element in millimetres.
- **Q** is the width of the Quiet Zone in millimetres.

As an example, for an ITF-14 symbol that has seven character pairs, a target wide-to-narrow ratio of 2.5:1, a target X width of 1.016 millimetres (0.0400 inch) and Quiet Zone widths of 10.16 millimetres (0.400 inch) the total symbol width is 142.75 millimetres (5.620 inches).

5.3.2.3 Reference decode algorithm

Barcode reading systems are designed to read imperfect symbols to the extent that practical algorithms permit. This section describes the reference decode algorithm used in the computation of the decodability value described in *ISO/IEC 15416*. Decodability SHALL be determined as follows:

- Within each ITF-14 symbol character (representing two digits), sort the bars (b_i) and spaces (s_i) such that:

$$\mathbf{b_1 < b_2 < b_3 < b_4 < b_5}$$

$$\mathbf{s_1 < s_2 < s_3 < s_4 < s_5}$$

- The determined X-dimension (Z) is given by:

$$\mathbf{Z = b_1 + b_2 + b_3 + s_1 + s_2 + s_3 / 6}$$

- Separation value (V_1) is:

$$\mathbf{V_1 = (d/Z) - 0.5}$$

where d = the smaller of ($b_4 - b_3$) or ($s_4 - s_3$)

- Uniformity value (V_2) is:

$$\mathbf{V_2 = 1 - u/Z}$$

where u = the largest of:

$$b_5 - b_4$$

$$b_3 - b_1$$

$$s_5 - s_4$$

$$s_3 - s_1$$

- Narrowest element value (V_3) is:

$$\mathbf{V_3 = [(n/Z) - 0.25] / 0.75}$$

where n = the smaller of s_1 or b_1

- For each symbol character, determine the decodability value V. V is the smallest of V_1 , V_2 , or V_3 .
- The scan profile decodability value is the smallest value of V measured in a Scan Reflectance Profile (SRP). The reference decode algorithm fails when V exhibits a negative value.
- The decodability grade for each profile is determined from the decodability value according to *ISO/IEC 15416*.

5.3.2.4 Bearer bars

The purpose of a bearer bar is to equalise the pressure exerted by the printing plate over the entire surface of the symbol and to enhance reading reliability by helping to reduce the probability of misreads or short scans that may occur when a skewed scanning beam enters or exits the barcode through its top or bottom edge.

The bearer bar is mandatory unless it is not technically feasible to apply it (in which case reading reliability will be reduced).

For printing methods requiring printing plates, the nominal bearer bar has a constant thickness of 4.83 millimetres (0.190 inch) and must completely surround the symbol, including its Quiet Zones and butt directly against the top and bottom of the bars (dark bars) of the symbol.

For printing methods that do not require printing plates, the bearer bar SHALL be a minimum of twice the width of a narrow bar (dark bar) and need only appear at the top and bottom of the symbol, butting directly against the top and bottom of the symbol bars (dark bars). The bearer bar may extend above and below the Quiet Zones. However, it is not mandatory to print the vertical sections of the bearer bar. See figure below.

Figure 5.3.2.4-1. ITF symbols with bearer bars



5.3.2.5 Human readable interpretation

For human readable interpretation rules see section [4.14](#). For HRI rules specific to regulated healthcare retail consumer trade items, see section [4.14.1](#).

5.3.3 Additional features (informative)

5.3.3.1 Protection against short scans

In ITF-14 symbols, the bar (dark bar) patterns of the start and stop patterns may be found at the respective end and beginning of certain encoded symbol characters within the code. There is, therefore, no guarantee that a partial scan of the symbol will not produce a valid read for an embedded symbol having fewer characters.

In the GS1 system, short scans are very unlikely to happen, as the symbol must always contain 14 digits. However, a symbol containing more than 14 digits may cause a short scan of 14 digits. In this instance, the check digit offers security to detect this error. These are the measures that SHALL be taken to minimise the risk of partial read.

5.3.3.2 Fixed length symbols

In any application standard, the number of characters encoded in an ITF-14 symbol SHALL be fixed for that application and reading or data processing equipment SHOULD be programmed to only accept messages of that defined length. An ITF-14 symbol must always carry a 14-digit number.

5.3.4 Guidelines for the use of ITF-14 (informative)

5.3.4.1 Autodiscrimination compatibility

ITF-14 symbols may be read by suitably programmed barcode readers that are designed to autodiscriminate the ITF-14 symbology from other symbologies. The ITF-14 symbology is fully distinguishable from and compatible with many symbologies including the ISO standard symbologies. The decoder's valid set of symbologies SHOULD be limited to those needed by a given application to maximise reading security.

5.3.4.2 System considerations

It is important that the various components making up a barcode installation system (e.g., printers, labels, readers) operate in concert. A failure in any component, or a mismatch between components, can compromise the performance of the overall system.

5.3.5 Symbology identifier (informative)

The symbology identifier allocated to the ITF-14 symbol in *ISO/IEC 15424*, which is added as a preamble to the decoded data by a suitably programmed barcode reader, is: **]Im**

where:

] is ASCII character 93.

I (upper case I) is the code character for the ITF-14 symbology.

m is a modifier character.



Note: The symbology identifier **]I1** is the only symbology identifier used by GS1 with the ITF-14 symbol. This information SHALL NOT be encoded in the barcode, but SHALL be generated by the decoder after decoding and transmitting as a preamble to the data message. The value of "m" in the symbology identifier is equal to 1, which indicates the check digit has been validated and transmitted by the scanner.

5.3.6 Test specifications (informative)

To verify whether a symbol meets the specifications of the GS1 system, it SHALL be tested using the specification defined in *ISO/IEC 15416*, which details the conditions under which measurements SHALL be made. The specification defines methods of determining an overall quality grade based on the attributes of the barcode and determining its conformity with the system. For ITF-14 symbols, the reference decode algorithm SHALL be the algorithm specified in section [5.3.2.3](#).

Full details on barcode production and quality assessment can be found in section [5.12](#).

The verifier SHALL determine the average wide-to-narrow ratio (N) for each profile. The value **N** is computed character by character, then averaged over all characters in the symbol. The range indicated below is passing:

2.25 < N < 3.00

N is calculated for each symbol character (pair of data digits) according to the following rule:

$N_i = 1.5 * [(b_4 + b_5 + s_4 + s_5) / (b_1 + b_2 + b_3 + s_1 + s_2 + s_3)]$

The value N for the profile is then obtained by averaging the N_i for all characters in the symbol.

Figure 5.3.6-1. ITF-14 symbol: Main dimensions at X-dimension 1.016 mm (0.0400 in.)

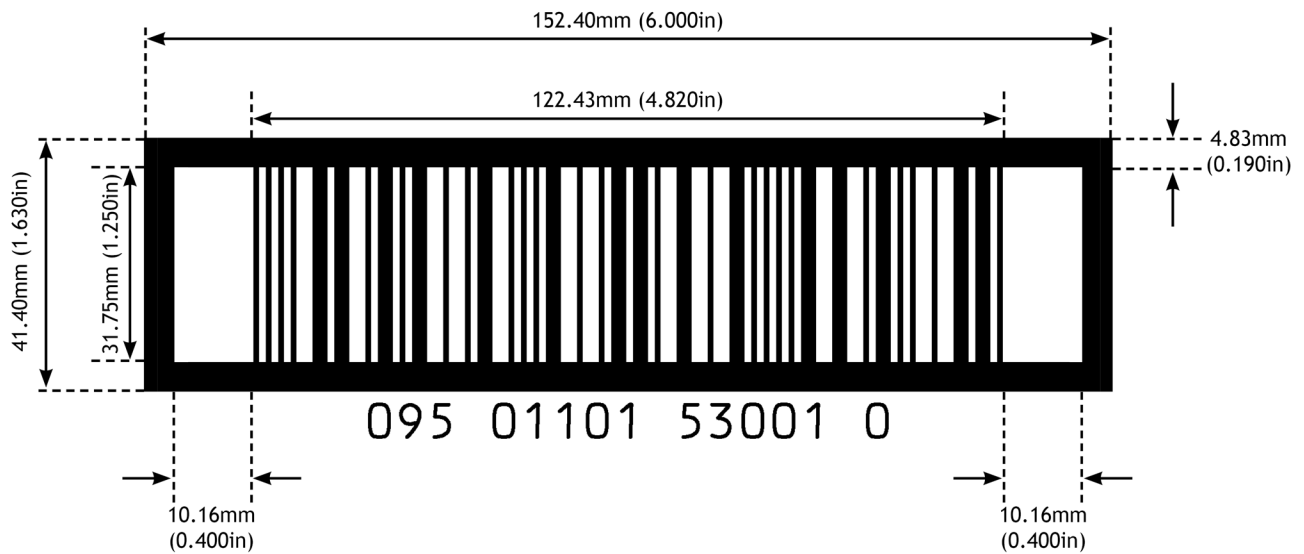

 **Note:** diagram is not intended to be used as a basis for measurement.

5.4 Linear barcodes - GS1-128 symbology specifications

The GS1-128 barcode has been carefully designed through joint co-operation between GS1 and AIM (Association for Automatic Identification and Mobility). Use of GS1-128 barcodes provides a high degree of security and distinguishes GS1 system element strings from extraneous non-standard barcodes.

The GS1-128 symbology is a subset of the more general Code 128 symbology. By agreement between AIM and GS1, use of the Function 1 Symbol Character (FNC1) in Code 128 symbols in the first symbol character position following the start character has been reserved exclusively for the GS1 system. Code 128 is fully described in *ISO/IEC 15417, Information Technology - Automatic Identification and Data Capture Techniques - Bar code Symbology Specification - Code 128*. The information covered in the *GS1 General Specifications* includes:

- Sections [5.4.1](#), [5.4.2](#), [5.4.3](#), [5.4.4](#), [5.4.5](#) and [5.4.6](#): GS1-128 symbology subset (using *ISO/IEC 15417* for reference).
- Section [5.4.7](#): GS1-128 symbology application parameters.
- Section [7.8](#): Processing of data from a GS1 symbology using GS1 Application Identifiers.

5.4.1 GS1-128 symbology characteristics

The characteristics of the GS1-128 symbology are:

- Encodable character set:
 - The GS1 system requires that only the subset of *ISO/IEC 646 International Reference Version* defined in these *GS1 General Specifications* be used for GS1 Application Identifier (AI) element strings. Refer to figure [7.11-1](#) for the allowed encodable character set.
 - Characters with ASCII values 128 to 255 may also be encoded in Code 128 symbols. Characters with ASCII values 128 to 255 accessed by Function 4 Symbol Character (FNC4) are reserved for future use and are not used in GS1-128 barcodes.
 - Four non-data function characters. FNC2 and FNC4 are not used in GS1-128 barcodes.
 - Four code set selection characters (including single character code set shift).
 - Three start characters.

- One stop character.
- Continuous code type.
- Six elements per symbol character comprising three bars (dark bars) and three spaces (light bars), each one, two, three, or four modules in width. The stop character is made up of seven elements comprising four bars (dark bars) and three spaces (light bars).
- Character self-checking.
- Variable symbol length.
- Bi-directionally decodable.
- One mandatory symbol check character (see section [5.4.3.6](#)).
- Data character density is 11 modules per symbol character (5.5 modules per numeric character in code set C, 13 modules per stop character).
- Non-data overhead:
 - GS1-128 barcodes have a special double character start pattern consisting of the appropriate start character and immediately followed by a Function 1 Symbol Character Code (FNC1). The FNC1 adds to the symbol's non-data overhead. The total symbol overhead is 46 modules.
 - The FNC1 character may also be used as a separator character between element strings not contained in the predefined table shown in figure [7.8.5-2](#).
- GS1-128 barcode size characteristics:
 - The maximum physical length is 165.10 millimetres (6.500 inch) including Quiet Zones.
 - The maximum number of data characters in a single symbol is 48.
 - For a given length of data, the symbol size is variable between limits in X-dimension to accommodate the ranges in quality achievable by the various printing processes.

5.4.2 GS1-128 barcode structure

The GS1-128 barcode is made up as follows, reading from left to right:

- Left Quiet Zone
- The double character start pattern:

A start character (A, B, or C)
The Function 1 Symbol Character (FNC1)
- Data (including the GS1 Application Identifier represented in character set A, B, or C).
- A symbol check character.
- The stop character.
- Right Quiet Zone.

For human readable interpretation rules see section [4.14](#). For HRI rules specific to regulated healthcare retail consumer trade items, see section [4.14.1](#).

Figure 5.4.2-1. General format of a GS1-128 barcode

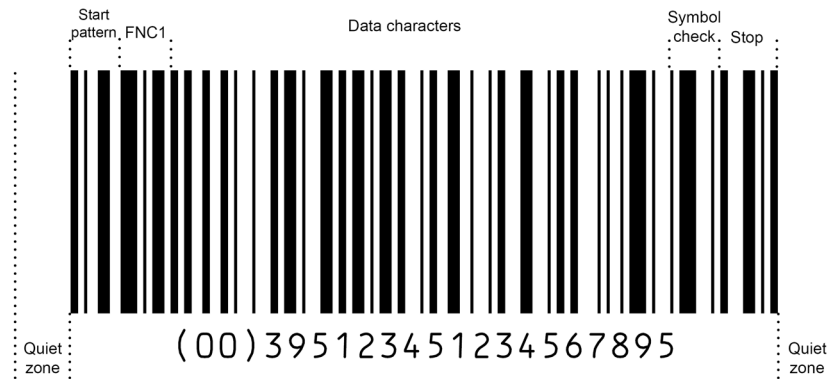

5.4.3 GS1-128 symbology character assignments

Figure 5.4.3.2-1 defines all the Code 128 character assignments. In the element width column, the numeric values represent the widths of the elements in modules or multiples of the X-dimension. GS1-128 barcode character assignments are identical to Code 128 symbol character assignments.

5.4.3.1 Symbol character structure

The sum of the bar modules in any symbol character is always even (even parity) and the sum of the space modules is, therefore, always odd. This parity feature enables character self-checking.

Figure 5.4.3.1-1. GS1-128 barcode start character A

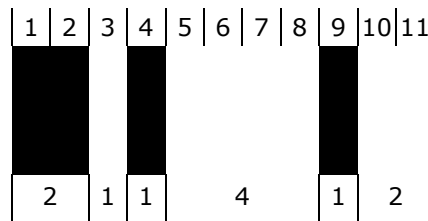

Figure 5.4.3.1-2 illustrates the encodation of one symbol character, which represents the single data character C in both code sets A or B or the two distinct data character digits 3 and 5 in code set C.

Figure 5.4.3.1-2. Symbol character value 35

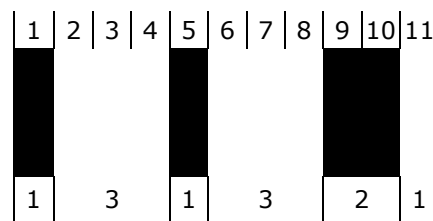
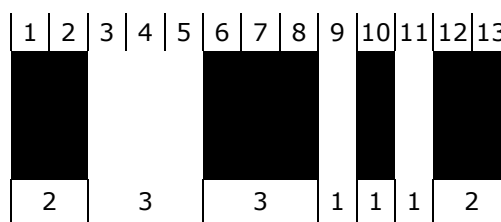

Figure 5.4.3.1-3. GS1-128 barcode stop character



5.4.3.2 Data character encodation

Code 128 has three character sets, which are shown in figure 5.4.3.2-1 as code sets A, B and C. GS1-128 symbology specifies a character subset of *ISO/IEC 646 International Reference Version* to ensure international compatibility. For more information see figure 7.11-1.

The symbol character bar (dark bar) and space (light bar) patterns shown in figure 5.4.3.2-1 represent the data characters listed under the columns for code set A, B, or C. Each symbol character in code set C encodes two data character digits or one of three auxiliary characters (code A, code B and Function 1). The choice of code set depends on the start character, the use of code A, code B or code C characters, or the shift character. If the symbol begins with start character A, then code set A is defined initially. Code set B and code set C are similarly defined by beginning the symbol with start character B or C, respectively. The code set can be redefined within the symbol by using code A, code B and code C characters or the shift character (see section 5.4.3 for the use of special characters).

The same data may be represented by different Code 128 symbols through the use of different combinations of start character, code set and shift characters. The individual applications do not specify code sets A, B, or C. section 5.4.7.6 contains rules to minimise the length of the symbol for any given data.

Each symbol character is assigned a numeric value listed in figure 5.4.3.2-1. This value is used in calculating the symbol check character value. It may also be used to provide a conversion to and from ASCII values (see section 5.4.7.6).

Figure 5.4.3.2-1. Code 128 character encodation

Symbol character value	Code set A	ASCII value for code set A	Code set B	ASCII value for code set B	Code set C	Element widths (Modules)						Element pattern										
						B	S	B	S	B	S	1	2	3	4	5	6	7	8	9	10	11
0	space	32	space	32	00	2	1	2	2	2	2											
1	!	33	!	33	01	2	2	2	1	2	2											
2	"	34	"	34	02	2	2	2	2	2	1											
3	#	35	#	35	03	1	2	1	2	2	3											
4	\$	36	\$	36	04	1	2	1	3	2	2											
5	%	37	%	37	05	1	3	1	2	2	2											
6	&	38	&	38	06	1	2	2	2	1	3											
7	apostrophe	39	apostrophe	39	07	1	2	2	3	1	2											
8	(40	(40	08	1	3	2	2	1	2											
9)	41)	41	09	2	2	1	2	1	3											
10	*	42	*	42	10	2	2	1	3	1	2											
11	+	43	+	43	11	2	3	1	2	1	2											
12	comma	44	comma	44	12	1	1	2	2	3	2											
13	-	45	-	45	13	1	2	2	1	3	2											
14	full stop	46	full stop	46	14	1	2	2	2	3	1											
15	/	47	/	47	15	1	1	3	2	2	2											
16	0	48	0	48	16	1	2	3	1	2	2											
17	1	49	1	49	17	1	2	3	2	2	1											
18	2	50	2	50	18	2	2	3	2	1	1											
19	3	51	3	51	19	2	2	1	1	3	2											
20	4	52	4	52	20	2	2	1	2	3	1											

Symbol character value	Code set A	ASCII value for code set A	Code set B	ASCII value for code set B	Code set C	Element widths (Modules)						Element pattern													
						B	S	B	S	B	S	1	2	3	4	5	6	7	8	9	10	11			
21	5	53	5	53	21	2	1	3	2	1	2	■			■			■							
22	6	54	6	54	22	2	2	3	1	1	2	■			■	■			■						
23	7	55	7	55	23	3	1	2	1	3	1	■			■			■			■				
24	8	56	8	56	24	3	1	1	2	2	2	■			■			■			■				
25	9	57	9	57	25	3	2	1	1	2	2	■			■			■			■				
26	colon	58	colon	58	26	3	2	1	2	2	1	■			■			■			■				
27	semi-colon	59	semi-colon	59	27	3	1	2	2	1	2	■			■			■			■				
28	<	60	<	60	28	3	2	2	1	1	2	■			■			■			■				
29	=	61	=	61	29	3	2	2	2	1	1	■			■			■			■				
30	>	62	>	62	30	2	1	2	1	2	3	■			■			■			■				
31	?	63	?	63	31	2	1	2	3	2	1	■			■			■			■				
32	@	64	@	64	32	2	3	2	1	2	1	■			■			■			■				
33	A	65	A	65	33	1	1	1	3	2	3	■			■			■			■				
34	B	66	B	66	34	1	3	1	1	2	3	■			■			■			■				
35	C	67	C	67	35	1	3	1	3	2	1	■			■			■			■				
36	D	68	D	68	36	1	1	2	3	1	3	■			■			■			■				
37	E	69	E	69	37	1	3	2	1	1	3	■			■			■			■				
38	F	70	F	70	38	1	3	2	3	1	1	■			■			■			■				
39	G	71	G	71	39	2	1	1	3	1	3	■			■			■			■				
40	H	72	H	72	40	2	3	1	1	1	3	■			■			■			■				
41	I	73	I	73	41	2	3	1	3	1	1	■			■			■			■				
42	J	74	J	74	42	1	1	2	1	3	3	■			■			■			■				
43	K	75	K	75	43	1	1	2	3	3	1	■			■			■			■				
44	L	76	L	76	44	1	3	2	1	3	1	■			■			■			■				
45	M	77	M	77	45	1	1	3	1	2	3	■			■			■			■				
46	N	78	N	78	46	1	1	3	3	2	1	■			■			■			■				
47	O	79	O	79	47	1	3	3	1	2	1	■			■			■			■				
48	P	80	P	80	48	3	1	3	1	2	1	■			■			■			■				
49	Q	81	Q	81	49	2	1	1	3	3	1	■			■			■			■				
50	R	82	R	82	50	2	3	1	1	3	1	■			■			■			■				
51	S	83	S	83	51	2	1	3	1	1	3	■			■			■			■				
52	T	84	T	84	52	2	1	3	3	1	1	■			■			■			■				
53	U	85	U	85	53	2	1	3	1	3	1	■			■			■			■				
54	V	86	V	86	54	3	1	1	1	2	3	■			■			■			■				
55	W	87	W	87	55	3	1	1	3	2	1	■			■			■			■				
56	X	88	X	88	56	3	3	1	1	2	1	■			■			■			■				
57	Y	89	Y	89	57	3	1	2	1	1	3	■			■			■			■				
58	Z	90	Z	90	58	3	1	2	3	1	1	■			■			■			■				
59	[91	[91	59	3	3	2	1	1	1	■			■			■			■				
60	\	92	\	92	60	3	1	4	1	1	1	■			■			■			■				

Symbol character value	Code set A	ASCII value for code set A	Code set B	ASCII value for code set B	Code set C	Element widths (Modules)						Element pattern															
						B	S	B	S	B	S	1	2	3	4	5	6	7	8	9	10	11					
61]	93]	93	61	2	2	1	4	1	1																
62	^	94	^	94	62	4	3	1	1	1	1																
63	_	95	_	95	63	1	1	1	2	2	4																
64	NUL	00	grave accent	96	64	1	1	1	4	2	2																
65	SOH	01	a	97	65	1	2	1	1	2	4																
66	STX	02	b	98	66	1	2	1	4	2	1																
67	ETX	03	c	99	67	1	4	1	1	2	2																
68	EOT	04	d	100	68	1	4	1	2	2	1																
69	ENQ	05	e	101	69	1	1	2	2	1	4																
70	ACK	06	f	102	70	1	1	2	4	1	2																
71	BEL	07	g	103	71	1	2	2	1	1	4																
72	BS	08	h	104	72	1	2	2	4	1	1																
73	HT	09	i	105	73	1	4	2	1	1	2																
74	LF	10	j	106	74	1	4	2	2	1	1																
75	VT	11	k	107	75	2	4	1	2	1	1																
76	FF	12	l	108	76	2	2	1	1	1	4																
77	CR	13	m	109	77	4	1	3	1	1	1																
78	SO	14	n	110	78	2	4	1	1	1	2																
79	SI	15	o	111	79	1	3	4	1	1	1																
80	DLE	16	p	112	80	1	1	1	2	4	2																
81	DC1	17	q	113	81	1	2	1	1	4	2																
82	DC2	18	r	114	82	1	2	1	2	4	1																
83	DC3	19	s	115	83	1	1	4	2	1	2																
84	DC4	20	t	116	84	1	2	4	1	1	2																
85	NAK	21	u	117	85	1	2	4	2	1	1																
86	SYN	22	v	118	86	4	1	1	2	1	2																
87	ETB	23	w	119	87	4	2	1	1	1	2																
88	CAN	24	x	120	88	4	2	1	2	1	1																
89	EM	25	y	121	89	2	1	2	1	4	1																
90	SUB	26	z	122	90	2	1	4	1	2	1																
91	ESC	27	{	123	91	4	1	2	1	2	1																
92	FS	28		124	92	1	1	1	1	4	3																
93	GS	29	}	125	93	1	1	1	3	4	1																
94	RS	30	~	126	94	1	3	1	1	4	1																
95	US	31	DEL	127	95	1	1	4	1	1	3																
96	FNC3		FNC3		96	1	1	4	3	1	1																
97	FNC2		FNC2		97	4	1	1	1	1	3																
98	SHIFT		SHIFT		98	4	1	1	3	1	1																
99	CODE C		CODE C		99	1	1	3	1	4	1																

Symbol character value	Code set A	ASCII value for code set A	Code set B	ASCII value for code set B	Code set C	Element widths (Modules)						Element pattern																										
						B	S	B	S	B	S	1	2	3	4	5	6	7	8	9	10	11																
100	CODE B		FNC4		CODE B	1	1	4	1	3	1																											
101	FNC4		CODE A		CODE A	3	1	1	1	4	1																											
102	FNC1		FNC1		FNC1	4	1	1	1	3	1																											
103			Start A			2	1	1	4	1	2																											
104			Start B			2	1	1	2	1	4																											
105			Start C			2	1	1	2	3	2																											

Symbol character values	Code set A	Code set B	Code set C	Element widths (Modules)						Element pattern																													
				B	S	B	S	B	S	B	1	2	3	4	5	6	7	8	9	10	11	12	13																
	Stop																																						
				2	3	3	1	1	1	2																													

Note: The stop character comprises 13 modules in four bars (dark bars) and three spaces (light bars). Every other character comprises 11 modules, starts with a bar (dark bar), ends with a space (light bar) and comprises six elements, each of which varies from one to four modules in width. The numeric values in the B and S columns represent the number of modules in each bar (dark bar) or space (light bar) element respectively in the symbol characters.

5.4.3.3 Code sets

This section contains information on code sets.

5.4.3.3.1 Code set A

Code set A includes all of the standard upper case alphanumeric characters and punctuation characters together with the symbology elements (e.g., characters with ASCII values from 00 to 95) and seven special characters.

5.4.3.3.2 Code set B

Code set B includes all of the standard upper case alphanumeric characters and punctuation characters together with the lowercase alphabetic characters (e.g., ASCII characters 32 to 127 inclusive) and seven special characters.

5.4.3.3.3 Code set C

Code set C includes the set of 100 digit pairs from 00 to 99 inclusive, as well as three special characters. This allows numeric data to be encoded as two data digits per symbol character.

5.4.3.4 Special characters

The last seven characters of code sets A and B (character values 96 to 102) and the last three characters of code set C (character values 100 to 102) are special non-data characters that, though they have particular significance to the barcode reader, have no ASCII character equivalents.

5.4.3.4.1 Code set and shift characters

Code set and shift characters SHALL be used to change from one code set to another within a symbol. The decoder SHALL NOT transmit them.

- Code set characters: Code A, B, or C characters change the symbol code set from the code set previously defined to the new code set, which is defined by the code character. This change applies to all characters following the code set character until either the end of the symbol, another code set character, or the shift character is encountered.
- Shift character: The shift character changes the code set from A to B or B to A for the single character following the shift character. Characters following the affected character SHALL revert to the code set A or B defined prior to the shift character.

5.4.3.4.2 Function characters

Function characters (FNC) provide special operations and application instructions to the barcode reading device.

- The Function 1 Symbol Character (FNC1) SHALL be subject to the special considerations defined in section [5.4.3.6](#). An FNC1 in the first position following the start character of a Code-128 symbol is at all times a reserved use, which identifies the GS1 system.
- The Function 2 Character (FNC2) (Message Append) is not used in the GS1 system. It instructs the barcode reader to temporarily store the data from the symbol containing the FNC2 and transmit it as a prefix to the data of the next symbol. This may be used to concatenate several symbols before transmission. This character may occur anywhere in the symbol. Where the sequence of data is significant, provision should be made to ensure reading of the symbols in the correct sequence.
- The Function 3 Character (FNC3) (Initialise) instructs the barcode reader to interpret the data from the symbol containing the FNC3 as instructions for initialisation or reprogramming of the barcode reader. The data from the symbol SHALL NOT be transmitted by the barcode reader. This character may occur anywhere in the symbol.
- The Function 4 Character (FNC4) is not used in the GS1 system. In Code 128 symbols, FNC4 is used to represent an extended ASCII character set (byte values 128 to 255) as specified in *ISO 8859-1: Information technology; 8-bit single-byte coded graphical character sets; Part 1: Latin alphabet No.1*, or otherwise in an application specification. If a single FNC4 is used, the value 128 is added to the ASCII value of the following data character in the symbol. A shift character may follow the FNC4 if it is necessary to change the code set for the following data character. Subsequent data characters revert to the standard ASCII set. If two consecutive FNC4s are used, the value 128 is added to the ASCII value of the following data characters until two further consecutive FNC4s are encountered or the end of the symbol is reached. If, during this sequence of extended ASCII encodation, a single FNC4 is encountered, it is used to revert to standard ASCII encodation for the next data character only. Shift and code set characters SHALL have their normal effect during such a sequence. The default reference character set for extended ASCII values 128 to 255 is the corresponding half of *ISO 8859-1, Latin alphabet 1*, but application specifications may define or reference alternative sets corresponding to byte values 128 to 255.

5.4.3.5 Start and stop characters

- Start characters A, B and C define the corresponding code set to be used initially in the symbol.
- The stop character is common to all code sets.
- The decoder SHALL NOT transmit start and stop characters.

5.4.3.6 Symbol check character

The symbol check character SHALL be included as the last symbol character before the stop character. Section [5.4.7.5.1](#) defines the algorithm for its calculation. The symbol check character SHALL NOT be represented in the human readable interpretation nor SHALL it be transmitted by the decoder.

5.4.3.7 GS1-128 symbology start pattern

The GS1-128 symbology has special double character start patterns consisting of start (A, B, or C) and FNC1. These special start characters differentiate GS1-128 barcodes from the more generalised Code 128 symbols.

In other words, a Code 128 symbol, which begins with one of the GS1-128 symbology double character start patterns, is always a GS1-128 barcode; a Code 128 symbol, which does not begin with this start pattern, is never a GS1-128 barcode.

A Function 1 Symbol Character (FNC1) may be the symbol check character (in less than 1 percent of cases). It is also used as a separator character, when appropriate, if element strings are concatenated into a single barcode.

- Start A begins the GS1-128 symbol data encodation according to character set A.
- Start B begins the GS1-128 symbol data encodation according to character set B.

Start C begins the GS1-128 symbol data encodation according to character set C. Start character C SHOULD always be used when the data inclusive of the AI begins with four or more numeric characters.

5.4.3.8 Relationship of symbol character value to ASCII value (informative)

In order to convert symbol character value (S) to ASCII decimal value or vice versa, the following relationships are applicable for code set A and code set B.

- Code set A
 - If:** $S \leq 63$
 - Then:** ASCII value = $S + 32$
 - If:** $64 \leq S \leq 95$
 - Then:** ASCII value = $S - 64$
- Code set B
 - If:** $S \leq 95$,
 - Then:** ASCII value = $S + 32$

The resulting values are shown in figure [5.4.3.2-1](#).

- ✓ **Note:** As described in section [5.4.3](#), the Function 4 Character (FNC4) is not used in the GS1 system. However, the presence of FNC4 in Code 128 symbols has the effect of adding 128 to the ASCII value of the subsequent data character or characters derived from the rules given above.

5.4.4 Dimensional requirements

GS1-128 barcodes SHALL conform to the dimensions in the subsections that follow.

5.4.4.1 Minimum width of a module (X-dimension)

The minimum X-dimension is defined by the application specification and requirements (see section [5.12](#)), while considering the equipment available for symbol production and scanning. Application specifications stipulate a target and minimum and maximum width of the X-dimension, see the symbol specifications in section [5.12.3](#)

The X-dimension SHALL be constant throughout a given symbol.

5.4.4.2 Quiet Zone

The minimum width of the Quiet Zone to the left and right of the GS1-128 barcode is 10x.

5.4.4.3 Maximum symbol length

The maximum length of any GS1-128 barcode must be within the following limits:

- The length, including Quiet Zones, cannot exceed 165.10 millimetres (6.500 inches).
- The number of encoded data characters SHALL NOT exceed 48. Data characters include GS1 Application Identifier(s) and the Function 1 Symbol Character (FNC1) when used as a separator character. The start, leading Function 1, symbol check and stop characters are not data characters. The total number of transmitted data characters following the symbology identifier SHALL NOT exceed 48.

5.4.5 Reference decode algorithm

Barcode reading systems are designed to read imperfect symbols to the extent that practical algorithms permit. This section describes the reference decode algorithm used in the computation of the decodability value described in *ISO/IEC 15416*.

The algorithm contains the following steps to decode each character:

- Calculate eight width measurements p , e_1 , e_2 , e_3 , e_4 , b_1 , b_2 and b_3 (see figure below).

Figure 5.4.5-1. Decode measurements

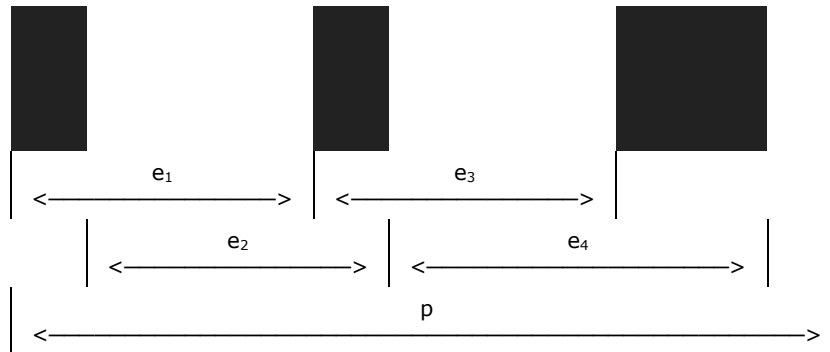

- Convert measurements e_1 , e_2 , e_3 and e_4 to normalised values E_1 , E_2 , E_3 and E_4 , which will represent the integral module width (E_i) of these measurements. The following method is used for the i -th value:
 - If $1,5p/11 \leq e_i < 2,5p/11$, then $E_i = 2$
 - If $2,5p/11 \leq e_i < 3,5p/11$, then $E_i = 3$
 - If $3,5p/11 \leq e_i < 4,5p/11$, then $E_i = 4$
 - If $4,5p/11 \leq e_i < 5,5p/11$, then $E_i = 5$
 - If $5,5p/11 \leq e_i < 6,5p/11$, then $E_i = 6$
 - If $6,5p/11 \leq e_i < 7,5p/11$, then $E_i = 7$
- Otherwise the character is in error.
- Look up the character in the decode table using the four values E_1 , E_2 , E_3 and E_4 as the key (see figure below).
 - Retrieve the self-checking symbol character value V , which is stored in the table with the character. The value V is equal to the sum of the modules for the bars (dark bars) as defined for that character.

- Verify that:

$$(V-1, 75)p / 11 < (b_1 + b_2 + b_3) < (V + 1, 75)p / 11$$

Otherwise the character is in error.

The calculation indirectly uses character parity to detect all decode errors caused by single non-systematic one-module edge errors.

Using these five steps, decode the first character. If it is a start character, continue decoding the symbol in the normal forward direction. If it is not a start character but decodes as a stop character, attempt to decode all subsequent characters in the reverse direction.

After all characters have been decoded, make sure there is a valid start character, a valid stop character and that the symbol check character is correct.

Translate the symbol characters into the appropriate data characters from code set A, B, or C according to the start character, code characters and shift characters used in the symbol.

In addition, perform other secondary checks on Quiet Zones, beam acceleration, absolute timing and dimensions that are appropriate considering the specific reading device and intended application environment.



Note: In this algorithm the symbol is decoded using edge to similar edge measurements (e) and an additional measurement of the sum of the three bar (dark bar) widths.

Figure 5.4.5-2. Edge differences for decoding code 128 symbols

Char. value	E1	E2	E3	E4	V	Char. value	E1	E2	E3	E4	V
00	3	3	4	4	6	54	4	2	2	3	6
01	4	4	3	3	6	55	4	2	4	5	6
02	4	4	4	4	6	56	6	4	2	3	6
03	3	3	3	4	4	57	4	3	3	2	6
04	3	3	4	5	4	58	4	3	5	4	6
05	4	4	3	4	4	59	6	5	3	2	6
06	3	4	4	3	4	60	4	5	5	2	8
07	3	4	5	4	4	61	4	3	5	5	4
08	4	5	4	3	4	62	7	4	2	2	6
09	4	3	3	3	4	63	2	2	3	4	4
10	4	3	4	4	4	64	2	2	5	6	4
11	5	4	3	3	4	65	3	3	2	3	4
12	2	3	4	5	6	66	3	3	5	6	4
13	3	4	3	4	6	67	5	5	2	3	4
14	3	4	4	5	6	68	5	5	3	4	4
15	2	4	5	4	6	69	2	3	4	3	4
16	3	5	4	3	6	70	2	3	6	5	4
17	3	5	5	4	6	71	3	4	3	2	4
18	4	5	5	3	6	72	3	4	6	5	4
19	4	3	2	4	6	73	5	6	3	2	4
20	4	3	3	5	6	74	5	6	4	3	4
21	3	4	5	3	6	75	6	5	3	3	4
22	4	5	4	2	6	76	4	3	2	2	4
23	4	3	3	4	8	77	5	4	4	2	8
24	4	2	3	4	6	78	6	5	2	2	4
25	5	3	2	3	6	79	4	7	5	2	6
26	5	3	3	4	6	80	2	2	3	6	6
27	4	3	4	3	6	81	3	3	2	5	6
28	5	4	3	2	6	82	3	3	3	6	6
29	5	4	4	3	6	83	2	5	6	3	6
30	3	3	3	3	6	84	3	6	5	2	6
31	3	3	5	5	6	85	3	6	6	3	6
32	5	5	3	3	6	86	5	2	3	3	6
33	2	2	4	5	4	87	6	3	2	2	6
34	4	4	2	3	4	88	6	3	3	3	6
35	4	4	4	5	4	89	3	3	3	5	8
36	2	3	5	4	4	90	3	5	5	3	8
37	4	5	3	2	4	91	5	3	3	3	8
38	4	5	5	4	4	92	2	2	2	5	6
39	3	2	4	4	4	93	2	2	4	7	6
40	5	4	2	2	4	94	4	4	2	5	6

Char. value	E1	E2	E3	E4	V	Char. value	E1	E2	E3	E4	V
41	5	4	4	4	4	95	2	5	5	2	6
42	2	3	3	4	6	96	2	5	7	4	6
43	2	3	5	6	6	97	5	2	2	2	6
44	4	5	3	4	6	98	5	2	4	4	6
45	2	4	4	3	6	99	2	4	4	5	8
46	2	4	6	5	6	100	2	5	5	4	8
47	4	6	4	3	6	101	4	2	2	5	8
48	4	4	4	3	8	102	5	2	2	4	8
49	3	2	4	6	6	103	3	2	5	5	4
50	5	4	2	4	6	104	3	2	3	3	4
51	3	4	4	2	6	105	3	2	3	5	6
52	3	4	6	4	6	Stop_A	5	6	4	2	6
53	3	4	4	4	8	Stop_B	3	2	2	4	6

- ✔ **Note:** Stop_A values are for decoding in a forward direction. Stop_B values apply to the first six elements of the stop character starting at the rightmost side when scanned in a reverse direction.

5.4.6 Symbol quality

5.4.6.1 General

ISO/IEC 15416 defines a standardised methodology for measuring and grading barcodes. Code 128 symbols SHALL be evaluated according to that standard. The reference decode algorithm defined in section [5.3.2.3](#) SHALL be used for the assessment of the decode and decodability parameters under *ISO/IEC 15416*.

- ✔ **Note:** For GS1-128 barcode minimum quality levels, refer to section [5.4.7](#).

5.4.6.2 Decodability

Decodability is a measure of how closely the decode algorithm measurement values approach those in a theoretically perfect symbol. Thus, decodability is a parameter that measures how closely the Scan Reflectance Profile is to approaching decode failure for a given printed symbol.

For the calculation of the decodability value *V*, the following provisions apply, which supplement those described in *ISO/IEC 15416* for edge to similar edge decodable symbologies:

Substitute V1 for VC in the formula $VC = K / (S / 2n)$

Where: **K** = the smallest difference between a measurement and a reference threshold.

N = 11 (number of modules in a symbol character).

S = total width of the character.

Calculate V2

$$V2 = \frac{1,75 - \left(\text{ABS} \left(\left(Wb \times \frac{11}{S} \right) - M \right) \right)}{1,75}$$

Where: **M** = number of dark modules in the character.

S = total width of the character.

Wb = sum of the bar (dark bar) widths in the character.

ABS = mathematical term for taking the absolute of the calculation that follows.

VC is the lesser of V1 and V2.

The stop character includes an additional terminating bar (dark bar). For the purpose of measuring decodability, the stop character SHOULD be checked twice: first using the six leftmost elements and then using the six rightmost elements from right to left. Both sets of six elements are equivalent in width to a standard character.

5.4.6.3 Quiet Zone measurement

The Quiet Zones to the right and left of the GS1-128 barcode are compulsory. Both Quiet Zones have a minimum width of 10x.

ISO/IEC 15416 allows for additional pass/fail criteria to be stipulated by a symbology specification. In the case of a GS1-128 barcode, a minimum Quiet Zone of 10Z is specified. Both left and right Quiet Zones on each Scan Reflectance Profile (SRP) under *ISO/IEC 15416* SHALL be measured and graded as follows:

Quiet Zone \geq 10Z: Grade 4 (A).

Quiet Zone $<$ 10Z: Grade 0 (F).

Where Z = the average measured width of the narrow bars (dark bars) and spaces (light bars) (one module) in the symbol.

5.4.6.4 Transmitted data

Transmitted data from a decoded GS1-128 barcode SHALL comprise the byte values of the data characters. It is prefixed by the symbology identifier **JC1**, if used. The start and stop characters, function characters, code set and shift characters and symbol check character SHALL NOT be included in the transmitted data.



Note: For GS1-128 symbology implementation, see section [5.4.7](#).

5.4.7 GS1-128 symbology application parameters

5.4.7.1 Symbol height

The symbol height of a GS1-128 symbol depends on the specific application requirements. Please see section [5.12.3](#) for minimum symbol height specifications.

5.4.7.2 Symbol length

The dimensions of the GS1-128 barcode depend on the number of characters encoded:

1 start character x 11 modules = 11

Function 1 Symbol Character (FNC1) x 11 modules = 11

1 symbol check character x 11 modules = 11

1 stop character x 13 modules = 13

N symbol characters x 11 modules = 11N

(11N + 46) modules

Where N is the number of symbol characters, any auxiliary characters (shift and code characters) embedded in the data are included.

A module is equal to the X-dimension of the symbol.

Character set C allows two digits to be encoded in one symbol character. Thus, numeric data can be encoded with twice the density of other data when using character set C.

In addition, Quiet Zones to the right and left of the barcode are compulsory and both have widths of 10 modules.

Thus total symbol length, including Quiet Zones, is: **(11N + 66) modules = (11N + 66) X**

Please see section 5.4.4.3 for maximum symbol length specifications.

5.4.7.3 Human readable interpretation

For human readable interpretation rules see section [4.14](#). For HRI rules specific to regulated healthcare retail consumer trade items, see section [4.14.1](#).

5.4.7.4 Transmitted data (FNC1)

The following GS1-128 symbology implementation specifications are in accordance with *ISO/IEC 15417 Appendix 2* for transmitted data:

- The Function 1 Symbol Character (FNC1) may validly occur as the symbol check character.
- FNC1 in the third or subsequent character position is transmitted as the control character <GS> (ASCII value 29 (decimal), 1D (hexadecimal)).
- For symbols using FNC1 in the first data position scanners SHOULD have symbology identifiers enabled.

When FNC1 is used in the first position, it SHALL NOT be represented in the transmitted message, although its presence is indicated by the use of modifier value 1 in the symbology identifier.

5.4.7.5 Additional features of GS1-128 (normative)

5.4.7.5.1 Symbol check character

The GS1-128 symbol check character SHALL be calculated according to the following rules.

1. Retrieve the symbol character value from figure [5.4.3.2-1](#).
2. Each symbol character position is given a weight. The start character is weighted 1. Then, beginning on the left with the first symbol character following the start character, the weights are 1, 2, 3 and 4 to...n for all subsequent symbol characters up to, but not including, the symbol check character itself; n denotes the number of symbol characters representing data or special information in the symbol, exclusive of the start and stop characters and symbol check character.

 **Note:** Both the start character and the first symbol character following the start character (the Function 1 Symbol Character (FNC1) for all GS1-128 barcodes) are weighted by one.

3. Each symbol character value is multiplied by its weight.
4. The products of the calculations in step 3 are totalled.
5. The sum of the products is divided by 103.
6. The remainder derived from the calculation in step 5 is the symbol character value of the symbol check character.

Figure [5.4.7.5.1-1](#) shows how to calculate the symbol check character value for the batch number 2503X using the GS1-128 barcode.

Figure 5.4.7.5.1-1. Symbol check character value calculation example
 Start C FNC1 10(*) 25 03 Code B X [symbol check character] Stop

Characters	Start C	FNC1	10	25	03	Code B	X
Character values (Step 1)	105	102	10	25	3	100	56
Weights (Step 2)	1	1	2	3	4	5	6
Products (Step 3)	105	102	20	75	12	500	336
Sum of products (Step 4)		1150					
Divide by 103 (Step 5)		1150 / 103 = 11					
Remainder = symbol check character value		17					

(*) GS1 Application Identifier (10) is defined as batch or lot number.

The symbol check character SHALL be positioned immediately after the final data character and before the stop character.

 **Note:** The symbol check character SHALL NOT be shown in the human readable interpretation.

5.4.7.6 Recommended use of symbol characters to minimise GS1-128 symbol length (informative)

The same data may be represented in different GS1-128 barcodes through the use of different combinations of Start A, Start B, Start C, FNC1, Code A, Code B, Code C and Shift characters.

The following steps may be implemented in printer control software to minimise the number of symbol characters needed to represent a given data string (and, therefore, reduce the overall symbol length).

1. Begin with characters Start C and FNC1.
2. If the data begins with an odd number of digits, insert a Code B character before the last digit.
3. If in a code set B there are four or more consecutive digits and:
 - a. If there is an even number of digits, insert a Code C character before the first digit to change to code set C.
 - b. If there is an uneven number of digits, insert a Code C character immediately after the first digit to change to code set C.
4. When in code set C and a non-numeric character occurs in the data, insert a Code B character before that character.

 **Note:** Code set A may still be used to create GS1-128 barcodes but it encodes fewer data character options than code set B. Code set C encodes a pair of digits as one symbol character so it is more space efficient when encoding four or more consecutive digits. There is no need to use code set A to encode <GS> as a separator character because FNC1 may be used for this purpose.

5.4.7.7 Guidelines for the use of Code 128 (informative)

5.4.7.7.1 Autodiscrimination compatibility

Code 128 symbols may be read by suitably programmed barcode readers that have been designed to autodiscriminate these symbols from other symbologies. Code 128 symbology is fully distinguishable from and compatible with the following linear symbologies:

- ITF (Interleaved 2 of 5)
- Codabar

- Code 39
- Code 93
- EAN/UPC
- Telepen
- GS1 DataBar

5.5 Linear barcodes - GS1 DataBar

5.5.1 Introduction

GS1 DataBar is a family of linear symbologies used within the GS1 system. There are three types of GS1 DataBar symbols, two of which have a number of variations optimised for different application requirements.

The first type has four variations (GS1 DataBar Omnidirectional, GS1 DataBar Truncated, GS1 DataBar Stacked and GS1 DataBar Stacked Omnidirectional) and encodes AI (01) in a linear symbol. The second type comprises only one variation namely GS1 DataBar Limited which encodes AI (01) in a linear symbol for use on small items that will not be scanned in an omnidirectional scanning environment. The third type has two variations; a single row variation (GS1 DataBar Expanded) and a multi-row stacked variation (GS1 DataBar Expanded Stacked). Both variations encode GS1 system primary item identification plus supplementary AI element strings, such as weight and "best before" date, in a linear symbol that can be scanned omnidirectionally by suitably programmed slot scanners.

GS1 DataBar Stacked is a variation of the first type of GS1 DataBar symbology that is stacked in two rows and used when the normal symbol would be too wide for the application. It comes in two variations: a truncated variation used for small item marking applications and a taller variation that is designed to be read by omnidirectional scanners. GS1 DataBar Expanded can also be printed in multiple rows as a stacked symbol.

Any member of the GS1 DataBar family can be printed as a stand-alone linear symbol or as a component of a composite symbol with an accompanying two-dimensional (2D) Composite Component printed above the GS1 DataBar linear component.

The GS1 DataBar family is fully described in *ISO/IEC 24724*.

5.5.1.1 Symbology characteristics

The GS1 DataBar family consists of the following variations:

- GS1 DataBar Omnidirectional
- GS1 DataBar Truncated
- GS1 DataBar Stacked
- GS1 DataBar Stacked Omnidirectional
- GS1 DataBar Limited
- GS1 DataBar Expanded
- GS1 DataBar Expanded Stacked

The characteristics of the GS1 DataBar family are:

- Encodable character set:
 - GS1 DataBar Omnidirectional, GS1 DataBar Truncated, GS1 DataBar Stacked, GS1 DataBar Stacked Omnidirectional and GS1 DataBar Limited: Digits 0 through 9 (with the restriction of GS1 DataBar Limited to 0 or 1 in the first digit) in accordance with *ISO/IEC 646*. Refer to figure [7.11-1](#) for more details.
 - GS1 DataBar Expanded variations: The GS1 system requires that only the subset of *ISO/IEC 646 International Reference Version* defined in these *GS1 General Specifications* be used for

GS1 Application Identifier (AI) element strings. Refer to figure [7.11-1](#) for the allowed encodable character set.

- Symbol character structure: Different (n,k) symbol characters are used for each member of the family, where each symbol character is n modules in width and is composed of k bars and k spaces.
- Code type: Continuous, linear barcode symbology.
- Maximum numeric data capacity (including implied GS1 Application Identifiers (AIs) where appropriate, but not including any encoded FNC1 characters):
 - All GS1 DataBar symbols except the expanded versions: AI (01) plus a 14-digit numeric item identification.
 - GS1 DataBar Expanded variations: 74 numeric or 41 alphabetic characters.
- Error detection:
 - GS1 DataBar Omnidirectional, GS1 DataBar Truncated, GS1 DataBar Stacked and GS1 DataBar Stacked Omnidirectional: mod 79 checksum.
 - GS1 DataBar Limited: mod 89 checksum.
 - GS1 DataBar Expanded variations: mod 211 checksum.
- Character self-checking.
- Bidirectionally decodable.
- Quiet Zones: None required.

5.5.1.2 Additional features

Additional GS1 DataBar features include:

- Data compaction: Each member of the GS1 DataBar family has data compaction methods optimised for the data strings that it will encode. GS1 DataBar Expanded variations are also optimised for specific sequences of GS1 Application Identifiers (AIs) that are commonly used.
- Component linkage: All GS1 DataBar symbols include a linkage flag. If the linkage flag is 0, then the GS1 DataBar symbol stands alone. If the linkage flag is 1, then a 2D Composite Component and its separator pattern are printed above the GS1 DataBar symbol with the separator pattern aligned and contiguous to the GS1 DataBar symbol.
- Edge to similar edge decoding: All GS1 DataBar family symbol characters, finder patterns and symbol check characters can be decoded using edge-to-edge measurements.
- Large symbol characters: Unlike EAN/UPC symbols, a GS1 DataBar symbol's symbol characters do not directly correspond to the encoded data character. The symbol's symbol characters encode thousands of possible combinations to increase the encoding efficiency. They are then combined mathematically to form the encoded data string.
- GS1-128 symbol emulation: Readers set to the GS1-128 symbol emulation mode transmit the data encoded within a GS1 DataBar symbol as if the data were encoded in one or more GS1-128 symbols.

5.5.2 Symbol structure

5.5.2.1 The first group of GS1 DataBar symbols

The first group of GS1 DataBar symbols encodes the element string AI (01). It has four variations: GS1 DataBar Omnidirectional, GS1 DataBar Truncated, GS1 DataBar Stacked and GS1 DataBar Stacked Omnidirectional. All four variations encode data in an identical manner.

Figure [5.5.2.1-1](#) shows the structure of this group of GS1 DataBar symbols. These four different symbols, as explained below, contain four symbol characters and two finder patterns. The symbols are capable of being scanned in four separate segments, each consisting of a symbol character and

an adjacent finder pattern. The two finder patterns together encode a modulo 79 check value for data security.

Figure 5.5.2.1-1. First group of GS1 DataBar symbols structure

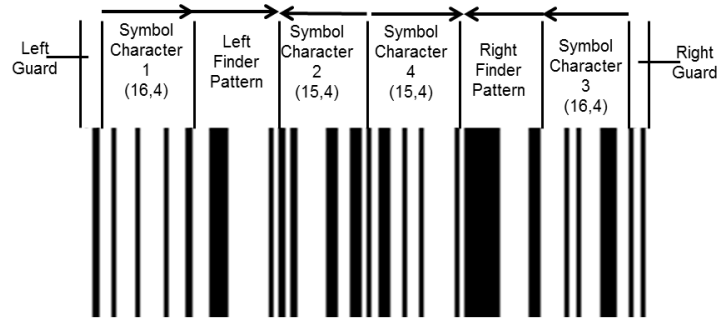

The left and right guard bar patterns consist of a narrow space and narrow bar. These variations do not require a Quiet Zone.

5.5.2.1.1 GS1 DataBar Omnidirectional

The GS1 DataBar Omnidirectional barcode is designed to be read by an omnidirectional scanner, such as a retail slot scanner. Its dimensions are 96X wide, starting with a 1X space and ending with a 1X bar, by 33X high (where X is the width of a module). 33X is the minimum height of the symbol but the actual height of the symbol used depends on the specific application requirements. For example, a GS1 DataBar Omnidirectional symbol with an X-dimension of 0.254 millimetre (0.0100 inch) would be 24.38 millimetre (0.960 inch) wide and 8.38 millimetre (0.330 inch) high.

Figure 5.5.2.1.1-1. GS1 DataBar Omnidirectional barcode



5.5.2.1.2 GS1 DataBar Truncated

The GS1 DataBar Truncated barcode is a reduced height variation of the GS1 DataBar Omnidirectional barcode that is designed for small items that will not need to be read by omnidirectional scanners. Its dimensions are 96X wide by 13X high (where X is the width of a module). For example, a GS1 DataBar Truncated symbol with an X-dimension of 0.254 millimetre (0.0100 inch) would be 24.38 millimetres (0.960 inch) wide by 3.30 millimetres (0.130 inch) high.

Figure 5.5.2.1.2-1. GS1 DataBar Truncated barcode



5.5.2.1.3 GS1 DataBar Stacked

The GS1 DataBar Stacked barcode is a reduced height two-row variation of the GS1 DataBar Omnidirectional barcode that is designed for small items that will not need to be read by omnidirectional scanners. Its dimensions are 50X wide by 13X high (where X is the width of a module). For example, a GS1 DataBar Stacked symbol with an X-dimension of 0.254 millimetre (0.0100 inch) would be 12.70 millimetres (0.500 inch) wide by 3.30 millimetres (0.130 inch) high. Its structure includes a 1X high separator pattern between the two rows.

Figure 5.5.2.1.3-1. GS1 DataBar Stacked barcode



5.5.2.1.4 GS1 DataBar Stacked Omnidirectional

The GS1 DataBar Stacked Omnidirectional barcode is a full height, two-row variation of the GS1 DataBar Omnidirectional barcode that is designed to be read by an omnidirectional scanner, such as a retail slot scanner. Its dimensions are 50X wide by 69X high (where X is the width of a module). 69X is the minimum height of the symbol but the actual height of the symbol used depends on the specific application requirements. For example, a GS1 DataBar Stacked Omnidirectional symbol with an X-dimension of 0.254 millimetre (0.0100 inch) would be 12.70 millimetres (0.500 inch) wide by 17.53 millimetres (0.690 inch) high. The height of 69X includes a 3X high separator pattern between two rows of 33X each.

Figure 5.5.2.1.4-1. GS1 DataBar Stacked Omnidirectional barcode



5.5.2.2 The second group of GS1 DataBar symbols: GS1 DataBar Limited

The GS1 DataBar Limited barcode is the second group of GS1 DataBar symbols. It encodes the element string AI (01). This element string is based on the GTIN-12, GTIN-13, or GTIN-14 data structures. However, when using the GTIN-14 data structure, only the indicator value 1 is allowed. When encoding GTIN-14 data structures with an indicator value greater than 1, one of the first group of GS1 DataBar symbols must be used: see section [5.5.2.1](#).

The GS1 DataBar Limited barcode is designed for small items that will not need to be read by omnidirectional point-of-sale (POS) scanners. Its dimensions are 79X wide, starting with a 1X space and ending with a 5X space, by 10X high (where X is the width of a module). For example, a GS1 DataBar Limited barcode with an X-dimension of 0.254 millimetre (0.0100 inch) would be 20.07 millimetres (0.790 inches) wide by 2.54 millimetres (0.100 inch) high.

Figure 5.5.2.2-1. GS1 DataBar Limited barcode

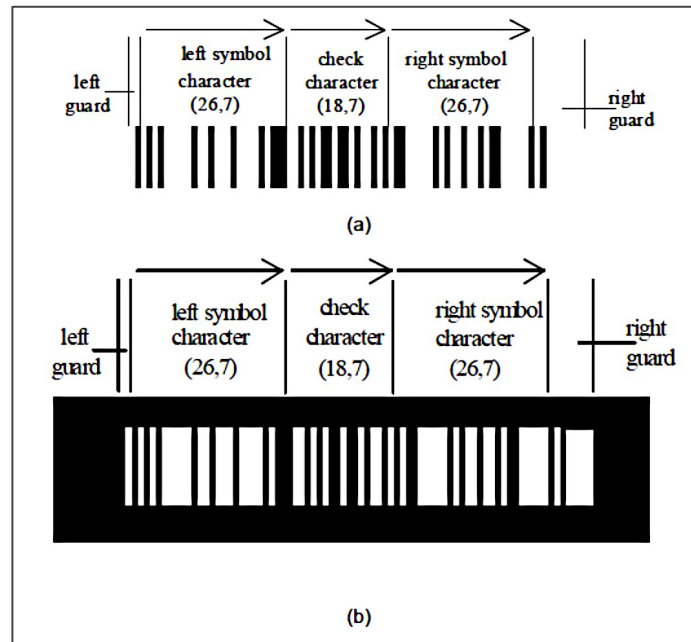

Figure [5.5.2.2-2](#) shows the structure of the GS1 DataBar Limited barcode. A GS1 DataBar Limited symbol contains two data characters and a symbol check character. The symbol check character encodes a modulo 89 check value for data security.

Figure 5.5.2.2-2. GS1 DataBar Limited barcode structure

- (a) GS1 DataBar Limited symbol representing (01)00312345678906
 (b) The same symbol on a dark background. Notice the trailing space in the right guard pattern

The total symbol contains 47 elements comprising 79 modules. The minimum height SHALL be 10X. No Quiet Zones are required, however while each light module on both ends of the Limited symbol may look like a Quiet Zone, each differs from a Quiet Zone in that the reference decode algorithm must check for these guard bar patterns in order to avoid misreading a UPC-A symbol as a GS1 DataBar Limited symbol. The leading and trailing space elements may blend into the background of the symbol if that background is the same colour as the spaces in the symbol.

5.5.2.3 The third group of GS1 DataBar symbols: GS1 DataBar Expanded variations

GS1 DataBar Expanded variations are the third group of GS1 DataBar symbols and are a variable length linear symbology capable of encoding up to 74 numeric or 41 alphabetic characters of AI element string data. The two variations, GS1 DataBar Expanded and GS1 DataBar Expanded Stacked are designed to encode primary and supplementary data on items for point-of-sale (POS) and other applications. They have the same capabilities as a GS1-128 symbol except that they are also designed to be scanned by omnidirectional slot scanners. They are designed for variable weight products, perishable products, traceable retail products and coupons.

Figure [5.5.2.3-1](#) shows the structure of a six-segment GS1 DataBar Expanded symbol. GS1 DataBar Expanded symbols contain a symbol check character, 3 to 21 symbol characters and 2 to 11 finder patterns, depending on the symbol length. GS1 DataBar Expanded is capable of being scanned in separate segments, each segment consisting of a symbol character or symbol check character and the adjacent finder pattern. The symbol check character encodes a modulo 211 check value for data security.

Figure 5.5.2.3-1. GS1 DataBar Expanded structure

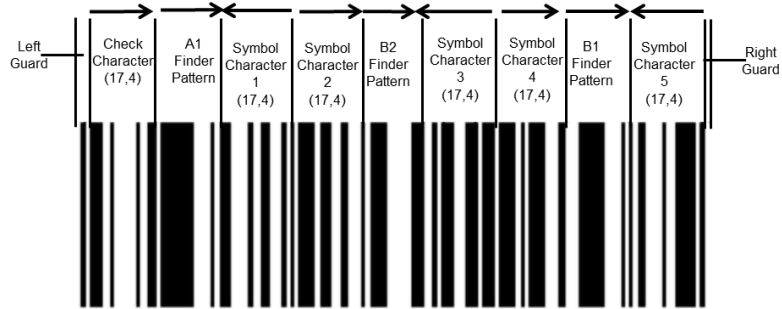

The left and right guard bar patterns consist of a narrow bar and narrow space. GS1 DataBar Expanded variations do not require a Quiet Zone.

5.5.2.3.1 GS1 DataBar Expanded

The GS1 DataBar Expanded barcode has a variable width (from 4 to 22 symbol characters, or a minimum of 102X wide and a maximum of 534X wide) and is 34X high (where X is the width of a module). The symbol starts with a 1X space and ends with either a 1X bar or space. For example, the GS1 DataBar Expanded Symbol shown in figure 5.5.2.3.1-1 with an X-dimension of 0.254 millimetre (0.0100 inch) would be 38.35 millimetres (1.51 inches) wide by 8.64 millimetres (0.340 inch) high.

Figure 5.5.2.3.1-1. GS1 DataBar Expanded barcode



(01)90614141000015(3202)000150

5.5.2.3.2 GS1 DataBar Expanded Stacked

The GS1 DataBar Expanded Stacked barcode is a multi-row stacked variation of GS1 DataBar Expanded. It can be printed in widths of 2 to 20 segments and can have from 2 to 11 rows. Its structure includes a 3X high separator pattern between rows. It is designed to be read by an omnidirectional scanner such as a retail slot scanner. The GS1 DataBar Expanded Stacked symbol shown in figure 5.5.2.3.2-1 with an X-dimension of 0.254 millimetre (0.0100 inch) would be 25.91 millimetres (1.020 inches) wide by 18.03 millimetres (0.710 inch) high.

The white space at the end of the second row of the symbol shown in the figure below is not part of the symbol and can be used for other purposes, such as text.

Figure 5.5.2.3.2-1. GS1 DataBar Expanded Stacked barcode



(01)90614141000015(3202)000150

GS1 DataBar Expanded Stacked is used when the symbol area or print mechanism is not wide enough to accommodate the full single-row GS1 DataBar Expanded symbol. It is designed for variable weight products, perishable products, traceable retail products and coupons.

5.5.2.3.3 Compressed element string sequences

While GS1 DataBar Expanded symbols can encode any sequence of GS1 Application Identifier (AI) data up to the maximum capacity of the symbol, certain sequences of AI element strings have been selected for special compression in GS1 DataBar Expanded variations. If the application requires the use of the AI element strings in one of these sequences and they are used in the predefined sequence, a smaller symbol will result.

The selected sequences are two types: fixed length, where the sequence of selected AI element strings is the only data encoded, and open-ended, where the sequence occurs at the start of the symbol's data and other AI element strings may be added following the sequence. If the data to be encoded in a GS1 DataBar Expanded symbol starts with a sequence defined as fixed length but is followed by additional AI element strings, all the data will be encoded normally without special compression.

Fixed-length sequences

This section contains information on fixed-length sequences.

AI (01) and weight with limited range

This sequence consists of the two GS1 Application Identifier (AI) element strings AI (01), followed by AI (3103), AI (3202), or AI (3203) for weight. The AI (01) element string must start with an indicator value of 9 for variable measure. Using AI (3103) (weight in grams), the special compression can only be applied up to a maximum weight of 32.767 kilograms. Using AI (3202) (weight in 0.01 pounds) the special compression can only be applied up to a maximum weight of 99.99 pounds. Using AI (3203) (weight in 0.001 pounds) the special compression can only be applied up to a maximum weight of 22.767 pounds. If the weight is in excess of these values, the sequence defined here still enables special compression to be performed.

AI (01): Weight and optional date

This sequence consists of the two or three GS1 Application Identifier (AI) element strings AI (01), AI (310n), or (320n) for weight (n ranging from 0 to 9) and optionally AI (11), AI (13), AI (15), or AI (17) for date. The AI (01) element string must start with an indicator value of 9 for variable measure. If the date is not needed, this sequence still gives additional compression when the weight is outside the ranges required by the AI (01) and weight with limited range sequence above.

Open-ended sequences

This section contains information on open-ended sequences.

AI (01) and price

This sequence consists of the two GS1 Application Identifier (AI) element strings, AI (01), followed by AI (392x) for price or AI (393x) for price with ISO currency code (where x is in the range of 0 to 3). The AI (01) element string must start with an indicator value of 9 for variable measure. For example, this sequence is used for an AI (01) element string, price and weight, because the fixed-length sequence AI (01) and weight does not give additional compression if the AI element string for price is added to the end since the length of the sequence is fixed.

AI (01)

Any sequence that starts with GS1 Application Identifier (AI) (01) will have special compression applied to the AI (01). So when the data includes AI (01), it SHALL be the first element string encoded.

5.5.2.3.4 Maximum width and height of GS1 DataBar Expanded versions (informative)

Advice for maximum symbol size to optimise scanner performance

Maximum symbol width (flat surface)

For GS1 DataBar Expanded and GS1 DataBar Expanded Stacked symbols scanned with an omnidirectional slot scanner, the following maximum symbol length is recommended: 158.75 mm (6.250 inch).

For GS1 DataBar Expanded and GS1 DataBar Expanded Stacked symbols scanned with a presentation scanner, the following maximum symbol length is recommended: 158.75 mm (6.250 inch).

For GS1 DataBar Expanded and GS1 DataBar Expanded Stacked symbols scanned with a hand-held scanner, the following maximum symbol length is recommended as;

- Hand-held Linear (Laser) Scanner: 158.75 mm (6.250 inch).
- Hand-held Linear (CCD type) Scanner: 101.60 mm (4.000 inch).
- Hand-held Imager (2D) Scanner: 158.75 mm (6.250 inch).

GS1 DataBar Expanded - Symbol Length vs. Symbol Characters

Figure 5.5.2.3.4-1. GS1 DataBar symbol length specification (flat surface) Table 1

X [inch]	0.0080		0.010		0.0130		0.0260		0.0390	
X [mm]		0.203		0.254		0.330		0.660		0.991
Characters										
4	0.816	20.73	1.020	25.91	1.326	33.68	2.652	67.36	3.978	101.04
5	1.072	27.23	1.340	34.04	1.742	44.25	3.484	88.49	5.226	132.74
6	1.208	30.68	1.510	38.35	1.963	49.86	3.926	99.72	5.889	149.58
7	1.464	37.19	1.830	46.48	2.379	60.43	4.758	120.85	7.137	181.28
8	1.600	40.64	2.000	50.80	2.600	66.04	5.200	132.08	7.800	198.12
9	1.856	47.14	2.320	58.93	3.016	76.61	6.032	153.21	9.048	229.82
10	1.992	50.60	2.490	63.25	3.237	82.22	6.474	164.44	9.711	246.66
11	2.248	57.10	2.810	71.37	3.653	92.79	7.306	185.57	10.959	278.36
12	2.384	60.55	2.980	75.69	3.874	98.40	7.748	196.80	11.622	295.20
13	2.640	67.06	3.300	83.82	4.290	108.97	8.580	217.93	12.870	326.90
14	2.776	70.51	3.470	88.14	4.511	114.58	9.022	229.16	13.533	343.74
15	3.032	77.01	3.790	96.27	4.927	125.15	9.854	250.29	14.781	375.44
16	3.168	80.47	3.960	100.58	5.148	130.76	10.296	261.52	15.444	392.28
17	3.424	86.97	4.280	108.71	5.564	141.33	11.128	282.65	16.692	423.98
18	3.560	90.42	4.450	113.03	5.785	146.94	11.570	293.88	17.355	440.82
19	3.816	96.93	4.770	121.16	6.201	157.51	12.402	315.01	18.603	472.52
20	3.952	100.38	4.940	125.48	6.422	163.12	12.844	326.24	19.266	489.36
21	4.208	106.88	5.260	133.60	6.838	173.69	13.676	347.37	20.514	521.06
22	4.344	110.34	5.430	137.92	7.059	179.30	14.118	358.60	21.177	537.90

Best Performance
Not Recommended

Maximum symbol width (curved surface)

For GS1 DataBar Expanded Variation symbols with a maximum subtended angle of 60° (see [6.2.3.2-2](#) Relationship between symbol and curvature), Table 2 provides the length of a GS1 DataBar Expanded Variation symbol as a function of the X-dimension chosen. Tests show that GS1 DataBar

Expanded Variations have decreased performance at the maximum angle and it is recommended that, when possible, these symbols be made such that a smaller angle is subtended.

Figure 5.5.2.3.4-2. GS1 DataBar symbol length specification (curved surface) Table 2

Diameter (inch)	0.25	0.50	0.75	1.00	1.25	1.50	1.75	2.00	2.50	3.00
Lmax (inch)	0.131	0.262	0.393	0.524	0.654	0.785	0.916	1.047	1.309	1.571
Diameter (mm)	6.35	12.70	19.05	25.40	31.75	38.10	44.45	50.80	63.50	76.20
Lmax (mm)	3.32	6.65	9.97	13.30	16.62	19.95	23.27	26.60	33.25	39.90
Diameter (inch)	3.50	4.00	4.50	5.00	5.50	6.00	6.50	7.00	7.50	8.00
Lmax (inch)	1.833	2.094	2.356	2.618	2.880	3.142	3.456	3.665	3.927	4.189
Diameter (mm)	88.90	101.60	114.30	127.00	139.70	152.40	167.64	177.80	190.50	203.20
Lmax (mm)	46.55	53.20	59.85	66.50	73.15	79.80	87.78	93.10	99.75	106.40
Diameter (inch)	8.50	9.00	9.50	10.00	20.00	30.00	40.00	50.00	60.00	
Lmax (inch)	4.451	4.712	4.974	5.236	10.472	15.708	20.944	26.180	31.42	
Diameter (mm)	215.90	228.60	241.30	254.00	508.00	762.00	1016.00	1270.00	1524.00	
Lmax (mm)	113.05	119.69	126.34	132.99	265.99	398.98	531.98	664.97	797.96	
Diameter (inch)	0.25	0.50	0.75	1.00	1.25	1.50	1.75	2.00	2.50	3.00
Lmax (inch)	0.131	0.262	0.393	0.524	0.654	0.785	0.916	1.047	1.309	1.571
Diameter (mm)	6.35	12.70	19.05	25.40	31.75	38.10	44.45	50.80	63.50	76.20
Lmax (mm)	3.32	6.65	9.97	13.30	16.62	19.95	23.27	26.60	33.25	39.90
Diameter (inch)	3.50	4.00	4.50	5.00	5.50	6.00	6.50	7.00	7.50	8.00
Lmax (inch)	1.833	2.094	2.356	2.618	2.880	3.142	3.456	3.665	3.927	4.189
Diameter (mm)	88.90	101.60	114.30	127.00	139.70	152.40	167.64	177.80	190.50	203.20
Lmax (mm)	46.55	53.20	59.85	66.50	73.15	79.80	87.78	93.10	99.75	106.40
Diameter (inch)	8.50	9.00	9.50	10.00	20.00	30.00	40.00	50.00	60.00	
Lmax (inch)	4.451	4.712	4.974	5.236	10.472	15.708	20.944	26.180	31.42	
Diameter (mm)	215.90	228.60	241.30	254.00	508.00	762.00	1016.00	1270.00	1524.00	
Lmax (mm)	113.05	119.69	126.34	132.99	265.99	398.98	531.98	664.97	797.96	

Note: See figure [6.2.3.2-3](#) Relationship between diameter and the X-dimension.

Maximum height GS1 DataBar Expanded Stacked

For GS1 DataBar Expanded Stacked symbols, Table 3 provides the height of the symbol as a function of the number of rows and X-dimension chosen. Advice is provided, as a result of tests conducted, that indicate (shading of table cells) scanning performance as a function of the number of rows and X-dimension. It should be noted that the testing showed, independent of X-dimension, significant reduction in scanner performance, for symbols containing more than 7 rows.

Figure 5.5.2.3.4-3. GS1 DataBar Expanded Stacked height specification (informative) Table 3

Height of GS1 DataBar Expanded Stacked by row [metric units]										
X [mm]		0.203	0.254	0.330	0.381	0.508	0.660	0.762	0.889	0.991
Row	Height (modules)									
2	71	14.41	18.03	23.43	27.05	36.07	46.86	54.10	63.12	70.36
3	108	21.92	27.43	35.64	41.15	54.86	71.28	82.30	96.01	107.03
4	145	29.44	36.83	47.85	55.25	73.66	95.70	110.49	128.91	143.70
5	182	36.95	46.23	60.06	69.34	92.46	120.12	138.68	161.80	180.36
6	219	44.46	55.63	72.27	83.44	111.25	144.54	166.88	194.69	217.03
7	256	51.97	65.02	84.48	97.54	130.05	168.96	195.07	227.58	253.70

Height of GS1 DataBar Expanded Stacked by row [metric units]										
X [mm]		0.203	0.254	0.330	0.381	0.508	0.660	0.762	0.889	0.991
8	293	59.48	74.42	96.69	111.63	148.84	193.38	223.27	260.48	290.36
9	330	66.99	83.82	108.90	125.73	167.64	217.80	251.46	293.37	327.03
10	367	74.50	93.22	121.11	139.83	186.44	242.22	279.65	326.26	363.70
11	404	82.01	102.62	133.32	153.92	205.23	266.64	307.85	359.16	400.36

Height of GS1 DataBar Expanded Stacked by row [imperial units]										
X [inch]		0.0080	0.0100	0.0130	0.0150	0.0200	0.0260	0.0300	0.0350	0.0390
Row	Height (modules)									
2	71	0.568	0.710	0.923	1.065	1.420	1.846	2.130	2.485	2.769
3	108	0.864	1.080	1.404	1.620	2.160	2.808	3.240	3.780	4.212
4	145	1.160	1.450	1.885	2.175	2.900	3.770	4.350	5.075	5.655
5	182	1.456	1.820	2.366	2.730	3.640	4.732	5.460	6.370	7.098
6	219	1.752	2.190	2.847	3.285	4.380	5.694	6.570	7.665	8.541
7	256	2.048	2.560	3.328	3.840	5.120	6.656	7.680	8.960	9.984
8	293	2.344	2.930	3.809	4.395	5.860	7.618	8.790	10.255	11.427
9	330	2.640	3.300	4.290	4.950	6.600	8.580	9.900	11.550	12.870
10	367	2.936	3.670	4.771	5.505	7.340	9.542	11.010	12.845	14.313
11	404	3.232	4.040	5.252	6.060	8.080	10.504	12.120	14.140	15.756

Best Performance
Reduced Performance
Not Recommended

5.5.3 Human readable interpretation in GS1 DataBar symbols

For human readable interpretation rules see section [4.14](#). For HRI rules specific to regulated healthcare retail consumer trade items, see section [4.14.1](#).

5.5.4 Data transmission and symbology identifier prefixes

5.5.4.1 Default transmission mode

The GS1 system requires the use of symbology identifiers. GS1 DataBar family symbols are normally transmitted using symbology identifier prefix **je0** (see section [5.1.3](#)). For example, a GS1 DataBar symbol encoding AI (01) element string 10012345678902 produces the transmitted data string "je00110012345678902." Data transmission follows the rules for Encoding/Decoding element strings in GS1 symbologies using GS1 Application Identifiers (see section [7.8](#))

If a 2D Composite Component accompanies a GS1 DataBar family linear symbol, the AI element string data from the 2D Composite Component immediately follows the linear component's data. However, readers have an option to transmit only the linear component data and ignore the 2D Composite Component.

5.5.4.2 GS1-128 symbol emulation mode

Readers also have an option for GS1-128 symbol emulation mode. This mode emulates the GS1-128 symbology for data transmission. This mode is used for applications programmed for GS1-128 but not yet programmed to recognise the symbology identifier prefix **je0**. The symbology identifier for GS1-128 emulation mode is **Jc1**. GS1 DataBar Expanded symbols that exceed 48 data characters are transmitted as two messages so as not to exceed the maximum GS1-128 symbol message length. Each of the two messages has a symbology identifier prefix of **Jc1** and does not exceed 48 data characters. The two messages are split at a boundary between two element strings. This mode is inferior to the normal transmission mode as message integrity may be lost when a message is split.

5.5.5 Width of a module (X-dimension)

The range of the X-dimension will be defined by the application specification, having due regard to the availability of equipment for the production and reading of symbols and complying with the general requirements of the application. Symbol specifications are subject to change at the application standards level and are governed by the scanner operational environment decision tree in section [5.12.2.6](#).

The X-dimension SHALL be constant throughout a given symbol.

5.5.6 Height of symbol

The height of a symbol is a multiple of the X-dimension defined by the type of GS1 DataBar symbology given in sections [5.5.2.1.1](#), [5.5.2.1.2](#), [5.5.2.1.3](#), [5.5.2.1.4](#), [5.5.2.2](#), [5.5.2.3.1](#) and [5.5.2.3.2](#). Symbol specifications are subject to change at the application standards level and are governed by the scanner operational environment decision tree in section [5.12.2.6](#).

5.5.7 Print quality grade

The International Standard *ISO/IEC 15416* methodology is used for measuring and grading the GS1 DataBar family of symbols. The *ISO/IEC 15416* print quality specification is functionally identical to the older ANSI and CEN print quality specifications. The print quality grade is measured by verifiers that comply with the standard. The grade includes a grade level, measuring aperture and the wavelength of light used for the measurement.

Symbol specifications are subject to change at the application standards level and are governed by the scanner operational environment decision tree in section [5.12.2.6](#). For most applications, the minimum quality grade for GS1 DataBar symbols is:

1.5 / 06 / 660

Where

- 1.5 is the overall symbol quality grade.
- 06 is the measuring aperture reference number (corresponding to a 0.15 millimetre or 0.006 inch diameter aperture).
- 660 is the peak response wavelength in nanometres.

In addition to the minimum print quality grade, all elements in the row separator patterns SHOULD be visually distinguishable.

5.5.8 Advice for selecting the symbology

Any use of GS1 DataBar should comply with GS1 system global application guidelines. GS1 DataBar is not meant to replace other GS1 system symbologies. Existing applications that are satisfactorily utilising EAN/UPC symbols, ITF-14 symbols, or GS1-128 symbols should continue to use them.

 **Note:** Scanning systems that need to read GS1 DataBar symbols must be appropriately programmed.

If GS1 DataBar is used on items that will be read by omnidirectional slot scanners, then GS1 DataBar Omnidirectional, GS1 DataBar Stacked Omnidirectional, GS1 DataBar Expanded or GS1 DataBar Expanded Stacked SHOULD be used. If only an AI (01) is to be encoded, then GS1 DataBar Omnidirectional or GS1 DataBar Stacked Omnidirectional SHOULD be used. The selection of one or the other depends on the aspect ratio of the area available for the symbol.

If supplementary GS1 Application Identifier (AI) element strings are required or the primary identification has an AI other than AI (01), then GS1 DataBar Expanded or GS1 DataBar Expanded Stacked must be used. The selection of one or the other depends on the width of the print head or the area available for the symbol.

When using GS1 DataBar Expanded or GS1 DataBar Expanded Stacked symbols to encode the Global Trade Item Number (GTIN), any required additional data SHOULD be included within the same symbol.

If GS1 DataBar is used on small items that do not need omnidirectional scanning capability, then GS1 DataBar Stacked, GS1 DataBar Limited, or GS1 DataBar Truncated SHOULD be used. GS1 DataBar Limited cannot be used to encode a GTIN-14 data structure with an indicator value greater than 1. Otherwise GS1 DataBar Truncated or GS1 DataBar Stacked must be used. GS1 DataBar Stacked is the smallest symbol; however, as the heights of both rows are very low, it is harder to scan and cannot be used with wand scanners. If space is available, GS1 DataBar Limited can be used for number structures that it can encode. Otherwise GS1 DataBar Truncated SHOULD be used for GTIN-14 data structures with an indicator value greater than 1.

If the symbol is a GS1 DataBar Composite symbol, then using a wider GS1 DataBar symbol such as GS1 DataBar Truncated instead of GS1 DataBar Limited may be preferable because the wider companion 2D Composite Component may result in a GS1 DataBar Composite symbol of lower overall height even though the GS1 DataBar component itself is slightly taller.

If the data capacity in a two-column or three-column CC-B 2D Composite Component is inadequate to encode the required 2D component’s data message, then the linear component can be changed to increase the number of columns of the companion CC-B component. This will increase the maximum data capacity of the CC-B component as shown in the figure below.

Figure 5.5.8-1. Data capacity of CC-B

Number of CC-B columns	Used with	Maximum numeric characters	Maximum alpha characters
2	GS1 DataBar Stacked GS1 DataBar Stacked Omnidirectional	95	55
3	GS1 DataBar Limited	219	127
4	GS1 DataBar Omnidirectional GS1 DataBar Expanded GS1 DataBar Expanded Stacked	338	196

5.6 Two-dimensional barcodes - GS1 DataMatrix symbology

5.6.1 Introduction

This section of the *GS1 General Specifications* addresses some of the technical aspects of the two-dimensional barcode symbology called GS1 DataMatrix. GS1 DataMatrix is a standalone, two-dimensional barcode symbology that is made up of square modules arranged within a perimeter finder pattern. Unlike a Composite Component symbol (see section 5.11.1), GS1 DataMatrix does not require a linear symbol. GS1 DataMatrix has been used in the public domain since 1994.

This section provides only a brief technical description and overview of the GS1 DataMatrix symbology. A more detailed technical specification can be found in the International Standard *ISO/IEC 16022*. The GS1 system has adopted GS1 DataMatrix partly because, like GS1 QR Code, GS1 DataMatrix can encode GS1 system data structures and offers other technical advantages. Its compact design and the existence of various production methods that accommodate placing the symbology onto various substrates offer certain advantages over other symbologies currently in the GS1 system.

Data Matrix ISO version ECC 200 is the only version that supports GS1 system data structures, including Function 1 Symbol Character (FNC1). The ECC 200 version of Data Matrix uses Reed-Solomon error correction and this feature helps correct for partially damaged symbols. In the remainder of this section, the ECC 200 version of Data Matrix is assumed when the symbology is described as GS1 DataMatrix. This version of Data Matrix is similar in stability to ISO versions of current GS1 system symbologies.

Implementation of GS1 DataMatrix SHALL be done per approved GS1 system application guidelines. This section will not describe the specific applications. The user needs to refer to specific application standards and guidelines in other sections of these *GS1 General Specifications* as they are approved

for use. However, some of the production processes that are used to produce GS1 DataMatrix symbols are as follows:

- Direct part marking, such as is done by dot peening on items, such as automotive, aircraft metal parts, medical instruments and surgical implants.
- Laser or chemically etched parts with low contrast or light marked elements on a dark background (e.g., circuit boards and electronic components, medical instruments, surgical implants).
- High-speed ink jet printed parts and components where the marked dots cannot form a scannable linear symbol.
- Very small items that require a symbology with a square aspect ratio and/or cannot be marked within the allocated packaging space by existing GS1 DataBar and Composite symbols.
- Use with B2C Extended Packaging applications.

GS1 DataMatrix symbols are read by two-dimensional imaging scanners or vision systems. Most other scanners that are not two-dimensional imagers cannot read GS1 DataMatrix. GS1 DataMatrix symbols are restricted for use with applications that will involve imaging scanners throughout the supply chain.

5.6.2 GS1 DataMatrix features and symbol basics

Figure 5.6.2-1. GS1 DataMatrix symbol



- Figure [5.6.2-1](#) represents a GS1 DataMatrix symbol with 20 rows and 20 columns (including the perimeter finder pattern but not including Quiet Zones).
- GS1 DataMatrix solid "L" shaped finder or alignment pattern is one module wide.
- GS1 DataMatrix Quiet Zone is one module wide on all four sides. As with other barcode Quiet Zones, do not print in this area.
- ECC 200 symbols can always be recognised from older versions of Data Matrix because the corner opposite the middle of the finder pattern is a zero module or white in normal print.
- For square GS1 DataMatrix symbols, only an even number of rows and columns exist. Depending on data requirements, symbols can range from 10 row by 10 columns (10 x10) to 144x144 (including finder pattern but not the Quiet Zone).
- For normal printing, a module is one X by one X in dimension. Representation of data: A dark module is a binary one and a light module is a binary zero (or a light module is a binary one and a dark module is a binary zero for a symbol with reflectance reversal).
- ECC 200 (ECC = Error Checking and Correction) that uses Reed-Solomon error correction. Figure [5.6.3.2-1](#) *ECC 200 Square Symbol attributes*, shows the fixed amounts of error correction associated for each allowable Data Matrix symbol size.
- FNC1 for GS1 system compatibility SHALL be encoded at the beginning of the data string. When a separator character is needed at the end of an element string, either the Function 1 Symbol Character (FNC1) or the control character <GS> (ASCII value 29 (decimal), 1D (hexadecimal)) SHALL be used and SHALL be represented in the transmitted message by control character <GS> (ASCII value 29 (decimal), 1D (hexadecimal)).
- Encodable character set:

- The GS1 system requires that only the subset of *ISO/IEC 646 International Reference Version* defined in these *GS1 General Specifications* be used for GS1 Application Identifier (AI) element strings. Refer to figure [7.11-1](#) for the allowed encodable character set.
- Data characters per symbol (for the maximum symbol size):
 - Alphanumeric data: up to 2335 characters.
 - Eight-bit byte data: 1556 characters.
 - Numeric data: 3116 digits.
- Large, square ECC symbols (at least 32 X32) will include alignment patterns to separate the data regions.
- Code type: matrix (Composite Component is a stacked type).
- Orientation independence: Yes (requires a two-dimensional imaging scanner).
- Summary of additional features inherent or optional in GS1 DataMatrix:
 - Reflectance reversal: (Inherent) Symbols can be read when marked so that the image is either dark on light or light on dark.
 - Rectangular symbols: Six symbol formats are specified in a rectangular form.
 - Extended Channel Interpretation (ECI) capability allows GS1 DataMatrix to encode data from other alphabets.

5.6.3 GS1 DataMatrix symbology

The technical description of GS1 DataMatrix contained within this section provides additional information based on *ISO technical specification 16022* and it is provided as a further aid in the development of specific applications. GS1 DataMatrix symbols shown in the following subsections have been magnified to show detail.

5.6.3.1 Square and rectangular formats

GS1 DataMatrix may be printed in a square or rectangular format. The square format is usually used as it has a larger range of sizes and is the only format available for symbols encoding a large amount of data. The largest rectangular symbol can encode 98 digits, while the largest square symbol can encode 3,116 digits. An enlarged rectangular symbol and an equivalent square symbol are shown in the figure below.

Figure 5.6.3.1-1. Rectangular and square GS1 DataMatrix symbols
(Specific applications are not used in the data encodation.
Both symbols contain the same data)

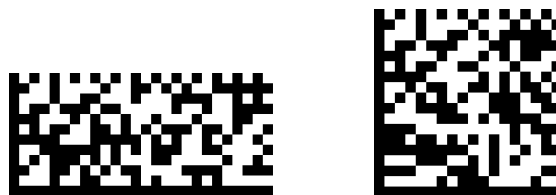

5.6.3.2 GS1 DataMatrix symbol sizes

GS1 DataMatrix symbology has multiple sizes to match various data content (see figure below). GS1 DataMatrix symbols have 24 sizes of the square format ranging from 10 by 10 modules up to 144 by 144 modules, not including the 1-X surrounding Quiet Zone. The rectangular format has 6 sizes from 8 by 18 modules up to 16 by 48 modules, not including the 1-X surrounding Quiet Zone. GS1 DataMatrix sizes of 52 by 52 or larger have 2 to 10 interleaved blocks of Reed-Solomon error correction codewords.

The term “codeword” is used often to describe attributes concerning the encodation of data into GS1 DataMatrix symbols. *ISO 16022* defines codeword as “A symbol character value. An intermediate

level of coding between source data and the graphical encodation in the symbol.” Codewords are typically eight bits of data. FNC1, two numerics and one alpha all take up one codeword each.

Figure 5.6.3.2-1. ECC 200 square symbol attributes (*)**

Symbol size (*)		Data region		Mapping	Total		Reed-Solomon		Inter-leaved	Data capacity			Error	Max. Correctable
				Matrix	Codewords		Block			Num.	Alphanum.	Byte	Correction	Codeword
Row	Col	Size	No.	Size	Data	Error	Data	Error	Blocks	Cap.	Cap.	Cap.	Overhead %	Error/Erasure
10	10	8x8	1	8x8	3	5	3	5	1	6	3	1	62.5	2/0
12	12	10x10	1	10x10	5	7	5	7	1	10	6	3	58.3	3/0
14	14	12x12	1	12x12	8	10	8	10	1	16	10	6	55.6	5/7
16	16	14x14	1	14x14	12	12	12	12	1	24	16	10	50	6/9
18	18	16x16	1	16x16	18	14	18	14	1	36	25	16	43.8	7/11
20	20	18x18	1	18x18	22	18	22	18	1	44	31	20	45	9/15
22	22	20x20	1	20x20	30	20	30	20	1	60	43	28	40	10/17
24	24	22x22	1	22x22	36	24	36	24	1	72	52	34	40	12/21
26	26	24x24	1	24x24	44	28	44	28	1	88	64	42	38.9	14/25
32	32	14x14	4	28x28	62	36	62	36	1	124	91	60	36.7	18/33
36	36	16x16	4	32x32	86	42	86	42	1	172	127	84	32.8	21/39
40	40	18x18	4	36x36	114	48	114	48	1	228	169	112	29.6	24/45
44	44	20x20	4	40x40	144	56	144	56	1	288	214	142	28	28/53
48	48	22x22	4	44x44	174	68	174	68	1	348	259	172	28.1	34/65
52	52	24x24	4	48x48	204	84	102	42	2	408	304	202	29.2	42/78
64	64	14x14	16	56x56	280	112	140	56	2	560	418	277	28.6	56/106
72	72	16x16	16	64x64	368	144	92	36	4	736	550	365	28.1	72/132
80	80	18x18	16	72x72	456	192	114	48	4	912	682	453	29.6	96/180
88	88	20x20	16	80x80	576	224	144	56	4	1152	862	573	28	112/212
96	96	22x22	16	88x88	696	272	174	68	4	1392	1042	693	28.1	136/260
104	104	24x24	16	96x96	816	336	136	56	6	1632	1222	813	29.2	168/318
120	120	18x18	36	108x108	1050	408	175	68	6	2100	1573	1047	28	204/390
132	132	20x20	36	120x120	1304	496	163	62	8	2608	1954	1301	27.6	248/472
144	144	22x22	36	132x132	1558	620	156	62	8 (**)	3116	2335	1556	28.5	310/590
							155	62	2 (**)					

Figure 5.6.3.2-2. ECC 200 Rectangular symbol attributes (*)**

Symbol size (*)		Data region		Mapping	Total		Reed-Solomon		Inter-leaved	Data capacity			Error	Max. Correctable
				Matrix	Codewords		Block			Num.	Alphanum.	Byte	Correction	Codeword
Row	Col	Size	No.	Size	Blocks	Cap.	Cap.	Cap.	Blocks	Cap.	Cap.	Cap.	Overhead %	Error/Erasure
8	18	6x16	1	6x16	5	7	5	7	1	10	6	3	58.3	3/+
8	32	6x14	2	6x28	10	11	10	11	1	20	13	8	52.4	5/+
12	26	10x24	1	10x24	16	14	16	14	1	32	22	14	46.7	7/11
12	36	10x16	2	10x32	22	18	22	18	1	44	31	20	45.0	9/15
16	36	14x16	2	14x32	32	24	32	24	1	64	46	30	42.9	12/21
16	48	14x22	2	14x44	49	28	49	28	1	98	72	47	36.4	14/25

(*) Symbol size does not include Quiet Zones.

(**) In the largest symbol (144x144), the first eight Reed-Solomon blocks SHALL be 218 codewords long encoding 156 data codewords. The last two blocks SHALL encode 217 codewords (155 data codewords). All the blocks have 62 error correction codewords.

(***) Equivalent to Table 7 in the International Standard *ISO-16022*, second edition, 2006-09-15.

The square format is divided into 4 to 36 data regions for symbols sized 32 by 32 modules and larger. The rectangular format symbols may also be divided into two data regions. Each data region is separated from the other regions by alignment patterns that consist of an alternating pattern of ones and zeroes and a solid line of ones (a dark line when there is no reflectance reversal). Figure 5.6.3.2-3 shows a four-segment square symbol on the left and a two-segment rectangular symbol on the right, each with hypothetical data shown to create the effect.

Figure 5.6.3.2-3. Segmented GS1 DataMatrix symbols: Square and rectangular formats (sizes of these GS1 DataMatrix symbols are larger than what would be used in a typical application so that typical alignment patterns can be easily seen.)

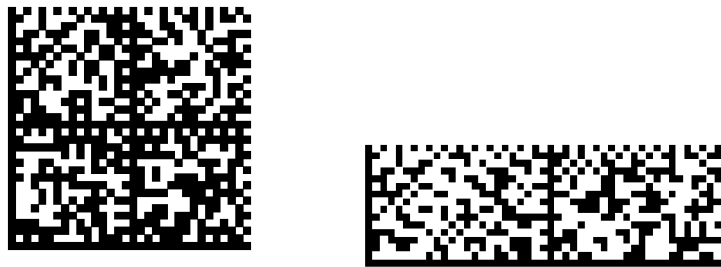

5.6.3.3 Data transmission and symbology identifier prefixes

The GS1 system requires the use of symbology identifiers. GS1 DataMatrix uses the symbology identifier of **jd2** (see figure below) for GS1 system compliant symbols that have a leading FNC1 character. This indicates that GS1 Application Identifier (AI) data is encoded equivalent to the symbology identifier **JC1** for GS1-128 symbols and **je0** for GS1 DataBar and Composite symbols. For more information on symbology identifiers, see the International Standard *ISO/IEC 15424 Information technology — Automatic identification and data capture techniques — Data Carrier Identifiers*.

For example, a GS1 DataMatrix symbol encoding AI (01) element string 10012345678902 produces the transmitted data string “]d20110012345678902.” Data transmission follows the same principles that apply to the concatenation of AI element strings in any GS1 barcode that encodes GS1 Application Identifiers (see section 7.8).

Figure 5.6.3.3-1. Symbology identifier for Data Matrix ECC 200

	Message content	Separator
]d2	Standard AI element strings	None

5.6.3.4 Width and height of a module (X)

The range of the X-dimensions will be defined by the application specification, having due regard to the availability of equipment for the production and reading of symbols and complying with the general requirements of the application.

The X-dimension SHALL be constant throughout a given symbol. The X-dimension applies to both the width and height of the modules.

5.6.3.5 Symbol quality grade

The International Standard *ISO/IEC 15415 Information technology - Automatic identification and data capture techniques – Bar code symbol print quality test specification - Two-dimensional symbols methodology* SHALL be used for measuring and grading GS1 DataMatrix. The print quality grade is measured by verifiers that comply with the standard. The grade includes a grade level, measuring aperture, the wavelength of light used for the measurement and the illumination angle relative to the symbol.

A symbol grade is only meaningful if it is reported in conjunction with the illumination and aperture used. It is shown in the format grade/aperture/light/angle, where:

- **"grade"** is the overall symbol grade as defined in *ISO/IEC 15415 Information technology - Automatic identification and data capture techniques – Bar code symbol print quality test specification - Two-dimensional symbols* (e.g., the arithmetic mean to one decimal place of the Scan Reflectance Profile or scan grades). For GS1 DataMatrix, the grade number may be followed by an asterisk (*) which indicates that the surroundings of the symbol contain extremes of reflectance that may interfere with reading. For most applications, this should be specified as causing the symbol to fail.
- **"aperture"** is the diameter in thousandths of an inch (to the nearest thousandth) of the synthetic aperture defined in *ISO/IEC 15415 Information technology - Automatic identification and data capture techniques – Bar code symbol print quality test specification - Two-dimensional symbols*.
- **"light"** defines the illumination: A numeric value indicates the peak light wavelength in nanometres (for narrow band illumination); the alphabetic character W indicates that the symbol has been measured with broadband illumination (white light) the spectral response characteristics of which must imperatively be defined or have their source specification clearly referenced.
- **"angle"** is an additional parameter defining the angle of incidence (relative to the plane of the symbol) of the illumination. It SHALL be included in the reporting of the overall symbol grade when the angle of incidence is other than 45 degrees. Its absence indicates that the angle of incidence is 45 degrees.



Note: This international standard provides for 30 degrees and 90 degrees illumination in addition to the default 45 degrees.

The aperture is normally specified as being 80% of the minimum X-dimension allowed for the application. The printing method must produce the GS1 DataMatrix "L" pattern with gaps between the dots less than 25% of the specified aperture. If symbols with greater than the minimum X dimension are allowed by the application, the same absolute maximum gap dimension must be maintained.

Examples:

- 2.8/05/660 would indicate that the average of the grades of the Scan Reflectance Profiles, or of the scan grades, was 2.8 when these were obtained with the use of a 0.125 millimetre aperture (ref. No. 05) and a 660 nanometre light source, incident at 45 degrees.
- 2.8/10/W/30 would indicate the grade of a symbol intended to be read in broadband light, measured with light incident at 30 degrees and using a 0.250 millimetre aperture (ref. No. 10), but would need to be accompanied either by a reference to the application specification defining the reference spectral characteristics used for measurement or a definition of the spectral characteristics themselves.
- 2.8/10/660* would indicate the grade of a symbol measured using a 0.250 millimetre aperture (ref. No. 10), a 660 nanometre light source and indicates the presence of a potentially interfering extreme reflectance value in the surroundings of the symbol.

Recommended symbol grades for GS1 DataMatrix are identified in individual applications in section [5.12](#).

5.6.3.6 Advice for selecting the symbology

Any use of GS1 DataMatrix should comply with GS1 system global application guidelines and be restricted to those applications defined by the GS1 system for GS1 DataMatrix. GS1 DataMatrix will not replace other GS1 system symbologies. Existing applications that are satisfactorily utilising EAN/UPC symbols, ITF-14 symbols, GS1-128 symbols, GS1 DataBar symbols, or Composite symbols should continue to use them.

When using GS1 DataMatrix symbols to encode the Global Trade Item Number (GTIN), any required additional data SHOULD be included within the same symbol.

-  **Note:** Scanning systems that need to read GS1 DataMatrix symbols must be 2D imaging scanners and be appropriately programmed to read the GS1 system version of Data Matrix or ECC 200.

5.6.3.7 Human readable interpretation of GS1 DataMatrix symbols

For human readable interpretation rules see section [4.14](#). For HRI rules specific to regulated healthcare retail consumer trade items, see section [4.14.1](#).

5.7 Two-dimensional barcodes - GS1 QR Code symbology

5.7.1 Introduction

This section of the *GS1 General Specifications* addresses some of the technical aspects of the two-dimensional barcode symbology called GS1 QR Code. GS1 QR Code is a standalone, two-dimensional barcode symbology that is made up of square modules arranged in an overall square pattern, including a unique finder pattern located at three corners of the symbol. Unlike a Composite Component symbol (see section [5.11](#)), GS1 QR Code does not require a linear symbol.

This section provides only a brief technical description and overview of the GS1 QR Code symbology. A more detailed technical specification can be found in *ISO/IEC 18004:2015 Information technology -- Automatic identification and data capture techniques -- QR Code bar code symbology specification*. ISO/IEC QR Code also contains specifications for Micro QR Code, but this symbology is not supported in the GS1 system.

The GS1 system has adopted GS1 QR Code partly because, like GS1 DataMatrix, GS1 QR Code can encode GS1 system data structures and offers other technical advantages. Its compact design and the existence of various production methods that accommodate placing the symbology onto various substrates offer certain advantages over other symbologies currently in the GS1 system.

QR Code supports all GS1 system data structures, including Function 1 Symbol Character (FNC1). QR Code uses Reed-Solomon error correction (four selectable levels of error correction are specified) and this feature helps correct for partially damaged symbols.

Implementation of GS1 QR Code SHALL be done per approved GS1 system application standards. This section will not describe the specific applications. The user needs to refer to specific application standards in other sections of these *GS1 General Specifications* as they are approved for use.

GS1 QR Code symbols are read by two-dimensional imaging scanners or vision systems. Most other scanners that are not two-dimensional imagers cannot read GS1 QR Code. GS1 QR Code symbols are restricted for use with applications that will involve imaging scanners throughout the supply chain.

5.7.2 GS1 QR Code features and symbol basics

GS1 QR Code is a subset of ISO/IEC QR Code that is a matrix symbology with the following characteristics:

Formats:

- QR Code, with full range of capabilities and maximum data capacity.
- Not supported for the GS1 system: Micro QR Code, with reduced overhead, some restrictions on capabilities and reduced data capacity.

Encodable character set

- numeric data: digits 0 - 9
- alphabetic data: upper case letters A - Z
- nine special characters: space \$ % * + - . / :

Note: More information on how to encode the % special character can be found in *ISO/IEC 18004:2015*.

- byte data (default: *ISO/IEC 8859-1*; or other sets as otherwise defined in byte mode, data is encoded at 8 bits per character. In closed-system national or application-specific implementations of QR Code, an alternative 8-bit character set, for example as defined in an appropriate part of *ISO/IEC 8859*, may be specified for byte mode. When an alternative character set is specified, however, the parties intending to read the QR Code symbols require to be notified of the applicable character set in the application specification or by bilateral agreement.
- Not supported for the GS1 system: Kanji characters (Kanji characters in QR Code can be compacted into 13 bits).

Representation of data:

A dark module is nominally a binary one and a light module is nominally a binary zero. However, reflectance reversal is provided as an option.

Symbol size (not including Quiet Zone):

GS1 QR Code symbols: 21 x 21 modules to 177 x 177 modules (Versions 1 to 40, increasing in steps of four modules per side).

Data characters per symbol

- maximum QR Code symbol size, Version 40-L:
- numeric data: 7,089 characters.
- alphanumeric data: 4,296 characters.
- Byte data: 2,953 characters.
- Kanji data: 1,817 characters (Not supported for the GS1 system).

Selectable error correction:

Four levels of Reed-Solomon error correction (referred to as L, M, Q and H in increasing order of capacity) allowing recovery of:

- L 7% of the symbol codewords.
- M 15% of the symbol codewords.
- Q 25% of the symbol codewords.
- H 30% of the symbol codewords.

Orientation independence:

- both rotation and reflection

Figure [5.7.3-1](#) illustrates a QR Code symbol in normal colour and with reflectance reversal in both normal and mirror image orientations.

5.7.3 Summary of additional features

The use of the following additional features is optional in QR Code; some of these features are not supported for GS1 system use.

Reflectance reversal

Symbols are intended to be read when marked so that the image is either dark on light or light on dark (figure [5.7.3-1](#)). The specifications in this document are based on dark images on a light background, therefore in the case of symbols produced with reflectance reversal references to dark or light modules should be taken as references to light or dark modules respectively. See note below figure [5.12.3.1-2](#) for more information.

Mirror imaging

The arrangement of modules defined in this International Standard represents the "normal" orientation of the symbol. It is, however, possible to achieve a valid decode of a symbol in which the arrangement of the modules has been laterally transposed. When viewed with the finder patterns at the top left, top right and bottom left corners of the symbol, the effect of mirror imaging is to interchange the row and column positions of the modules. See note below figure [5.12.3.1-2](#) for more information.

Figure 5.7.3-1. Examples of QR Code symbols

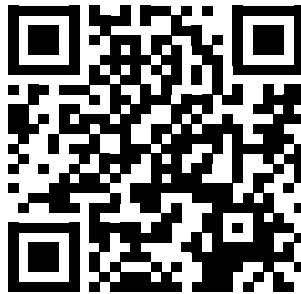

normal orientation and normal reflectance arrangement

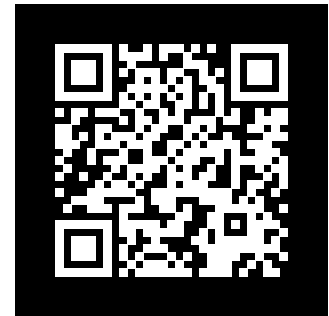

normal orientation and reversed reflectance

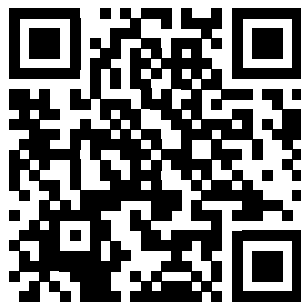

mirror image orientation and normal reflectance arrangement



mirror image orientation and reversed reflectance

Not supported for the GS1 system: Structured append

This allows files of data to be represented logically and continuously in up to 16 QR Code symbols. These may be scanned in any sequence to enable the original data to be correctly reconstructed. Structured Append is not available with Micro QR Code symbols.

Not supported for the GS1 system: Extended channel interpretations

This mechanism enables data using character sets other than the default encodable set (e.g., Arabic, Cyrillic, Greek) and other data interpretations (e.g., compacted data using defined compression schemes) or other industry-specific requirements to be encoded.

5.7.4 GS1 QR Code symbology

The technical description of GS1 QR Code contained within this section provides additional information based on *ISO/IEC technical standard 18004:2015* and it is provided as a further aid in the development of specific applications.

5.7.4.1 GS1 QR Code square format

GS1 QR Code is printed in a square format. The square format has a large range of sizes. The largest symbol (177 X 177 modules, Error Correction Level = L) can encode up to 7089 digits or 4296 alphanumeric characters technically, however permissible data is specified by the application standards.

5.7.4.2 GS1 QR Code symbol sizes

GS1 QR Code symbology has multiple sizes to match various data content (see figure 5.7.4.2-1). GS1 QR Code symbols have 40 sizes in a square format ranging from 21 by 21 modules up to 177 by 177 modules, not including the 4-X surrounding Quiet Zone.

The term "codeword" is used often to describe attributes concerning the encodation of data into GS1 QR Code. A codeword is defined as: "A symbol character value. An intermediate level of coding between source data and the graphical encodation in the symbol." Codewords are typically eight bits of data.

Figure 5.7.4.2-1. GS1 QR Code symbol size and data capacity

Version	Modules/ side	Data capacity [codewords]	Version	Modules/ side	Data capacity [codewords]
1	21	26	21	101	1 156
2	25	44	22	105	1 258
3	29	70	23	109	1 364
4	33	100	24	113	1 474
5	37	134	25	117	1 588
6	41	172	26	121	1 706
7	45	196	27	125	1 828
8	49	242	28	129	1 921
9	53	292	29	133	2 051
10	57	346	30	137	2 185
11	61	404	31	141	2 323
12	65	466	32	145	2 465
13	69	532	33	149	2 611
14	73	581	34	153	2 761
15	77	655	35	157	2 876
16	81	733	36	161	3 034
17	85	815	37	165	3 196
18	89	901	38	169	3 362
19	93	991	39	173	3 532
20	97	1 085	40	177	3 706

 **Note:** Symbol size does not include surrounding 4-X Quiet Zones.

Figure 5.7.4.2-2. GS1 QR Code symbol attributes for the first ten versions of the symbol

Version	Error correction level	Number of data codewords	Data capacity			
			Numeric	Alpha-numeric	Byte	Kanji
1	L	19	41	25	17	10
	M	16	34	20	14	8
	Q	13	27	16	11	7
	H	9	17	10	7	4

Version	Error correction level	Number of data codewords	Data capacity			
			Numeric	Alpha-numeric	Byte	Kanji
2	L	34	77	47	32	20
	M	28	63	38	26	16
	Q	22	48	29	20	12
	H	16	34	20	14	8
3	L	55	127	77	53	32
	M	44	101	61	42	26
	Q	34	77	47	32	20
	H	26	58	35	24	15
4	L	80	187	114	78	48
	M	64	149	90	62	38
	Q	48	111	67	46	28
	H	36	82	50	34	21
5	L	108	255	154	106	65
	M	86	202	122	84	52
	Q	62	144	87	60	37
	H	46	106	64	44	27
6	L	136	322	195	134	82
	M	108	255	154	106	65
	Q	76	178	108	74	45
	H	60	139	84	58	36
7	L	156	370	224	154	95
	M	124	293	178	122	75
	Q	88	207	125	86	53
	H	66	154	93	64	39
8	L	194	461	279	192	118
	M	154	365	221	152	93
	Q	110	259	157	108	66
	H	86	202	122	84	52
9	L	232	552	335	230	141
	M	182	432	262	180	111
	Q	132	312	189	130	80
	H	100	235	143	98	60
10	L	274	652	395	271	167
	M	216	513	311	213	131
	Q	154	364	221	151	93
	H	122	288	174	119	74

5.7.4.3 Data transmission and symbology identifier prefixes

The GS1 system requires the use of symbology identifiers. GS1 QR Code uses the symbology identifier of **JQ3** (see figure below) for GS1 system compliant symbols that have a leading FNC1 character. This indicates that GS1 Application Identifier (AI) data is encoded equivalent to the symbology identifier **JC1** for GS1-128 symbols, **jd2** for GS1 DataMatrix symbols and **je0** for GS1 DataBar and Composite symbols. For more information on symbology identifiers, see the International Standard *ISO/IEC 15424 Information technology – Automatic identification and data capture techniques – Data Carrier Identifiers*.

For example, a GS1 QR Code symbol encoding AI (01) element string 10012345678902 produces the transmitted data string "]Q30110012345678902." Data transmission follows the same principles that apply to the concatenation of AI element strings in any GS1 barcode that encodes GS1 Application Identifiers (see section [7.8](#)).

Figure 5.7.4.3-1. Symbology identifier for GS1 QR Code

	Message content	Separator
]Q3	Standard AI element strings	None

5.7.4.4 Width and height of a module (X)

The range of the X-dimensions will be defined by the application specification, having due regard to the availability of equipment for the production and reading of symbols and complying with the general requirements of the application.

The X-dimension SHALL be constant throughout a given symbol. The X-dimension SHOULD apply to both the width and height of the modules.

5.7.4.5 Symbol quality grade

The International Standard *ISO/IEC 15415 Information technology - Automatic identification and data capture techniques – Bar code symbol print quality test specification - Two-dimensional symbols methodology* SHALL be used for measuring and grading GS1 QR Code Symbols. The print quality grade is measured by verifiers that comply with the standard. The grade includes a grade level, measuring aperture, the wavelength of light used for the measurement and the illumination angle relative to the symbol.

A symbol grade is only meaningful if it is reported in conjunction with the illumination and aperture used. It should be shown in the format grade/aperture/light/angle, where:

- **"grade"** is the overall symbol grade as defined in *ISO/IEC 15415 Information technology - Automatic identification and data capture techniques – Bar code symbol print quality test specification - Two-dimensional symbols* (e.g., the arithmetic mean to one decimal place of the Scan Reflectance Profile or scan grades). For GS1 QR Code, the grade number may be followed by an asterisk (*) which indicates that the surroundings of the symbol contain extremes of reflectance that may interfere with reading. For most applications, this should be specified as causing the symbol to fail.
- **"aperture"** is the diameter in thousandths of an inch (to the nearest thousandth) of the synthetic aperture defined in *ISO/IEC 15415 Information technology - Automatic identification and data capture techniques – Bar code symbol print quality test specification - Two-dimensional symbols*.
- **"light"** defines the illumination: A numeric value indicates the peak light wavelength in nanometres (for narrow band illumination); the alphabetic character W indicates that the symbol has been measured with broadband illumination (white light) the spectral response characteristics of which must imperatively be defined or have their source specification clearly referenced.
- **"angle"** is an additional parameter defining the angle of incidence (relative to the plane of the symbol) of the illumination. It SHALL be included in the reporting of the overall symbol grade when the angle of incidence is other than 45 degrees. Its absence indicates that the angle of incidence is 45 degrees.

The aperture is normally specified as being 80% of the minimum X-dimension allowed for the application.

Examples:

- 2.8/05/660 would indicate that the average of the grades of the Scan Reflectance Profiles, or of the scan grades, was 2.8 when these were obtained with the use of a 0.125 millimetre aperture (ref. No. 05) and a 660 nanometre light source, incident at 45 degrees.
- 2.8/10/W/30 would indicate the grade of a symbol intended to be read in broadband light, measured with light incident at 30 degrees and using a 0.250 millimetre aperture (ref. No. 10), but would need to be accompanied either by a reference to the application specification defining the reference spectral characteristics used for measurement or a definition of the spectral characteristics themselves.

- 2.8/10/660* would indicate the grade of a symbol measured using a 0.250 millimetre aperture (ref. No. 10), a 660 nanometre light source and indicates the presence of a potentially interfering extreme reflectance value in the surroundings of the symbol.

Recommended symbol grades for GS1 QR Code are identified in individual applications in section [5.12](#).

5.7.4.6 Advice for selecting the symbology

Any use of GS1 QR Code should comply with GS1 system global application standards and be restricted to those applications defined by the GS1 system for GS1 QR Code. GS1 QR Code will not replace other GS1 system symbologies. Existing applications that are satisfactorily utilising EAN/UPC symbols, ITF-14 symbols, GS1-128 symbols, GS1 DataBar symbols, GS1 DataMatrix or GS1 composite symbols should continue to use them.

- ✓ **Note:** Scanning systems that need to read GS1 QR Code symbols must be 2D imaging scanners and be appropriately programmed to read the GS1 system versions of *ISO/IEC 18004:2015*.

5.7.4.7 Human readable interpretation of GS1 QR Code symbols

For human readable interpretation rules see section [4.14](#).

5.8 Two dimensional barcodes - GS1 DotCode symbology

5.8.1 Introduction

This section provides a summary description and overview of the GS1 DotCode symbology. A more detailed technical specification can be found in the *Information Technology – Automatic Identification and Data Capture Techniques – Bar Code Symbology Specifications – DotCode, Rev 3.0, August 2014* which is available from AIM. When AIM DotCode encodes GS1 system data, it is referred to as GS1 DotCode.

The GS1 system has adopted GS1 DotCode based on its ability to encode GS1 identification keys while printing the barcode inline at high production speeds. Implementation of GS1 DotCode SHALL be per approved GS1 system application standard section [2.1.14](#).

5.8.2 GS1 DotCode symbology

The technical description of GS1 DotCode contained within this section provides additional information based on *AIM DotCode Specification*. It is provided as a further aid in the development of specific applications.

Not supported for the GS1 system: Structured append

This feature allows files of data to be represented logically and continuously in DotCode symbols. These may be scanned in any sequence to enable the original data to be correctly reconstructed.

Not supported for the GS1 system: Extended channel interpretations

This mechanism enables data using character sets other than the default encodable set (e.g., Arabic, Cyrillic, Greek) and other data interpretations (e.g., compacted data using defined compression schemes) or other industry-specific requirements to be encoded.

5.8.2.1 Data transmission and symbology identifier prefixes

The GS1 system requires the use of symbology identifiers. GS1 DotCode uses the symbology identifier of "]J1" (see figure below) for GS1 system compliant symbols. This indicates that Application Identifier (AI) data is encoded equivalent to the symbology identifier "]C1" for GS1-128 symbols,]d2 for GS1 DataMatrix symbols,]Q3 for QR Code symbols and "]e0" for GS1 DataBar and Composite symbols. For more information on symbology identifiers, see the International Standard

ISO/IEC 15424 Information technology — Automatic identification and data capture techniques — Data Carrier Identifiers.

For example, a GS1 DotCode symbol encoding AI (01) element string 10012345678902 produces the transmitted data string "]J10110012345678902." Data transmission follows the same principles that apply to the concatenation of AI element strings in any GS1 barcode that encodes Application Identifiers (see section [7.8](#)).

Figure 5.8.2.1-1. Symbology identifier for GS1 DotCode

	Message content	Separator
]J1	Standard AI element strings	None

5.8.2.2 Width and height of a module (X)

The range of the X-dimensions will be defined by the application specification, having due regard to the availability of equipment for the production and reading of symbols and complying with the general requirements of the application.

The X-dimension SHALL be constant throughout a given symbol. The X-dimension refers to both the width and height of the modules.

5.8.2.3 Symbol quality grade

The International Standard *ISO/IEC 15415 Information technology - Automatic identification and data capture techniques – Bar code symbol print quality test specification - Two-dimensional symbols methodology* SHALL be used for measuring and grading GS1 DotCode Symbols as augmented in the AIM DotCode Specification.

Minimum symbol grades for GS1 DotCode are specified in individual applications standards in section [2](#) which refer to symbol specification tables in section [5.12.3.12](#).

5.8.2.4 Advice for selecting the symbology

GS1 DotCode SHALL only be used to meet the requirements of the EU tobacco traceability regulation EU 2018/574 as set out in section [2.1.14](#).

5.8.2.5 Human readable interpretation of GS1 DotCode symbols

For human readable interpretation rules see section [4.14](#).

5.9 Two dimensional barcodes - Data Matrix symbology

Data Matrix implementing ECC 200 error correction is an International Standard *ISO/IEC 16022*. Data Matrix is only used by the GS1 system to encode the GS1 Digital Link URI syntax. For full technical aspects of Data Matrix, see *ISO/IEC 16022*.

5.10 Two dimensional barcodes - QR Code symbology

QR Code is an International Standard *ISO/IEC 18004*. QR Code is only used by the GS1 system to encode the GS1 Digital Link URI syntax. For full technical aspects of QR Code, see *ISO/IEC 18004*.

5.11 Composite barcodes

5.11.1 Composite symbology introduction

The Composite symbology integrates both a GS1 system linear symbol and a 2D Composite Component as a single symbology. There are three types of Composite symbols A, B and C, each with different encoding rules. The encoder model is designed to automatically select the appropriate type and optimise.

The linear component encodes the item's primary identification. The adjacent 2D Composite Component encodes supplementary data, such as a batch number and expiration date. The Composite symbol always includes a linear component so that the primary identification is readable by all scanning technologies. The Composite symbol always includes a multi-row 2D Composite Component that can be read with linear- and area-CCD scanners and with linear and rastering laser scanners.

The Composite symbology is described in the *Association for Automatic Identification and Mobility AIM ITS 99-002 - International Symbology Specification - Composite Symbology*.

5.11.1.1 Composite symbology characteristics

The characteristics of the Composite symbology are:

- Encodable character set:
 - Both linear and 2D components encode a subset of *ISO/IEC 646*. Refer to figure [7.11-1](#) for the allowed encodable character set.
 - The Function 1 Symbol Character (FNC1), and a Symbol Separator character.
- Symbol character structure: Various (n,k) symbol characters are used in accordance with the underlying symbology of the selected linear and 2D Composite Components of the symbol.
- Code type:
 - Linear component: continuous, linear barcode symbology.
 - 2D Composite Component: continuous, multi-row barcode symbology.
- Maximum numeric data capacity:
 - Linear component:
 - GS1-128 symbol: up to 48 digits.
 - EAN/UPC symbol: 8, 12, or 13 digits.
 - GS1 DataBar Expanded symbol: up to 74 digits.
 - Other GS1 DataBar symbols: 16 digits.
 - 2D Composite Component:
 - CC-A: up to 56 digits.
 - CC-B: up to 338 digits.
 - CC-C: up to 2,361 digit.
- Error detection and correction:
 - Linear component: a modulo check value for error detection.
 - 2D Composite Component: a fixed or variable number of Reed-Solomon error correction codewords, depending upon the specific 2D Composite Component.
- Character self-checking.
- Bi-directionally decodable.

5.11.1.2 Additional features

The following is a summary of additional Composite symbology features:

- Data compaction: The 2D Composite Components utilise a bit-oriented compaction mode designed to encode data efficiently using GS1 Application Identifiers (AIs).
- Component linkage: The 2D Composite Component of each Composite symbol contains a linkage flag, which indicates to the reader that no data shall be transmitted unless the associated linear component is also scanned and decoded. All linear components except EAN/UPC symbols also contain an explicit linkage flag.
- GS1-128 symbol emulation: Readers set to the GS1-128 symbol emulation mode transmit the data encoded within the Composite symbol as if the data were encoded in one or more GS1-128 symbols.

- A symbol separator character: A flag character to support future applications that instructs the reader to terminate transmission of the message at that point and to transmit the remaining data as a separate message
- 2D Composite Component escape mechanism: A mechanism to support future GS1 system applications that require characters beyond the *ISO/IEC 646* character subset defined for GS1 Application Identifier (AI) element string data (see figure [7.11-1](#)).

5.11.2 Symbol structure

Each Composite symbol consists of a linear component and a multi-row 2D Composite Component. The 2D Composite Component is printed above the linear component. The two components are separated by a separator pattern. Up to 3X of light space is permitted between the separator pattern and 2D Composite Component to facilitate printing the two components separately; however, if the two components are printed at one time, the nominal alignment is followed as shown in the figure below.

Figure 5.11.2-1. GS1 DataBar Limited Composite symbol with CC-A



(01)13112345678906(17)010615(10)A123456

In figure [5.11.2-1](#), the AI (01) Global Trade Item Number (GTIN) is encoded in the GS1 DataBar Limited linear component. The AI (17) expiration date and the AI (10) lot number are encoded in the CC-A 2D Composite Component.

The linear component is one of the following:

- A member of the EAN/UPC symbology (EAN-13, EAN-8, UPC-A, or UPC-E).
- A member of the GS1 DataBar family.
- A GS1-128 symbol.

The choice of linear component determines the name of the Composite symbol, such as an EAN-13 Composite symbol, or a GS1-128 Composite symbol.

The 2D Composite Component (abbreviated as CC) is chosen based on the selected linear component and on the amount of supplementary data to be encoded. The three 2D Composite Components, listed in order of increasing maximum data capacity, are:

- CC-A: a variant of MicroPDF417.
- CC-B: a MicroPDF417 symbol with new encoding rules.
- CC-C: a PDF417 symbol with new encoding rules.

Figure 5.11.2-2. GS1-128 Composite symbol with CC-C



(01)03812345678908(10)ABCD123456(410)3898765432108

In figure [5.11.2-2](#), the AI (01) GTIN is encoded in the GS1-128 symbol linear component. The AI (10) lot number and the AI (410) ship-to location are encoded in the CC-C 2D Composite Component. Based upon the width of the linear component, a choice of "best-fit" 2D Composite Component is specified. figure [5.11.2-3](#) lists all of the permissible combinations.

Figure 5.11.2-3. Permissible combinations of linear and 2D Composite Components

Linear component	CC-A/CC-B	CC-C
UPC-A and EAN-13	Yes (4-columns)	No
EAN-8	Yes (3-columns)	No
UPC-E	Yes (2-columns)	No
GS1-128	Yes (4-columns)	Yes (variable width)
GS1 DataBar Omnidirectional and GS1 DataBar Truncated	Yes (4-columns)	No
GS1 DataBar Stacked and GS1 DataBar Stacked Omnidirectional	Yes (2-columns)	No
GS1 DataBar Limited	Yes (3-columns)	No
GS1 DataBar Expanded and GS1 DataBar Expanded Stacked	Yes (4-columns)	No

5.11.2.1 CC-A structure

CC-A is a variant of MicroPDF417 with a unique combination of row address patterns (RAP). It is the smallest of the 2D Composite Components and can encode up to 56 digits. It has from 3 to 12 rows and 2 to 4 columns.

Each row is a minimum of 2X high (where X is the width of a module, narrow bar, or space). A 1X high minimum separator pattern is positioned between the linear component and 2D Composite Component. (A different separator pattern, 6X high, is used in Composite symbols with EAN/UPC linear components).

Each column contains one $n,k = 17,4$ data or error correction character (codeword) per row (n is the number of modules and k is the number of bars and also the number of spaces). So, the width of a codeword is 17X.

In addition to the codeword columns, CC-A has two or three $n,k = 10,3$ RAP columns that encode the row numbers (each 10X wide). The rightmost RAP column is terminated on the right by a 1X bar, so it is 11X instead of 10X wide.

Each row also requires a 1X Quiet Zone at each end. There is no Quiet Zone required above CC-A. The separator pattern is printed directly above the linear component and no Quiet Zone is required below the CC-A.

The two-column and three-column CC-A versions have two RAP columns and the four-column CC-A version has three RAP columns, as shown in the figure below.

Figure 5.11.2.1-1. CC-A column structures

Two-column CC-A structure

Quiet Zone	RAP column	Codeword column	Codeword column	RAP column	Quiet Zone
------------	------------	-----------------	-----------------	------------	------------

Three-column CC-A structure

Quiet Zone	Codeword column	RAP column	Codeword column	Codeword column	RAP column	Quiet Zone
------------	-----------------	------------	-----------------	-----------------	------------	------------

Four-column CC-A structure

Quiet Zone	RAP column	Codeword column	Codeword column	RAP column	Codeword column	Codeword column	RAP column	Quiet Zone
------------	------------	-----------------	-----------------	------------	-----------------	-----------------	------------	------------

Figure [5.11.2.1-2](#) lists all possible column and row combinations for CC-A. It also shows the capacity and size of the 2D Composite Components. For example, a two-column, five-row CC-A would be 57X wide (including 1X for the extra right-most guard bar) by 10X high (not including the separator pattern). With an X-dimension of 0.254 millimetre (0.0100 inch), it would be 14.48 millimetres (0.57 inch) wide by 2.54 millimetre (0.100 inch) high.

Figure 5.11.2.1-2. CC-A Row and column sizes

Number of data columns (c)	Number of rows (r)	Total CWs in data region	Number of EC CWs (k)	Percent of CWs for ec	Number of CWs for data	Max alpha chars	Max digits	Component width, in X (see note 1)	Component height, in X (see note 2)
2	5	10	4	40.00%	6	8	16	57	10
2	6	12	4	33.33%	8	12	22	57	12
2	7	14	5	35.71%	9	13	24	57	14
2	8	16	5	31.25%	11	17	30	57	16
2	9	18	6	33.33%	12	18	33	57	18
2	10	20	6	30.00%	14	22	39	57	20
2	12	24	7	29.17%	17	26	47	57	24
3	4	12	4	33.33%	8	12	22	74	8
3	5	15	5	33.33%	10	15	27	74	10
3	6	18	6	33.33%	12	18	33	74	12
3	7	21	7	33.33%	14	22	39	74	14
3	8	24	7	29.17%	17	26	47	74	16
4	3	12	4	33.33%	8	12	22	101	6
4	4	16	5	31.25%	11	17	30	101	8
4	5	20	6	30.00%	14	22	39	101	10
4	6	24	7	29.17%	17	26	47	101	12
4	7	28	8	28.57%	20	31	56	101	14

CW = Codeword; EC = Error correction

Note 1: Includes a 1X Quiet Zone on each side.

Note 2: Assumes row height = 2X; does not include separator pattern.

5.11.2.2 CC-B structure

CC-B is a MicroPDF417 symbol uniquely identified by the codeword 920 as the first codeword in the symbol. Encoding systems normally automatically select CC-B when the data to be encoded exceeds the capacity of CC-A. CC-B can encode up to 338 digits. It has from 10 to 44 rows and 2 to 4 columns.

Each row is a minimum of 2X high (where X is the width of a module, narrow bar or space). A 1X high minimum separator pattern is positioned between the linear component and 2D Composite Component. (A different separator pattern, 6X high, is used in Composite symbols with EAN/UPC linear components).

Each column contains one $n,k = 17,4$ data or error correction character (codeword) per row (where n is the number of modules and k is the number of bars and also the number of spaces). So the width of a codeword is 17X.

In addition to the codeword columns, CC-B has two or three $n,k = 10,3$ row address pattern (RAP) columns that encode the row numbers (each 10X wide). The rightmost RAP column is terminated on the right by a 1X bar, so it is 11X instead of 10X wide.

Each row also requires a 1X Quiet Zone on each end. There is no Quiet Zone required above CC-B. The separator pattern is printed directly above the linear component and no Quiet Zone is required below the CC-B.

The two-column CC-B version has two RAP columns and the three- and four-column CC-B versions have three RAP columns, as shown in the figure below.

Figure 5.11.2.2-1. CC-B column structures

Two-column CC-B structure

Quiet Zone	RAP column	Codeword column	Codeword column	RAP column	Quiet Zone
------------	------------	-----------------	-----------------	------------	------------

Three-column CC-B structure

Quiet Zone	RAP column	Codeword column	RAP column	Codeword column	Codeword column	RAP column	Quiet Zone
------------	------------	-----------------	------------	-----------------	-----------------	------------	------------

Four-column CC-B structure

Quiet Zone	RAP column	Codeword column	Codeword column	RAP column	Codeword column	Codeword column	RAP column	Quiet Zone
------------	------------	-----------------	-----------------	------------	-----------------	-----------------	------------	------------

CC-B differs from CC-A in the three-column structure in that CC-B has a third RAP column on the left end that is missing in CC-A.

Figure 5.11.2.2-2 lists all the possible column and row combinations for CC-B. It also shows the capacity and size of the 2D Composite Components. For example, a four-column, 10-row CC-B would be 101X wide by 20X high (not including the separator pattern). With an X-dimension of 0.254 millimetre (0.0100 inch), it would be 25.65 millimetres (1.010 inches) wide by 5.08 millimetres (0.200 inch) high.

Figure 5.11.2.2-2. CC-B row and column sizes

Number of data columns (c)	Number of rows (r)	Total CWs in data region	Number of EC CWs (k)	Percent of CWs for EC	Number of non-EC CWs	Number of CWs for data (note 1)	Max alpha chars	Max digits	CC-B width, in X (see note 2)	CC-B height, in X (see note 3)
2	17	34	10	29	24	22	34	59	57	34
2	20	40	11	28	29	27	42	73	57	40
2	23	46	13	28	33	31	48	84	57	46
2	26	52	15	29	37	35	55	96	57	52
3	15	45	21	47	24	22	34	59	84	30
3	20	60	26	43	34	32	50	86	84	40
3	26	78	32	41	46	44	68	118	84	52
3	32	96	38	40	58	56	88	153	84	64
3	38	114	44	39	70	68	107	185	84	76
3	44	132	50	38	82	80	127	219	84	88
4	10	40	16	40	24	22	34	59	101	20
4	12	48	18	38	30	28	43	75	101	24
4	15	60	21	35	39	37	58	100	101	30
4	20	80	26	33	54	52	82	141	101	40
4	26	104	32	31	72	70	111	192	101	52
4	32	128	38	30	90	88	139	240	101	64
4	38	152	44	29	108	106	168	290	101	76
4	44	176	50	28	126	124	196	338	101	88

CW = Codeword; EC = Error correction
 Note 1: Excludes EC codewords and 2 codewords to define CC-B encodation.
 Note 2: Including 1X Quiet Zones on either side.
 Note 3: Assumes $Y = 2X$; does not include separator pattern.

5.11.2.3 CC-C structure

CC-C is a PDF417 symbol uniquely identified by the codeword 920 as the first codeword in the symbol following the symbol length descriptor. CC-C is only used as a 2D Composite Component within a GS1-128 Composite symbol. It has the greatest data capacity of the Composite symbols, encoding up to 2,361 digits. It has from 3 to 30 rows and 1 to 30 data/EC codeword columns.

Each row is a minimum of 3X high (where X is the width of a module, narrow bar, or space). A 1X high minimum separator pattern is positioned between the linear component and 2D Composite Component.

Each column contains one $n, k = 17, 4$ data or error correction character (codeword) per row (where n is the number of modules and k is the number of bars and also the number of spaces). So the width of a data/EC codeword is 17X.

In addition to the codeword columns, CC-C has two 17,4 row indicator columns, a 17X wide start pattern and a 18X wide stop pattern as illustrated in figure [5.11.2.3-1](#).

Each row also requires a 2X Quiet Zone on each end. There is no Quiet Zone required above CC-C. The separator pattern is printed directly above the linear component and no Quiet Zone is required below the CC-C.

Figure 5.11.2.3-1. CC-C row structure

Quiet Zone	Start pattern	Left row indicator column	1 to 30 Data/EC codeword columns	Right row indicator column	Stop pattern	Quiet Zone
------------	---------------	---------------------------	----------------------------------	----------------------------	--------------	------------

CC-C is normally printed with the number of columns that will result in a width nearly matching the width of the GS1-128 symbol linear component. However, as an option, the user may specify a wider CC-C to be printed. This reduces the height of the 2D Composite Component. A lower Composite symbol may be needed to fit in a height-restricted application. A wider CC-C may also be required if the amount of data does not fit in the default width CC-C.

5.11.2.4 Special compressed element string sequences

While 2D Composite Components can encode any sequence of GS1 Application Identifier (AI) element strings up to the maximum capacity of the component, certain sequences of AI element strings have been selected for special compression in 2D Composite Component symbols. If the application requires the use of the AI element strings in one of these sequences, and they are used in the predefined sequence, a smaller symbol will result.

For special compression to be performed, the AI element string sequence must occur at the start of the 2D Composite Component's data. Other AI element strings may be added following the sequence. The AI element strings selected for special compression are:

- Production date and lot number: AI (11) production date followed by AI (10) lot number.
- Expiration date and lot number: AI (17) expiration date followed by AI (10) lot number.
- AI (90): AI (90) followed by the element string data starting with an alphabetic character and a digit; AI (90) may be used to encode data identifier data; the AI (90) followed by data in the data identifier format has special compression applied only if it is the start of the first element string.

5.11.3 Human readable interpretation of Composite symbols

For human readable interpretation rules see section [4.14](#). For HRI rules specific to regulated healthcare retail consumer trade items, see section [4.14.1](#).

5.11.4 Data transmission and symbology identifier prefixes

5.11.4.1 Default transmission mode

The GS1 system requires the use of symbology identifiers. Composite symbols are normally transmitted using symbology identifier prefix **je0**, with the data from the 2D Composite Component directly appended to that of the linear component. For example, a Composite symbol encoding (01)10012345678902(10)ABC123 produces the data string "je0011001234567890210ABC123" (note that the symbology identifier prefix **je0** is different from the symbology identifier prefix **JE0**, which has an uppercase "E" and is used for standard EAN/UPC symbols). However, readers have an option to transmit only the linear component data and ignore the 2D Composite Component.

Data transmission follows the same principles that apply to the concatenation of GS1 Application Identifier (AI) element strings from GS1-128 symbols. If the linear component data ends with a variable length AI element string, the control character <GS> (ASCII value 29 (decimal), 1D (hexadecimal)) is inserted between it and the first character of the data from the 2D Composite Component.

5.11.4.2 GS1-128 Symbol transmission mode

Readers also have an option for GS1-128 symbol emulation mode. This mode emulates the GS1-128 symbology for data transmission. It can be used for applications programmed for GS1-128 symbols but not yet programmed to recognise the symbology identifier prefix **je0**. The symbology identifier for GS1-128 symbol emulation mode is **jc1**. Composite symbols that exceed 48 data characters are transmitted as two or more messages so as not to exceed the maximum GS1-128 symbol message length. Each of the messages has a symbology identifier prefix of **jc1** and does not exceed 48 data characters. The messages are split at boundaries between element strings. This mode is inferior to the normal transmission mode as message integrity may be lost when a message is split into multiple messages.

✔ **Note:** When GS1-128 emulation option is enabled in the reader, each data packet (except the data from an EAN/UPC component) SHALL be prefixed with a symbology identifier of **jc1**. When transmitting data from GS1 Composite symbols, two separate transmissions from the reader are required. The data from the EAN/UPC component is prefixed with a symbology identifier in accordance with symbology identifier "E". Modifier character values 1 and 2 SHALL NOT be used when transmitting data from GS1 DataBar symbols.

5.11.4.3 Symbol separator character

The 2D Composite Component can encode symbol separator characters as defined in the decoder. This character instructs the reader to terminate the current Composite symbol's data message and transmit the data following the symbol separator as a separate message. This new message will have the symbology identifier prefix of **je1**. This feature will be used for future GS1 system applications such as encoding the mixed contents of a logistical container.

5.11.4.4 2D Composite Component escape mechanism

The CC-B and CC-C also can encode 2D Composite Component escape mechanism codewords. These instruct the reader to terminate the current Composite symbol's data message and transmit the data following the escape mechanism codeword as a separate message. This new message has the symbology identifier prefix of **je2** for standard data message. The codewords following the escape mechanism codeword are encoded and decoded using the standard PDF417 encoding defined in *ISO/IEC 15438 – Information technology; automatic identification and data capture techniques – Symbology specification – PDF417*. This feature is used for future GS1 system applications that require characters beyond the *ISO/IEC 646* character subset defined for GS1 Application Identifier (AI) element string data (see figure [7.11-1](#)).

✔ **Note:** The protocol for **je2** corresponds to the protocol defined for PDF417 using symbology identifier **jl2**.

5.11.5 Width of a module (X)

The X-dimension of the 2D Composite Component must be the same as that of the associated linear component. Refer to the linear component's X-dimension requirements.

5.11.6 Print quality

The print quality assessment methodology defined in the International Standard *ISO/IEC 15416* is used for measuring and grading the linear components. The ISO print quality specification is functionally identical to the older ANSI and CEN print quality specifications. The print quality grade is measured by verifiers that apply the standard. The print quality grade reported includes a grade level, measuring aperture and the wavelength of light used for the measurement.

AIM ITS 99-002 – International Symbology Specification - MicroPDF417 and *ISO/IEC 15438* specify the methods for determining the print quality grade of the 2D Composite Components CC-A/B and CC-C respectively. An additional grading parameter unused error correction (UEC) is defined in these specifications.

The minimum quality grade for Composite symbols is:

1.5 / 6 / 660

- Where-

- 1.5 is the overall symbol quality grade.
- 6 is the measuring aperture reference number (corresponding to a 0.15 millimetre or 0.006 inch diameter aperture).
- 660 is the peak response wavelength in nanometres. In addition to the print quality grade, all elements in the separator patterns SHOULD be visually distinguishable.

Both the linear component and the 2D Composite Component must independently achieve the minimum print quality grade.

5.11.7 Advice for selecting a symbology

Any use of the 2D Composite Component SHALL comply with GS1 system global application standards and multiple barcode management practices (see section [4.15](#)). The linear component of a Composite symbol should be selected according to the application rules defined in these *GS1 General Specifications*, but where a choice of linear components is available for the application, consideration should also be given to the 2D Composite Component options available. A wider linear component will result in a shorter 2D Composite Component and, particularly for CC-B, a higher capacity symbol.

For CC-A and CC-B, the selection of the linear component automatically determines the number of columns of the 2D Composite Component. The selection of CC-A or CC-B is automatically determined by the amount of data to be encoded. CC-A is always used unless the data exceeds its capacity.

When the linear component is a GS1-128 symbol, the user may specify CC-A/B or CC-C. CC-A/B will produce a smaller 2D Composite Component. However, CC-C can increase in width to match the width of the GS1-128 symbol or be selected to be even wider. This may produce a Composite symbol of lower height. CC-C also has a larger data capacity, so it is suitable for applications such as logistics.

5.11.8 Sample Composite symbols

Figure 5.11.8-1. EAN-13 symbol with a four-column CC-A component



Figure 5.11.8-2. UPC-A symbol with a four-column CC-B component



Figure 5.11.8-3. EAN-8 symbol with a three-column CC-A



Figure 5.11.8-4. UPC-E symbol with a two-column CC-A



Figure 5.11.8-5. GS1 DataBar Omnidirectional symbol with a four-column CC-A



(01)03612345678904(11)990102

Figure 5.11.8-6. GS1 DataBar Stacked symbol with a two-column CC-A



(01)03412345678900(17)010200

Figure 5.11.8-7. GS1 DataBar Limited symbol with a three-column CC-B



(01)03512345678907



Note: The three-column CC-B is wider than the three-column CC-A shown in figure [5.11.2-1](#).

Figure 5.11.8-8. GS1 DataBar Expanded symbol with a four-column CC-A



(01)93712345678904(3103)001234

(91)1A2B3C4D5E

Figure 5.11.8-9. GS1-128 symbol with a four-column CC-A



(01)03212345678906

(21)A1B2C3D4E5F6G7H8

5.12 Barcode production and quality assessment

5.12.1 Introduction

This section has been evolving to meet the changes to data carriers and their use within the GS1 system. Some of those changes are, for example, dimension requirements, the introduction of new symbols (e.g., GS1 DataBar and Composite Component) and the shift from the use of analogue film masters to digital barcode files.

Consideration should be given to how these changes affect barcode production and the maintenance of quality in the production process.

5.12.2 Dimensional specifications and operational requirements

Over the years, operational requirements of GS1 system users have influenced the dimensional specifications of GS1 system symbols and these dimensional specifications have in turn influenced the development of scanning system optics and printing processes. The dimensional requirements for each application area defined in section 2 are set out in the GS1 symbol specification tables (SSTs) (see section [5.12.3](#)). Each SST provides the following barcode specification detail:

- The barcode(s) specified by the GS1 system for each application area.
 - The minimum, target and maximum X-dimension (narrow element width) for the symbol, based on the scanning environment. Please note that a smaller X-dimension may result in a lower scanning performance.
 - The minimum and target barcode height, based on the scanning environment. Please note that reducing the symbol height may result in a lower scanning performance.
 - The Quiet Zone width and, for main and supplemental symbols, the minimum and maximum separation between the two symbols. (These measurements are expressed as multiples of the X-dimension in the form nX .)
 - The minimum ISO quality specification expressed as **g.g/aa/www**, where **g.g** is the minimum overall symbol grade to one decimal place (on a 4.0 scale), **aa** is the effective measuring aperture in thousandths of an inch and **www** is the wavelength of the light source in nanometres.
- ✔ **Note:** Please refer to section 2 for any specific application standard (such as section [2.1.6](#), *Healthcare secondary packaging* and section [2.6.14](#), *Permanently marked items*) that may supplement or supersede these symbol specification tables for specific application areas.

Before determining the exact symbol specification required, additional factors, such as the scanning environment, SHALL be considered. These are summarised in section [5.12.2.1](#).

5.12.2.1 Role of the symbol's dimensional specifications

The four major dimensional specifications are the symbol's minimum, target and maximum X-dimensions and the symbol's minimum bar height. These dimensional characteristics are always specified for a particular operating environment. The minimum and maximum X-dimensions are determined by the scanner's operating range (field of view). The target X-dimension is the ideal size for a particular application and is only affected by the choice between linear or two-dimensional symbols (when the application allows for both symbol types). The barcode's height is determined by the ergonomic aspects of product handling when using a scanner. These dimensional specifications are critical for the efficient use of all scanners.

5.12.2.2 Omnidirectional scanning and the term magnification

The EAN/UPC symbology was originally designed for omnidirectional scanners. For this type of scanner, the specifications define a fixed relationship between the symbol's width and height. The term "fixed aspect ratio" is used to refer to this fixed proportion. For example, an EAN-13 symbol with an X-dimension of 0.330 mm (0.0130 inch), its nominal dimension, has a width of 37.29 mm (1.468 inch) and a bar height of 22.85 mm (0.900 inch). The term magnification has been used to refer to a range of sizes below, at, or above the nominal dimension (100% magnification) for EAN/UPC symbols used in the omnidirectional scanning environment. The symbol specification tables (SSTs) do not use magnification values and instead list the target, minimum and maximum values for the symbol's X-dimension and height.

5.12.2.3 Laser versus image-based scanning

Most scanners based on laser technology can scan all linear symbologies in the GS1 system. New laser and linear array scanners are even capable of scanning GS1 DataBar and Composite Component symbols. 2D Imaging technology, such as array scanners and vision systems, are capable of scanning all symbols in the GS1 system, including GS1 conformant 2D barcodes (GS1 DataMatrix, GS1 QR Code, GS1 DotCode, QR Code (GS1 Digital Link URI) and Data Matrix (GS1

Digital Link URI)). Note that linear imagers, like laser scanners, cannot scan 2D barcodes; only 2D or array imaging scanners can scan GS1 conformant 2D barcodes, as well as camera based or vision systems.

5.12.2.4 Printing considerations

The functional and operative bands provide printers and labellers with the flexibility needed to produce quality symbols over a wide range of processes. Once a scanning operational environment is determined and the allowable specification range is known, the printer should be consulted for guidance on:

- The minimum recommended symbol size based on printing press or print characterisation tests.
- Colour/substrate considerations (e.g., separate print station for symbol or double ink layer).
- The optimum orientation of the symbol on the printed web (the direction of movement of the media in relation to a printing plate on a printing press).
- Direct part marking, such as is done by dot peening on items, requires special considerations for material properties.
- Laser or chemically etched parts with low contrast or light marked elements on a dark background (e.g., circuit boards and electronic components, medical instruments, surgical implants).
- High-speed ink jet printed parts and components where the marked dots cannot form a scannable linear symbol.
- Very small items that require a symbology with a square aspect ratio and/or cannot be marked within the allocated packaging space by existing GS1 DataBar and Composite symbols.

5.12.2.5 Packaging considerations

Once a scanning operational environment is determined and the allowable symbol characteristics are known, the package designer should be consulted to:

- Ensure the symbol will not be obstructed by other graphics or package design parameters (e.g., folds, creases, corner wraps, flaps, laminates, embossed logos/patterns, text).
- Ensure that only the symbol intended for scanning will be scanned (e.g., obscure all symbols on the individual units within larger trade items so that the individual units' symbols do not scan instead of the larger unit's symbol).

Section [6](#) contains complete information on symbol placement criteria to meet quality and ergonomic needs.

5.12.2.6 GS1 system scanner functional operative bands

Symbol selection and specifications for AIDC application standards are centralised in the symbol specification tables. In establishing X-dimension specifications for symbol specification tables, the scanner functional operative bands below are normative as they illustrate X-dimension ranges deployed by industry based on GS1 standards. The twelve scanner functional bands that have evolved to meet user needs are illustrated in the figure below.

Figure 5.12.2.6-1. GS1 scanner functional operative bands

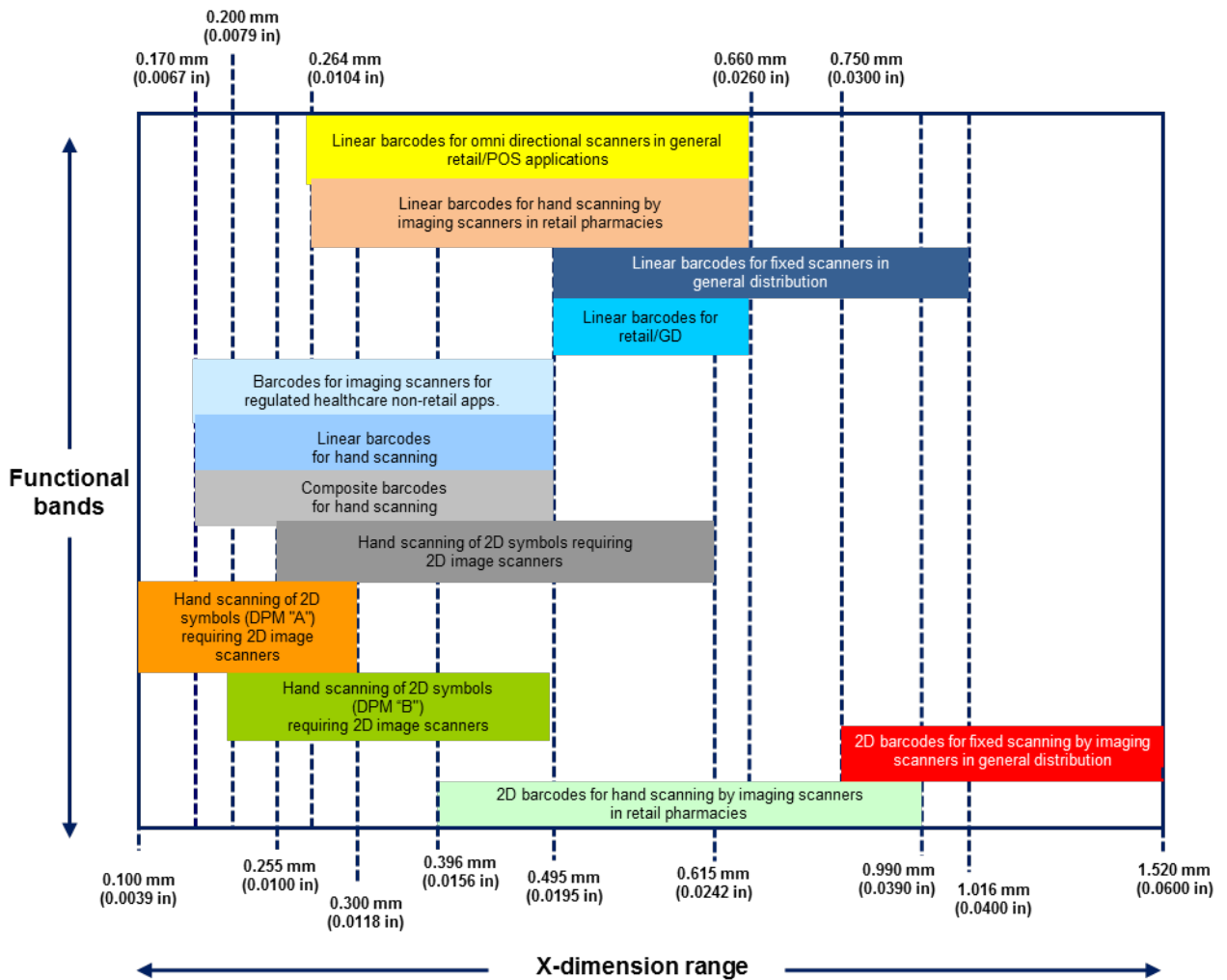

✔ **Note:** Figure not to scale and target size for each functional band can be found in the symbol specification tables (see section [5.12.3](#))

The scanner functional bands

- The omnidirectional scanners for general retail/POS band is primarily intended for general retail consumer trade items to provide orientation-free scanning in high-volume check-out lanes. Scanners are designed to read over-square symbols such as EAN/UPC and GS1 DataBar Retail POS family. The approximate average distance between scanner and symbol is 100 millimetres (4 inches).
- The linear barcodes for imaging scanners for retail pharmacies band is intended for regulated healthcare consumer trade items sold in a pharmacy or apothecary that is a separate retail store or a “controlled” area for distribution of healthcare trade items inside a larger retail operation. This band allows for the use of 2D barcodes but this functional band shows the X-dimension ranges used for linear barcodes. Over the counter trade items that are sold in retail pharmacy but also general retail are marked according to general retail scanning specifications.
- The fixed scanners in general distribution band is primarily intended to facilitate automated scanning of trade items packaged for transport and logistic units using fixed mount scanners. In this environment it is essential to maintain symbol height and location to achieve acceptable scan rates.

- Linear barcodes for both retail and general distribution band covers trade items in specific packaging suitable for transport purposes in general distribution scanning, but that are also scanned as general retail consumer trade items. See the overlap area between EAN/UPC retail and general distribution (Retail/GD) in figure [5.12.2.6-1](#).
- The imaging scanners for non-retail regulated healthcare trade items band is intended for non-retail regulated healthcare consumer trade items sold outside of the retail channel. For example these X-dimension bands should be used for products destined for hospitals or nursing homes that will never be scanned in a retail pharmacy.
- The linear barcodes for hand scanning band is intended for non-retail trade items using a linear barcode.
- The Composite Component barcodes for hand scanning band is intended for non-retail trade items using Composite Component barcodes which are, in effect, a multi-row 2D linear barcode. In general, the rule is that Composite Components SHALL be printed at the same X-dimension as their linear host. GS1 DataMatrix symbols SHALL be printed at X-dimensions that are 50 percent greater than corresponding linear symbols with Composite Components. Therefore, the bands for linear symbols and Composite Components are very similar in X-dimension and if the same scanner types are chosen, as in the case of Composite symbols, the bands become one.
- The 2D barcodes for automated scanning by imaging scanners in general distribution band has been added to show the X-dimension band used by those who support general distribution of regulated healthcare consumer trade items which may be marked with GS1 DataMatrix.
- 2D barcodes for imaging scanners for retail pharmacy band is intended for regulated healthcare consumer trade items sold in a pharmacy or apothecary that is a separate retail store or a "controlled" area for distribution of healthcare trade items inside a larger retail operation. This band allows for the use of linear symbols but this functional band shows the X-dimension ranges used for 2D barcodes. Over the counter trade items that are sold in retail pharmacy but also general retail are marked according to general retail scanning specifications.
- Today, there is no functional band for mobile devices as the variables of symbol selection, data, operative scanning environment and allowable symbol specifications for size would require a detailed table solely for mobile devices. At this time, the assumption for mobile devices is that they will support all currently approved symbols, symbol data scenarios and symbol size specifications however where testing and/or practical experience shows a constraint, this will be addressed in GS1 standards.

Figure 5.12.2.6-2. GS1 symbology operational environment decision tree

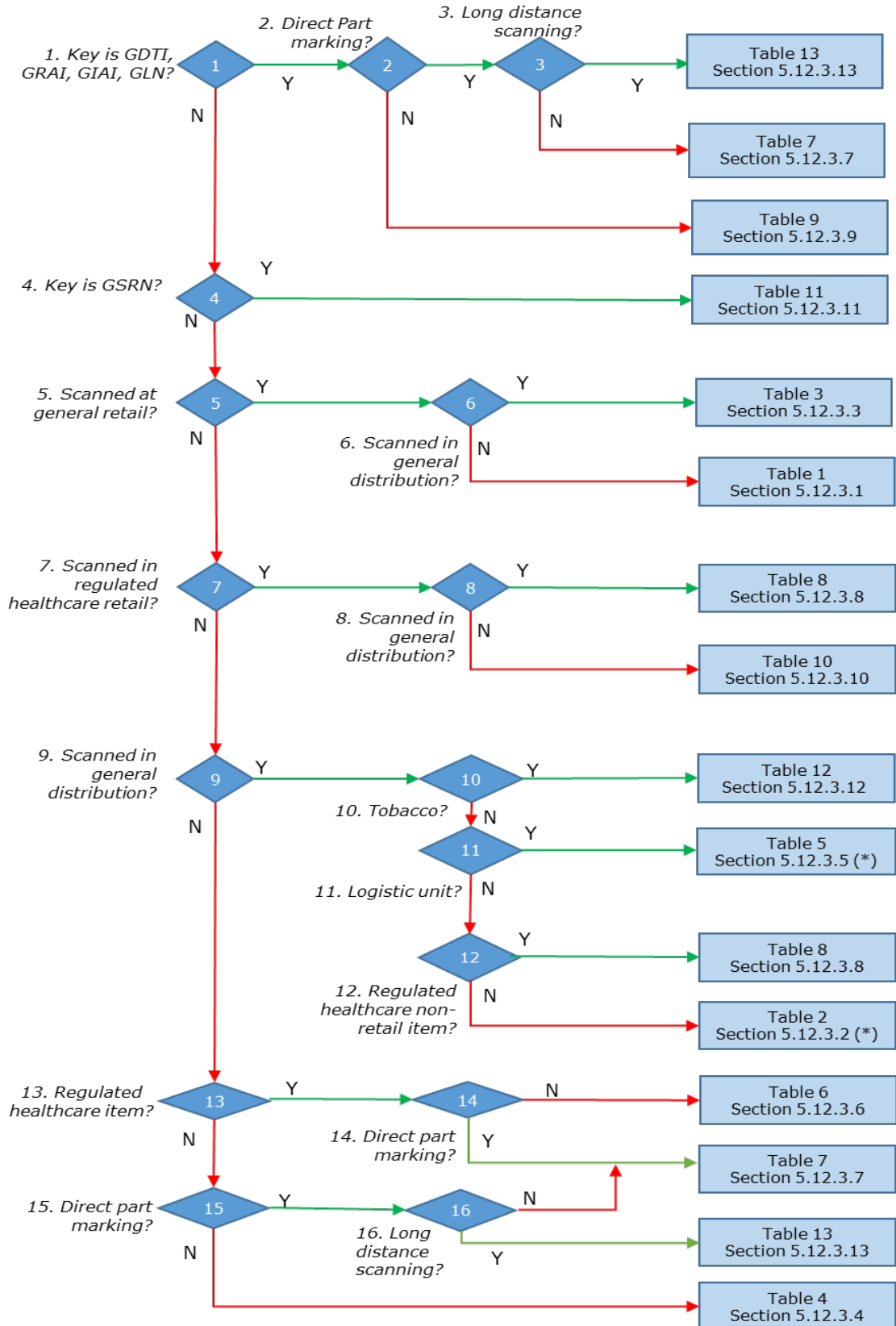

Note: If an item is a general retail consumer trade item and regulated healthcare retail consumer trade item then the barcode marking for general retail is required at a minimum.

Figure 5.12.2.6-3. Summary of the symbol specification tables per following figure [5.12.2.6-2](#) GS1 symbology operational environment decision tree

Symbol spec. tables	General retail POS	Retail pharmacy	* Non-retail pharmacy	Non-retail Non-healthcare	General distribution	Direct part marking	Durable labelling and marking	Logistics unit (SSCC)	GIAI, GRAI, GLN	GSRN
Table 1	Yes									
Table 2				Yes	Yes					
Table 3	Yes				Yes					
Table 4				Yes			Yes			
Table 5					Yes			Yes		
Table 6			Yes							
Table 7			Yes	Yes		Yes				
Table 8		Yes	Yes		Yes					
Table 9							Yes		Yes	
Table 10		Yes								
Table 11										Yes
Table 12					Yes					
Table 13							Yes		Yes	
* Table 6 SHOULD be used for products scanned at bedside										

5.12.3 GS1 symbol specification tables

In order to find the correct barcode specification, you must:

- Find the appropriate GS1 system application area using figure [5.12.2.6-1](#).
- If the application area references two symbol specification tables, use the decision tree in figure [5.12.2.6-2](#) to determine which one to use.

The figure below provides a quick reference list of the symbol quality parameters depending on their type and their application.

Figure 5.12.3-1. Quick reference on symbol quality

Symbology	Application or ID key	ISO (ANSI) symbol grade	Aperture	Wavelength
EAN/UPC	GTIN-8	1.5 (C)	See symbol specification tables 1, 2, 3, 4, 6, 8 and 10 for values	660 nm +/-10
EAN/UPC	GTIN-12	1.5 (C)	See symbol specification tables 1, 2, 3, 4, 6, 8 and 10 for values	660 nm +/-10
EAN/UPC	GTIN-13	1.5 (C)	See symbol specification tables 1, 2, 3, 4, 6, 8 and 10 for values	660 nm +/-10
GS1-128	GTIN-12, GTIN-13, GTIN-14	1.5 (C)	See symbol specification tables 2, 4, 5, 6, 8, 9 and 10 for values	660 nm +/-10
GS1-128	SSCC	1.5 (C)	10 mils	660 nm +/-10
ITF-14 (<0.635 mm (0.025 in.) X)	GTIN-12, GTIN-13, GTIN-14	1.5 (C)	See symbol specification tables 2, 4, 6, 8 and 10 for values	660 nm +/-10
ITF-14 (≥0.635 mm (0.025 in.) X)	GTIN-12, GTIN-13, GTIN-14	0.5 (D)	20 mils	660 nm +/-10
Composite	GTIN-8, GTIN-12, GTIN-13, GTIN-14 and other AIs	1.5 (C)	6 mils	660 nm +/-10
GS1 DataBar	GTIN-8, GTIN-12, GTIN-13, GTIN-14 and other AIs	1.5 (C)	See symbol specification tables 1, 2, 3, 4, 6, 8, 10 and 11	660 nm +/-10
GS1 DataMatrix	Direct part marking, regulated healthcare retail or non-retail consumer trade items, extended packaging and logistic units	1.5 (C)	See symbol specification tables 5, 6, 7, 8, 9, 10 and 11 Table 1 Addendum 1 for AI (8200) for values.	660 nm +/-10
GS1 QR Code	Direct part marking, custom trade item, extended packaging, GDTI, logistic units and GSRN	1.5 (C)	See symbol specification tables 1 Addendum 1 for AI (8200), 5, 7, 9 and 11 for values.	660 nm +/-10
GS1-128, GS1 DataMatrix, GS1 QR Code, GS1 DotCode	Supporting European Regulation 2018/574 on technical standards for the establishment and operation of a traceability system for tobacco products	3.5 (A)	See symbol specification tables 12	660 nm +/- 10
Data Matrix	GS1 Digital Link Standard URI syntax for extended packaging applications	1.5 (C)	See symbol specification table 1 Addendum 2 for GS1 Digital Link for values	660 nm +/- 10



Symbology	Application or ID key	ISO (ANSI) symbol grade	Aperture	Wavelength
QR Code	GS1 Digital Link Standard URI syntax for extended packaging applications	1.5 (C)	See symbol specification table 1 Addendum 2 for GS1 Digital Link for values	660 nm +/- 10



5.12.3.1 Symbol specification table 1 - Trade items scanned in general retail POS and not general distribution

Figure 5.12.3.1-1. GS1 symbol specification table 1

Main symbol(s) specified	X-dimension mm (inches)			(**) Minimum symbol height for given X mm (inches)			Quiet Zone		Minimum quality specification
	(*) Minimum	Target	Maximum	For minimum X-dimension	For target X-dimension	For maximum X-dimension	Left	Right	
EAN-13	0.264 (0.0104")	0.330 (0.0130")	0.660 (0.0260")	18.28 (0.720")	22.85 (0.900")	45.70 (1.800")	11X	7X	1.5/06/660
EAN-8	0.264 (0.0104")	0.330 (0.0130")	0.660 (0.0260")	14.58 (0.574")	18.23 (0.718")	36.46 (1.435")	7X	7X	1.5/06/660
UPC-A	0.264 (0.0104")	0.330 (0.0130")	0.660 (0.0260")	18.28 (0.720")	22.85 (0.900")	45.70 (1.800")	9X	9X	1.5/06/660
UPC-E	0.264 (0.0104")	0.330 (0.0130")	0.660 (0.0260")	18.28 (0.720")	22.85 (0.900")	45.70 (1.800")	9X	7X	1.5/06/660
GS1 DataBar Omni-directional (****)	0.264 (0.0104")	0.330 (0.0130")	0.660 (0.0260")	12.14 (0.478")	15.19 (0.598")	30.36 (1.195")	None	None	1.5/06/660
GS1 DataBar Stacked Omni-directional (***) (****)	0.264 (0.0104")	0.330 (0.0130")	0.660 (0.0260")	25.10 (0.988")	31.37 (1.235")	62.70 (2.469")	None	None	1.5/06/660
GS1 DataBar Expanded	0.264 (0.0104")	0.330 (0.0130")	0.660 (0.0260")	8.99 (0.354")	11.23 (0.442")	22.44 (0.883")	None	None	1.5/06/660
GS1 DataBar Expanded Stacked (****)	0.264 (0.0104")	0.330 (0.0130")	0.660 (0.0260")	18.75 (0.738")	23.44 (0.923")	46.86 (1.845")	None	None	1.5/06/660

Main symbol(s) Specified Plus Add-on 2 or 5	X-dimension mm (inches)			(**) Minimum symbol height for given X mm (inches)			Quiet Zone	Min separation between symbols	Max separation between symbols	Quiet Zone	Min. Quality Spec.
	(*) Minimum	Target	Maximum	For min. X-dimension	For target X-dimension	For max. X-dimension					
EAN-13 + 2	0.264 (0.0104")	0.330 (0.0130")	0.660 (0.0260")	18.28 (0.720")	22.85 (0.900")	45.70 (1.800")	11X	7X	12X	5X	1.5/06/ 660
EAN-13 + 5	0.264 (0.0104")	0.330 (0.0130")	0.660 (0.0260")	18.28 (0.720")	22.85 (0.900")	45.70 (1.800")	11X	7X	12X	5X	1.5/06/ 660
UPC-A + 2	0.264 (0.0104")	0.330 (0.0130")	0.660 (0.0260")	18.28 (0.720")	22.85 (0.900")	45.70 (1.800")	9X	9X	12X	5X	1.5/06/ 660
UPC-A + 5	0.264 (0.0104")	0.330 (0.0130")	0.660 (0.0260")	18.28 (0.720")	22.85 (0.900")	45.70 (1.800")	9X	9X	12X	5X	1.5/06/ 660
UPC-E + 2	0.264 (0.0104")	0.330 (0.0130")	0.660 (0.0260")	18.28 (0.720")	22.85 (0.900")	45.70 (1.800")	9X	7X	12X	5X	1.5/06/ 660
UPC-E + 5	0.264 (0.0104")	0.330 (0.0130")	0.660 (0.0260")	18.28 (0.720")	22.85 (0.900")	45.70 (1.800")	9X	7X	12X	5X	1.5/06/ 660

(*)	<p>These barcodes may only be printed using an X-dimension below 0.264 millimetre (0.0104 inch) under the following conditions:</p> <ul style="list-style-type: none"> ■ The allowance for X-dimensions between 0.249 millimetre (0.0098 inch) and 0.264 millimetre (0.0104 inch) is only applicable to on demand (e.g., thermal, laser) print processes. For all other printing processes, an X-dimension of 0.264 millimetre (0.0104 inch) is attainable and is the minimum allowable size. ■ When printing a minimum symbol with any method of printing, the area provided for printing the symbol and the required Quiet Zone SHOULD never be less than the area required for an X-dimension of 0.264 millimetre (0.0104 inch).
(**)	<ul style="list-style-type: none"> ■ The minimum symbol height dimensions listed for all symbologies including EAN/UPC symbols do not include the human readable interpretation. ■ When printing a minimum symbol with any method of printing, the bar height SHALL NOT be truncated below the minimum as listed in the table above. ■ Because of the operative scanning environment for EAN/UPC symbols, there is a direct relationship between the symbol's height and width. This means the minimum symbol height listed is tied to the minimum, target and maximum X-dimension listed. There is no maximum for the height, but if the maximum X-dimension is used, the symbol height must be equal to or greater than those listed in the Minimum Symbol Height column. ■ The minimum heights of EAN/UPC symbols do not include the extended bars: see section 5.2.3.2 for dimensions of the extended bars. ■ For GS1 DataBar Expanded Stacked symbols, the table reflects the minimum symbol height for symbols that are two rows in height.
(***)	<p>In addition to the factors above related to digital printing, one other exception is permitted; For loose produce being weighed at the point-of-sale (POS) using GS1 DataBar Stacked Omnidirectional minimum X-dimension of 0.203 millimetre (0.0080 inch) is permitted but may produce scanning performance reduction. However, for POS, this performance drop off is not noticeable when the product must be weighed at the point-of-sale. Even with a slower scanning performance to conduct the transaction, the weighing process takes longer than the scanning process. For that reason, a lower minimum X-dimension should never be used on products crossing point-of-sale which are not weighed as loose produce during the scan event.</p>
(****)	<p>The current symbol specification for GS1 DataBar Omnidirectional (minimum height 33X) and GS1 DataBar Stacked Omnidirectional (minimum height 69X) indicate a square aspect ratio for the symbol segments. To enhance scanning performance, in an omnidirectional scanning environment, an over square aspect ratio SHALL be used following the example of the EAN/UPC symbology specification and rigorous field test of the GS1 DataBar symbology (46X or 95X).</p>
(*****)	<p>For North American coupon codes using GS1 DataBar Expanded Stacked in 2 row and 3 row configurations the X-dimension may be as low as 0.0080" (0.203mm) as long as a minimum overall bar height of 1.020" (25.91mm) is maintained. X-dimensions less than 0.0100" (.254mm) might not always be feasible for all GS1 DataBar coupon barcodes due to variables, such as printing process, symbol orientation and material. Due to the time sensitive nature of the coupon printing process, these variables should be considered during the design and barcode origination processes. Barcode verification should always be done from printing press proofs.</p>



Note: See section [2.7](#) to ensure the correct symbol specification table is used.

Figure 5.12.3.1-1 is used to determine the appropriate specifications for printing and quality control of the barcode used in the retail point-of-sale for products. In addition to the symbol used at general retail POS, an additional 2D barcode may be used to carry AI (8200). As AI (8200) has a mandatory association with GTIN, the GTIN within the symbol ensures compatibility with direct or indirect mode. GS1 DataMatrix is approved for all applications including regulated healthcare trade items covered by SSTs 6, 7, 8, 10 and 11, but for general retail consumer trade items, GS1 DataMatrix, QR Code with GS1 Digital Link URI and Data Matrix with GS1 Digital Link URI are GS1 conformant options. When using 2D barcodes to carry AI (8200) on general retail trade items, the following specifications are required. For additional barcodes that carry GS1 Digital Link URIs (i.e. QR Code and Data Matrix), see figure 5.12.3.1-3 below.

Figure 5.12.3.1-2. GS1 symbol specification table 1 addendum 1 for AI (8200)

Symbol(s) specified	X-dimension mm (inches)			Minimum symbol height for given X mm (inches)			Quiet Zone Surrounding Symbol	Minimum quality specification
	Minimum	Target	Maximum	For minimum X-dimension	For target X-dimension	For maximum X-dimension		
GS1 DataMatrix (ECC 200) (*)	0.396 (0.0150")	0.495 (0.0195")	0.743 (0.0293")	Height is determined by X-dimension and data that is encoded			1X on all four sides	1.5/12/660
GS1 QR Code (*)	0.396 (0.0150")	0.495 (0.0195")	0.743 (0.0293")	Height is determined by X-dimension and data that is encoded			4X on all four sides	1.5/12/660

(*) 2D X-dimension - Optical effects in the image capture process require that the GS1 DataMatrix and GS1 QR Code symbols be printed at 1.5 times the equivalent X-dimension allowed for linear symbols.

Figure 5.12.3.1-3 provides the size and quality criteria for 2D barcodes used on retail consumer trade items scanned at POS. The use of these barcodes SHALL be in addition to a 1D barcode required for retail POS.



 **Note:** Application Standard Profiles in section 8 provide information on conformance requirements for future use of 2D barcodes at retail POS without a mandatory 1D barcode.

Figure 5.12.3.1-3. Symbol specification table 1 addendum 2 for 2D barcodes

Symbol(s) specified	X-dimension mm (inches)			Minimum symbol height for given X mm (inches)			Quiet Zone Surrounding Symbol	Minimum quality specification
	Minimum	Target	Maximum	For minimum X-dimension	For target X-dimension	For maximum X-dimension		
GS1 DataMatrix (ECC 200) (*)	0.396 (0.0150")	0.495 (0.0195")	0.990 (0.0390")	Height is determined by X-dimension and data that is encoded			1X on all four sides	1.5/12/660
Data Matrix (GS1 Digital Link URI) (ECC 200) (*) (**)	0.396 (0.0150")	0.495 (0.0195")	0.990 (0.0390")	Height is determined by X-dimension and data that is encoded			1X on all four sides	1.5/12/660
QR Code (GS1 Digital Link URI) (*) (**)	0.396 (0.0150")	0.495 (0.0195")	0.990 (0.0390")	Height is determined by X-dimension and data that is encoded			4X on all four sides	1.5/12/660

(*) 2D X-dimension - Optical effects in the image capture process require that the Data Matrix and QR Code symbols be printed at 1.5 times the equivalent X-dimension allowed for linear symbols.

(**) GS1 Digital Link URI syntax SHALL use the uncompressed form.

 **Note:** The dimensional and quality specifications in figure 5.12.3.1-3 reflect the requirements within a read range typical of mobile device scanning of consumer trade item packaging.

Note: For trading partners with the ability to scan and process GTIN encoded in GS1 DataMatrix or GS1 QR Code barcodes for variable measure fresh food trade items, a minimum X-dimension of 0.375 mm (0.0148 inches) is permitted and SHALL be done through mutual agreement.

5.12.3.2 Symbol specification table 2 - Trade items scanned in general distribution only

Figure 5.12.3.2-1. GS1 symbol specification table 2

Symbol(s) specified	(*) X-dimension mm (inches)			(**) Minimum symbol height for given X mm (inches)			Quiet Zone		(***) Minimum quality specification
	Minimum	Target	Maximum	For minimum X-dimension	For target X-dimension	For maximum X-dimension	Left	Right	
EAN-13	0.495 (0.0195")	0.660 (0.0260")	0.660 (0.0260")	34.28 (1.350")	45.70 (1.800")	45.70 (1.800")	11X	7X	1.5/10/660
UPC-A	0.495 (0.0195")	0.660 (0.0260")	0.660 (0.0260")	34.28 (1.350")	45.70 (1.800")	45.70 (1.800")	9X	9X	1.5/10/660
UPC-E	0.495 (0.0195")	0.660 (0.0260")	0.660 (0.0260")	34.28 (1.350")	45.70 (1.800")	45.70 (1.800")	9X	7X	1.5/10/660
ITF-14	0.495 (0.0195")	0.495 (0.0195")	1.016 (0.0400")	31.75 (1.250")	31.75 (1.250")	31.75 (1.250")	10X	10X	1.5/10/660
GS1-128	0.495 (0.0195")	0.495 (0.0195")	1.016 (0.0400")	31.75 (1.250")	31.75 (1.250")	31.75 (1.250")	10X	10X	1.5/10/660
GS1 DataBar Omni-directional	0.495 (0.0195")	0.660 (0.0260")	0.660 (0.0260")	16.34 (0.644")	21.78 (0.858")	21.78 (0.858")	None	None	1.5/10/660
GS1 DataBar Stacked Omni-directional	0.495 (0.0195")	0.660 (0.0260")	0.660 (0.0260")	34.16 (1.346")	45.54 (1.794")	45.54 (1.794")	None	None	1.5/10/660
GS1 DataBar Expanded	0.495 (0.0195")	0.660 (0.0260")	0.660 (0.0260")	16.83 (0.663")	22.44 (0.884")	22.44 (0.884")	None	None	1.5/10/660
GS1 DataBar Expanded Stacked	0.495 (0.0195")	0.660 (0.0260")	0.660 (0.0260")	35.15 (1.385")	46.86 (1.846")	46.86 (1.846")	None	None	1.5/10/660
GS1 DataBar Stacked	0.495 (0.0195")	0.660 (0.0260")	0.660 (0.0260")	6.44 (0.254")	8.58 (0.338")	8.58 (0.338")	None	None	1.5/10/660
GS1 DataBar Limited	0.495 (0.0195")	0.660 (0.0260")	0.660 (0.0260")	4.95 (0.195")	6.60 (0.260")	6.60 (0.260")	None	None	1.5/10/660
GS1 DataBar Truncated	0.495 (0.0195")	0.660 (0.0260")	0.660 (0.0260")	6.44 (0.254")	8.58 (0.338")	8.58 (0.338")	None	None	1.5/10/660
GS1 DataMatrix (ECC 200) (***)	0.743 (0.0292)	0.743 (0.0292")	1.50 (0.0591)	Height is determined by X-dimension and data that is encoded			1X on all four sides		1.5/20/660
GS1 QR Code (***)	0.743 (0.0292)	0.743 (0.0292)	1.50 (0.0591)	Height is determined by X-dimension and data that is encoded			4X on all four sides		1.5/20/660

(*) UPC-E symbols are designed for use on small packages. Whenever space permits, UPC-A, EAN-13, ITF-14, or GS1-128 symbols SHOULD be used in the general distribution scanning environment.

The minimum symbol height dimensions listed for all symbologies including EAN/UPC symbols do not include the human readable interpretation (or bearer bars for ITF-14 symbols). The minimum heights of EAN/UPC symbols do not include the extended bars: see section 5.2.3.2 for dimensions of the extended bars. Because of the operative scanning environment for EAN/UPC symbols, there is a direct relationship between the symbol's height and width. This means the minimum symbol height is tied to the minimum, target and maximum X-dimension listed.

ITF-14 symbols with X-dimensions below 0.635 millimetre (0.0250 inch) SHOULD NOT be printed directly on corrugate with conventional (plate-based) processes. The ITF-14 symbol's bar width ratio target is 2.5:1 and the acceptable range is 2.25:1 to 3:1.

GS1-128 symbols have a maximum symbol length of 165.10 millimetres (6.500 inch), which may impact the maximum achievable X-dimension. For example, a GS1-128 symbol containing an SSCC has a maximum achievable X-dimension for 0.940 millimetre (0.0370 inch).

For GS1-128 and ITF-14, a smaller X-Dimension may be used if there is absolutely no possibility of printing the minimum size barcode because the trade item is physically too small; the X-Dimension SHALL NOT be less

	than 0.250 millimetre (0.0098 inch). For details on barcode production and quality assessment see section 5.12 .
(**)	<p>For GS1-128 and ITF-14 symbols the minimum symbol height for General distribution scanning is always 31.75 millimetres (1.250 inch). The minimum symbol height dimensions relate to the bar heights only (do not include human readable interpretation text or ITF-14 symbol bearer bars).</p> <p>If the trade item is physically too small to accommodate the minimum, for GS1-128 and ITF-14 the minimum height can be reduced to 12.70 millimetres (0.500 inch) or in case of further space constraints to no less than 5.08 millimetres (0.200 inch). For details on barcode production and quality assessment see section 5.12.</p> <p>There is no maximum for the height, but if the maximum X-dimension is used, the symbol height must be equal to or greater than those listed in the Minimum Symbol Height column.</p>
(***)	For ITF-14 symbols printed on labels with off-set, thermal, or laser print with an X-dimension 0.495 millimetre (0.0195 inch), the minimum quality specification is 1.5/10/660. For ITF-14 symbols printed directly on corrugate or labels with an X-dimension greater than or equal to 0.635 millimetre (0.0250 inch), the minimum quality specification is 0.5/20/660.
(****)	2D X-dimension - Optical effects in the image capture process require that the GS1 DataMatrix and GS1 QR Code symbols be printed at 1.5 times the equivalent printing X-dimension allowed for linear symbols.



Note: See section [2.7](#) to ensure the correct symbol specification table is used.

5.12.3.3 Symbol specification table 3 - Trade items scanned at general retail POS and general distribution

Figure 5.12.3.3-1. GS1 symbol specification table 3

Symbol(s) specified	(*) X-dimension mm (inches)			(**) Minimum symbol height for given X mm (inches)			Quiet Zone		Minimum quality specification
	Minimum	Target	Maximum	For minimum X-dimension	For target X-dimension	For maximum X-dimension	Left	Right	
EAN-13	0.495 (0.0195")	0.660 (0.0260")	0.660 (0.0260")	34.28 (1.350")	45.70 (1.800")	45.70 (1.800")	11X	7X	1.5/06/660
EAN-8	0.495 (0.0195")	0.660 (0.0260")	0.660 (0.0260")	27.35 (1.077")	36.46 (1.435")	36.46 (1.435")	7X	7X	1.5/06/660
UPC-A	0.495 (0.0195")	0.660 (0.0260")	0.660 (0.0260")	34.28 (1.350")	45.70 (1.800")	45.70 (1.800")	9X	9X	1.5/06/660
UPC-E	0.495 (0.0195")	0.660 (0.0260")	0.660 (0.0260")	34.28 (1.350")	45.70 (1.800")	45.70 (1.800")	9X	7X	1.5/06/660
GS1 DataBar Omnidirectional (***)	0.495 (0.0195")	0.660 (0.0260")	0.660 (0.0260")	22.77 (0.897")	30.36 (1.196")	30.36 (1.196")	None	None	1.5/06/660
GS1 DataBar Stacked Omnidirectional (***)	0.495 (0.0195")	0.660 (0.0260")	0.660 (0.0260")	47.03 (1.853")	62.70 (2.470")	62.70 (2.470")	None	None	1.5/06/660
GS1 DataBar Expanded	0.495 (0.0195")	0.660 (0.0260")	0.660 (0.0260")	16.83 (0.663")	22.44 (0.884")	22.44 (0.884")	None	None	1.5/06/660
GS1 DataBar Expanded Stacked	0.495 (0.0195")	0.660 (0.0260")	0.660 (0.0260")	35.15 (1.385")	46.86 (1.846")	46.86 (1.846")	None	None	1.5/06/660

(*) UPC-E and EAN-8 symbols are designed for use on small packages. Whenever space permits, UPC-A and EAN-13 symbols SHOULD be used.

(**) The minimum symbol height dimensions listed for all symbologies including EAN/UPC symbols do not include the human readable interpretation. The minimum heights of EAN/UPC symbols do not include the extended bars: see section 5.2.3.2 for dimensions of the extended bars. Because of the operative scanning environment for EAN/UPC symbols, there is a direct relationship between the symbol's height and width. This means the minimum symbol height listed is tied to the minimum, target and maximum X-dimension listed. There is no maximum for the height, but if the maximum X-dimension is used, the symbol height must be equal to or greater than those listed in the Minimum Symbol Height column.

(***) The current symbol specification for GS1 DataBar Omnidirectional (minimum height 33X) and GS1 DataBar Stacked Omnidirectional (minimum height 69X) indicate a square aspect ratio for the symbol segments. To enhance scanning performance, in an omnidirectional scanning environment, an over square aspect ratio SHALL be used following the example of the EAN/UPC symbology specification and rigorous field test of the GS1 DataBar symbology (46X or 95X).

 **Note:** See section 2.7 to ensure the correct symbol specification table is used.

Figure 5.12.3.3-2 provides the size and quality criteria for 2D barcodes used on retail consumer trade items scanned at POS and in general distribution. The use of these barcodes SHALL be in addition to a 1D barcode required for retail POS and general distribution scanning.

 **Note:** Application Standard Profiles in section 8 provide information on conformance requirements for future use of 2D barcodes at retail POS without a mandatory 1D barcode.

Figure 5.12.3.3-2. Symbol specification table 3 addendum 1 for 2D barcodes

Symbol(s) specified	X-dimension mm (inches)			Minimum symbol height for given X mm (inches)			Quiet Zone Surrounding Symbol	Minimum quality specification
	Minimum	Target	Maximum	For minimum X-dimension	For target X-dimension	For maximum X-dimension		
GS1 DataMatrix (ECC 200) (*)	0.743 (0.0292)	0.990 (0.0390")	0.990 (0.0390")	Height is determined by X-dimension and data that is encoded			1X on all four sides	1.5/20/660
Data Matrix (GS1 Digital Link URI) (ECC 200) (*) (**)	0.743 (0.0292)	0.990 (0.0390")	0.990 (0.0390")	Height is determined by X-dimension and data that is encoded			1X on all four sides	1.5/20/660
QR Code (GS1 Digital Link URI) (*) (**)	0.743 (0.0292)	0.990 (0.0390")	0.990 (0.0390")	Height is determined by X-dimension and data that is encoded			4X on all four sides	1.5/20/660
(*)	2D X-dimension - Optical effects in the image capture process require that the Data Matrix and QR Code symbols be printed at 1.5 times the equivalent X-dimension allowed for linear symbols.							
(**)	GS1 Digital Link URI syntax SHALL use the uncompressed form.							



5.12.3.4 Symbol specification table 4 – Trade items not scanned at POS or general retail - also not scanned in general distribution or regulated healthcare (retail or non-retail)

Figure 5.12.3.4-1. GS1 symbol specification table 4

Symbol(s) specified	(*) X-dimension mm (inches)			(**) Minimum symbol height for given X mm (inches)			Quiet Zone		Minimum quality specification
	Minimum	Target	Maximum	For minimum X-dimension	For target X-dimension	For maximum X-dimension	Left	Right	
EAN-13	0.264 (0.0104")	0.330 (0.0130")	0.660 (0.0260")	18.28 (0.720")	22.85 (0.900")	45.70 (1.800")	11X	7X	1.5/06/660
EAN-8	0.264 (0.0104")	0.330 (0.0130")	0.660 (0.0260")	14.58 (0.574")	18.23 (0.718")	36.46 (1.435")	7X	7X	1.5/06/660
UPC-A	0.264 (0.0104")	0.330 (0.0130")	0.660 (0.0260")	18.28 (0.720")	22.85 (0.900")	45.70 (1.800")	9X	9X	1.5/06/660
UPC-E	0.264 (0.0104")	0.330 (0.0130")	0.660 (0.0260")	18.28 (0.720")	22.85 (0.900")	45.70 (1.800")	9X	7X	1.5/06/660
GS1 DataBar Omni-directional	0.264 (0.0104")	0.330 (0.0130")	0.660 (0.0260")	8.71 (0.343")	10.90 (0.429")	21.78 (0.858")	None	None	1.5/06/660
GS1 DataBar Stacked Omni-directional	0.264 (0.0104")	0.330 (0.0130")	0.660 (0.0260")	18.24 (0.718")	27.78 (1.094")	45.54 (1.794")	None	None	1.5/06/660
GS1 DataBar Expanded	0.264 (0.0104")	0.330 (0.0130")	0.660 (0.0260")	8.99 (0.354")	11.23 (0.442")	22.44 (0.883")	None	None	1.5/06/660
GS1 DataBar Expanded Stacked	0.264 (0.0104")	0.330 (0.0130")	0.660 (0.0260")	18.75 (0.738")	23.44 (0.923")	46.86 (1.845")	None	None	1.5/06/660
GS1 DataBar Stacked	0.264 (0.0104")	0.330 (0.0130")	0.660 (0.0260")	3.43 (0.135")	4.29 (0.169")	8.58 (0.338")	None	None	1.5/06/660
GS1 DataBar Limited	0.264 (0.0104")	0.330 (0.0130")	0.660 (0.0260")	2.64 (0.104")	3.30 (0.130")	6.60 (0.260")	None	None	1.5/06/660
GS1 DataBar Truncated	0.264 (0.0104")	0.330 (0.0130")	0.660 (0.0260")	3.43 (0.135")	4.29 (0.169")	8.58 (0.338")	None	None	1.5/06/660
ITF-14	0.250 (0.00984")	0.495 (0.0195")	0.495 (0.0195")	12.70 (0.500")	12.70 (0.500")	12.70 (0.500")	10X	10X	1.5/06/660
GS1- 128	0.250 (0.00984")	0.495 (0.0195")	0.495 (0.0195")	12.70 (0.500")	12.70 (0.500")	12.70 (0.500")	10X	10X	1.5/06/660
GS1 DataMatrix (ECC 200) (***)	0.380 (0.0150")	0.380 (0.0150")	0.495 (0.0195")	Height is determined by X-dimension and data that is encoded			1X on all four sides		1.5/08/660
GS1 QR Code (***)	0.380 (0.0150")	0.380 (0.0150")	0.495 (0.0195")	Height is determined by X-dimension and data that is encoded			4X on all four sides		1.5/08/660

(*) ITF-14 symbols with X-dimensions below 0.635 millimetre (0.0250 inch) SHOULD NOT be printed directly on corrugate with conventional (plate based) processes. The ITF-14 symbol's bar width ratio target is 2.5:1 and the acceptable range is 2.25:1 to 3:1.

Section 5.12.6 gives full details on when barcodes can be printed at less than the minimum X-dimension. In general, barcodes may only be printed using an X-dimension below 0.264 millimetre (0.0104 inch) or 80 percent magnification under the following conditions:

- The allowance for X-dimensions between 0.249 millimetre (0.0098 inch) or 75 percent magnification and 0.264 millimetre (0.0104 inch) or 80 percent magnification is only applicable to on demand (e.g., thermal, laser) print processes. For all other printing processes, an X-dimension of 0.264 millimetre (0.0104 inch) is attainable and is the minimum allowable size.
- When printing a minimum symbol with any method of printing, the area provided for printing the symbol and the required Quiet Zone should never be less than the area required for an X-dimension of 0.264 millimetre (0.0104 inch).
- When printing a minimum symbol with any method of printing, the symbol height SHALL NOT be truncated.

- (**) The minimum symbol height dimensions listed for all symbologies including EAN/UPC symbols do not include the human readable interpretation (or bearer bars for ITF-14 symbols), The minimum heights of EAN/UPC symbols do not include the extended bars: see section [5.2.3.2](#) for dimensions of the extended bars.
- Because of the operative scanning environment for EAN/UPC symbols, there is a direct relationship between the symbol's height and width. This means the minimum symbol height listed is tied to the minimum, target and maximum X-dimension listed.
- The minimum bar height for ITF-14 and GS1-128 symbols in this operative scanning environment is 12.70 millimetres (0.500 inch), but if the package is physically too small to accommodate this rule, further truncation is permitted. In no case SHALL the bar height be less than 5.08 millimetres (0.200 inch).
- There is no maximum for the symbol height, but if the maximum X-dimension is used, the symbol height must be equal to or greater than those listed in the Minimum Symbol Height column.
- Whereas, linear symbol heights are set at a fixed dimension, Composite Components are printed at the same X-dimension as the linear portion of the Composite symbology and the barcode height varies depending on the amount of data, the X-dimension and which linear symbol is used in conjunction with the Composite Component. Note that Composite Components have to be printed with a linear symbol such as GS1 DataBar, GS1-128, UPC-A, or EAN-13. ITF-14 cannot be used with Composite Components.
- (***) 2D X-dimension - Optical effects in the image capture process require that the GS1 DataMatrix and GS1 QR Code symbols be printed at 1.5 times the equivalent printing X-dimension allowed for linear symbols.



Note: See section [2.7](#) to ensure the correct symbol specification table is used.

5.12.3.5 Symbol specification table 5 – logistic units scanned in general distribution

Figure 5.12.3.5-1. GS1 symbol specification table 5

Symbol(s) specified	(*) X-dimension mm (inches)			(**) Minimum symbol height for given X mm (inches)			Quiet Zone		Minimum quality specification
	Minimum	Target	Maximum	For minimum X-dimension	For target X-dimension	For maximum X-dimension	Left	Right	
GS1-128	0.495 (0.0195")	0.495 (0.0195")	0.940 (0.0370")	31.75 (1.250")	31.75 (1.250")	31.75 (1.250")	10X	10X	1.5/10/660
GS1 DataMatrix (ECC 200)	0.743 (0.0292)	0.743 (0.0292")	1.50 (0.0591)	Height is determined by X-dimension and data that is encoded			1X on all four sides		1.5/20/660
GS1 QR Code	0.743 (0.0292)	0.743 (0.0292)	1.50 (0.0591)	Height is determined by X-dimension and data that is encoded			4X on all four sides		1.5/20/660

(*)	<p>If the logistic unit is physically too small to accommodate the minimum X-dimension, the minimum X-dimension is 0.250 millimetre (0.0098 inch). For details on barcode production and quality assessment see section 5.12.</p>
(**)	<p>The minimum symbol height indicated is for bar height only and does not include the human readable interpretation.</p> <p>If the logistic unit is physically too small to accommodate the minimum, the minimum bar height is the greater of 15 percent of the symbol width including Quiet Zones or 12.70 millimetres (0.500 inch). If the package is physically too small to accommodate this rule, further truncation is permitted, but in no case SHALL the bar height be less than 5.08 millimetres (0.200 inch). For details on barcode production and quality assessment see section 5.12.</p> <p>There is no maximum for the height, but if the maximum X-dimension is used, the symbol height must be equal to or greater than those listed in the Minimum Symbol Height column.</p>



Note: See section [2.7](#) to ensure the correct symbol specification table is used.

5.12.3.6 Symbol specification table 6 - Regulated healthcare non-retail consumer trade items not scanned in general distribution

Figure 5.12.3.6-1. GS1 symbol specification table 6

Symbol(s) specified	X-dimension mm (Inches)			Minimum symbol height for given X mm (inches)			Quiet Zone		Minimum quality specification
	Minimum	Target	Maximum	For minimum X-dimension	For target X-dimension	For maximum X-dimension	Left	Right	
GS1-128	0.170 (0.0067")	0.495 (0.0195")	0.495 (0.0195")	12.70 (0.500")	12.70 (0.500")	12.70 (0.500")	10X	10X	1.5/06/660
GS1 DataMatrix (ECC 200)	0.254 (0.0100")	0.380 (0.0150")	0.990 (0.0390")	Height is determined by X-dimension and data that is encoded			1X on all four sides		1.5/08/660
GS1 DataBar Omni-directional	0.170 (0.0067")	0.200 (0.0080")	0.660 (0.0260")	5.61 (0.221")	6.60 (0.260")	21.78 (0.858")	None	None	1.5/06/660
GS1 DataBar Truncated	0.170 (0.0067")	0.200 (0.0080")	0.660 (0.0260")	2.21 (0.087")	2.60 (0.102")	8.58 (0.338")	None	None	1.5/06/660
GS1 DataBar Stacked	0.170 (0.0067")	0.200 (0.0080")	0.660 (0.0260")	2.21 (0.087")	2.60 (0.102")	8.58 (0.338")	None	None	1.5/06/660
GS1 DataBar Stacked Omni-directional	0.170 (0.0067")	0.200 (0.0080")	0.660 (0.0260")	11.73 (0.462")	13.80 (0.543")	45.54 (1.794")	None	None	1.5/06/660
GS1 DataBar Limited	0.170 (0.0067")	0.200 (0.0080")	0.660 (0.0260")	1.70 (0.067")	2.00 (0.079")	6.60 (0.260")	None	None	1.5/06/660
GS1 DataBar Expanded	0.170 (0.0067")	0.200 (0.0080")	0.660 (0.0260")	5.78 (0.228")	6.80 (0.268")	22.44 (0.884")	None	None	1.5/06/660
GS1 DataBar Expanded Stacked	0.170 (0.0067")	0.200 (0.0080")	0.660 (0.0260")	12.07 (0.475")	14.20 (0.559")	46.86 (1.846")	None	None	1.5/06/660
EAN-13	0.170 (0.0067")	0.330 (0.0130")	0.660 (0.0260")	18.28 (0.720")	22.85 (0.900")	45.70 (1.800")	11X	7X	1.5/06/660
EAN-8	0.170 (0.0067")	0.330 (0.0130")	0.660 (0.0260")	14.58 (0.574")	18.23 (0.718")	36.46 (1.435")	7X	7X	1.5/06/660
UPC-A	0.170 (0.0067")	0.330 (0.0130")	0.660 (0.0260")	18.28 (0.720")	22.85 (0.900")	45.70 (1.800")	9X	9X	1.5/06/660
UPC-E	0.170 (0.0067")	0.330 (0.0130")	0.660 (0.0260")	18.28 (0.720")	22.85 (0.900")	45.70 (1.800")	9X	7X	1.5/06/660
ITF-14	0.170 (0.0067")	0.495 (0.0195")	0.495 (0.0195")	12.70 (0.500")	12.70 (0.500")	12.70 (0.500")	10X	10X	1.5/06/660
CC-A	All CCs need to be printed at the same X-dimensions as their linear components, therefore consult the appropriate row and column for the linear symbol to be used.			Height is determined by X-dimension and data that is encoded.			1X	1X	1.5/06/660
CC-B							1X	1X	1.5/06/660
CC-C							2X	2X	1.5/06/660

✔ **Note:** See section [2.7](#) to ensure the correct symbol specification table is used.

✔ **Note:** This table contains several symbol options. All are permitted to promote backward compatibility, but section 2 application standards define which symbols are the preferred options for the future.

5.12.3.7 Symbol specification table 7 - Direct part marking

Figure 5.12.3.7-1. GS1 symbol specification table 7

Symbol(s) specified	X-dimension mm (inches) Note 1 Note 4			Minimum symbol height for given X mm (inches) For minimum, Target and Maximum X-dimension	Quiet Zone	Minimum quality specification	
	Minimum	Target	Maximum				
GS1 DataMatrix	0.254 (0.0100")	0.300 (0.0118")	0.615 (0.0242")	Height is determined by X-dimension and data that is encoded	1X on all four sides	1.5/06/660 Note 3	For direct marking of items other than medical devices
GS1 QR Code	0.254 (0.0100")	0.300 (0.0118")	0.615 (0.0242")	Height is determined by X-dimension and data that is encoded	4X on all four sides	1.5/06/660 Note 3	For direct marking of items other than medical devices
GS1 DataMatrix Ink Based direct part marking	0.254 (0.0100")	0.300 (0.0118")	0.615 (0.0242")	Height is determined by X-dimension and data that is encoded	1X on all four sides	1.5/08/660 Note 3	For direct marking of medical devices such as small medical/surgical instruments
GS1 DataMatrix direct part marking - A Note 2	0.100 (0.0039")	0.200 (0.0079")	0.300 (0.0118")	Height is determined by X-dimension and data that is encoded	1X on all four sides	DPM1.5/04-12/650/(45Q 30Q 30T 30S 90) Note 5	For direct marking of medical devices such as small medical/surgical instruments
GS1 DataMatrix direct part marking - B Note 2	0.200 (0.0079")	0.300 (0.0118")	0.495 (0.0195")	Height is determined by X-dimension and data that is encoded	1X on all four sides	DPM1.5/08-20/650/(45Q 30Q 30T 30S 90) Note 5	For direct marking of small medical/surgical instruments

✔ **Note:** The largest X-dimension in a given range that will allow a symbol with the needed data content to fit within the available marking area should be used to maximise marking and reading performance (depth of field, tolerance to curvature, etc.).

The angle is an additional parameter defining the angle of incidence (relative to the plane of the symbol) of the illumination for direct part marking verification. It SHALL be included in the overall symbol grade when the angle of incidence is other than 45 degrees. Its absence indicates that the angle of incidence is 45 degrees. See ISO/IEC 15415 and ISO/IEC TR 29158 (AIM DPM).

In small instrument marking, mixed marking technologies used within the same scanning environment should be avoided to ensure highest reading performance. Laser etching is recommended for small instrument marking.

✔ **Note 1:** Optical effects in the image capture process require that label based GS1 DataMatrix and GS1 QR Code symbols be printed at approximately 1.5 times the equivalent X-dimension allowed for linear symbols in the same application.

✔ **Note 2:** There are two basic types of non ink based direct part marks, those with "connected modules" in the "L" shaped finder pattern (GS1 DataMatrix direct part marking – A) created by DPM marking technologies such as laser or chemical etching and those with "non connected modules" in the "L" shaped finder pattern (GS1 DataMatrix direct part marking – B) created by DPM marking technologies such as dot peen. Due to the marking technologies and characteristics of reading they each have varied ranges of X-dimensions and different quality criteria recommended and may require different reading equipment. GS1 DataMatrix – A is suggested for marking of medical devices such as small medical/surgical instruments. The Minimum X-dimension of 0.100mm is based upon the specific need for permanence in direct marking of small medical instruments which have

limited marking area available on the instrument with a target useable area of 2.5mm x 2.5mm and a data content of GTIN (AI 01) plus serial number (AI 21).

✔ **Note 3:** The effective aperture for GS1 DataMatrix and GS1 QR Code quality measurements SHOULD be taken at 80 percent of the minimum X-dimension allowed for the application. For direct part marking - A this would equate to an aperture of 3; for direct part marking - B this would equate to an aperture of 6 and for general healthcare label printing, an aperture of 8. See *ISO/IEC 15415* and *ISO/IEC TR 29158*.

✔ **Note 4:** In practical application, where very small symbol sizes are needed, it may be necessary to work with GS1 DataMatrix module X-dimensions smaller than those suggested. Where dimensional restrictions prohibit the application of a full size code, reduced X-dimension AIDC marking is encouraged to facilitate information capture. It should be noted that these practices may limit the symbol effectiveness, including but not limited to:

- the effect of smaller X-dimensions on reading performance,
- the need for, and limited availability of, special scanners/imagers for reading,
- special processes for marking,
- the overall cost considerations.

These smaller X-dimensions should therefore only be used internally or by mutual agreement between trading partners

✔ **Note 5:** Any "GS1 DataMatrix direct part marking - A" mark that meets the grade requirements under the quality techniques specified in *ISO/IEC 15415* is considered acceptable. If the letters "DPM" precede the grade it indicates that the grade was obtained by following *ISO/IEC TR 29158 (AIM DPM)* and not *ISO/IEC 15415*, regardless whether it is GS1 DataMatrix direct part marking of type A or B.

5.12.3.8 Symbol specification table 8 - Trade items scanned in retail pharmacy and general distribution or non-retail pharmacy and general distribution

Figure 5.12.3.8-1. GS1 symbol specification table 8

Symbol(s) specified	X-dimension mm (inches)			Minimum symbol height for given X mm (inches)			Quiet Zone		Minimum quality specification
	Minimum	Target	Maximum	For minimum X-dimension	For target X-dimension	For maximum X-dimension	Left	Right	
GS1- 128	0.495 (0.0195")	0.495 (0.0195")	1.016 (0.0400")	31.75 (1.250")	31.75 (1.250")	31.75 (1.250")	10X	10X	1.5/10/660
GS1 DataMatrix (ECC 200) (*)	0.750 (0.0300")	0.750 (0.0300")	1.520 (0.0600")	Height is determined by X-dimension and data that is encoded			1X on all four sides		1.5/20/660
EAN-13	0.495 (0.0195")	0.660 (0.0260")	0.660 (0.0260")	34.28 (1.350")	45.70 (1.800")	45.70 (1.800")	11X	7X	1.5/10/660
EAN-8	0.495 (0.0195")	0.660 (0.0260")	0.660 (0.0260")	27.35 (1.077")	36.46 (1.435")	36.46 (1.435")	7X	7X	1.5/10/660
UPC-A	0.495 (0.0195")	0.660 (0.0260")	0.660 (0.0260")	34.28 (1.350")	45.70 (1.800")	45.70 (1.800")	9X	9X	1.5/10/660
UPC-E	0.495 (0.0195")	0.660 (0.0260")	0.660 (0.0260")	34.28 (1.350")	45.70 (1.800")	45.70 (1.800")	9X	7X	1.5/10/660
ITF-14	0.495 (0.0195")	0.495 (0.0195")	1.016 (0.0400")	31.75 (1.250")	31.75 (1.250")	31.75 (1.250")	10X	10X	1.5/10/660
GS1 DataBar Omni-directional	0.495 (0.0195")	0.660 (0.0260")	0.660 (0.0260")	16.34 (0.644")	21.78 (0.858")	21.78 (0.858")	None	None	1.5/10/660
GS1 DataBar Truncated	0.495 (0.0195")	0.660 (0.0260")	0.660 (0.0260")	6.44 (0.254")	8.58 (0.338")	8.58 (0.338")	None	None	1.5/10/660
GS1 DataBar Stacked	0.495 (0.0195")	0.660 (0.0260")	0.660 (0.0260")	6.44 (0.254")	8.58 (0.338")	8.58 (0.338")	None	None	1.5/10/660
GS1 DataBar Stacked Omni-directional	0.495 (0.0195")	0.660 (0.0260")	0.660 (0.0260")	34.16 (1.346")	45.54 (1.794")	45.54 (1.794")	None	None	1.5/10/660
GS1 DataBar Limited	0.495 (0.0195")	0.660 (0.0260")	0.660 (0.0260")	4.95 (0.195")	6.60 (0.260")	6.60 (0.260")	None	None	1.5/10/660
GS1 DataBar Expanded	0.495 (0.0195")	0.660 (0.0260")	0.660 (0.0260")	16.83 (0.663")	22.44 (0.884")	22.44 (0.884")	None	None	1.5/10/660
GS1 DataBar Expanded Stacked	0.495 (0.0195")	0.660 (0.0260")	0.660 (0.0260")	35.15 (1.385")	46.86 (1.846")	46.86 (1.846")	None	None	1.5/10/660
CC-A	All CCs need to be printed at the same X- dimensions as their linear components, therefore consult the appropriate row and column for the linear symbol to be used.			Height is determined by X-dimension and data that is encoded.			1X	1X	1.5/10/660
CC-B							1X	1X	1.5/10/660
CC-C							2X	2X	1.5/10/660

(*) 2D X-dimension - Optical effects in the image capture process require that the GS1 DataMatrix and GS1 QR Code symbols be printed at 1.5 times the equivalent printing X-dimension allowed for linear symbols.

- ✔ **Note:** See section [2.7](#) to ensure the correct symbol specification table is used.
- ✔ **Note:** This table contains several symbol options. All are permitted to promote backward compatibility, but section 2 application standards define which symbols are the preferred options for the future.
- ✔ **Note:** Since June 2007 GS1 has recommended all trading partners in the healthcare sector invest exclusively in imaging-based scanners. Now that GS1 DataMatrix has been approved



within the standard, it is important to inform all trading partners of a process within GS1 to establish target deployment dates. Without these dates, brand owners do not have a way to know when to deploy GS1 DataMatrix on their packaging and those needing to invest in scanning equipment may inadvertently purchase equipment that will not support the standards. To see GS1 healthcare's position paper on GS1 DataMatrix adoption, visit <https://www.gs1.org/healthcare>.

5.12.3.9 Symbol specification table 9 - GS1 keys GDTI, GRAI, GIAI and GLN

Figure 5.12.3.9-1. GS1 symbol specification table 9

Symbol(s) specified	X-dimensions mm(inches)			Minimum symbol height for given X mm(inches)			Quiet Zone		Minimum quality specification
	Minimum	Target	Maximum	For minimum X-dimension	For target X-dimension	For maximum X-dimension	Left	Right	
GS1- 128	0.250 (0.0098")	0.250 (0.0098")	0.495 (0.0195")	12.70 (0.500")	12.70 (0.500")	12.70 (0.500")	10X	10X	1.5/06/660
GS1 DataMatrix (ECC 200) (*)	0.380 (0.0150")	0.380 (0.0150")	0.495 (0.0195")	Height is determined by X-dimension and data that is encoded			1X on all four sides		1.5/08/660
GS1 QR Code (*)	0.380 (0.0150")	0.380 (0.0150")	0.495 (0.0195")	Height is determined by X-dimension and data that is encoded			4X on all four sides		1.5/08/660

(*) 2D X-dimension - Optical effects in the image capture process require that the GS1 DataMatrix and GS1 QR Code symbols be printed at 1.5 times the equivalent printing X-dimension allowed for linear symbols.

- 
Note: See section [2.7](#) to ensure the correct symbol specification table is used.
- 
Note: This table contains several symbol options. All are permitted to promote backward compatibility, but section 2 application standards define which symbols are the preferred options for the future.
- 
Note: For location marking, barcodes may be printed at a higher maximum X-dimension: GS1-128 at 1.016 mm (0.0400 inches), GS1 DataMatrix and GS1 QR Code at 1.520 mm (0.0600 inches). See section [2.4.2](#).



5.12.3.10 Symbol specification table 10 – Regulated healthcare retail consumer trade items not scanned in general distribution

Figure 5.12.3.10-1. GS1 symbol specification table 10

Symbol(s) specified	X-dimension mm (inches)			Minimum symbol height for given X mm (inches)			Quiet Zone		Minimum quality specification
	Minimum (*)	Target	Maximum	For minimum X-dimension	For target X-dimension	For maximum X-dimension	Left	Right	
GS1- 128	0.264 (0.0104")	0.330 (0.0130")	0.660 (0.0260")	12.70 (0.500")	12.70 (0.500")	12.70 (0.500")	10X	10X	1.5/06/660
GS1 DataMatrix (ECC 200) (**)	0.396 (0.0156")	0.495 (0.0195")	0.990 (0.0390")	Height is determined by X-dimension and data that is encoded			1X on all four sides		1.5/08/660
GS1 DataBar Omnidirectional	0.264 (0.0104")	0.330 (0.0130")	0.660 (0.0260")	8.71 (0.343")	10.89 (0.429")	21.78 (0.858)	None	None	1.5/06/660
GS1 DataBar Truncated	0.264 (0.0104")	0.330 (0.0130")	0.660 (0.0260")	3.43 (0.135")	4.29 (0.169")	8.58 (0.338")	None	None	1.5/06/660
GS1 DataBar Stacked	0.264 (0.0104")	0.330 (0.0130")	0.660 (0.0260")	3.43 (0.135")	4.29 (0.169")	8.58 (0.338")	None	None	1.5/06/660
GS1 DataBar Stacked Omnidirectional	0.264 (0.0104")	0.330 (0.0130")	0.660 (0.0260")	18.22 (0.718")	27.77 (0.897")	45.54 (1.794")	None	None	1.5/06/660
GS1 DataBar Limited	0.264 (0.0104")	0.330 (0.0130")	0.660 (0.0260")	2.64 (0.104")	3.30 (0.130")	6.60 (0.260")	None	None	1.5/06/660
GS1 DataBar Expanded	0.264 (0.0104")	0.330 (0.0130")	0.660 (0.0260")	8.98 (0.354")	11.22 (0.442")	22.44 (0.883")	None	None	1.5/06/660
GS1 DataBar Expanded Stacked	0.264 (0.0104")	0.330 (0.0130")	0.660 (0.0260")	18.74 (0.738")	23.43 (0.923")	46.86 (1.846")	None	None	1.5/06/660
EAN-13	0.264 (0.0104")	0.330 (0.0130")	0.660 (0.0260")	18.28 (0.720")	22.85 (0.900")	45.70 (1.800")	11X	7X	1.5/06/660
EAN-8	0.264 (0.0104")	0.330 (0.0130")	0.660 (0.0260")	14.58 (0.574")	18.23 (0.718")	36.46 (1.435")	7X	7X	1.5/06/660
UPC-A	0.264 (0.0104")	0.330 (0.0130")	0.660 (0.0260")	18.28 (0.720")	22.85 (0.900")	45.70 (1.800")	9X	9X	1.5/06/660
UPC-E	0.264 (0.0104")	0.330 (0.0130")	0.660 (0.0260")	18.28 (0.720")	22.85 (0.900")	45.70 (1.800")	9X	7X	1.5/06/660
ITF-14	0.264 (0.0104")	0.330 (0.0130")	0.660 (0.0260")	12.70 (0.500")	12.70 (0.500")	12.70 (0.500")	10X	10X	1.5/06/660
CC-A	All CCs need to be printed at the same X- dimensions as their linear components, therefore consult the appropriate row and column for the linear symbol to be used.			Height is determined by X-dimension and data that is encoded.			1X	1X	1.5/06/660
CC-B							1X	1X	1.5/06/660
CC-C							2X	2X	1.5/06/660

- (*) These barcodes may only be printed using an X-dimension below 0.264 millimetre (0.0104 inch) under the following conditions:
- The allowance for X-dimensions between 0.249 millimetre (0.0098 inch) and 0.264 millimetre (0.0104 inch) is only applicable to on demand (e.g., thermal, laser) print processes. For all other printing processes, an X-dimension of 0.264 millimetre (0.0104 inch) is attainable and is the minimum allowable size.
 - When printing a minimum symbol with any method of printing, the area provided for printing the symbol and the required Quiet Zone SHOULD never be less than the area required for an X-dimension of 0.264 millimetre (0.0104 inch).
 - When printing a minimum symbol with any method of printing, the symbol height SHALL NOT be truncated below the minimum.
- (**) 2D X-dimension - Optical effects in the image capture process require that the GS1 DataMatrix and GS1 QR Code symbols be printed at 1.5 times the equivalent printing X-dimension allowed for linear symbols.

- ✔ **Note:** See section [2.7](#) to ensure the correct symbol specification table is used.
- ✔ **Note:** Since June 2007 GS1 has recommended all trading partners in the healthcare sector invest exclusively in imaging-based scanners. Now that GS1 DataMatrix has been approved within the standard, it is important to inform all trading partners of a process within GS1 to establish target deployment dates. Without these dates, brand owners do not have a way to know when to deploy GS1 DataMatrix on their packaging and those needing to invest in scanning equipment may inadvertently purchase equipment that will not support the standards. To see GS1 Healthcare's Position Paper on GS1 DataMatrix adoption, visit <https://www.gs1.org/healthcare>.

5.12.3.11 Symbol specification table 11 – GS1 GSRNs

Figure 5.12.3.11-1. GS1 symbol specification table 11

Symbol(s) specified	X-dimensions mm(inches)			Minimum symbol height for given X mm (inches)			Quiet Zone		Minimum quality specification
	Minimum	Target	Maximum	For minimum X-dimension	For target X-dimension	For maximum X-dimension	Left	Right	
GS1 DataBar Expanded (*)	0.264 (0.0104")	0.330 (0.0130")	0.660 (0.0260")	8.99 (0.354")	11.23 (0.442")	22.44 (0.883")	None	None	1.5/06/660
GS1 DataBar Expanded Stacked (*)	0.264 (0.0104")	0.330 (0.0130")	0.660 (0.0260")	18.75 (0.738")	23.44 (0.923")	46.86 (1.845")	None	None	1.5/06/660
GS1-128	0.170 (0.0067")	0.250 (0.0098")	0.495 (0.0195")	12.70 (0.500")	12.70 (0.500")	12.70 (0.500")	10X	10X	1.5/05/660
GS1 DataMatrix (ECC 200) (**)	0.254 (0.0100")	0.380 (0.0150")	0.495 (0.0195")	Height is determined by X-dimension and data that is encoded			1X on all four sides		1.5/08/660
GS1 QR Code (**)	0.254 (0.0100")	0.380 (0.0150")	0.495 (0.0195")	Height is determined by X-dimension and data that is encoded			4X on all four sides		1.5/08/660

(*) These dimensions refer to the *Symbol Specification Table 1 - Trade items scanned in general retail POS and not general distribution*.
 These barcodes may only be printed using an X-dimension below 0.264 millimetre (0.0104 inch) under the following conditions:

- The allowance for X-dimensions between 0.249 millimetre (0.0098 inch) and 0.264 millimetre (0.0104 inch) is only applicable to on demand (e.g., thermal, laser) print processes. For all other printing processes, an X-dimension of 0.264 millimetre (0.0104 inch) is attainable and is the minimum allowable size.
- When printing a minimum symbol with any method of printing, the area provided for printing the symbol and the required Quiet Zone SHOULD never be less than the area required for an X-dimension of 0.264 millimetre (0.0104 inch).

Furthermore:

- The minimum symbol height dimensions listed for all symbologies do not include the human readable interpretation.
- When printing a minimum symbol with any method of printing, the bar height SHALL NOT be truncated below the minimum as listed in the table above.
- For GS1 DataBar Expanded Stacked symbols, the table reflects the minimum symbol height for symbols that are two rows in height.
- For GS1 DataBar Expanded Stacked in 2 row and 3 row configurations, the X-dimension may be as low as 0.0080" (0.203mm) as long as a minimum overall bar height of 1.020" (25.91mm) is maintained.

(**) 2D X-dimension - Optical effects in the image capture process require that the GS1 DataMatrix and GS1 QR Code symbols be printed at 1.5 times the equivalent printing X-dimension allowed for linear symbols.

 **Note:** See section [2.7](#) to ensure the correct symbol specification table is used.

 **Note:** This table contains several symbol options. All are permitted to promote backward compatibility, but section 2 application standards define which symbols are the preferred options for the future.

5.12.3.12 Symbol specification table 12 – Tobacco trade items and logistics units for European Regulation 2018/574 on technical standards for the establishment and operation of a traceability system for tobacco products

Figure 5.12.3.12-1. GS1 system symbol specification table 12

Symbol(s) specified	(*) X-dimension mm (inches)			(**) Minimum symbol height for given X mm (inches)			Quiet Zone		(***) Minimum quality specification
	Minimum	Target	Maximum	For minimum X-dimension	For target X-dimension	For maximum X-dimension	Left	Right	
Trade Items at EU 2018/574 Unit Pack Level									
GS1 DataMatrix (ECC 200) (*)	0.380 (0.0150")	0.380 (0.0150")	0.990 (0.0390")	Height is determined by X-dimension and data that is encoded			1X on all four sides		3.5/08/660
GS1 QR Code (*) (**)	0.380 (0.0150")	0.380 (0.0150")	0.990 (0.0390")	Height is determined by X-dimension and data that is encoded			4X on all four sides		3.5/08/660
GS1 DotCode (***)	0.380 (0.0150")	0.380 (0.0150")	0.990 (0.0390")	Height is determined by X-dimension and data that is encoded			3X on all four sides		3.5/08/660
Trade Item Groupings (unit pack aggregations per at EU 2018/574)									
GS1 DataMatrix (ECC 200) (*)	0.750 (0.0295")	0.750 (0.0295")	1.520 (0.0600")	Height is determined by X-dimension and data that is encoded			1X on all four sides		3.5/20/660
GS1 QR Code (*) (**)	0.750 (0.0295")	0.750 (0.0295")	1.520 (0.0600")	Height is determined by X-dimension and data that is encoded			4X on all four sides		3.5/20/660
GS1-128 (****)	0.495 (0.0195")	0.495 (0.0195")	1.016 (0.0400")	31.75 (1.250")			10X	10X	3.5/10/660
Logistic units (unit pack aggregations with a transport unit per at EU 2018/574)									
GS1 DataMatrix (ECC 200)	0.750 (0.0295")	0.750 (0.0295")	1.520 (0.0600")	Height is determined by X-dimension and data that is encoded			1X on all four sides		3.5/20/660
GS1 QR Code (*) (**)	0.750 (0.0295")	0.750 (0.0295")	1.520 (0.0600")	Height is determined by X-dimension and data that is encoded			4X on all four sides		3.5/20/660
GS1-128	0.495 (0.0195")	0.495 (0.0195")	0.940 (0.0370")	31.75 (1.250")			10X	10X	3.5/10/660

(*)	2D X-dimension - Optical effects in the image capture process require that the GS1 DataMatrix and GS1 QR Code symbols be printed at 1.5 times the equivalent printing X-dimension allowed for linear symbols.
(**)	an optical device-readable QR Code with a recovery capacity of approximately 30%. Barcodes conforming to ISO/IEC 18004:2015 with the error correction level H shall be presumed to fulfil the requirements set out in this point.
(***)	an optical device-readable DotCode with the error detection and correction equivalent to or higher than those provided with the Reed-Solomon error correction algorithm with the number of check characters (NC) equal to three plus the number of data characters (ND) divided by two ($NC = 3 + ND / 2$).
(****)	The minimum quality grade of 3.5 is per the European Regulation 2018/574. It is noted that this quality grade is significantly higher than the typical 1.5 grade required for other symbols in other GS1 application standards.



Note: See section [2.7](#) to ensure the correct symbol specification table is used.

5.12.3.13 Symbol specification table 13 – Durable labelling and durable marking enabling long distance scanning

Figure 5.12.3.13-1. GS1 symbol specification table 13

Symbol(s) specified	(*) X-dimension mm (inches)		Minimum symbol height for given X mm (inches)	Quiet Zone		Minimum quality specification
	Minimum	Maximum		Left	Right	
GS1 DataMatrix (ECC 200)	0.495 (0.0195")	3.50 (0.1378")	Height is determined by X-dimension and data that is encoded	1X on all four sides		1.5/(**)/660
GS1 QR Code	0.495 (0.0195")	3.50 (0.1378")	Height is determined by X-dimension and data that is encoded	4X on all four sides		1.5/(**)/660
GS1-128 (****)	0.495 (0.0195")	0.940 (***) (0.0370")	12.70 (0.500")	10X on left and right side		1.5/(**)/660

- (*) For optimal reader performance, a limited X-dimension range should be selected. For long distance scanning applications, X-dimensions greater than 1.75 mm (0.069") should be used.
- (**) For quality measurement of these GS1 symbols, the effective aperture should be 80% of the chosen X-dimension.
- (***) With an X-dimension at the upper end of the range, GS1-128 symbols have a limited data capacity because the maximum length is 165.10 mm (6.5"). See section [5.4.4.3](#).
- (****) The GS1-128 symbol may not be readable at the same distance as the GS1 DataMatrix and GS1 QR Code.

 **Note:** See section [2.7](#) to ensure the correct symbol specification table is used.

5.12.4 Barcode production

The following subsections will:

- Provide background on major barcode printing methods and materials.
- Provide general printing and packaging background for major application groups.
- Provide technical considerations for direct part marking (DPM).

The various definitions and specialist terms used throughout this section are found in *ISO/IEC 15419, Information Technology, Automatic Identification and Data Capture Techniques, Bar Code Digital Imaging and Printing Performance Testing*, *ISO/IEC 15416, Information technology, Automatic Identification and Data Capture Technologies, Bar Code Print Quality Test Specification – Linear Symbols* and *ISO/IEC 15415, Information technology, Automatic Identification and Data capture Techniques, Bar Code Print Quality Test Specification, Two-dimensional Symbols*.

5.12.4.1 Digital imaging

5.12.4.1.1 General requirements

General requirements consisting of the following topics are found in section 4 of *ISO/IEC 15419*.

- Data input.
- Quiet Zones.
- Classification of imaging device categories, from informative reference Annex E of *ISO/IEC 15419*.
- Programmer's examples, from informative reference Annex F of *ISO/IEC 15419*.
- Programmer's example for general-purpose printers.
- Programmer's example for indirect barcode imaging devices.
- Programmer's example for symbols distorted for plate roll circumference.
- Direct barcode imaging devices.
- Dedicated barcode printers.
- Adjustment of target element dimensions.
- Record of design elements.
- General purpose printers.
- Adjusted bar width compensation (BWC) (including the General Purpose Printer Dot/Pixel Comparison figure).
- Record of design attributes.
- Indirect barcode imaging devices.
- Adjustments for planned distortion (disproportioning).
- Adjustments for special EAN/UPC symbol characters.
- Test requirements:
 - System configuration.
 - Test procedure.
- Conformance.
- Test report, including sample test layout, from normative reference Annex A of *ISO/IEC 15419*
- Certification.
- Software specification, including classification of software categories, from informative reference Annex D of *ISO/IEC 15419* and functions of barcode production software from informative reference Annex G of *ISO/IEC 15419*.

- Maintenance and supplies, from informative reference Annex C of *ISO/IEC 15419*.

5.12.4.1.2 Dedicated barcode printers

Section 5 of *ISO/IEC 15419* contains information on dedicated barcode printers and includes the following topics:

- Data input requirements.
- Test requirements.
- Selection of equipment for testing.
- Test conditions; environment, equipment configuration.
- Test procedure.
- Conformance.
- Test report.
- Certification and labelling.
- Equipment specification.

5.12.4.1.3 EAN/UPC on-demand printed symbols at minimum size

In the past the term "magnification factor" was extensively used to specify the size of a barcode. This technique relied upon setting a nominal size (100 percent) that was directly related to a given X-dimension. Since January 2000, the term "X-dimension" has been used to specify permissible symbol sizes (see section [5.12](#)).

It is more difficult for the user to create high quality barcodes with general-purpose printers than it is with direct thermal transfer label printers. There are two reasons for this difficulty. First, the printed dot size for general-purpose printers is appreciably larger than the pixel dimension, as shown in the figure below. This causes the bars (dark bars) to be printed wider and the spaces (light bars) to be narrower than nominal, unless the software driving the printer corrects for this distortion. Second, the software that constructs the barcode may itself introduce dimensional errors.

Figure 5.12.4.1.3-1. Example of digital printing

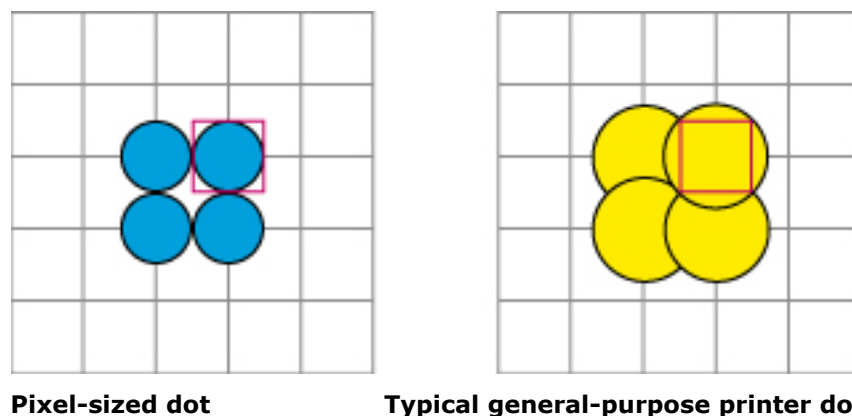

The most common printing densities used by on-demand, barcode printers are 200 and 300 dpi. However, due to the constraints of the dot pitch, these printers cannot print a minimum X-dimension of 0.264 mm (0.0104 inch) or 80 percent magnification symbol correctly. The closest to 80 percent that these printers can print is 75.7 percent or 76.9 percent depending on the exact dot geometry (see figure below).

Even though a minimum X-dimension of 0.264 mm (0.0104 inch or 80 percent magnification) is the minimum value specified, users of on-demand printers have used magnifications between 75 percent and 80 percent in point-of-sale (POS) scanning environments for years. They have done so with no significant reduction in scan rate, as compared to symbols printed precisely at 80 percent. Because larger in-specification symbols are always easier to scan, 80 percent symbols and larger

are preferred. However, when an on-demand printer is required, the 75 to 80 percent symbols are an acceptable alternative given the following qualifications for printing:

- The allowance for symbols from the EAN/UPC symbology family of magnifications from 75 to 80 percent is only applicable to on-demand (e.g., thermal, laser) print processes. For all other printing processes, 80 percent is attainable and is the minimum allowable size.
- When printing a minimum symbol with any method of printing, the area provided for printing the symbol, including the required Quiet Zones, SHOULD never be less than the area required for an 80 percent symbol. This area is derived from the total width of an 80 percent symbol times its height.
- When printing a minimum symbol with any method of printing, the symbol height SHALL NOT be truncated below minimum bar height as stated in the symbol specification tables.

Figure 5.12.4.1.3-2. Achievable X-dimensions for thermal printed EAN/UPC symbols

Reference DPI	Actual DPI	Dots per millimetre	Actual dot width (centre point to centre point)		Dots per module width	Module width (X-dimension)		(*) Corrected magnification
			inch	mm		inch	mm	
200	203.2	8	0.004921	0.12500	2	0.0098	0.250	(**) 75.76%
200	203.2	8	0.004921	0.12500	3	0.0148	0.375	113.64%
200	203.2	8	0.004921	0.12500	4	0.0197	0.500	151.52%
200	203.2	8	0.004921	0.12500	5	0.2461	0.625	189.39%
300	304.8	12	0.003281	0.08333	3	0.0098	0.250	(**) 75.76%
300	304.8	12	0.003281	0.08333	4	0.0131	0.333	100.01%
300	304.8	12	0.003281	0.08333	5	0.0164	0.417	126.26%
300	304.8	12	0.003281	0.08333	6	0.0197	0.500	151.52%
300	304.8	12	0.003281	0.08333	7	0.0230	0.583	176.77%
400	406.4	16	0.002461	0.06250	4	0.0098	0.250	(**) 75.76%
400	406.4	16	0.002461	0.06250	5	0.0123	0.312	94.70%
400	406.4	16	0.002461	0.06250	6	0.0148	0.375	113.64%
400	406.4	16	0.002461	0.06250	7	0.0172	0.437	132.58%
400	406.4	16	0.002461	0.06250	8	0.0197	0.500	151.52%
400	406.4	16	0.002461	0.06250	9	0.0221	0.563	170.45%
400	406.4	16	0.002461	0.06250	10	0.0246	0.625	189.39%
600	609.6	24	0.001640	0.04167	6	0.0098	0.250	(**) 75.76%
600	609.6	24	0.001640	0.04167	7	0.0115	0.292	88.38%
600	609.6	24	0.001640	0.04167	8	0.0131	0.333	101.01%
600	609.6	24	0.001640	0.04167	9	0.0148	0.375	113.64%
600	609.6	24	0.001640	0.04167	10	0.0164	0.417	126.26%
600	609.6	24	0.001640	0.04167	11	0.0180	0.458	138.89%
600	609.6	24	0.001640	0.04167	12	0.0197	0.500	151.52%
600	609.6	24	0.001640	0.04167	13	0.0213	0.542	164.14%
600	609.6	24	0.001640	0.04167	14	0.0230	0.583	176.77%
600	609.6	24	0.001640	0.04167	15	0.0246	0.625	189.39%

(*) The nominal EAN/UPC symbol is based on a module width (X-dimension) of either 0.0130 inch or 0.330 millimetre. In North America, long-standing GS1 US specifications set the nominal module size (X-dimension) at 0.0130 inch or 0.330 millimetres. The ISO/IEC specification for EAN/UPC symbols set the nominal module size (X-dimension) at 0.330 millimetre. The international metric nominal is 0.0606 percent smaller than the original inch-based nominal. The data in the right-most

column labelled "Corrected Magnification" are based on a nominal module width (X-dimension) of 0.330 millimetre.

(**) See figure 5.12.3.1-1 for when a magnification of less than 80% is acceptable

5.12.4.2 Barcode master image production

5.12.4.2.1 Introduction

For symbols in the EAN/UPC symbology family, the biggest usage of verification has always been in conjunction with printing and production of packaging and labels by means of the conventional or "wet ink" printing processes, such as offset lithography, flexography and photogravure. A barcode master image is required as part of the production of printing plates for these processes.

The first point at which one might use verification is a printability test before actual production of the symbols, where a printing run including a test symbol is carried out under normal conditions. The test barcode is then verified to characterise the printing process for a particular press and printing substrate. It is necessary to assess how much bar gain (or loss) has occurred and over what range of variation, to decide how much bar width adjustment (BWA) is required. Bar gain will mean that the printed bars are wider than those of the master image, so the master image will need to be adjusted to compensate for this. BWA can be in the form of bar width reduction (BWR), where there is bar gain, or the less common bar width increase (BWI). The required BWA is associated with the X-dimension used. These details are required in order to specify the master image correctly for the barcode origination software.

Figure 5.12.4.2.1-1. Example of bar width adjustment

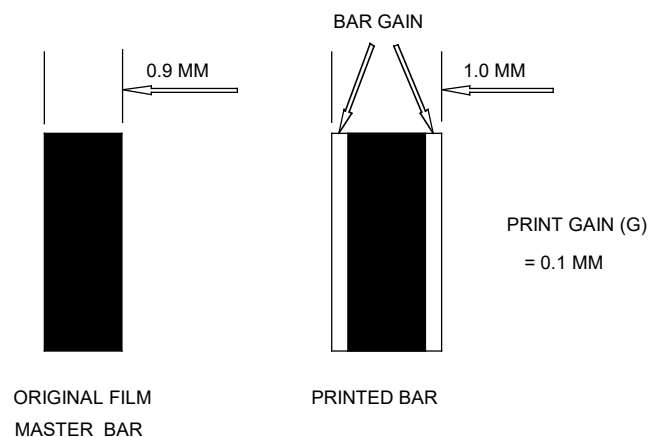

If a proof of the print job is produced, the barcode should be verified as part of the approval process. Note, however, that since proofing presses are not the same as production printing presses, there may be a slight difference in the quality of the proof and the production job.

While the presses are being made ready, a check of bar widths on the first few printed sheets can help to ensure that the press is correctly set to produce near-ideal bar widths. Once the presses have started to roll, periodic sampling should be carried out, at intervals based on experience or dictated by the company's quality control procedures, to monitor both bar widths and other aspects of symbol quality (in particular symbol contrast), since these are the attributes most easily adjusted during the run.

Finally, a further sample should be verified following completion of the print job. The Scan Reflectance Profile (SRP) analysis SHALL be used as the basis for decision making, to ensure that the job has achieved at least the minimum quality grade specified by the customer or based on the application.

The following items are recommended to accompany a master image file:

- X-dimension (magnification factor).
- Selected bar width reduction.

- Product identification, including company name.
- Printing process for which the master image is intended.
- Identification of the master image supplier.
- Date of master image manufacture.

5.12.4.2.2 Master image requirements

The master image must be produced at an appropriate resolution for the hardware device which will produce the physical image of the barcode on paper, photographic film, printing plate or other substrate. The associated software which converts the input data (the master image) into digital instructions to drive the hardware device is equally important. The general principles and requirements that should be followed are explained in ISO/IEC 15419 *Information Technology, Automatic Identification and Data Capture Techniques, Bar Code Digital Imaging and Printing Performance*. This international standard sets out general principles governing the barcode image generation function in each component, supplemented by more specific details applicable to certain major categories of software and hardware.

The physical requirements for a film master are found in section 6 of *ISO/IEC 15421 Information technology -- Automatic identification and data capture techniques -- Bar code master test specifications*.

5.12.4.3 Technical considerations for direct part marking (DPM)

Marking methods

It is important to analyse the selected method of marking in relation to several considerations:

- Finishes that cause an excess of shadowing or glare.
- Surfaces that do not provide sufficient contrast - less than 20 percent difference in surface reflectance.
- Safety critical parts that cannot be marked with intrusive methods.
- Marking method must comply with the users' requirements.
- Location of the symbol should not be:
 - In direct air/water (streams, etc.).
 - On sealing surfaces.
 - On surfaces subject to wear or exposure to heavy contact.

Intrusive (subtractive methods)

Intrusive marking refers to methods that remove or alter the material of the host.

- Abrasive blast
- Dot peen
- Electro-chemical marking, colouring, or etching
- Engraving/milling
- Fabric embroidery/weaving
- Direct laser marking
- Laser shot peening
- Laser Inducted Surface Improvement (LISI)
- Gas Assisted Laser Etch (GALE)
- Laser Induced Vapour Deposition (LIVD)

Non-intrusive (additive methods)

Non-Intrusive marking does not affect the host material; it usually involves the addition of material.

- Cast, forge, mold
- Inkjet
- Laser bonding
- Liquid metal jet
- Silk screen
- Stencil

Host (substrate) surface

Direct part marking of GS1 DataMatrix or GS1 QR Code SHOULD be reserved for surfaces no rougher than 250 micro inches (millionths of an inch) and for surfaces that are no smoother than 8 micro inches. Surfaces that fall outside these parameters need to be re-surfaced or marked using an alternative method.

Consideration of the surface colour must be taken. A minimum 20 percent difference in contrast between the host and the symbol is required. Altering the cell size in relation to the surface roughness should provide adequate contrast on cast surfaces.

(Cell size = (0.00006 X roughness) + 0.0067); (see figure below)

Figure 5.12.4.3-1. Cell size in relation to surface roughness

Average roughness	Cell size minimum
0,508 micrometres (20 micro inches)	0.1905 mm (0.0075 in.)
1,524 micrometres (60 micro inches)	0.2286 mm (0.009 in.)
3,048 micrometres (120 micro inches)	0.381 mm (0.015 in.)
5,08 micrometres (200 micro inches)	0.508 mm (0.020 in.)
7,62 micrometres (300 micro inches)	0.635 mm (0.025 in.)
10,668 micrometres (420 micro inches)	0.762 mm (0.030 in.)

Substrate surface thickness

A minimum host surface thickness is recommended as is a maximum marking depth. Both are outlined in the table below.

Figure 5.12.4.3-2. Marking depth and surface thickness by method

Method	Min. thickness	Max marking depth
Dot Peen	1.016 mm (0.04 in.)	0.102 mm (0.004 in.)
Laser Shot peening	0.508 mm (0.02 in.)	0.051 mm (0.002 in.)
Laser Bonding	0.025 mm (0.001 in.)	Surface Mark
Abrasive Blast	0.076 mm (0.003 in.)	0.008 mm (0.0003 in.)
Electro-Chemical Colouring	0.508 mm (0.02 in.)	0.051 mm (0.002 in.)
Laser Etch	0.762 mm (0.03 in.)	0.076 mm (0.003 in.)
LISI	1.016 mm (0.04 in.)	0.102 mm (0.004 in.)
Laser Engraving	1.27 mm (0.05 in.)	0.127 mm (0.005 in.)
Electro-Chemical Etch	2.54 mm (0.1 in.)	0.254 mm (0.01 in.)
Micro-Milling	31.75 mm (1.25 in.)	3.175 mm (0.125 in.)

5.12.5 Quality assessment

5.12.5.1 Verification

Verification is the technical process by which a barcode is measured to determine its conformance with the specification for that symbol. Verification is not intended to be used alone as a method for downstream rejection. For example, GS1's advice is to use the *ISO/IEC 15416* or *ISO/IEC 15415* methodologies as the basis to improve overall scanning performance. An ISO/IEC-based verifier is of enormous assistance in diagnosing the problem and providing a standard means of reporting among printing companies and their trading partners.

It is also important to note the difference between a scanner and a verifier. A verifier is a measuring tool by which one can make certain determinations concerning the ability of the symbol to do its job, namely, to carry and deliver data on demand.

When interpreting the results from verification it is also important to remember that:

- Most verifiers do not measure symbol height.
- Without additional software linking the decoded data to a database, the quality and accuracy of the data content of a symbol cannot be confirmed.
- The verifier does not check that the human readable interpretation matches the barcode data (and it is necessary to check that the two correspond, particularly where the barcode generating software does not include human readable interpretation data).
- Because only a sample of the symbols produced are actually verified, the quality of all the symbols in a production batch cannot be guaranteed beyond the statistical confidence limits associated with the sampling rate used.
- Even a perfect symbol at the time of production can be damaged or otherwise affected in its passage through the supply chain (e.g., scratched, frozen, dampened).
- Operator error can cause inconsistent results. Operators should be properly trained and visual checks should be made to confirm verifier results (e.g., where the barcode is expected to get a good result and fails the verifier test, recheck the operation of using the verifier).
- The correct barcode has been printed for the scanning environment of the item (e.g., an ITF-14 symbol SHALL NOT be used on an item intended for retail point-of-sale).

5.12.5.1.1 Traditional verification (informative)

Traditional verification methods were introduced in the early to mid-1970s and were based on the measurement of two symbol parameters: print contrast signal (PCS) and the bar width deviation. If the bar (or space) widths were within a defined (but somewhat arbitrary) tolerance and if PCS was above a defined minimum value, the symbol was regarded as being "in spec."

Initially, none of these measurements were automated and human factors affected the accuracy and consistency of measurements. Also, checking that the symbol was correctly encoded was a laborious task. However, within a few years, instruments were developed that performed these measurements automatically. These were the first true verifiers that enabled the printer to take steps to produce the symbols as nearly perfectly as this process allowed.

Traditional verification does not necessarily give results that correlate very closely with the actual scanning performance of the symbols. One reason is that the assessment of the symbol gives only a single threshold for acceptability: "Pass" or "Fail." In addition, if the assessment is based on a single scan across the symbol, which might be through an exceptionally good or bad section of the symbol, it cannot be guaranteed to be truly representative of its condition.

Measurements of bar gain or loss are less meaningful in the case of certain symbologies, like the EAN/UPC symbology and the GS1-128 barcode, where decoding relies primarily on edge-to-similar-edge distances, which are relatively immune to even substantial amounts of consistent gain or loss across the symbol. These distances are measured from the leading edge of one bar to the leading edge of the next (or from one trailing edge to the next), which tends to move in the same direction if there is bar gain or loss. A more subtle factor is that the method is not standardised, either as to where the dark and light reflectance (or density) measurements are made for the calculation of PCS, or as to how the exact position of an element edge is defined, so that some models of verifier could

assess a given symbol as "Pass" whereas others could "Fail" it – a source of potential and, indeed, actual disagreements among suppliers and customers.

5.12.5.1.2 ISO/IEC verification

During the 1980s a group of experts from barcode and user industries working on all types of scanning systems determined the factors that most directly affect symbol-scanning performance and resulted in the analysis of the Scan Reflectance Profile (SRP). This methodology was originally known as ANSI verification because it was first described in the United States' standard ANSI X3.182, published in 1990 under the title *Bar Code Print Quality Guidelines*. The method was then defined in a European standard (*EN 1635*), originally published in 1995, and an International Standard (*ISO/IEC 15416*), originally published in 2000. *ISO/IEC 15416* is the definitive international specification of the ISO/IEC linear barcode verification methodology, and the numeric grading system is used.

The method, as described in the *ISO/IEC 15416* standard, is technically fully compatible with the ANSI X3.182 and *EN 1635* method, so verifiers based on these standards are not obsolete.

ISO/IEC 15415 is the equivalent definitive international standard for two-dimensional barcode symbols, with one methodology applicable to multi-row barcodes and the other to two-dimensional matrix symbols. In addition *ISO/IEC TR 29158 Direct Part Mark (DPM) Quality Guideline* is relevant when assessing the quality of symbols marked directly to the surface of an item.

In simple terms, an ISO/IEC verifier looks at the symbol in exactly the same way a scanner sees it. The ISO/IEC verifier reports its assessment of the symbol quality not as a single pass or fail decision, but as one of a range of four passing grades (from 4 to 1, in order of decreasing quality) or one failing grade (0). This enables an application to set the most appropriate minimum grade for acceptability. It may be noted that the ANSI standard uses the alphabetic scale A to D for passing grades and F for failing symbols, but the grade thresholds are identical.

The relationship between symbol grades measured in this way and the way the symbols behaved when they were scanned was so close that users rapidly came to accept the SRP assessment method for verifying symbols received from their trading partners. Users knew that as long as a symbol achieved grade 1.5 or better it would give them acceptable performance when they had to scan it to capture the encoded data.



Note: The GS1 system requires that the Quiet Zone be a measured parameter for EAN/UPC Symbology, GS1-128 symbols and ITF-14 symbols per the values expressed in *ISO/IEC 15416*, section 5. For GS1 DataMatrix it is equal to one X-dimension expressed in *ISO/IEC 16022* section 7 and for GS1 QR Code it is equal to four times the X-dimension expressed in *ISO/IEC 18004:2015*.

5.12.5.1.3 Types of verifiers

The *ISO/IEC 15426* standard, which is in two parts, defines the test methods and minimum accuracy criteria for verifiers using the methodologies of *ISO/IEC 15416* (for linear barcodes) and *ISO/IEC 15415* (for multi-row barcodes and two-dimensional barcode symbols). *ISO/IEC 15426-1* relates to linear barcode verifiers and *ISO/IEC 15426-2* to two-dimensional barcode verifiers.

There are many types of verifier that meet the requirements of *ISO/IEC 15426*, some that are used in conjunction with a personal computer with special verification software for the symbol analysis and display/printing of results, while others are integrated stand-alone units. In addition, some verifiers may have interchangeable measuring apertures and light sources to enable measurement of symbols with a wide range of X-dimensions and to meet the illumination needs of differing application standards.

5.12.5.2 Measurement methodology

The symbol must be verified in its final configuration wherever possible (e.g., including over-laminate, package material, contents), but if this is not feasible, the following procedure is recommended to allow for the effects of show-through.

Place the symbol to be verified on a flat surface. If the substrate is not opaque (allows light through), perform the verification procedure with the symbol on a dark surface and then repeat it on a light surface. Take the poorer set of results, unless it is known what type of material is likely to back the symbol in practice, in which case attempt to match it.

5.12.5.3 Symbol grading

Symbol Grading for linear symbols consisting of the following topics is found in section 6 of *ISO/IEC 15416*:

- Scan Reflectance Profile (SRP) grading (further explained in normative reference Annex B of *ISO/IEC 15416*).
- Decode.
- Reflectance parameter grading (including the Reflectance Parameter Grading figure).
- Decodability (including the Decodability Grades figure; also covered in normative reference Annex A of *ISO/IEC 15416*).
- Expression of symbol grade.
- Symbol grading process flowchart is available from normative reference Annex C of *ISO/IEC 15416*.
- Guidance on the verification report template is available in section [5.12.7](#) Barcode verification template.

Symbol Grading for two dimensional symbols consisting of the following topics can be found in section 5 of *ISO/IEC 15415*:

- Expression of quality grades.
- Overall Symbol Grade.
- Reporting of the Symbol Grade.
- Symbology-specific parameters and values for symbol grading (further explained in normative reference Annex A of *ISO/IEC 15415*).
- Symbology grading flowchart for two-dimensional barcode symbols (further explained in informative reference Annex B of *ISO/IEC 15415*).
- Guidance on selection of grading parameters in application specification available from informative reference Annex D of *ISO/IEC 15415*.

5.12.5.4 Substrate characteristics

Substrate characteristics consisting of the following topics are found in the informative reference Annex D of *ISO/IEC 15416* and informative reference Annex E of *ISO/IEC 15415*

- Substrate opacity
- Gloss
- Over-laminate
- Static reflectance measurements
- Prediction of symbol contrast
- Prediction of minimum edge contrast ($E_{c_{min}}$) and modulation (MOD)
- Acceptability of measured and derived values

5.12.5.5 Interpretation of the scan reflectance profile and profile grades

Interpretation of the scan reflectance profile (SRP) and profile grades consisting of the following topics is found in the informative reference Annex E of *ISO/IEC 15416* and informative reference Annex C of *ISO/IEC 15415*:

- Significance of SRPs
- Interpretation of results
- Matching grades to applications
- Alphabetic grading

5.12.5.6 Comparison with traditional methodologies

Comparison with traditional methodologies consisting of the following topics is found in the informative reference Annex I of *ISO/IEC 15416*:

- Traditional methodologies
- Correlation of print contrast signal with symbol contrast measurements
- Guidance on grading for applications also specifying print contrast signal (PCS)

5.12.5.7 Process control requirements

Process control requirement methodologies consisting of the following topics are found in the informative reference Annex J of *ISO/IEC 15416*:

- Process control for repetitive printing
- Number of scans
- Bar width deviation
- Two-width symbologies
- (n,k) symbologies
- Average bar gain/loss

Average bar error is not graded directly, but is used to calculate what fraction of a defined bar tolerance is consumed by the printing process. This traditional bar tolerance calculation differs by symbology and, in the case of the EAN/UPC symbology, it also differs by the X-dimension at which the symbol is printed. Generally, a smaller X-dimension yields a smaller tolerance.

5.12.5.8 Compliance statement

Verifiers that are suitable for use with the recommendations contained in these *GS1 General Specifications* will typically be supplied with a statement that associates the instrument with a calibration conformance test card.

5.12.5.9 Calibrated conformance standard test cards

The verifier operator may use a variety of tools and procedures to periodically ensure maintenance of the verifier's calibration. For example, the operator may follow the manufacturer's recommended procedure for set-up, programming (if necessary), normal operational calibration and use of the verifier prior to performing any tests. Indeed such procedures are considered essential to ensure the consistency of verification results over time.

Some verifier manufacturers may require the operator to utilise a calibration patch designed for use in maintaining instrument calibration. A common form of patch is often referred to as a "reflectance patch," which may be provided with the instrument. It is very important that the manufacturer's instructions are followed carefully and conscientiously to properly calibrate the instrument. An indication of "calibration complete" normally signals successful recalibration of the device. Other manufacturers may require periodic factory calibration of their verifier to maintain proper calibration.

With the increasing use of verifiers as communication tools, all verifiers must be periodically checked for their calibration conformance to a traceable standard (within accuracy and repeatability limits stated by the manufacturer). For this reason, Calibrated Conformance Standard Test Cards are available for the verifier user.

Calibrated conformance standard test cards have been designed for verifiers with 6, 8, 10 and 20 mils apertures and the following are currently available from your GS1 Member Organisation:

- EAN/UPC Calibrated Conformance Standard Test Card.
- ITF Calibrated Conformance Standard Test Card.
- GS1-128 Calibrated Conformance Standard Test Card.
- GS1 DataBar Calibrated Conformance Standard Test Card.
- GS1 DataMatrix Calibrated Conformance Standard Test Card.

Use of these test cards provide a number of benefits including:

- Validates verifiers for UPC-A, EAN-13, ITF, GS1-128, GS1 DataMatrix and GS1 DataBar symbols. Covers all GS1 symbologies except Composite Component and GS1 QR Code.
- Training tool for operators of verifiers.
- Validates that the verifier is working within its specified tolerances for the symbology selected.

Each test card is designed to test particular characteristics of *ISO/IEC 15416* and *ISO/IEC 15415* - based verification equipment. The standards are manufactured on special materials and are made traceable to the National Institute of Standards and Technology (NIST).

The idea behind the standard is to regularly test the verification equipment to ensure it is operating within ISO tolerance levels as published by the verifier manufacturer. This is especially important in heavy use applications where various operators may be involved or where a new user is learning to properly verify. The operator should routinely scan each of the symbols on the test card to determine if the verifier device provides the values listed. These specifications stipulate an aperture and 660 nanometres +/-10 nanometres wavelength be used, and the exact scanning method should be determined by following all of the verifier manufacturer recommendations. This may require some practice to obtain the right touch, but it will inform the operator when the correct method has been used.

If the verifier reports values that agree with the values listed on the test card (within the verifier manufacturer's stated accuracy and repeatability limits), then the operator can assume the verifier is calibrated. If, after repeated attempts, the device does not provide the value as printed on the standard (within the verifier manufacturer's stated accuracy and repeatability limits), then the device or the operator's scanning technique must be considered suspect. In this event, the operator should refer to his or her operator's manual as to the proper remedies specified by the verifier manufacturer.

Test cards are sensitive and should be handled with care. If the symbols show dirty areas, one can safely clean these by using a soft cotton pad and photographic grade film cleaner. If visible scratches develop on a symbol, that area of the symbol SHALL NOT be used. If sufficient visible scratches develop so that a clean scan path is not available, then the test card is no longer useable and SHALL be replaced.

The test card serves as a device for, or means of, confirming that an ISO-based verifier has been properly calibrated and that users are obtaining results within the accuracy limits stated by the manufacturer of their instruments.

It is possible that a defective verifier, use of a damaged or incorrect reflectance patch, or, in some cases, a careless user performing the calibration to the patch might provide a false indication of successful calibration. The proper use of the Calibrated Conformance Standard Test Cards is the only way multiple trading partners can be assured of reliable quality measurements for the printed GS1 endorsed symbol.

As a general rule, any ISO-based verifier (NIST or non-NIST traceable) should be periodically tested using a Calibrated Conformance Standard Test Card. This procedure will confirm both the accuracy of the instrument and the skill of the user.

5.12.5.10 Special considerations for verification of GS1 system symbologies

5.12.5.10.1 General

Since ISO verification does not measure dimensions, it is part of the additional visual checking that has to be carried out to ensure that, for example, the symbol height meets the application requirements.

With better digital imaging software, element dimensions can only be adjusted automatically to the nearest integer number of pixels in the output device, be it imagesetter or printer, enabling element width ratios to be maintained with allowance duly made, for example, for bar gain/loss and adjustment of element widths for digits 1, 2, 7 and 8 in EAN/UPC symbols. This means that symbol sizes may not match those input as target dimensions, but will vary in discrete steps within the permitted range, which will result in a more accurate symbol overall.



Note: For a list of international standards pertaining to GS1 system symbologies, see section [5.1.2](#)

5.12.5.10.2 Acceptance criteria

The acceptance criteria are intended to confirm that symbols adhere to all the requirements in the symbol specification tables with an allowance for a small measurement variation between commercial verifiers or operators:

- X-dimension is to have an Acceptance Criteria of 2% (-2% on the minimum specified X-dimension and +2% on the maximum specified X-dimension).
- The measurements for height and each Quiet Zone have an Acceptance Criteria of 5% (-5% on the minimum specified dimension and +5% on the maximum specified dimension).

5.12.5.10.3 EAN/UPC symbology

The main characteristic of the EAN/UPC symbology that affects verification is the different treatment of the three sets of symbol characters for digits 1, 2, 7 and 8 from the remaining digits (0, 3, 4, 5, 6 and 9). The reference decode algorithm uses the combined width of both bars in these characters to discriminate between a 1 and a 7, and between a 2 and an 8, which are ambiguously decodable since they share the same set of edge-to-similar-edge modular dimensions. The addition to or subtraction from the element widths of 1/13 module is intended to increase the differences between the sums of the bar widths for each pair of ambiguous characters. The decodability parameter for these characters takes account of bar gain and loss whereas it does not for the remaining symbol characters. Consequently, a symbol not containing any of these four symbol characters may suffer substantial bar gain or loss without degrading its decodability, whereas a symbol that does contain one or more of them is likely to have a lower decodability grade, with the same amount of bar gain or loss. However, the laws of probability suggest that only some 6.9 percent of symbols would not be affected by this, so it is wise to be cautious and assume that bar gain or loss is a possible cause of a poor decodability grade for EAN/UPC symbols. It is also wise (for process control purposes) not to assume that the decodability grade correlates with bar width deviation, but it is far safer and easier to rely on the traditional measurement of bar width deviation for adjusting the production process.

The measuring aperture for EAN/UPC symbols is either 6 or 10 mils, depending on the application, as specified by the symbol specification tables.

Additional EAN/UPC symbol grading criteria

ISO/IEC 15416 Bar code print quality test specification - Linear symbols allows for additional pass/fail criteria to be stipulated by a symbology specification. For the EAN/UPC symbology, the minimum Quiet Zone dimensions are given in [5.2.3.4](#). Any individual scan profile which does not meet these requirements allowing for the following tolerances SHALL receive a grade of "0".

Figure 5.12.5.10.3-1. Minimum width of measured Quiet Zones

Symbol version	Left Quiet Zone	Right Quiet Zone
EAN-13	10X	6.2X
EAN-8	6.2X	6.2X
UPC-A	8X	8X
UPC-E	8X	6.2X
Add-ons (EAN)	EAN 13/8 right QZ	4.2X
Add-ons (U.P.C.)	UPC A/E right QZ	4.2X

Symbols that fall below range defined in [5.2.6.7](#) SHALL receive a grade of 0 (see [5.12.6.3](#) for exception).

 **Note:** The choice of minimum Quiet Zone dimension was based on the historical U.P.C. Quality Guideline. Since EAN-13 and EAN-8 were not included, minimum Quiet Zone dimension similarly derived were chosen for those symbols.

5.12.5.10.4 GS1-128 symbology

The important aspects to verify for a GS1-128 symbol are its print quality, which is assessed in the standard way, and its formatting, which may need to be visually checked from the information output by the verifier. The Code 128 symbology is an edge-to-similar-edge decodable symbology, but its reference decode algorithm also requires a check of the sum of the widths of the three bars in each character as part of its parity checking process. Consequently, its decodability is affected by bar gain or loss.

Measuring apertures for GS1-128 symbols are 6 or 10 mils depending on the application and are specified in the symbol specification tables.

Data contained in GS1-128 symbols must be formatted according to these specifications for the use of GS1 Application Identifiers (AIs). Specific features to check are:

- Presence of Function 1 Symbol Character (FNC1) as a flag for the GS1 system subset of the Code 128 symbol, in the first position after the start character.
- Use of FNC1 or the control character <GS> (ASCII value 29 (decimal), 1D (hexadecimal)) as a separator character following non-predefined length element strings.
- Sequencing of AIs, with predefined length AIs preceding non-predefined length ones.
- Length of data fields with fixed length AIs.
- Correct formatting of data in all AI fields.
- Absence of encoded parentheses around AIs.
- The extent to which a verifier can do this automatically will vary greatly among devices, even those that have GS1-128 symbols as a specific symbology option.

5.12.5.10.5 ITF-14 symbology

ITF-14 barcodes are, unlike the others used in the GS1 system, two-width (narrow/wide) symbols that cannot be decoded by the edge-to-similar-edge technique, but all element widths must be measured. They are, therefore, more subject to the problems caused by bar gain or loss.

The standard ISO verification technique is fully applicable to these symbols. However, in the GS1 system application, additional checks must be made to ensure that the X-dimension is within the permitted range.

Measuring apertures for the ITF-14 symbol SHALL be 10 mils for symbols with an X-dimension less than 0.635 millimetre (0.0250 in) and SHALL be 20 mils for symbols with an X-dimension equal to or greater than 0.635 millimetre (0.0250 in).

The minimum acceptable grade for symbols printed with the higher range of X-dimension (above 0.635 millimetre or 0.0250 in) SHALL be 0.5/20/660. This is because the brown corrugated

substrates on which such symbols are often printed typically have a reflectance value below 40 percent, and sometimes below 30 percent, and cannot, therefore, ever achieve a symbol contrast better than 40 percent (the lower threshold for a grade 2 symbol contrast) no matter how dense the ink or how well the other attributes of the symbol are graded. As a result, the Scan Reflectance Profile (SRP) grade will most often be dictated by symbol contrast, so it cannot be higher than 1 for symbols on these materials, giving a maximum achievable overall symbol grade of 1.0.

Such symbols may also be affected by the inherent interference in the background reflectance caused by the substrate's composition, which may well lead to reduced defect grades and possibly low edge contrast and modulation values. It is, therefore, desirable to ensure that symbols printed on these corrugated materials are of as high a quality as possible in respect of the other parameters.

5.12.5.10.6 GS1 DataMatrix

Determining symbol quality for items marked with GS1 DataMatrix (both traditionally printed and direct part marked - DPM) involves a specialised approach due to the physical nature of the marking and the optical systems used to read those symbols. The minimum symbol quality grade for GS1 DataMatrix symbols SHALL be specified by the application specification. The measurement of the quality parameters for DPM symbols SHALL be made by a verifier conforming to *ISO/IEC 15415* and when direct marked augmented with *ISO/IEC TR 29158* which defines DPM quality specific alternative illumination conditions, terms, parameters, modifications to the measurement and grading of certain parameters and the reporting of the grading results. According to these standards an overall grade is shown in the form:

Grade/Aperture/Light/Angle

Where:

- **"Grade"** is the overall symbol grade as defined in *ISO/IEC 15415 Information technology - Automatic identification and data capture techniques - Bar code print quality test specification - Two-dimensional symbols* (e.g., the arithmetic mean to one decimal place of the Scan Reflectance Profile or scan grades) with the additional information found in *ISO/IEC 29158 Information technology; Automatic identification and data capture techniques; direct part mark (DPM) Quality Guideline*. For GS1 DataMatrix, the grade number may be followed by an asterisk, *, which indicates that the surroundings of the symbol contain extremes of reflectance that may interfere with reading. For most applications, this should be specified as causing the symbol to fail.
 - **"Aperture"** is the diameter in thousandths of an inch (to the nearest thousandth) of the synthetic aperture defined in *ISO/IEC 15415 Information technology - Automatic identification and data capture techniques - Bar code symbol print quality test specification - Two-dimensional symbols*.
 - **"Light"** defines the illumination: A numeric value indicates the peak light wavelength in nanometres (for narrow band illumination); the alphabetic character W indicates that the symbol has been measured with broadband illumination ("white light"), the spectral response characteristics of which must imperatively be defined or have their source specification clearly referenced.
 - **"Angle"** is an additional parameter defining the angle of incidence (relative to the plane of the symbol) of the illumination. It SHALL be included in the reporting of the overall symbol grade when the angle of incidence is other than 45 degrees. Its absence indicates that the angle of incidence is 45 degrees.
- ✓ **Note:** This international standard provides for 30 degrees and 90 degrees illumination in addition to the default 45 degrees.

The aperture is normally specified as being 80 percent of the minimum X-dimension allowed for the application. The printing method must produce the GS1 DataMatrix "L" pattern with gaps between the dots less than 25 percent of the specified aperture. If symbols with greater than the minimum X dimension are allowed by the application, the same absolute maximum gap dimension must be maintained.

5.12.5.10.7 GS1 QR Code

Determining symbol quality for items marked with GS1 QR Code symbols involves a specialised approach due to the physical nature of the marking and the optical systems used to read those marks. The minimum symbol quality grade for GS1 QR Code symbols SHALL be specified by the application specification. The overall grade is shown in the form minimum grade/aperture/measuring wavelength.

Grade/Aperture/Light/Angle

Where:

- **"Grade"** is the overall symbol grade as defined in *ISO/IEC 15415 Information technology - Automatic identification and data capture techniques - Bar code print quality test specification - Two-dimensional symbols* (e.g., the arithmetic mean to one decimal place of the Scan Reflectance Profile or scan grades). For GS1 QR Code, the grade number may be followed by an asterisk, *, which indicates that the surroundings of the symbol contain extremes of reflectance that may interfere with reading. For most applications, this should be specified as causing the symbol to fail.
- **"Aperture"** is the diameter in thousandths of an inch (to the nearest thousandth) of the synthetic aperture defined in *ISO/IEC 15415 Information technology - Automatic identification and data capture techniques - Bar code symbol print quality test specification - Two-dimensional symbols*.
- **"Light"** defines the illumination: A numeric value indicates the peak light wavelength in nanometres (for narrow band illumination); the alphabetic character W indicates that the symbol has been measured with broadband illumination ("white light"), the spectral response characteristics of which must imperatively be defined or have their source specification clearly referenced.
- **"Angle"** is an additional parameter defining the angle of incidence (relative to the plane of the symbol) of the illumination. It SHALL be included in the reporting of the overall symbol grade when the angle of incidence is other than 45 degrees. Its absence indicates that the angle of incidence is 45 degrees.

The aperture is normally specified as being 80 percent of the minimum X-dimension allowed for the application.

5.12.5.10.8 GS1 DotCode

The minimum symbol quality grade for GS1 DotCode symbols SHALL be specified by the application specification. The overall grade is shown in the form minimum grade/aperture/measuring wavelength/angle.

Grade/Aperture/Light/Angle

Where:

- **"Grade"** is the overall symbol grade as defined in *ISO/IEC 15415 Information technology - Automatic identification and data capture techniques - Bar code print quality test specification - Two-dimensional symbols*. For GS1 DotCode, the grade number may be followed by an asterisk, *, which indicates that the surroundings of the symbol contain extremes of reflectance that may interfere with reading. For most applications, this should be specified as causing the symbol to fail.
- **"Aperture"** is the diameter in thousandths of an inch (to the nearest thousandth) of the synthetic aperture defined in *ISO/IEC 15415 Information technology - Automatic identification and data capture techniques - Bar code symbol print quality test specification - Two-dimensional symbols*.
- **"Light"** defines the illumination: A numeric value indicates the peak light wavelength in nanometres (for narrow band illumination); the alphabetic character W indicates that the symbol has been measured with broadband illumination ("white light"), the spectral response characteristics of which must imperatively be defined or have their source specification clearly referenced.

"Angle" is an additional parameter defining the angle of incidence (relative to the plane of the symbol) of the illumination. It SHALL be included in the reporting of the overall symbol grade when the angle of incidence is other than 45 degrees. Its absence indicates that the angle of incidence is 45 degrees.

5.12.5.11 Possible causes of less-than-perfect verification grades

5.12.5.11.1 Reflectance parameters

Symbol contrast is governed by the reflectance of the substrate and ink. A symbol printed in black ink on a white paper will almost certainly achieve the top grade 4 for symbol contrast, as white papers typically have reflectance in excess of 75 percent, and black ink will usually have about 3 to 8 percent reflectance. Coloured backgrounds or coloured inks will affect the result. Highly glossy materials may also appear to have a lower background reflectance than expected. The worst case may be when printing on a corrugated brown fibreboard material, which may have a reflectance in a range between 27 and 40 percent, so even with a very dense, low reflectance ink it can never achieve better than the minimum passing grade 1 for symbol contrast (grade 1 includes symbol contrast values from 20 to 39 percent).

The causes of low symbol contrast and the solutions are:

- Background too dark: Use lighter or less glossy material, or change background colour (if printed) to one with higher reflectance.
- Bars too light: Change bar colour for one with lower reflectance, and increase ink weight or print head temperature (thermal printing) (Watch for consequential increase in bar widths).
- Show-through of contents: Use more opaque material for package, or print opaque white underlay prior to printing symbol.
- Show-through of imprint: Use more opaque labels.

Minimum reflectance, or R_{min} , must always be equal to or less than half the highest reflectance value, R_{max} . In practice, this means that the reflectance of at least one bar must meet this criterion. For example, if R_{max} is 70 percent, at least one bar must have a reflectance of 35 percent or less. A symbol that fails on this parameter will almost certainly have a low symbol contrast grade also. The cause of and solution for R_{min} being too high include:

- Bars too light: Change bar colour to one with lower reflectance, and increase ink weight or print head temperature (thermal printing) (Watch for consequential increase in bar widths).

Minimum Edge Contrast (EC_{min}) will always be lower than symbol contrast, but will only be a problem in itself if it approaches or drops below 15 percent (the pass/fail threshold). However, low edge contrast (EC) values, acceptable under this criterion, may still cause low modulation (MOD) grades. The causes of a low value of EC_{min} and the possible remedies are:

- Local variations in background reflectance (e.g., fragments of darker material in a recycled material): Use a more consistent substrate or one with higher reflectance.
- Local variations in inking of the bars: Adjust press settings to ensure even inking.
- Show-through of contents: Use more opaque material for package, or print opaque white underlay prior to printing symbol.
- Elements adjoining the edge in question are excessively narrow relative to the measuring aperture used: Increase X-dimension; ensure correct measuring aperture is used; ensure correct bar width adjustment (BWA) applied to film master/original symbol; print bars marginally narrower than spaces of same modular dimension.

Modulation, being calculated as the percentage of symbol contrast represented by the EC_{min} , will be reduced for the same reasons as when EC_{min} is low in the symbol. A scanner will tend to see spaces as narrower than bars and also to see narrow elements as less distinct than wider ones. Consequently, if there is significant bar loss, modulation will be reduced. Measuring with an aperture that is too large for the X-dimension will also reduce modulation.

The causes of a low value of modulation (often listed as "MOD" on verification reports) and the possible remedies are:

- Local variations in background reflectance (e.g., fragments of darker material in a recycled material): Use a more consistent substrate or one with higher reflectance.
- Local variations in inking of the bars: Adjust press settings to ensure even or darker inking.
- Show-through of contents: Use more opaque material for package, or print opaque white underlay prior to printing symbol.
- Element(s) adjoining the edge in question appear excessively narrow relative to the measuring aperture used: Increase X-dimension; ensure correct measuring aperture is used; apply correct BWA when originating symbol; print bars marginally narrower than spaces of same modular dimension.

5.12.5.12 Other parameters

Decode is graded on a pass/fail basis by applying the reference decode algorithm to the edge positions and element widths determined for the symbol. A failure to decode may be evidence of the symbol being incorrectly encoded, which may include an incorrect check digit. It also may indicate either that the bars and spaces initially identified by the global threshold are too many or too few for a valid symbol or that one or more edge positions are ambiguous. The possible causes of decode failure and possible remedies are:

- Symbol incorrectly encoded: Re-originate symbol; over-label with correctly encoded symbol.
- Check digit incorrectly calculated: Correct software error in origination system; re-originate symbol; over-label with correctly calculated symbol.
- Gross element width errors due to excessive bar gain or loss, or to defects: Apply correct bar width adjustment (BWA) when originating symbol; adjust press or printer settings.
- Too many elements detected due to defects: Correct cause of defects; adjust press (relief printing processes) to reduce haloing; replace print head (thermal/ink-jet printing).
- Too few elements detected (failure to cross global threshold): Refer to solutions for edge contrast (EC).

In the ISO standard, a decode failure occurs because an incorrect number of elements has been perceived to be present, either because the profile of one or more elements has failed to cross the global threshold or because a gross defect has caused one element to be seen as three or more, corresponding to the separately graded Edge Determination failure in the ANSI standard, which may also be reported by some verifiers following the ANSI methodology.

Figure [5.12.5.12-1](#) shows a symbol in which the narrow spaces have been partly filled in, reducing their contrast below the global threshold and causing an edge determination or decode failure. This could also be interpreted as an extreme example of modulation (MOD).

Figure 5.12.5.12-1. Symbol with edge determination problem



Figure [5.12.5.12-2](#) illustrates a Scan Reflectance Profile (SRP) showing narrow space profiles failing to reach the global threshold, giving an (ISO) decode failure or (ANSI) edge determination failure.

Figure 5.12.5.12-2. Scan Reflectance Profile with narrow space profiles

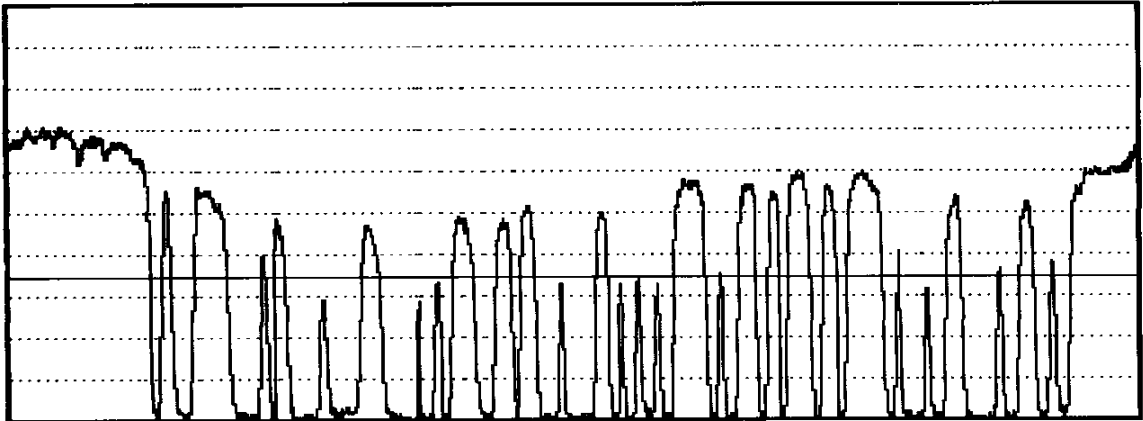

Decodability grades are influenced by bar gain or loss in most symbologies and by distortion of the symbol. Distortion can occur with relief printing processes, such as flexography, when the printing plate is stretched around the press cylinder with the bars parallel to the cylinder axis (e.g., at right angles to the print direction). A common reason for distortion with digitally-originated images is that they have been rescaled in graphics software, resulting in uneven addition or removal of pixels to or from the element widths. Print processes that tend to produce irregular bar edges, such as ink-jet and photogravure, will also be likely to give lower decodability grades. The causes of a low value of decodability and the possible remedies are:

- Bar gain/loss (systematic): Apply correct bar width adjustment (BWA) when originating symbol; adjust press settings.
- Element width gain/loss (non-systematic): Correct missing pixels (burnt-out print head elements, blocked ink-jet nozzles); rectify cause of defects.
- Distortion of symbol (uneven stretching of flexographic plate; non-linear disproportioning in plate-making process): Print symbol with height of bars parallel to direction of printing; do not disproportion barcode image in plate-making.
- Rescaling of digitally-originated images: Ensure symbol is created in correct size; ensure software matches module widths to integer number of pixels after all adjustments.
- Irregular element edges (ink-jet, photogravure, screen process printing): Change print technology; increase X-dimension; re-orient symbol relative to cylinder engraving angle/screen mesh.

The symbol in figure [5.12.5.12-3](#) is taken from the *GS1 Calibrated Conformance Standard Test Card* and has an engineered low decodability grade of 50 percent. As may be determined from the accompanying Scan Reflectance Profile (SRP), just to the left of halfway across the symbol, the width of a two-module bar has been increased in the sixth digit (and since the character is a 1, its decodability is affected by bar width). Although the original symbol has a very consistent image density, the profile also shows the effect of modulation (MOD), most noticeably on the narrow spaces.

Figure 5.12.5.12-3. Calibration symbol with engineered low decodability grade

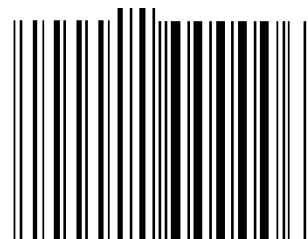

DECODABILITY (BAR)

Figure 5.12.5.12-4. Scan Reflectance Profile of symbol with low decodability character

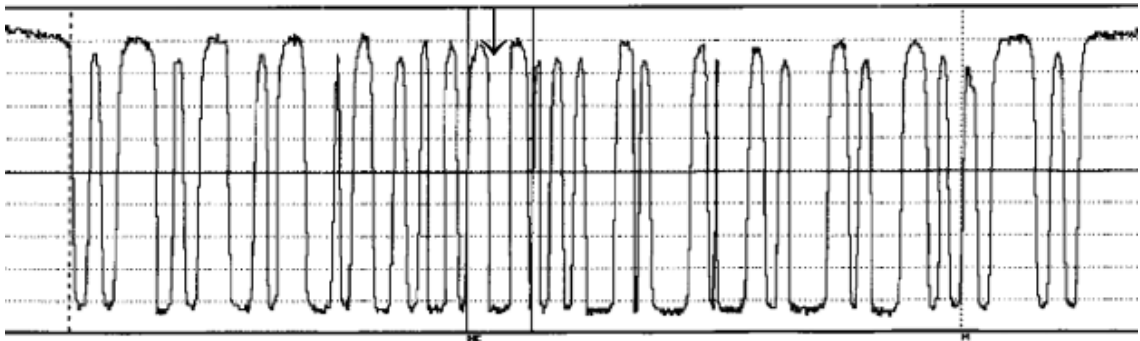

Defects, which show as irregularities in the Scan Reflectance Profile, may be caused by spots of extraneous ink in Quiet Zones or in the spaces. Small voids (white areas) in the bars are also highlighted as defects. In symbols printed on recycled or some other materials, local variations in reflectance of the background will also show as defects. The significance of a defect is in direct relation to the depth of the irregularity it causes in the Scan Reflectance Profile. Common causes and the most likely solutions include:

- Defective print head elements (thermal printing or ink-jet printing), which will tend to produce an unprinted line running through the symbol in the direction of printing: Clean or replace print head.
- Satellite (ink droplets in the white area surrounding the printed bars): Clean head; change ink formulation.
- Haloing (e.g., a double line impression where there should only be a single line impression): Adjust impression pressure and/or ink viscosity.
- Incorrect matching of thermal transfer ribbons and substrate (poor adhesion of ink to surface): Use correct ribbon for substrate; use smoother substrate.
- Measuring aperture too small: Use verifier with correct aperture.

The use of a smaller or larger measuring aperture than specified for the symbol will produce misleading defect grades and this is perhaps the strongest argument for ensuring that the right aperture size is used. Too small an aperture will exaggerate the apparent size of a defect; too large an aperture will tend to smooth it out.

Quiet Zones are a frequent source of scanning problems. Although the ISO standard does not directly require measurement of the Quiet Zones, it requires any additional requirements specified by the application specification to be graded on a pass/fail basis. These *GS1 General Specifications* establish Quiet Zone requirements for all symbols used in the GS1 system and a Quiet Zone less than the minimum width will, therefore, cause the profile grade to fail. Possible causes of Quiet Zone failure and the remedies are:

- Printed box surrounding symbol or other interfering print: Enlarge box; ensure symbol registration to other print allows adequate margins; use Quiet Zone Indicators if possible.
- Symbol too close to label edge: Adjust label feed; reposition symbol farther from edge; use larger label size or smaller symbol.

5.12.6 Print process characterisation techniques

5.12.6.1 Introduction

This section specifies when EAN/UPC symbols can be printed at less than the current minimum specification of 0.264 millimetres or 0.0104 inch X-dimension (80 percent magnification).

5.12.6.2 Background

Many printer users have asked if the magnifications in the 75 to 80 percent range for EAN/UPC symbols printed by thermal and laser on-demand printers are acceptable for use. The most common

printing densities used by on-demand, barcode printers are 200 and 300 dpi. However, due to the constraints of the dot pitch, these printers cannot print an 80 percent symbol correctly. The nearest to 80 percent that these printers can print is 75.7 or 76.9 percent depending on the exact dot geometry.

Even though 80 percent magnification is the minimum value specified in the EAN/UPC symbol specification, users of on-demand printers have used magnifications between 75 and 80 percent in point-of-sale scanning environments for years. They have done so with no significant reduction in scan rate, as compared to symbols printed precisely at 80 percent. Because larger in-specification EAN/UPC symbols are always easier to scan, 80 percent symbols and larger are preferred. However, when an on-demand printer is required, the 75 to 80 percent EAN/UPC symbols are an acceptable alternative given the conditions in section [5.12.6.3](#).

5.12.6.3 New qualifications for printing

The allowance for EAN/UPC symbol magnifications from 75 to 80 percent is only applicable to "on demand" (e.g., thermal or laser) print processes. For all other printing processes, 80 percent is attainable and is the minimum allowable size.

When printing a minimum symbol with any method of printing, the area provided for printing the symbol and the required Quiet Zone SHOULD never be less than the area required for an 80 percent symbol. This area is derived from the total width of an 80 percent symbol times its height as shown in the dimensions in the figure below.

When printing a minimum symbol with any method of printing, the symbol height SHOULD never be truncated below the 80 percent value (20.7 millimetres or 0.816 inch).

The minimum print quality grade SHOULD be the same for all EAN/UPC symbols; at least an ISO/ANSI grade of 1.5 (or C). It is advisable to print EAN/UPC symbols that are at least a 2.5 (B) grade at the time of printing regardless of size.

Figure 5.12.6.3-1. EAN/UPC symbol shown with minimum height and overall width dimensions for magnifications of 75 percent to 80 percent

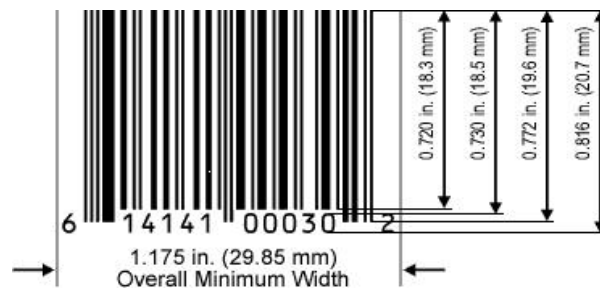

- 
Note: As you move from 80 to 75 percent magnification, the Quiet Zone increases from 0.094 inch (2.38 millimetres) to 0.124 inch (3.16 millimetres) in order to keep the overall width constant at 1.175 inches (29.85 millimetres).

5.12.6.4 Summary

When printing with on-demand printers (e.g., thermal or laser) the resulting element widths for EAN/UPC symbols SHALL NOT be less than 75 percent magnification. If the symbol printed with element widths is less than 80 percent, then the overall symbol SHALL have both larger Quiet Zones and taller bars such that the resulting area is not less than that of 80 percent magnification symbols. The symbol print quality must still meet the EAN/UPC symbol requirements of 1.5/06/660.

5.12.7 GS1 barcode verification template

5.12.7.1 Introduction

These GS1 barcode verification templates were developed in co-operation with retailers, manufacturers, logistic providers and equipment providers to ensure a common reporting approach on a global level. They help to ensure consistency regardless of where and by whom the barcodes are tested thus removing the costly and inefficient requirements for multiple testing of identical barcodes and reducing the cost of compliant equipment.

These templates do not introduce any requirements in and of themselves. The aim is to provide a common reporting format to measure compliance with the numbering and barcoding standards as well as HRI rules of GS1 laid down elsewhere in these *GS1 General Specifications*.

5.12.7.2 Background

GS1 has developed these verification templates on the basis of *ISO/IEC 15416 Information technology – Automatic identification and data capture techniques, Bar Code Print Quality Test Specifications for Linear Symbols* and *ISO/IEC 15415 Information technology – Automatic identification and data capture techniques – Bar code print quality test specification – Two dimensional symbols*. These templates allow for reporting the quality of printed barcodes but also checks against other key aspects of GS1 system (barcode placement, fit-for purposes, data integrity, etc.).



Note: The acceptance criteria are intended to ensure that barcodes adhere to all the requirements in the GS1 SSTs with an allowance for a small measurement variation.

A GS1 initiated Verifier Conformance Testing Project was conducted because of concerns expressed that different verifiers or verification services were unable to perform consistently. The perception was that different verifiers gave substantially different results when measuring the same barcode. A precisely defined test programme was performed under the auspices of GS1 and concluded that:

- All verifiers tested (each one ISO compliant) demonstrated the capability of consistent performance.
- Operators of verifiers require proper training and instruments require regular calibration in accordance with manufacturer recommendations.
- Most verifiers tested were capable of conforming to GS1 requirements.

It is therefore important to stress the need for professional verification services and that barcode print quality should be integral part of an overall quality programme. Section [5.12.3](#) provides a quick reference list of barcode quality specifications depending on the barcode type, the application, the syntax, printing method (e.g. direct printing) and the identification number .

All GS1 user companies should perform quality control of barcode production and most GS1 Member Organisations offer a verification service. These report templates may be used by any organisation or company as part of a quality programme while respecting the Copyright of the GS1 logo (or any heading or text that imply actual GS1 endorsement (subject to local licensing agreements such as accreditation programmes, which may allow exceptions)).

The two templates below highlight critical issues relating to verification and provide a common template for reporting on the most common areas of application. Note that an image of the barcode generated by the verifier is often provided along with the template information.



5.12.7.3 GS1 barcode verification template for linear barcodes

Example template:

<Name>	Issue date: <Date of issue>
<Line one address>	
<Line two address>	
<Town>	
<Postcode>	
Product Description:	<Brand and name of product>
Type of barcode:	<Barcode type detected>
Print method:	<Print method>
Number of barcodes on product:	<Number of barcodes>
Verifier device:	<Type/model>
Verification software version:	<Version>
Last verifier calibration date:	<Date>

Please Note: These assessments are based on meeting the minimum GS1 standards.
To ensure efficient scanning, the barcode should exceed the minimum.

Testing summary of the linear barcode

GS1 General Specifications for linear barcodes tested environments:	
PASS or FAIL when verified in accordance with GS1 symbol specification table _____ Note: Provide symbol specification table name and table number used from the <i>GS1 General Specifications</i> . If barcode is tested against more than one symbol specification table, one report should be provided for each table.	
Complies with GS1 barcode placement rules	Does/Does not comply with specification (& comment on business critical issue)
If multiple retail barcodes are present: Is the GS1 compliant two-dimensional barcode within a 50 mm radius from the centre of the linear POS barcode? (informative only)	Yes/No
ISO/IEC 15416 print quality grade	
Decoded text	
Business critical comments	

Technical analysis of the linear barcode

GS1 parameters	Comment reference	Assessed	Within standard range	Required	ISO/IEC parameters	Comment Reference	ISO/IEC grade 4:0 to 0:0	Within standard range	Required
Barcode structure					Overall ISO/IEC grade				
X-dimension (magnification)					Decode				
Barcode height					Symbol contrast				
Quiet Zone (left)					Minimum reflectance				
Quiet Zone (right)					Edge contrast				
Human readable					Modulation				
Barcode width					Defects				
Validity of GS1 Company Prefix					Decodability				
Data structure ¹ (syntax)					Print growth				
Educational comments ²									

(1) Data structure (syntax) indicates that the barcode is compliant with GS1 data syntax rules defined in the *General Specifications*.

(2) Educational comments are based on the technical analysis of the barcode. In this comment box the operator comments on what the problem is and how to make the symbol better.

Notes (informative localised)

It is the responsibility of the GS1 identification licensee to ensure the correct use of the GS1 Company Prefix and/or the individually licensed keys and the correct allocation of the data content.

Rejection of products should not necessarily be based only on an out of specification results

Barcode verifiers are measuring devices and are tools that can be used for assisting in quality control. The results are not absolute in that they do not necessarily prove or disprove that the barcode will scan.

This report may not be amended after issue. In the event of a dispute over contents the version held at [TESTING AGENCY] will be deemed to be the correct and original version of this report.

Notes (informative localised)

This Verification Report may contain privileged and confidential information intended only for the use of the addressee named above. If you are not the intended recipient of this report you are hereby notified that any use, dissemination, distribution or reproduction of this message is prohibited. If you received this message in error please notify [TESTING AGENCY].

Disclaimer (legal localised)

This report does not constitute evidence for the purpose of any litigation, and [TESTING AGENCY] will not enter into any discussion, or respond to any correspondence in relation to litigation.

Every possible effort has been made to ensure that the information and specifications in the Barcode Verification Reports are correct, however, [TESTING AGENCY] expressly disclaims liability for any errors.

5.12.7.4 GS1 barcode verification template for two-dimensional barcodes

Example template:

<Name>	Issue date: <Date of issue>
<Line one address>	
<Line two address>	
<Town>	
<Postcode>	
Product Description:	<Brand and name of product>
Type of barcode:	<Barcode type detected>
Print method:	<Print method>
Number of barcodes on product:	<Number of barcodes>
Verifier device	<Type/model>
Verification software version:	<Version>
Last verifier calibration date:	<Date>

Please Note: These assessments are based on meeting the minimum GS1 standards.
 To ensure efficient scanning, the barcode should exceed the minimum.

Testing summary of the two-dimensional barcode

GS1 General Specifications for two-dimensional barcodes, environments tested:	
PASS or FAIL when verified in accordance with GS1 symbol specification table _____	
Note: Provide symbol specification table name and number used from the <i>GS1 General Specifications</i> . If barcode is tested against more than one symbol specification table, one report should be provided for each table.	

Complies to GS1 barcode placement recommendations	In/out spec (& comment on business critical issue)
If multiple retail barcodes are present: Is the GS1 compliant two-dimensional barcode within a 50 mm radius from the centre of the linear POS barcode? (informative only)	Yes/No
Overall ISO/IEC 15415 print quality grade	

Decoded text
Business critical comments

Technical analysis of the two-dimensional barcode

GS1 parameters	Comment reference	Values	Compliant to standard	Required
Matrix size		NN X NN		
X-dimension/ cell size ¹		mm (inch)		
Data structure ² (syntax)				Dependent on structure encoded
Validity of GS1 Company Prefix				
Human readable				

ISO/IEC parameters	Comment reference	ISO grade 4.0 to 0.0	Compliant to standard	Required
Overall ISO/IEC grade				
Decode				
Symbol contrast				
Modulation				
Axial nonuniformity				
Grid nonuniformity				
Unused Error Correction				
Print growth (horizontal)				
Print growth (vertical)				
Fixed pattern damage				
Clock track and solid area regularity ⁴				
Quiet Zones (QZL1, QZL2) ⁴				
L1 and L2 ⁴				
Format information ⁵				
Version information ⁵				

Educational comments³:

- (1) X-dimension/cell size is the average of both the x dimension and y dimension of the cell
- (2) Data structure (syntax) indicates that the barcode is compliant with GS1 data syntax rules defined in the GS1 General Specifications or GS1 Digital Link URI Syntax standard.
- (3) Educational comments are based on the technical analysis of the barcode. In this comment box the operator comments on what the problem is and how to make the barcode better by explaining the parameter's meanings.
- (4) Data Matrix Only, see *ISO/IEC 16022*
- (5) QR Code Only, see *ISO/IEC 18004*

Notes (informative localised)

It is the responsibility of the GS1 identification licensee to ensure the correct use of the GS1 Company Prefix and/or the individually licensed keys the correct allocation of the data content.

Rejection of products should not necessarily be based only on an out of specification results

Barcode verifiers are measuring devices and are tools that can be used for assisting in quality control. The results are not absolute in that they do not necessarily prove or disprove that the barcode will scan.

This report may not be amended after issue. In the event of a dispute over contents the version held at [TESTING AGENCY] will be deemed to be the correct and original version of this report.

Important Note (normative localised)

This Verification Report may contain privileged and confidential information intended only for the use of the addressee named above. If you are not the intended recipient of this report you are hereby notified that any use, dissemination, distribution or reproduction of this message is prohibited. If you received this message in error please notify [TESTING AGENCY].

Disclaimer (legal localised)

This report does not constitute evidence for the purpose of any litigation, and [TESTING AGENCY] will not enter into any discussion, or respond to any correspondence in relation to litigation.

Every possible effort has been made to ensure that the information and specifications in the Barcode Verification Reports are correct, however, [TESTING AGENCY] expressly disclaims liability for any errors.

5.13 UHF and HF EPC/RFID

Radio Frequency Identification (RFID) is an acronym that covers many different technologies, all of which have the following two points in common:

- Data and all other additional protocol information are stored (in a binary format) in a microelectronic chip
- RFID tags communicate with dedicated readers by means of radio frequency waves or fields

These technologies classified by these main features:

- Passive or active
- The operating frequency band
- Batteryless or battery powered tags

It is worth noting that the choice of one of the available RFID technologies is globally independent from the data and identifiers that the RFID tags carry.

EPC/RFID is a subset of RFID technologies that are used within the GS1 system. There are two types of EPC/RFID data carriers optimised for different application requirements. Both are passive technologies and are designed to carry Electronic Product Codes (EPC) formats including GS1 identification keys and Application Identifiers.

- ✔ **Note:** EPC, Electronic Product Code, is designed to facilitate business processes and applications that need to manipulate visibility data – data about observations of physical objects. The EPC is a universal identifier that provides a unique identity for any physical object. The EPC is designed to be unique across all physical objects in the world, over all time and across all categories of physical objects. It is expressly intended for use by business applications that need to track all categories of physical objects, whatever they may be. There is a well-defined correspondence between EPCs and GS1 keys. This allows any physical object that is already identified by a GS1 key (or GS1 key + serial number combination) to be used in an EPC context where any category of physical object may be observed. Likewise, it allows EPC data captured in a broad visibility context to be correlated with other business data that is specific to the category of object involved and which uses GS1 keys. For more information, see: [EPC Tag Data Standard](#).

The first type, UHF EPC/RFID, works in the UHF (Ultra High Frequency) bands and is defined in the "[EPC Radio-Frequency Identity Protocols Generation-2 UHF RFID Standard, Specification for RFID Air Interface Protocol for Communications at 860 MHz – 960 MHz](#)". This standard has established itself as the backbone for UHF RFID implementations across multiple sectors.

The second type, HF EPC/RFID, works in the HF (High Frequency) band and is defined in the "[EPC Radio-Frequency Identity Protocols EPC Class-1 HF RFID Air Interface Protocol for Communications at 13.56 MHz](#)".

- ✔ **Note:** For reasons of simplicity, since UHF EPC/RFID is much more widely used than HF EPC/RFID, simple reference to EPC/RFID usually means UHF EPC/RFID.
- ✔ **Note:** Air interface protocol standard defines the way readers and tags make use of a dedicated frequency band of the radio spectrum to communicate. It also defines a set of standardised commands and responses.

For encoding and decoding procedures and technical specifications related to the management of EPC/RFID Tags memory banks, the GS1 General Specifications make normative reference to GS1's [EPC Tag Data Standard](#).

Complementing TDS and EPC/RFID Air Interface protocols, other GS1 standards related to the implementation and use of EPC/RFID can be found at: <https://www.gs1.org/standards/epc-rfid>

6 Barcode placement

6.1 Introduction

This section includes guidelines for the placement of barcodes on packages and containers. It gives the general principles that apply, mandatory rules and recommendations for barcode placement on specific packaging and container types. Additionally, this includes placement rules for transitioning from a linear barcode to a 2D barcode for general retail.

Consistency of barcode placement is critical to successful scanning. With manual scanning, variation of barcode placement makes it difficult for the scanning operator to predict where the barcode is located and this reduces efficiency. With automated scanning, the barcode must be positioned so that it will pass through the field of vision of a fixed scanner as it travels past. Respecting the guidance in this section will result in the consistency and predictability required.

The guidelines in this global specification replace previous local recommendations; however, manufacturers should not scrap packaging that has been printed according to previous guidelines. When packaging is redesigned, the global specifications in this document SHALL be observed. If government regulatory guidelines are inconsistent with those in this manual, the government guidelines should always take precedence.

 **Note:** Barcodes in this guideline that are used as examples are “for position only” and are not intended to denote correct barcode type, size, colour, or quality.

6.2 General placement principles

The following general principles for barcode placement shall be considered for any package type, whether it is scanned at the point-of-sale (POS) or a general distribution scanning environment. Trade items intended to be scanned at a POS SHALL be marked with an EAN-13, UPC-A, EAN-8, UPC-E, GS1 DataBar Omnidirectional, GS1 DataBar Stacked Omnidirectional, GS1 DataBar Expanded or GS1 DataBar Expanded Stacked barcode. During the 2D transition period, a GS1 DataMatrix, Data Matrix (GS1 Digital Link URI) or QR Code (GS1 Digital Link URI) may be applied to trade items scanned at retail POS, in addition to the linear barcode. For further information on the conformance requirements for future use of 2D barcodes at retail POS, please refer to the Application Standard Profiles in section [8](#).

The barcodes that are scanned in general distribution scanning environments are EAN-13, UPC-A, ITF-14, GS1 DataBar family and GS1-128 barcodes

EAN-8 and UPC-E barcodes are intended for use on very small trade items sold at POS (see section [2.1.3](#)).

6.2.1 Number of barcodes

Barcodes representing different Global Trade Item Numbers (GTINs) must never be visible on any one item. Although a minimum of one barcode is required, two barcodes representing the same GTIN are recommended on trade items for scanning in warehousing or general distribution scanning environments (see section [6.7](#)). Two or more barcodes representing the same GTIN are recommended on large, heavy, or bulky items for POS (see section [6.4.9](#)) and are permissible on random wraps intended for POS (see section [6.3.3.7](#)). Two barcodes may be required during the 2D barcode transition period (see section [4.15](#) for multiple barcodes). For a summary of all conformance requirements for AIDC application standards, 2D barcodes, cross-application rules and related technical specifications, see section [8](#).

6.2.2 Scanning environment

Before considering the package type, determine whether the item will be scanned in a POS or a general distribution scanning environment. If the item is scanned at a POS only, the barcode placement guidelines in sections [6.3](#), [6.4](#), [6.5](#) and [6.5.5](#) apply. However, if the item is scanned in both a point-of-sale and general distribution scanning environment or in a general distribution

scanning environment only, the requirements barcode placement rules in section [6.7](#) take precedence.

6.2.3 Orientation

Barcode orientation is determined primarily by the print process and any curvature of the item. If the printing process and curvature allow, the preferred placement is picket fence orientation, in which the bars of the barcode are perpendicular to the surface on which the package stands in its normal display position. For human readable interpretation rules see section [4.14](#). Empirical data has demonstrated that it makes no difference to the scanning process one way or the other. Rules for positioning barcodes on curved surfaces are given in section [6.2.3.2](#).

Figure 6.2.3-1. Barcode orientation

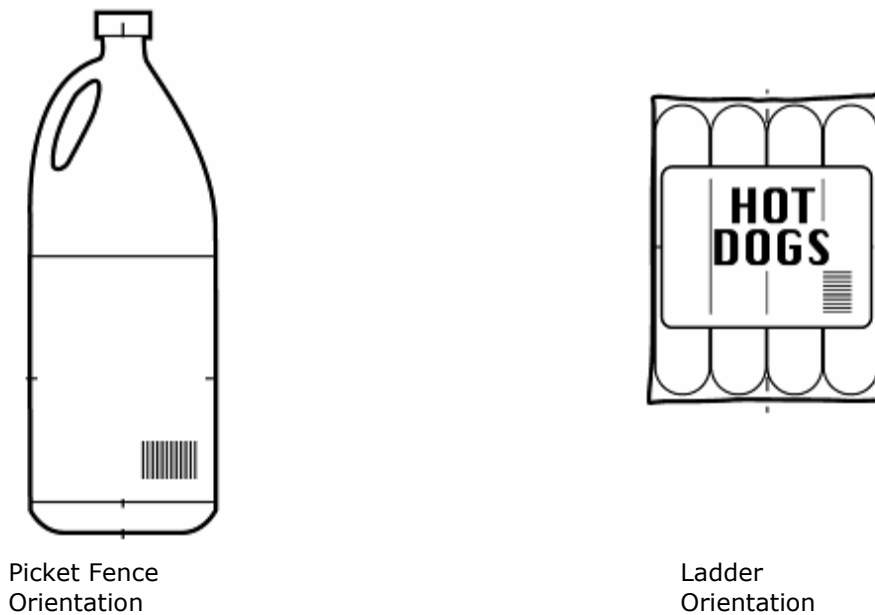

6.2.3.1 Printing direction

Barcode orientation is often determined by the printing process. Some printing processes give much higher quality results if the bars of the barcode run in the direction of the print, also known as the web direction. The printing company should always be consulted.

6.2.3.2 Trade items with curved surfaces

When a barcode is printed onto a curved surface it is sometimes possible for the extremes of the barcode to disappear around the curve, so that both ends cannot be visible to the scanner at the same time. This is more likely to occur the bigger the barcode and the tighter the curve of the packaging. In these situations, linear barcodes **SHALL** be printed using certain combinations of the X-dimension and diameter of the curved surface (e.g., in ladder orientation on a can, in picket fence orientation on a cylindrical packet of biscuits). This helps ensure that the curve results in an apparent loss of height of the bars rather than the more serious apparent loss of complete bars.

Figure 6.2.3.2-1. Barcode placement on curved surfaces



Ladder orientation
(Preferred for all curve surfaces)



Picket Fence orientation (avoid on tightly curved surfaces)

The angle between the tangent to the centre of the curved barcode and the tangent to the extremity of the curved barcode (outer edge of the guard bars for barcodes in the EAN/UPC symbology) must be less than 30 degrees. If this angle is more than 30 degrees, the barcode must be oriented such that the bars are perpendicular to the generating lines of the surface of the item.

Figure 6.2.3.2-2. Relationship between symbol and curvature

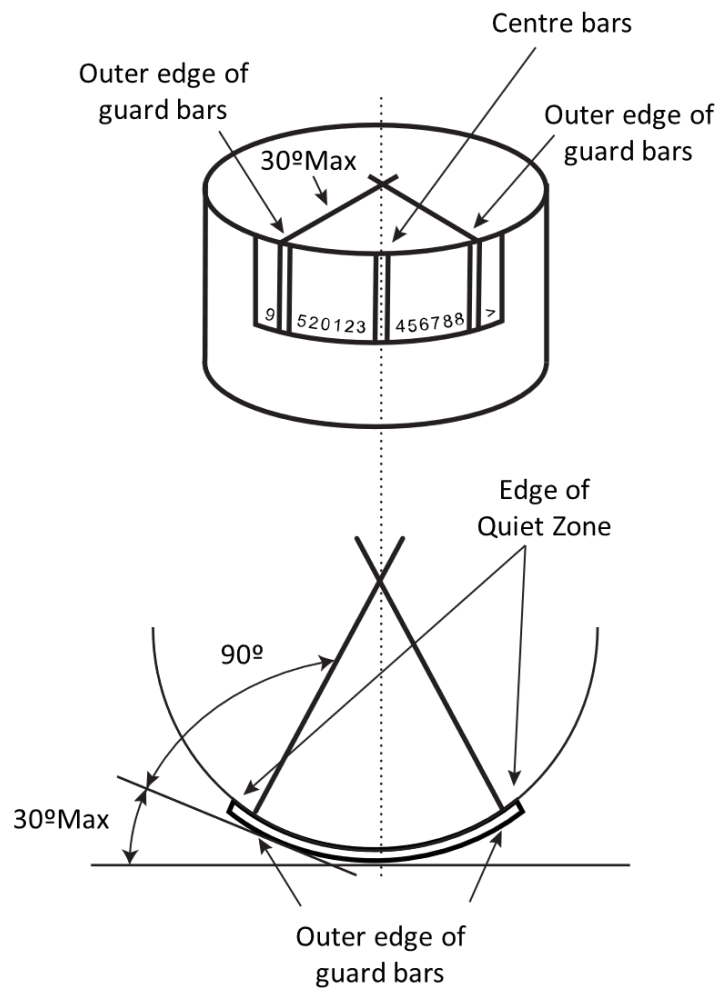

Figures 6.2.3.2-3 and 6.2.3.2-4 show the relationship between acceptable X-dimensions (narrow element width) for units of different diameters and the minimum diameters for different X-dimensions for barcodes printed in the picket fence orientation. Please refer to section 5.12 for the minimum, target and maximum X-dimension for the barcode, based on the scanning environment.

Figure 6.2.3.2-3. Relationship between diameter and the X-dimension

Diameter of container		Maximum Value of X-dimension			
		EAN-13 or UPC-A barcode		EAN-8 barcode	
mm	inches	mm	inches	mm	inches
s30 or below	1.18 or below	*	*	*	*
35	1.38	*	*	<i>(0.274)</i>	<i>(0.0108)</i>
40	1.57	*	*	<i>(0.314)</i>	<i>(0.0124)</i>
45	1.77	*	*	0.353	0.0139
50	1.97	<i>(0.274)</i>	<i>(0.0108)</i>	0.389	0.0153
55	2.16	<i>(0.304)</i>	<i>(0.0120)</i>	0.429	0.0169
60	2.36	0.330	0.0130	0.469	0.0185
65	2.56	0.356	0.0140	0.508	0.0200
70	2.75	0.386	0.0152	0.549	0.0216
75	2.95	0.413	0.0163	0.587	0.0232
80	3.25	0.446	0.0174	0.627	0.0247
85	3.35	0.469	0.0185	0.660	0.0260
90	3.54	0.495	0.0195	0.660	0.0260
95	3.74	0.525	0.0207	0.660	0.0260
100	3.94	0.551	0.0217	0.660	0.0260
105	4.13	0.578	0.0228	N/A	N/A
110	4.33	0.607	0.0239	N/A	N/A
115	4.53	0.634	0.0250	N/A	N/A
120 or above	4.72	0.660	0.0260	N/A	N/A

- 
Note: An asterisk (*) indicates that the package diameter is too small to permit a picket fence orientation barcode and the barcode must be rotated 90 degrees to a ladder orientation (see section 5.12) The barcode is printed perpendicular to the generating lines of the surface of the container.

- 
Note: *Italics* indicate X-dimensions that are permissible, but are not recommended on curved surfaces.

- 
Note: EAN-8 barcodes are reserved for very small items (see section 2.1).

Figure 6.2.3.2-4. Relationship between the X-dimension and diameter

X-dimension		Minimum diameter of container					
		EAN-13 or UPC-A barcode		EAN-8 barcode		UPC-E barcode	
mm	inches	mm	inches	mm	inches	mm	inches
0.264	0.0104	48	1.89	34	1.33	26	1.01
0.300	0.0118	55	2.14	38	1.51	29	1.51
0.350	0.0138	64	2.50	45	1.76	34	1.53
0.400	0.0157	73	2.86	51	2.02	39	1.54
0.450	0.0177	82	3.21	58	2.27	44	1.73
0.500	0.0197	91	3.57	64	2.52	49	1.92
0.550	0.0217	100	3.93	70	2.77	54	2.11
0.600	0.0236	109	4.29	77	3.02	59	2.31
0.650	0.0256	118	4.64	83	3.27	63	2.50
0.660	0.0260	120	4.72	85	3.35	64	2.54

6.2.3.3 Avoiding scanning obstacles

Anything that will obscure or damage a barcode will reduce scanning performance and SHALL be avoided. For example:

- Never position the barcode on the item in an area with inadequate space. Do not let the other graphics encroach on the space for the barcode.
- Never place barcodes, including Quiet Zones, on perforations, die-cuts, seams, ridges, edges, tight curves, folds, flaps, overlaps and rough textures.
- Never put staples through a barcode or its Quiet Zones.
- Never fold a barcode around a corner.
- Never place a barcode under a package flap.
- Barcodes used for production control purposes SHOULD be obstructed wherever possible before entering general distribution (see section [4.15.](#))

6.3 General placement guidelines for point-of-sale (POS)

This section outlines the guidelines for barcode placement on trade items that will be scanned at POS. For detailed information on specific package types, see sections [6.4](#), [6.5](#) and [6.5.5](#). Section [6.7](#) outlines guidelines for barcode placement on trade items that will be scanned in warehousing or general distribution scanning environments.

6.3.1 Number of barcodes

At least one barcode is needed on a trade item intended for POS. Exceptions include large, heavy, or bulky items (see section [6.4.9](#)) and random or unregistered wrapping (see section [6.3.3.7](#)) where two or more barcodes with the same Global Trade Item Number (GTIN) may be required. During the 2D transition period, the 2D barcode may also be applied in addition to the linear barcode. When there is more than one barcode with GTIN on trade items, it is essential that the POS systems will ensure:

- The system SHALL only process one set of the desired data in the final transaction.
- Scanning systems SHOULD only produce one acknowledgement (e.g., beep) when multiple barcodes are scanned from the same trade item.

 **Important:** If the points above are not implemented unintended POS transactions may occur.

Trade items SHALL NOT have two or more barcodes encoding different Global Trade Item Numbers (GTINs). At the POS, this is particularly relevant with multipacks, such as over-wrapped items, sleeved items and banded items, where the individual inner units carry a different GTIN from that on the outer wrapper or container. The barcodes on the inner products must be totally obscured so that they cannot be read by the POS system. (See section [6.3.3.7](#) for over-wrap special considerations.)

6.3.2 Identifying the back of the trade item

The front of the trade item is the primary trading/advertising area, which typically displays the product name and the company's logo. The back of the trade item is directly opposite the front and is the preferred placement area for the barcode on most trade items.

6.3.3 Barcode placement

Information in this section is provided to guide barcode placement when developing packaging for new products and should be adopted when changing the graphics of existing products.

6.3.3.1 Preferred placement

Preferred barcode placement is on the lower right quadrant of the back, respecting the proper Quiet Zone areas around the barcode and the edge rule (see the edge rule in section 6.3.3.3 and special considerations in section 6.3.3.7).

When a linear barcode and a 2D barcode are both being used for retail POS applications, the entire 2D barcode including Quiet Zones SHOULD be placed within a 50 millimetre (2 inch) radius from the centre of the linear barcode.

- Important:** If the 2D barcode is outside of the 50 millimetre (2 inch) radius of the linear barcode, the scanning system may not identify that both barcodes are related to the same trade item.

Figure 6.3.3.1-1 2D barcode placement in relation to the linear barcode



Figure 6.3.3.1-2. 2D barcode placement in relation to the linear barcode example

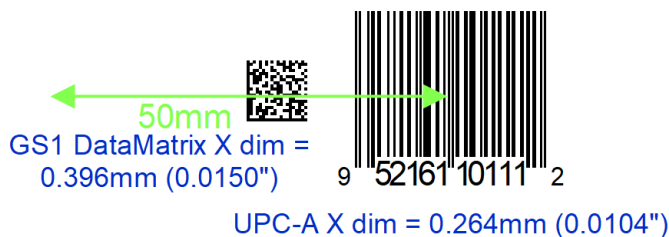

Figure 6.3.3.1-3. Hang tag 2D barcode placement in relation to the linear barcode example



Figure 6.3.3.1-4. Maximum POS X-dimension 2D barcode placement in relation to the linear barcode example



Note: Larger barcodes can appear on trade items, such as cereal boxes, dog food bags and may exceed the recommended 50 millimetre (2 inch) radius. The linear barcode and 2D barcode separation SHOULD be kept as minimal as possible and SHALL respect the quiet zones.

6.3.3.2 Alternative placement

The alternative placement for a barcode is the lower right quadrant of any surface of the container other than the back.

6.3.3.3 Edge rule

When possible, the barcode must not be closer than 8 millimetres (0.3 inch) or farther than 100 millimetres (4 inches) from the nearest edge of the package/container. Previous guidelines suggested a distance of 5 millimetres (0.2 inch) as a minimum. Practical experience has shown this to be inadequate. For example, cashiers often grab the edges of bags and other trade items with their thumbs. Avoid placing the barcode too close to the edge. Such placement reduces efficiency at the POS.

6.3.3.4 Avoid truncated linear barcodes

Truncation of a linear barcode is the reduction of the height of a barcode relative to its length. Truncation is not recommended because it destroys the ability of a barcode to be scanned omnidirectionally at the POS. A truncated linear barcode can only be scanned when the trade item is oriented in particular directions across the scanning beam. Truncation, therefore, reduces checkout efficiency. The more the height of the barcode is reduced, the more critical becomes the alignment of the linear barcode across the scanning beam. Truncation SHALL be avoided unless absolutely necessary (e.g., when printing on a tightly curved surface) and then the maximum height possible SHALL be printed. See section [6.2.3.2](#) for rules on the relationship between the diameter of the item and the X-dimension.

6.3.3.5 Bottom marking

Bottom marking of the trade item with the barcode continues to be acceptable, except for large, heavy, or bulky trade items. However, back (side) marking is preferred.

6.3.3.6 Exceptions to the general placement guidelines

Some trade items require special considerations for barcode placement.

- Bags

When bag contents settle, the bag edges can bulge to the extent that barcodes located on the lower right quadrant may not be flat enough to permit successful scanning. For this reason, barcodes on bags SHOULD be placed in the centre of the back about one third up from the bottom and as far from the edge as possible while respecting the edge rule. (See section [6.4.1](#) for more details on bags.)

- Blister packs or unpackaged items

Trade items that cause scanners to read beyond the flat plane include blister packs and unpackaged items (e.g., deep bowls). For these items, the distance between the scanner window and the barcode on the container or item must be considered. The barcode must not be closer than 8 millimetres (0.3 inch) or farther than 100 millimetres (4 inches) from any edge of the package/container. (See sections [6.4.2](#) and [6.4.16](#) for more details on blister packs and unpackaged items.)

- Large, heavy, or bulky items

Any package/container weighing more than 13 kilograms (28 pounds) or having two dimensions greater than 450 millimetres (18 inches) (width/height, width/depth, or height/depth) is considered a large, heavy, or bulky item. Large, heavy, or bulky items tend to be hard to handle. Large, heavy, or bulky items may require more barcodes in multiple locations (see section [6.4.9](#) for more details on large, heavy, or bulky items.)

- Thin items or containers

Thin items or containers are packages/containers with a dimension less than 25 millimetres (1 inch) (height, width, or depth). Examples of thin items or containers are packages of pizza, powdered drink mixes and writing pads. Any placement of the barcode on the edge hinders effective scanning because the barcode is obscured from the cashier and is likely to be truncated. (Refer to section [6.4.12](#) for more details on thin items or containers.)

6.3.3.7 Special packaging considerations for barcode placement

Some packaging methods require special considerations for barcode placement.

Over-wrap

Trade items sold in multiples are mechanically gathered and covered with clear over-wrap material that will carry print. Typical over-wrapped items are small cereal boxes and chocolate bars. Package over-wrap can create two distinct problems:

- Obscuring the barcodes on individual units inside the multipack is necessary so they are not confused with the outer multipack barcode, which SHALL have different GTINs.
- Over-wrapping with such materials as cellophane causes diffraction or reflection of the light beam of the scanner and can reduce contrast, which causes scanning inefficiencies.

To determine proper barcode placement for over-wrapped packaging, follow the guidelines specific to the applicable package type/shape. (See section [6.4](#) for details on barcode placement for specific package types.)

Figure 6.3.3.7-1. Barcode placement on over-wrapped item

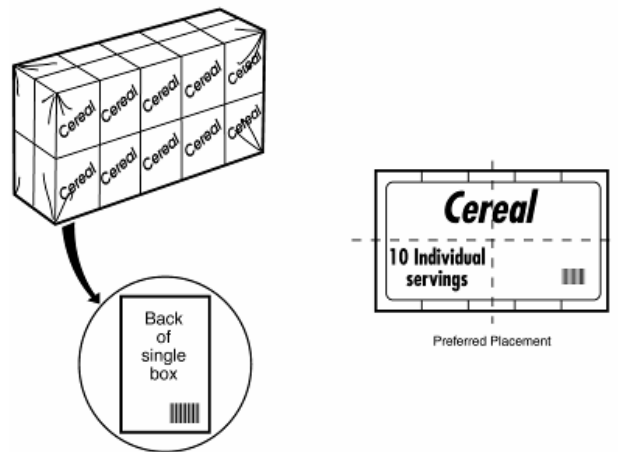

Random (unregistered) wrap

Some wrappers, like those used on sandpaper or margarine, have a repeating design and are neither cut nor placed on the product such that a particular part of the design always appears in the same location. This is referred to as random or unregistered wrapping. As the wrapper is not registered, it is unlikely that the barcode will appear on one face of the package when the wrapper is placed on the product.

The presence of more than one barcode on a package can have a detrimental effect on scanning productivity and, more importantly, can lead to a double read. For this reason, it is essential that the POS systems be updated to only process one set of the desired data in the final transaction or the use of registered packaging is preferred for random wrap. If random wrap must be used, the minimum requirement is to print the barcode with sufficient frequency so that a full barcode will appear on one package face.

If any additional barcodes are outside of the 50 millimetres (2 inches) radius from the centre of the linear barcode, the scanning system may not identify that both barcodes are related to the same trade item.

Consideration should also be given to elongating the bars of the barcode to ensure a full barcode on one face, instead of repeating the barcode.

Figure 6.3.3.7-2. Barcode placement on random-wrapped item



Shrink film/vacuum-formed packages

The barcode on an item packaged in shrink film or that is vacuum-formed SHALL be located on a flat surface and in an area free of creases, wrinkles, or other types of distortions. Refer to figure [6.3.3.7-3](#), which shows barcode placement on hot dogs. Since the curvature of the hot dogs was greater than the diameter shown within the section [6.2.3.2](#) figures, a ladder orientation barcode was used.

To determine proper barcode placement for shrink film/vacuum-formed packaging, follow the guidelines specific to the applicable package type/shape. (Refer to section [6.4](#) for details on barcode placement for specific package types/shapes.)

Figure 6.3.3.7-3. Barcode placement on shrink film/vacuum-formed item

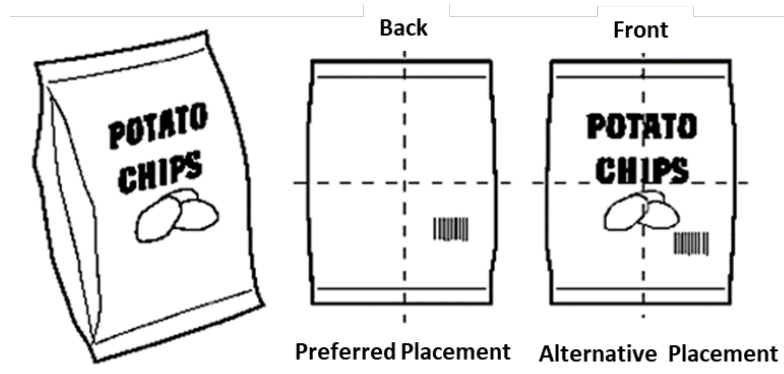

Spot labels

Barcodes printed on spot labels that are applied to the trade item are acceptable alternatives that incorporate barcodes into existing packaging graphics or for use on items without packages, such as some pots, pans, tableware and glassware. The most suitable type of spot label is one that cannot be removed from the item without destroying the barcode. Labels that are applied directly to the product should use an adhesive that is strong enough to adhere to the label for an extended shelf life, but which also allows the label to be removed without the use of solvents or abrasives.

To determine proper barcode placement on items bearing spot barcode labels, follow the guidelines specific to the applicable package type/shape. (Refer to section [6.4](#) for details on barcode placement for specific package types.)

Figure 6.3.3.7-4. Barcode placement with a spot label



Figure 6.3.3.7-5. Tableware items using barcode spot labels

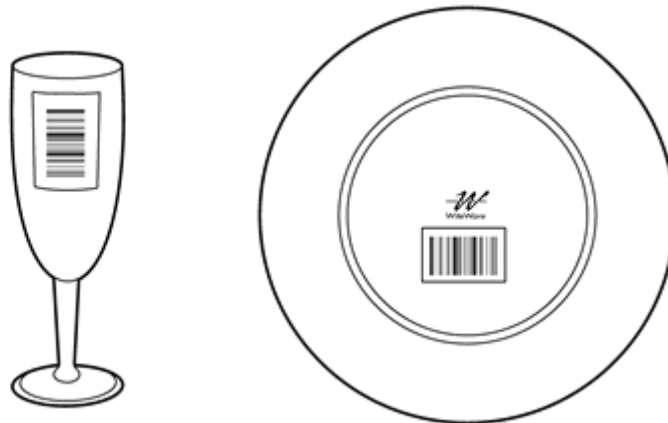

6.3.3.8 Operational considerations of barcode placement

Speed, efficiency and effectiveness in scanning operations are the ultimate goals of proper barcode placement. To ensure that scanning performance will not be compromised, consider the following matters before deciding on final barcode placement:

- **Consistent barcode location:** Compare your package/container to packaging for like products to ensure equivalent barcode placement. The ease with which barcodes are located by a cashier from product to product essentially relies on consistent barcode placement.
- **Scan simulation (hand motion effectiveness):** Pass the barcode across the scanner with your hand to test the initial barcode placement. This test is intended to confirm that the barcode placement does not necessitate unnatural hand motions while you are scanning the barcode.

6.3.3.9 Security tag placement

When a visible security tag is used, the preferred placement is within a 75 millimetres (3 inches) diameter of the barcode placement. Consistent security tag placement makes it easier for the operator to predict security tag location and, thus, improves scanning efficiency.

6.4 Placement guidelines for specific package types

The following barcode placement guidelines apply to specific package types. Section [6.5](#) contains diagrams illustrating barcode placement for clothing and fashion accessories. Figure [6.4-1](#) *Package*

type reference describes the main packaging categories and products. This figure can be used to determine correct barcode placement by product or packaging. For example, according to the figure below, a package of flower seeds in a 50 millimetres (2 inches) by 75 millimetres (3 inches) by 2 millimetres (0.07 inch) envelope is classified as a thin item or container. The example given of this type of package is powdered soft drink mix. According to the first column of the *Package type reference*, the correct barcode placement for this package type is determined by looking at section [6.4.12](#).

Figure 6.4-1. Package type reference

Section	Package type	Package characteristics	Product examples
6.4.1	Bags	Sealed cylindrical or rounded-corner wrapped units	Potato chips, flour, sugar, bird seed
6.4.2	Blister packs	Flat card backing a formed clear plastic bubble placed over product	Toys, hardware parts
6.4.3	Bottles and jars	Small or large-mouth vessels sealed with removable lids	Barbecue sauce, fruit jelly
6.4.4	Boxes	Folded, sealed, heavy paper or corrugated cardboard cartons	Crackers, cereal, detergent
6.4.5	Cans and cylinders	Cylindrical-shaped units sealed at each end	Soups, drinks, cheese, biscuits
6.4.6	Carded items	Items mounted or sealed on flat cards	Hammers, parcels of candy, kitchen utensils
6.4.7	Egg cartons	Irregular hexahedrons of plastic or moulded pulp with hinged lids	Eggs
6.4.8	Jugs	Glass or plastic vessel with built-in handle(s) and removable lid(s)	Household cleaners, cooking oil
6.4.9	Large, heavy, bulky items	Items having physical dimension of 450 mm (18 in.) or more in any two dimensions and/or weight in excess of 13 kg (28 lb)	Pet food, unassembled furniture, sledge hammers
6.4.10	Multipacks	Multiple items mechanically bound to create one package	Soft drink cans
6.4.11	Publishing items	Printed paper media that is bound, stapled, or folded	Books, magazines, newspapers, tabloids
6.4.12	Thin items or containers	Items or containers with one dimension less than 25 mm (1 in.)	Boxes of pizza, CD jewel boxes, powdered soft drink mix packages, writing pads
6.4.13	Trays	Flat, formed receptacles holding product covered with over-wrap	Prepared meats, pastries, snacks, pies, pie crusts
6.4.14	Tubes	Firmly packed cylinders sealed at both ends, or sealed at one end with a cap or valve on the other end	Toothpaste, sausage, caulk
6.4.15	Tubs	Deep vessels with removable lids	Margarine, butter, ice cream, whipped cream
6.4.16	Unpackaged	Trade items that have no packaging, are often of an unusual shape and are hard to label and scan	Frying pans, mixing bowls, cooking pots, giftware
6.4.17	Sets	Trade items that can be sold individually or as part of a boxed set.	Table and giftware
6.4.18	Sporting goods	Unpackaged items of specific size and shape.	Racquets, skis, skateboards

6.4.1 Bags

Although this category is referred to as “bags,” these packages/containers are often called sacks or pouches. This category includes paper or plastic containers that are:

- Fold-sealed on both ends (e.g., flour, sugar).

- Fold-sealed on one end and pinched sealed at the other end (e.g., potato chips).
- Pinch-sealed at both ends (e.g., cough drops).
- Fold-sealed on one end and gathered at the other end (e.g., bread).
- ✔ **Note:** Some bags are sealed at both ends and carded for display, such as bags of sweets. These types of items are not considered bags but fall into the carded items category. (See section [6.4.6](#) for details on carded items.)
- Package characteristics: Sealed cylindrical or rounded-corner wrapped units
- Unique considerations: Bags have a tendency to have contents that shift and bulge. Consequently, barcode placement must be on an area of the bag that is most likely to remain flat.
- Barcode placement: Identify the front of the package/container. (See section [6.3.2](#) for instructions on how to identify the package front):
 - Preferred placement: On the lower right quadrant of the back and away from the edge, respecting the proper Quiet Zone areas around the barcode.
 - Alternative placement: On the lower right quadrant of the front and away from the edge, respecting the proper Quiet Zone areas around the barcode.
 - Edge rule: See section [6.3.3.3](#).

Figure 6.4.1-1. Barcode placement on bags

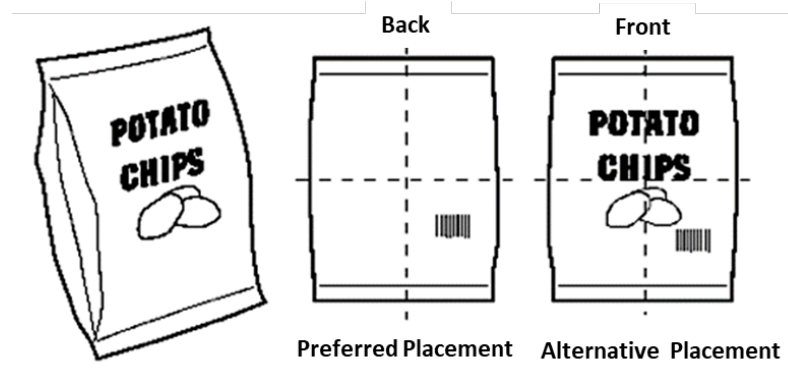

6.4.2 Blister packs

Blister packs are pre-formed clear plastic bubbles, or blisters, containing a product and backed or topped with card stock.

- Package characteristics: flat card, backing a formed clear plastic bubble placed over the product.
- Unique considerations: to ensure quality scanning, the barcode must be clear of the blister edges. Avoid placing the barcode under the blister pack or placing the barcode over any perforations on the back of the package.
- Barcode placement: identify the front of the package/container. (Refer to section [6.3.2](#) for instructions on how to identify the package front):
 - Preferred placement: on the lower right quadrant of the back, near the edge, respecting the proper Quiet Zone areas around the barcode.
 - Alternative placement: on the lower right quadrant of the front, near the edge, respecting the proper Quiet Zone areas around the barcode.
 - Edge rule: See section [6.3.3.3](#).

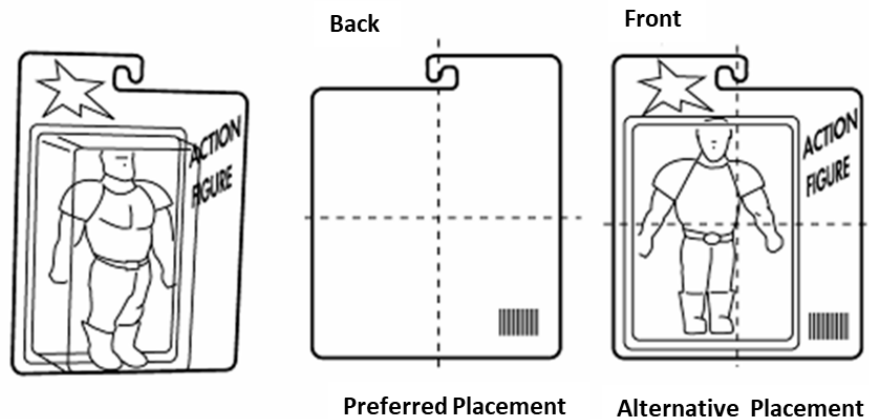
Figure 6.4.2-1. Barcode placement on blister packs

6.4.3 Bottles and jars

Bottles and jars normally carry spot labels applied to confined areas of the package, not covering the entire surface or wrapping around the entire perimeter.

- Package characteristics: Small or large-mouth containers sealed with removable lids.
- Unique considerations: Application of the barcode to the neck of a bottle is not allowed. Barcode placement on the neck of the bottle necessitates additional handling at the POS, and space limitations on this area of the bottle usually result in barcode truncation.

When a barcode is printed onto a curved surface it is sometimes possible for the extremes of the barcode to disappear around the curve. See section [6.2.3.2](#) for rules on the relationship between the diameter of the item and the X-dimension.

- Barcode placement: Identify the front of the package/container. (Refer to section [6.3.2](#) for instructions on how to identify the package front):
 - Preferred placement: On the lower right quadrant of the back, near the edge, respecting the proper Quiet Zone areas around the barcode.
 - Alternative placement: On the lower right quadrant of the front, near the edge, respecting the proper Quiet Zone areas around the barcode.
 - Edge rule: See section [6.3.3.3](#).

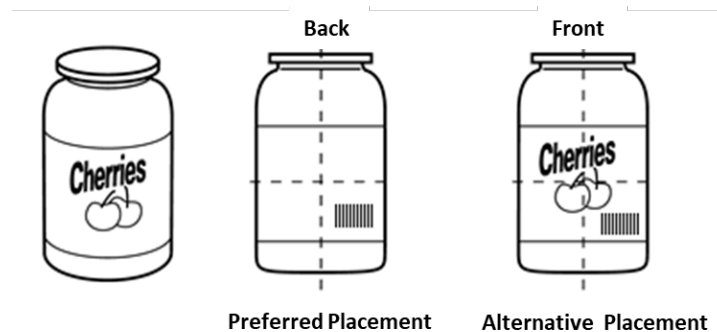
Figure 6.4.3-1. Barcode placement on bottles and jars

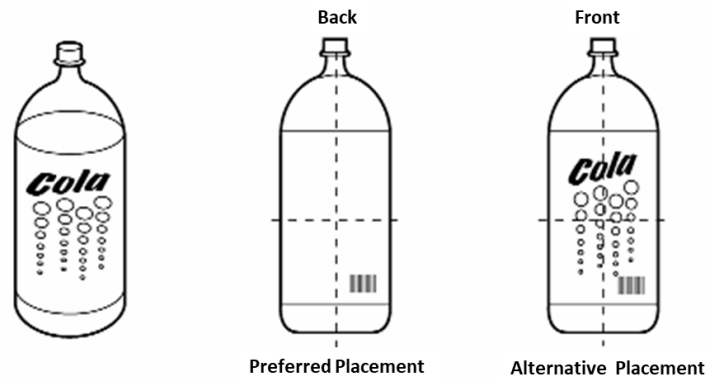

6.4.4 Boxes

This package type includes cuboid or cylindrical card or plastic cartons, as well as rectangular sleeves (used for products such as light bulbs). These packages might contain anything from crackers or cereal to detergent.

- Package characteristics: Folded, sealed, heavy paper or corrugated cardboard cartons.
- Unique considerations: There are no unique considerations that apply to this package type.
- Barcode placement: Identify the front of the package/container. (Refer to section [6.3.2](#) for instructions on how to identify the package front):
 - Preferred placement: On the lower right quadrant of the back, near the edge, respecting the proper Quiet Zone areas around the barcode.
 - Alternative placement: On the lower right quadrant of the front, near the edge, respecting the proper Quiet Zone areas around the barcode.
 - Edge rule: See section [6.3.3.3](#).

Figure 6.4.4-1. Barcode placement on boxes

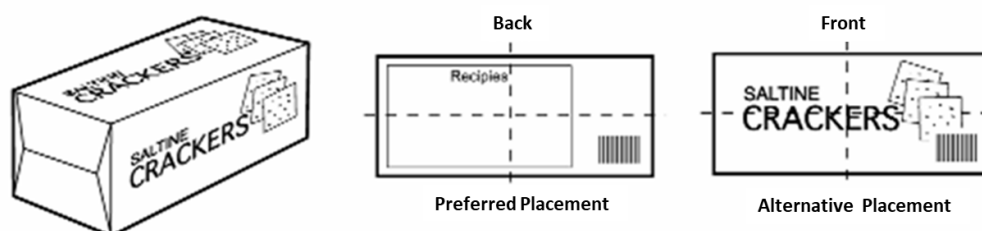

6.4.5 Cans and cylinders

This category includes cylindrical shaped containers (usually made of plastic or metal) that are sealed at each end. Some containers have removable lids or openings. Common examples are canned fruit and vegetables, paints and adhesives.

- Package characteristics: Cylindrical-shaped units sealed at each end.
- Unique considerations: Obstacles, such as beading, seams and/or ridges on the package/container SHALL be avoided, because they will reduce scanning performance. When a barcode is printed onto a curved surface it is sometimes possible for the extremes of the barcode to disappear around the curve. See section [6.2.3.2](#) for rules on the relationship between the diameter of the item and the X-dimension.
- Barcode placement: Identify the front of the package/container. (Refer to section [6.3.2](#) for instructions on how to identify the package front):

- Preferred placement: On the lower right quadrant of the back, near the edge, respecting the proper Quiet Zone areas around the barcode.
- Alternative placement: On the lower right quadrant of the front, near the edge, respecting the proper Quiet Zone areas around the barcode.
- Edge rule: See section [6.3.3.3](#).

Figure 6.4.5-1. Placement on cans and cylinders

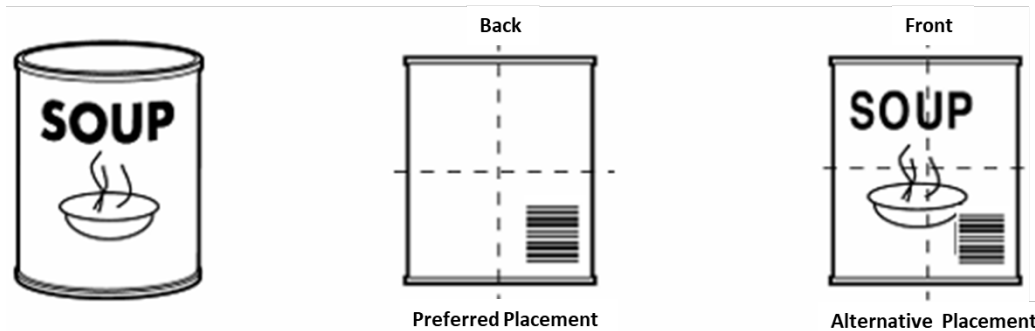

6.4.6 Carded items

Small, loose, or non-packaged items that are difficult to label are placed on cards that are marked with a barcode. Examples include hammers, toys and kitchen utensils.

- Package characteristics: Items mounted or sealed on flat cards.
- Unique considerations: When placing barcodes on carded items, it is important to take into consideration the proximity of the barcode to the product. Be sure to allow adequate space for the barcode, avoiding any obstructions that might be caused by placing the barcode too close to the product. In addition, do not place the barcode over any perforations or other obstructions on the package.
- Barcode placement: Identify the front of the package/container. (Refer to section [6.3.2](#) for instructions on how to identify the package front):
 - Preferred placement: On the lower right quadrant of the back, near the edge, respecting the proper Quiet Zone areas around the barcode.
 - Alternative placement: On the lower right quadrant of the front, near the edge, respecting the proper Quiet Zone areas around the barcode.
 - Edge rule: See section [6.3.3.3](#).

Figure 6.4.6-1. Barcode placement on carded items

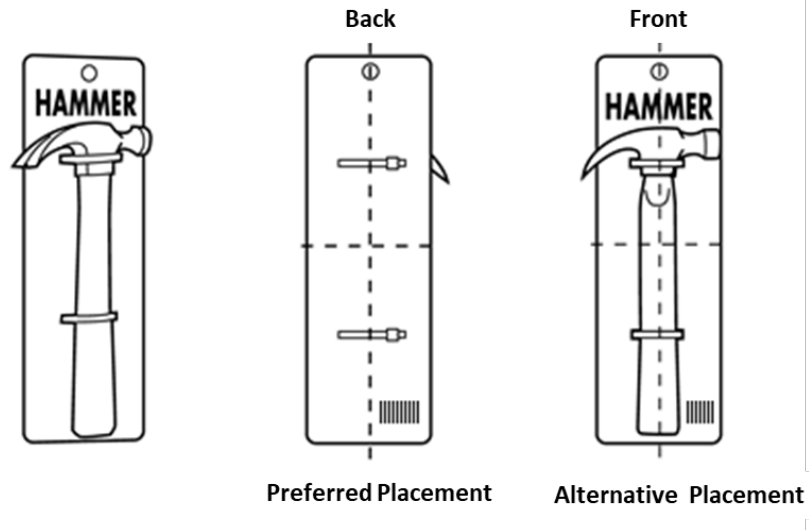

6.4.7 Egg cartons

Moulded pulp, foam, or plastic egg cartons come in sizes according to the number of eggs contained.

- Package characteristics: Irregular shaped hexahedrons of plastic or moulded pulp with a hinged lid.
- Unique considerations: The recommended barcode placement is on the side of the lid portion of the egg carton that opens and closes to cover the eggs. The uneven surface of the moulded bottom of an egg carton prevents barcode placement in this area.
- Barcode placement: To determine barcode placement on an egg carton, first identify the top of the carton by locating the primary trading/advertising area, which is marked with the product name and the company’s logo. The bottom of the egg carton is the moulded area directly opposite the top in which the eggs sit. The sides are divided horizontally by a hinged lid. The front of the carton is the long side containing the opening/closing mechanism. The back of the carton is directly opposite the front, on the long side with the hinge:
 - Preferred placement: Near the edge, on the right half of the back, above the hinge on the lid, respecting the proper Quiet Zone areas around the barcode.
 - Alternative placement: On the lower right quadrant of the top, on the lid adjacent to the opening/closing mechanism, near the edge, respecting the proper Quiet Zone areas around the barcode.
 - Edge rule: See section [6.3.3.3](#).

Figure 6.4.7-1. Barcode placement on egg cartons

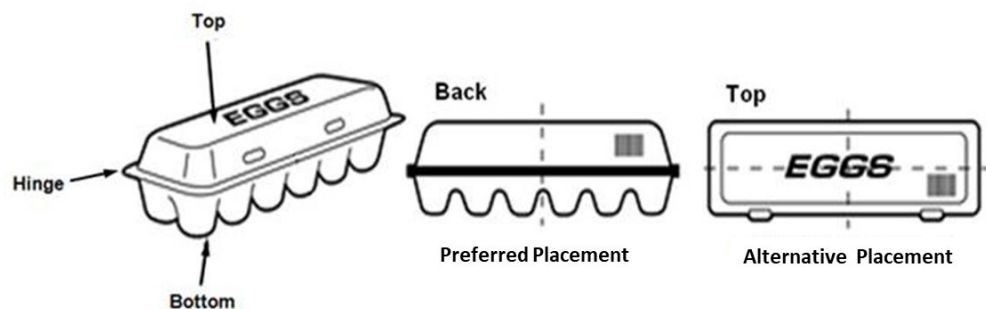

6.4.8 Jugs

Jugs are glass or plastic containers with a built-in handle(s) that aids in pouring of contents. Jugs normally carry spot labels applied to defined areas of the package, not covering the entire surface of the trade item or wrapping around the entire perimeter of the item.

- Package characteristics: Glass or plastic vessels with built-in handles and removable lids.
- Unique considerations: Application of the barcode to the neck of the jug is not allowed. Placement of the barcode on the neck of the jug necessitates additional handling at the POS and space limitations on the neck usually result in barcode truncation.

When a barcode is printed onto a curved surface it is sometimes possible for the extremes of the barcode to disappear around the curve. See section [6.2.3.2](#) for the rules on the relationship between the diameter of the item and the X-dimension.

- Barcode placement: Identify the front of the package/container. (Refer to section [6.3.2](#) for instructions on how to identify the package front):
 - Preferred placement: On the lower right quadrant of the back, near the edge, respecting the proper Quiet Zone areas around the barcode.
 - Alternative placement: On the lower right quadrant of the front, near the edge, respecting the proper Quiet Zone areas around the barcode.
 - Edge rule: See section [6.3.3.3](#).

Figure 6.4.8-1. Barcode placement on jugs

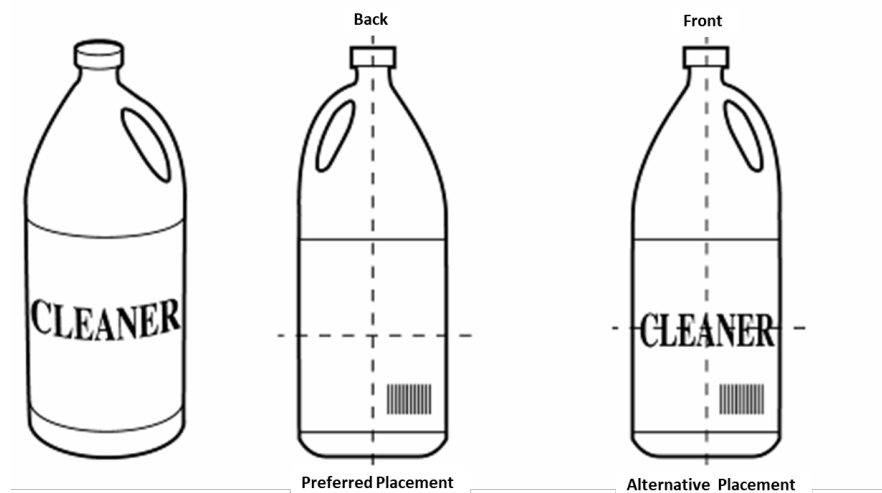

6.4.9 Large, heavy, or bulky items

- Package characteristics: Items considered large, heavy, or bulky have a physical dimension of 450 millimetres (18 inches) or more in any two dimensions (width/height, width/depth or height/depth) and/or weigh in excess of 13 kilograms (28 pounds).
- When a linear barcode and a 2D barcode are both being used for retail POS applications, the entire 2D barcode including Quiet Zones SHOULD be placed within a 50 millimetre (2 inches) radius from the centre of the linear barcode.
- Unique considerations:
 - Number of barcodes: Large, heavy, or bulky items SHOULD have barcodes placed on top and on the bottom of the opposite faces of the trade item.

- Special labels: A special double label with a tear-out barcode may be applied to large, heavy, or bulky items that are too heavy or awkward to pick up and pass over a fixed scanner. This label has one section that is permanently adhered to the item's box (or to a hang-tag or card if the item is not boxed). This section has a non-HRI text (number and item description) printed above a full-size barcode. Beneath a perforation, a second section contains exactly the same non-HRI text and an identical full-size barcode. The two sections are virtually identical except that the section below the perforation has no adhesive on its back.

Figure 6.4.9-1.

SAMPLE ILLUSTRATION OF THE DOUBLE LABEL WITH TEAR-OUT UPC

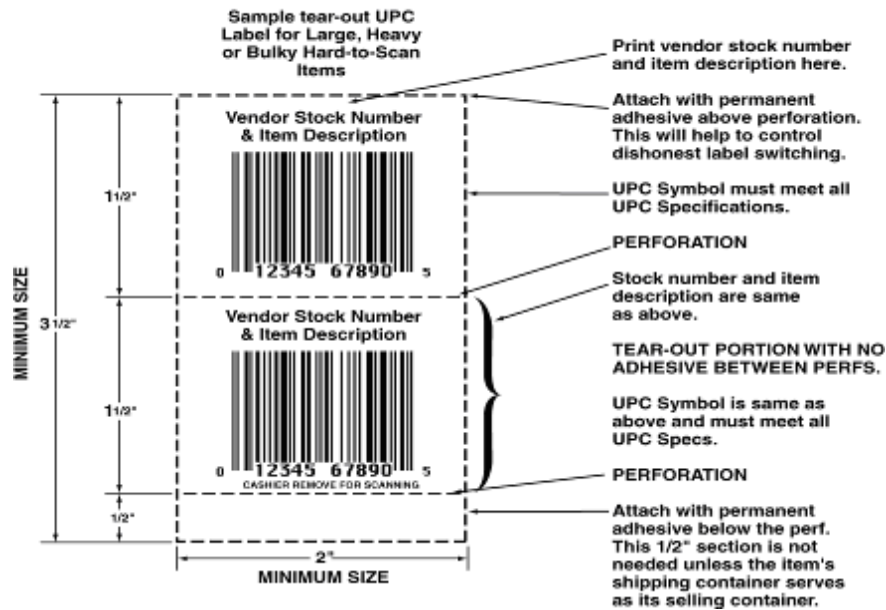

- When the item is brought to the POS, the lower half of the label below the perforation is removed. The cashier then either scans the label or, if the barcode cannot be scanned, the cashier key-enters the human readable interpretation beneath the barcode. The top label remains attached to the item or its box.

In instances where the large, heavy, or bulky item is displayed and sold in its shipping container, a third section of label is recommended. Beneath the tear-out label, a second perforation and a 12 millimetres (0.50 inch) section with permanent adhesive SHALL be added. This provides a more secure vehicle for the tear-out section and makes it less likely to tear off in transit.

- Human readable interpretation: Human readable interpretation on large, heavy, or bulky items SHOULD be a minimum of 16 millimetres (5/8 inch) high. This facilitates easier capture of the number by the cashier without having to pick up the product and move it across the scanner.
- Barcode placement: Identify the front of the trade item (See section [6.3.2](#), for instructions on how to identify the package front).
- Preferred placement:
 - Bags: Barcode(s) SHOULD be placed on the front of the bag, at the top of the upper right quadrant, near the edge and the other(s) on the back of the bag, centred in the lower right quadrant, near the edge (to accommodate settling of contents).

Figure 6.4.9-2. Barcode placement on large, heavy, or bulky bags

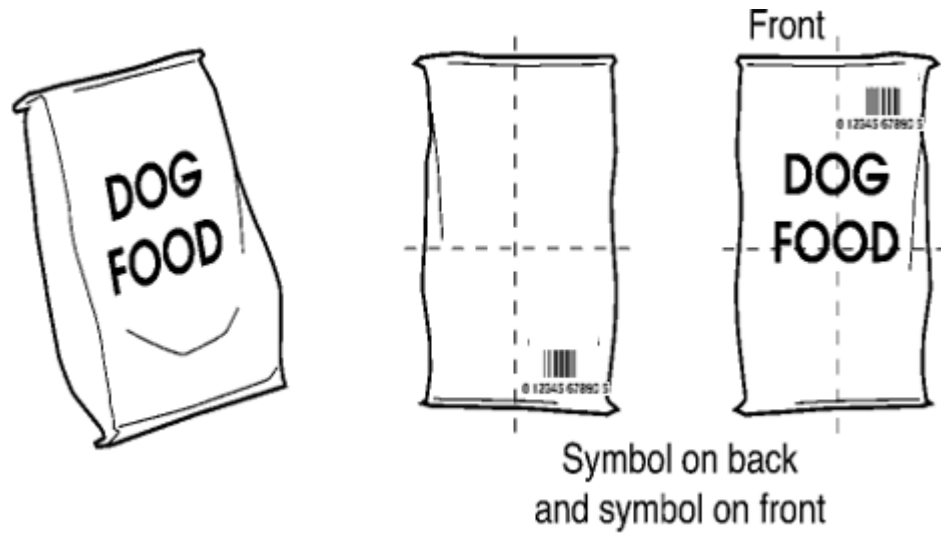
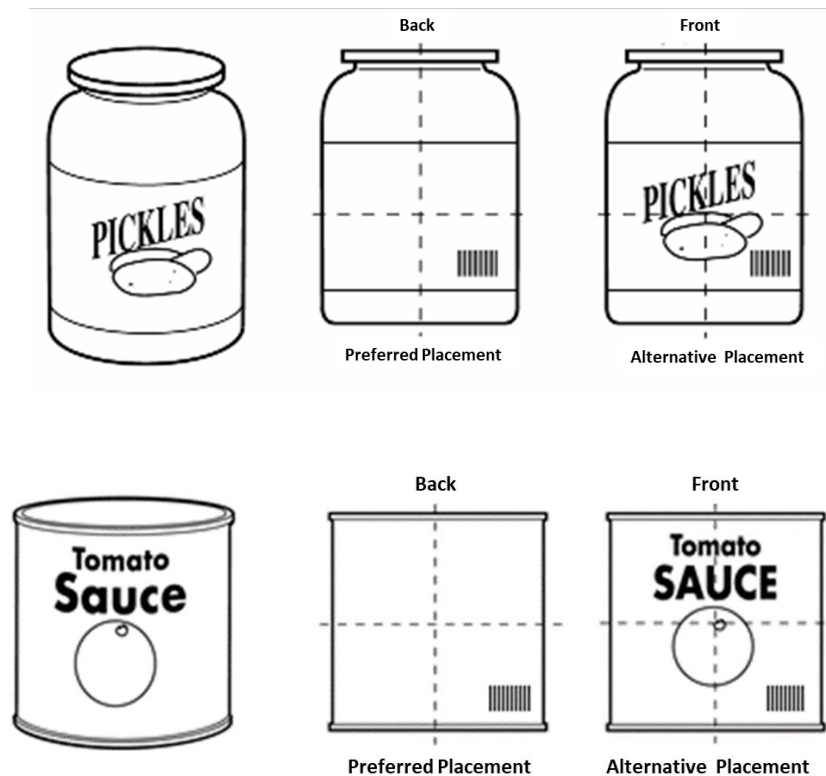

Figure 6.4.9-3. Barcode placement on large, heavy, or bulky jars, cans, jugs, or tubs



- Alternative placement: On the lower right quadrant of the front, near the edge, respecting the proper Quiet Zone areas around the barcode.
- Edge rule: See section [6.3.3.3](#).

6.4.10 Multipacks

Multipacks are single items that are packaged together as one unit or trade item. Multipacks provide convenience to the consumer and/or may represent a price reduction compared to purchasing items individually. Typical multipacks contain bottles, cans, jars and tubs.

- Package characteristics: multiple single items bound together to create one package.

- Unique considerations: as a general rule, a barcode MUST be placed on every consumer package traded through the supply chain. Consequently, items sold in multipacks as well as those sold individually must carry a unique barcode for each consumer package variation or aggregation. To avoid confusion at the POS, the multipack barcode SHALL be the only visible barcode when both the multipack and individual items are barcode-marked. The binder of the multipack acts as a screen to obscure the barcodes on the individual items.
 - Special note for can multipacks: Avoid placing the barcode on the top or bottom of the container, since cans have a tendency to cause impressions in the corrugated cardboard and distort the barcode. These can impressions in the barcode may reduce scannability.
- Barcode placement: identify the front of the package/container. (Refer to section [6.3.2](#) for instructions on how to identify the package front):
 - Preferred placement: on the lower right quadrant of the back, near the edge, respecting the proper Quiet Zone areas around the barcode.
 - Alternative placement: on the lower right quadrant of another surface, near the edge, respecting the proper Quiet Zone areas around the barcode.
 - Edge rule: See section [6.3.3.3](#).

Figure 6.4.10-1. Barcode placement on multipacks

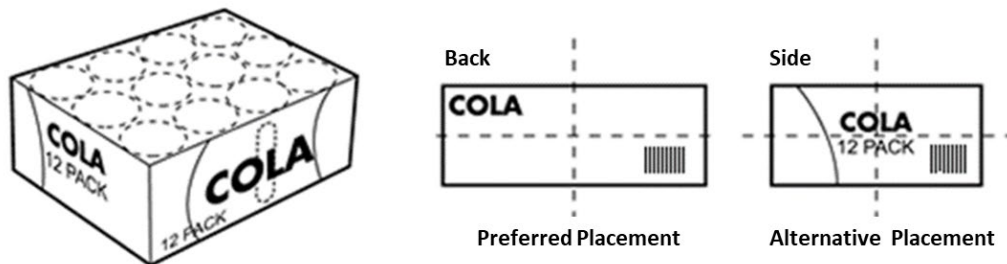

6.4.11 Publishing items

Publishing items represent printed materials sold individually for consumer use including books, magazines, newspapers and tabloids. Barcode placement on published items varies depending on type. In addition, the main barcode on books and paperbacks must appear on the outside cover of the book (to facilitate payment).

- Package characteristics: printed paper media that is bound, stapled, or folded.
- Unique considerations: in addition to the regular barcode, some publishing items have add-on symbols that carry supplementary information such as an Issue Code. Barcode placement on published items varies depending on the media type. If an add-on symbol is used, it must be located to the right of the regular barcode and parallel to it.
- Barcode placement: identify the front of the package/container. (Refer to section [6.3.2](#) for instructions on how to identify the package front):
 - Preferred placement:
 - Books: on the lower right quadrant of the back, near the spine, respecting the proper Quiet Zone areas around the barcode.

Figure 6.4.11-1. Barcode placement on books

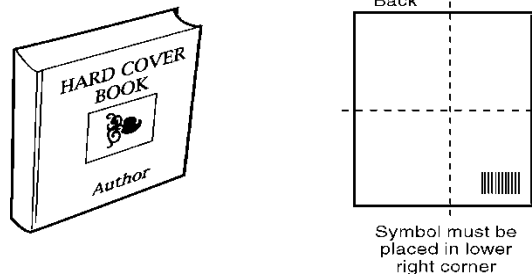

- Magazines: On the lower left quadrant of the front, near the edge, respecting the proper Quiet Zone areas around the barcode.

Figure 6.4.11-2. Barcode placement on magazines

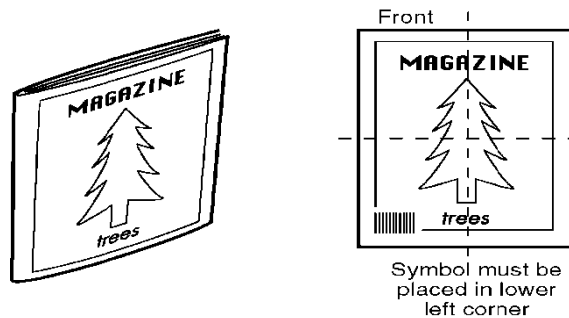

- Newspapers: when displayed for sale as shown on the left in figure [6.4.11-3](#), place the barcode on the lower left quadrant of the front, near the edge, respecting the proper Quiet Zone areas around the barcode. If an add-on symbol is used, it must be located to the right of the regular barcode and parallel to it.

Figure 6.4.11-3. Barcode placement on newspapers

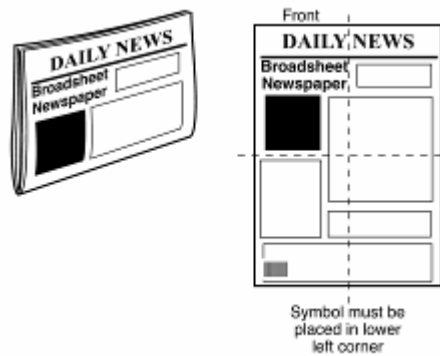

When displayed for sale as shown in figure [6.4.11-4](#), place the barcode on the lower right quadrant of the back, near the edge, respecting the proper Quiet Zone areas around the barcode. If an add-on symbol is used, it must be located to the right of the regular barcode and parallel to it.

Figure 6.4.11-4. Barcode placement on newspapers

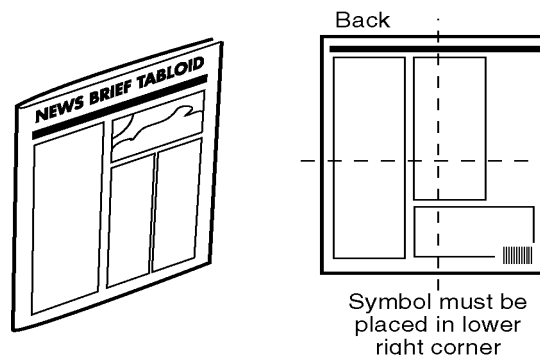

- Alternative placement: The alternative placement is not feasible for this package type.
- Edge rule: See section [6.3.3.3](#).

6.4.12 Thin items or containers

This package type is so named because items and containers in this category have one physical dimension less than 25 millimetres (1 inch). Items such as these, particularly those without a significant bottom surface, **SHOULD** be marked on the lower right quadrant of the back side. Boxes of pizza, compact disk boxes, packages of powdered drink mix and writing pads are examples.

- Package characteristics: items or containers with one dimension less than 25 millimetres (1 inch).
- Unique considerations: there are no unique considerations that apply to this package type.
- Barcode placement: identify the front of the package/container. (Refer to section [6.3.2](#) for instructions on how to identify the package front):
 - Preferred placement: on the lower right quadrant of the back, near the edge, respecting the proper Quiet Zone areas around the barcode.
 - Alternative placement: on the lower right quadrant of the front, near the edge, respecting the proper Quiet Zone areas around the barcode.
 - Edge rule: See section [6.3.3.3](#).

Figure 6.4.12-1. Barcode placement on thin items or containers

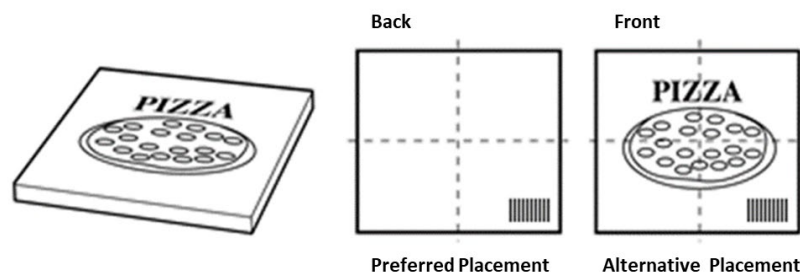
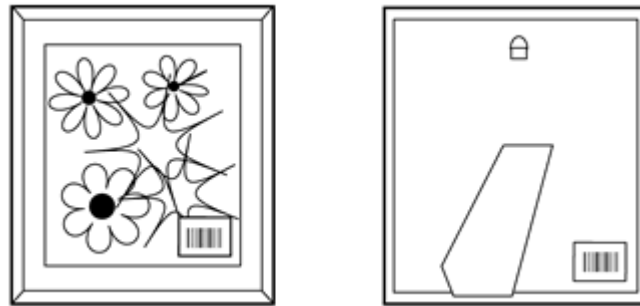

Figure 6.4.12-2. Unpackaged item without room for bottom marking



6.4.13 Trays

This package type includes thin square, rectangular, or circular trays holding items that are covered with over-wrap of clear shrink-film or that are vacuum-sealed. Examples include meats, pastries, snacks and pies or piecrusts.

- Package characteristics: Flat, formed receptacles holding product covered with over-wrap.
- Unique considerations: When placing barcodes on trays, it is important to ensure that the barcode is placed on a flat surface. In addition, do not place the barcode over any perforations or other obstructions on the package.
- Barcode placement: Identify the front of the package/container. (Refer to section [6.3.2](#) for instructions on how to identify the package front):
 - Preferred placement: On the lower right corner of the top, near the edge, respecting the proper Quiet Zone areas around the barcode.
 - Edge rule: See section [6.3.3.3](#).

Figure 6.4.13-1. Barcode placement on trays

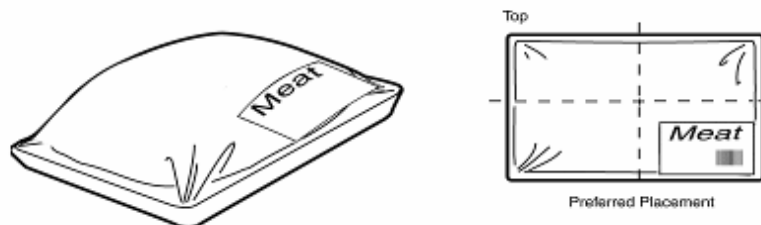

6.4.14 Tubes

Tubes are cylindrical shaped items or containers that are either sealed at both ends, such as sausage or refrigerated dough, or that are sealed at one end and have a cap or valve on the other end, such as toothpaste or caulk.

- Package characteristics: Firmly packed cylinders sealed at both ends, or sealed at one end with a cap or valve on the other end.
- Unique considerations: When a barcode is printed onto a curved surface it is sometimes possible for the extremes of the barcode to disappear around the curve. See section [6.2.3.2](#) for the rules on the relationship between the diameter of the item and the X-dimension.
- Barcode placement: Identify the front of the package/container. (Refer to section [6.3.2](#) for instructions on how to identify the package front):
 - Preferred placement: On the lower right quadrant of the back, near the edge, respecting the proper Quiet Zone areas around the barcode.

- Alternative placement: On the lower right quadrant of the front, near the edge, respecting the proper Quiet Zone areas around the barcode.
- Edge rule: See section [6.3.3.3](#).

Figure 6.4.14-1. Barcode placement on tubes

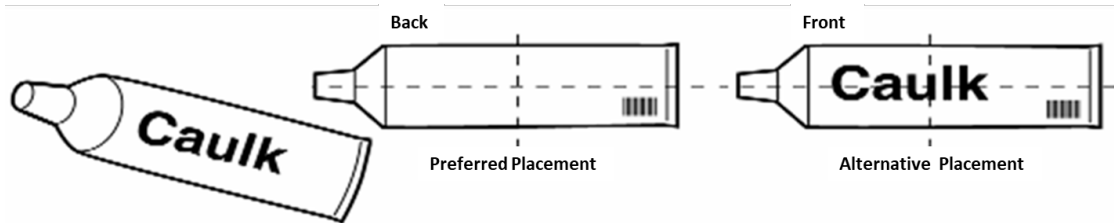

6.4.15 Tubs

Tubs are circular containers (usually made of paper, plastic, or metal) that have removable lids. In most cases, they have spot labels that do not cover the entire surface of the container. Examples include margarine, butter, ice cream and whipped topping.

- Package characteristics: Deep vessels with removable lids.
- Unique considerations: When a barcode is printed onto a curved surface it is sometimes possible for the extremes of the barcode to disappear around the curve. See section [6.2.3.2](#) for the rules on the relationship between the diameter of the item and the X-dimension.
- Barcode placement: Identify the front of the package/container. (See section [6.3.2](#) for instructions on how to identify the package front):
 - Preferred placement: On the lower right quadrant of the back, near the edge, respecting the proper Quiet Zone areas around the barcode.
 - alternative placement: On the lower right quadrant of the front, near the edge, respecting the proper Quiet Zone areas around the barcode.
 - Edge rule: See section [6.3.3.3](#).

Figure 6.4.15-1. Barcode placement on tubs

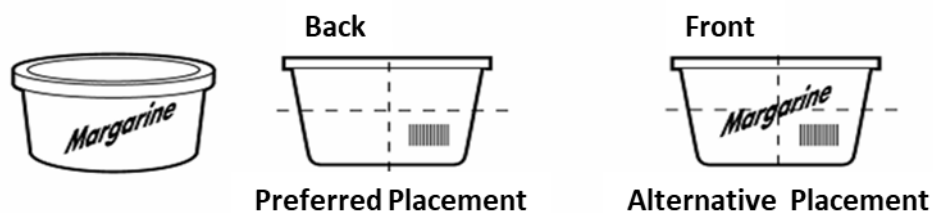

6.4.16 Unpackaged items

These are square, rectangular, circular, concave, or convex shaped items, including bowls, pots, pans, skillets, cups, vases and other products (with or without contents), that lack an upright surface suitable for barcode placement.

- Package characteristics: These are items that are unpackaged and sold with spot labels, hangtags or carded sleeves.
- Unique considerations: When selecting barcode placement, consider the product's concave shape on the inside or irregular curvature on the outside while respecting the scanning distances defined in the edge rule below.

- The general marking guideline for table and giftware items is to use a hangtag. This avoids any damage to the item that could be caused by the spot label adhesive. If this is not practical, the spot label SHALL be applied to the bottom of the item and below the backstamp (where present).
- Barcode placement: Barcode placement on unpackaged items depends on the shape and type of the item. The following examples illustrate barcode placements appropriate to specific item types.
 - Preferred placement: The figures that follow indicate acceptable placement locations for other shaped items.
 - Alternative placement: The undesirable alternative is not applicable.
 - Edge rule: See section [6.3.3.3](#).

Figure 6.4.16-1. Example barcode location on unpackaged item

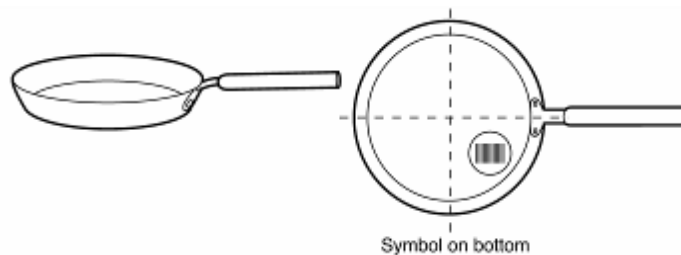

Figure 6.4.16-2. Example barcode location on unpackaged item

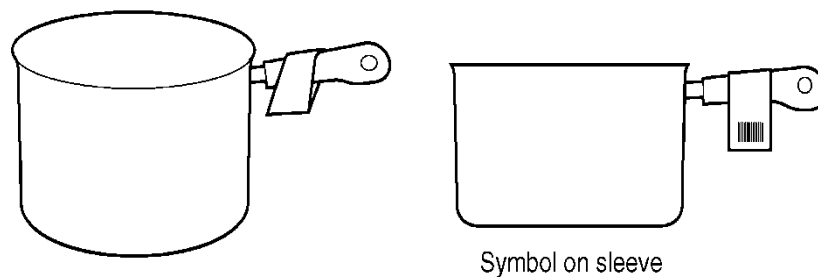

Figure 6.4.16-3. Example barcode location on unpackaged item

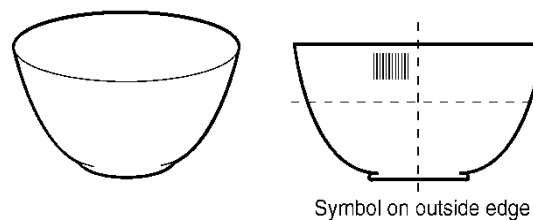

Figure 6.4.16-4. Example barcode location on unpackaged item

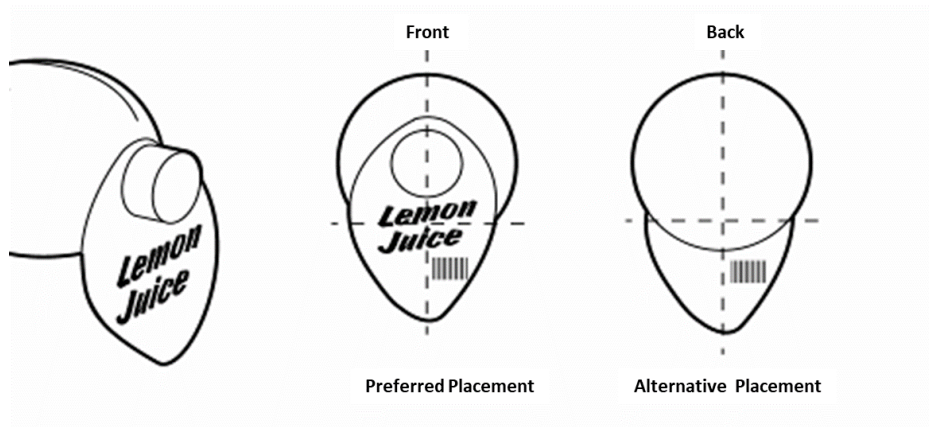
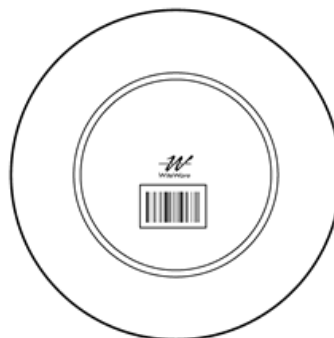

Figure 6.4.16-5. Giftware using hangtag



Figure 6.4.16-6. Tableware using spot label below backstamp



6.4.17 Sets (grouping of individually barcoded items)

For barcoding purposes, sets are defined as two or more items that are packaged and sold together as one unit, regardless of whether those items can be sold separately as well. If the items are packaged together for shipping purposes but are not intended to be sold as a single unit, they do not qualify as a set. Examples of sets include a pair of candlesticks, a set of four soup bowls and a five-piece dinner place setting.

If a set is not intended to be sold as individual components, only the package for the set needs to include a barcode.

Figure 6.4.17-1. Example of a set where individual components are not sold separately

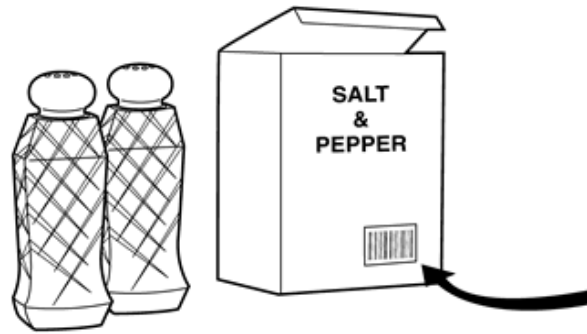

If the set is made up of components that can be ordered as separate trade items, then the components of the set must be marked. If the set can be sold as individual components or as the set, then both the package and the components need to be marked with unique barcodes. The barcodes on the inner products must be totally obscured so that they cannot be read by the POS system when sold as a set. (See section [6.3.3.7](#) for over-wrap special considerations.)

Figure 6.4.17-2. Example of a multi-piece set sold as a set or as individual components

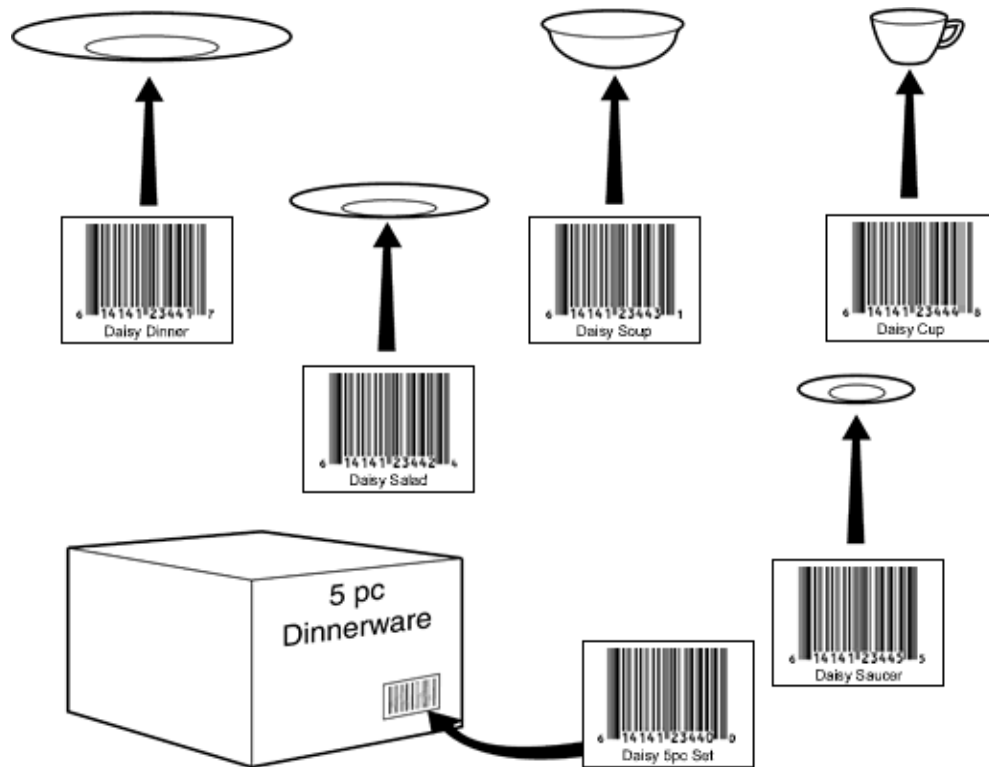

If an item is made up of multiple components that cannot be sold separately, such as a teapot with lid, the main piece only SHALL be marked with one barcode. Such items are not considered sets.

Figure 6.4.17-3. Items with multiple pieces that are not sold separately (these are not considered sets)

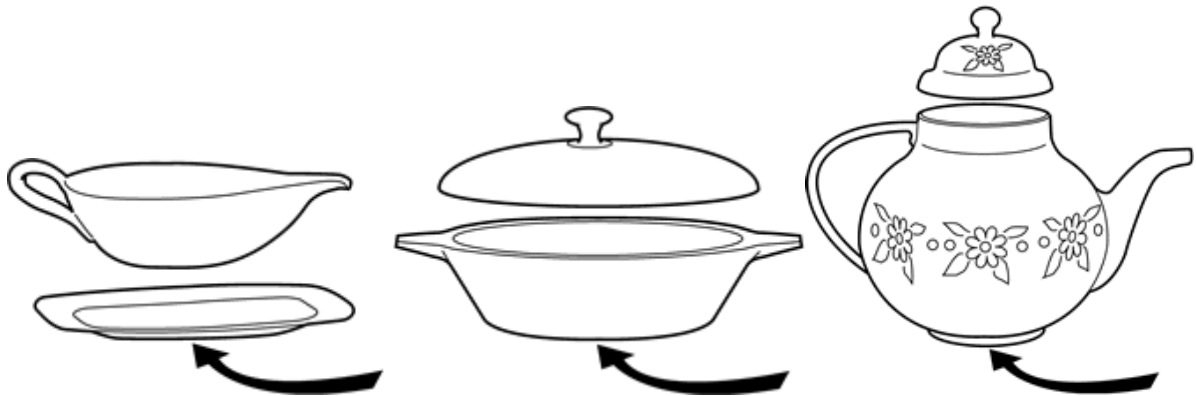

6.4.18 Sporting goods

Sporting goods is a category composed of many irregular sized and shaped goods. An understanding of each product type, the logistics involved in the supply chain and the sales floor presentation are key to improving the overall POS efficiency. Of particular importance is consistent barcode placement for sporting goods as presented at the retail POS. This enables the POS operator to accurately predict the barcode location and thereby improve efficiency. The following examples, while not exhaustive, provide the general principles that are applied to similar product types.

6.4.18.1 Archery bows, arrows

- Preferred placement:
 - If packaged in boxes, see section [6.4.4](#).
 - If packaged using a hangtag, see section [6.5.2](#).
- Edge rule: See section [6.3.3.3](#).

Figure 6.4.18.1-1. Example barcode location on a crossbow

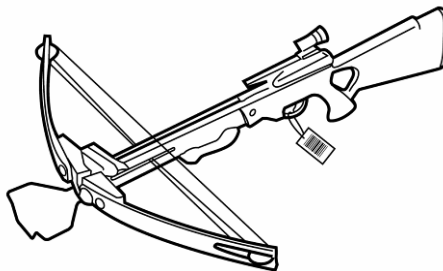

6.4.18.2 Balls, team sports

- Preferred placement:
 - If packaged individually, placement on the shrink wrap.
 - If packaged in boxes or boxed sets, see section [6.4.4](#) and section [6.4.17](#). If a master SKU is not utilised for a boxed set of balls or a pack set of ball and pump, each product type within the pack set SHALL have a screened barcode.
 - If not packaged, screen the barcode on the opposite side of the logo on the ball.
- Edge rule: See section [6.3.3.3](#)

Figure 6.4.18.2-1. Example barcode locations on a box of balls & separate balls

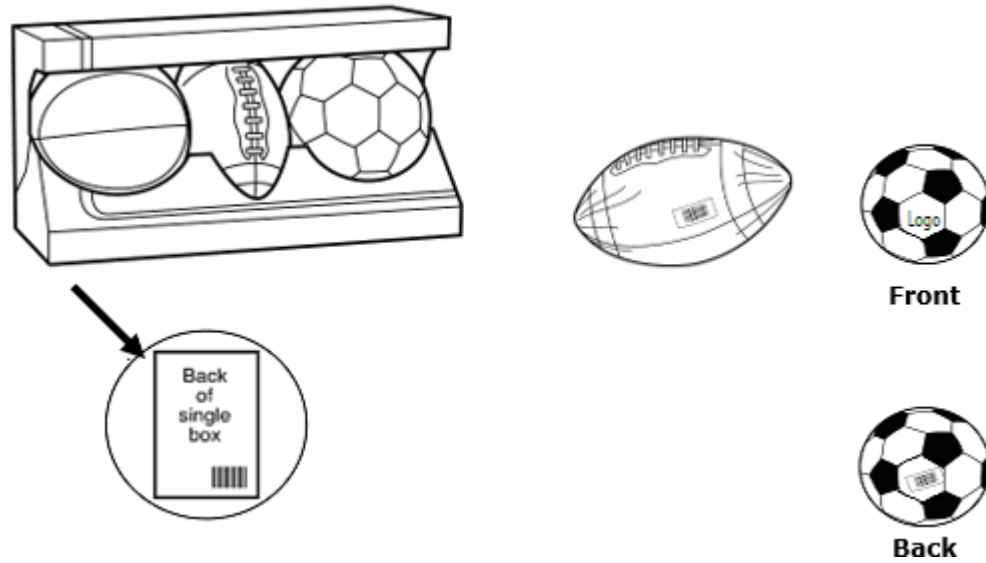

6.4.18.3 Bats, team sports

- Preferred placement: On the barrel handle of the bat, respecting the proper Quiet Zone areas around the barcode.
- Edge rule: See section [6.3.3.3](#)

Figure 6.4.18.3-1. Example barcode location on a baseball bat

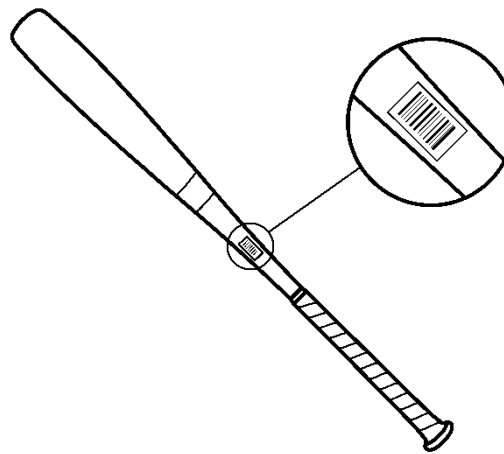

6.4.18.4 Bicycles

- Preferred placement: On the right hand fork of the bike, respecting the proper Quiet Zone areas around the barcode.
- Alternative placement: On a hangtag around the right hand brake cable, respecting the proper Quiet Zone areas around the barcode.
- Edge rule: See section [6.3.3.3](#)

Figure 6.4.18.4-1. Example barcode location on a bicycle

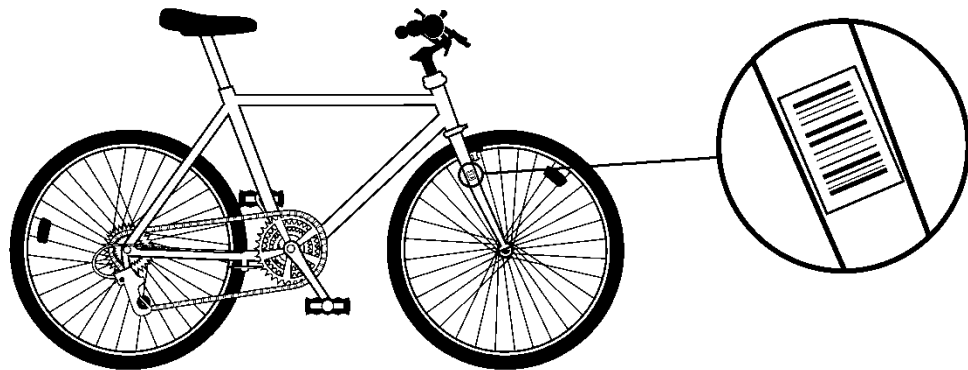

6.4.18.5 Climbing gear

- Preferred placement:
 - If packaged in boxes, see section [6.4.4](#)
 - If packaged using a hangtag, see section [6.5.2](#)
 - If packaged as carded items, see section [6.4.6](#)
- Edge rule: See section [6.3.3.3](#)

Figure 6.4.18.5-1. Example barcode locations on climbing gear

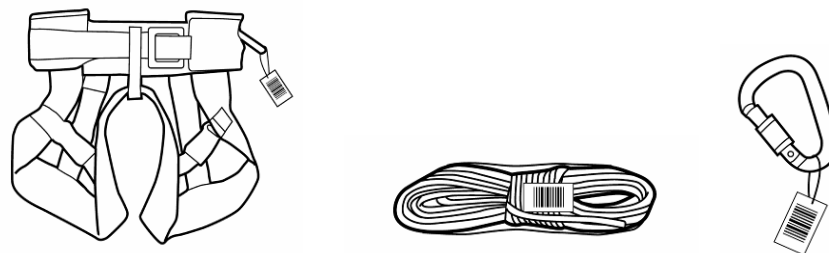

6.4.18.6 Fishing rods

- Preferred placement: On the grip of the fishing rod near the sealed end, respecting the proper Quiet Zone areas around the barcode. When a barcode is printed onto a curved surface, it is sometimes possible for the extremes of the barcode to disappear around the curve. See section [6.2.3.2](#) for the rules on the relationship between the diameter of the item and the X-dimension.
- Alternative placement: On a cardboard wrap or a hangtag on the shaft of the fishing rod, respecting the proper Quiet Zone areas around the barcode.
- Edge rule: See section [6.3.3.3](#)

Figure 6.4.18.6-1. Barcode location on a fishing rod

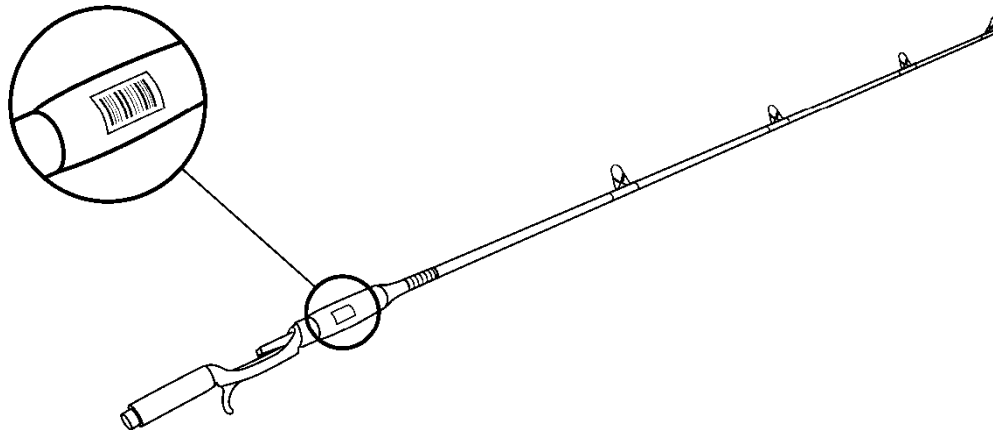

6.4.18.7 Fitness accessories

- Preferred placement:
 - If packaged in boxes, see section [6.4.4](#)
 - If packaged using a hangtag, see section [6.5.2](#)
 - If packaged as carded items, see section [6.4.6](#)
- Edge rule: See section [6.3.3.3](#)

Figure 6.4.18.7-1. Example barcode location on a box of fitness accessories

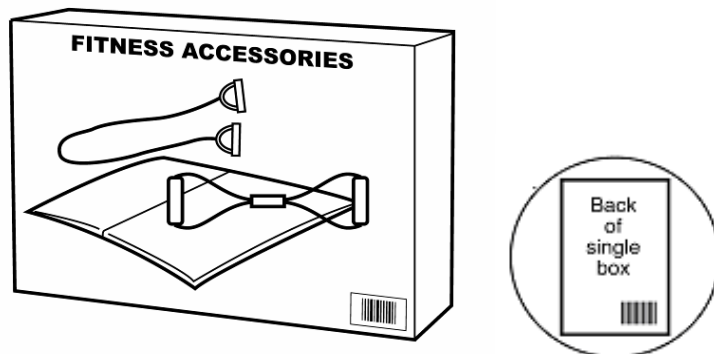

6.4.18.8 Gloves, mitts (sports)

- Preferred placement:
 - If packaged in boxes, see section [6.4.4](#)
 - If packaged using a hangtag, see section [6.5.2](#)
 - If packaged in bags, see section [6.4.1](#)
 - If not packaged, see section [6.4.9](#)
- Edge rule: See section [6.3.3.3](#)

Figure 6.4.18.8-1. Example barcode locations on gloves

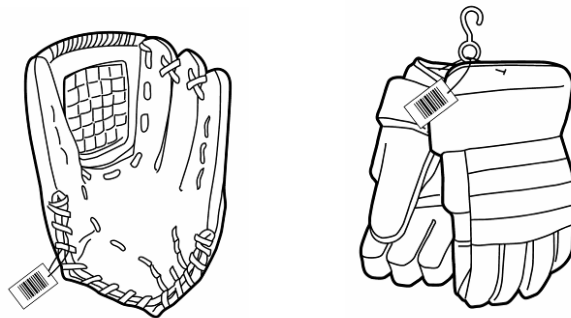

6.4.18.9 Golf club

- Preferred placement: On the shaft of the club located near the club head, respecting the proper Quiet Zone areas around the barcode. When a barcode is printed onto a curved surface, it is sometimes possible for the extremes of the barcode to disappear around the curve. See section [6.2.3.2](#) for the rules on the relationship between the diameter of the item and the X-dimension. Barcodes SHALL NOT be located on the head of the golf club as barcodes located on this flat area (normally preferable to locating barcodes on a curved surface) are easily damaged due to customer trials.
- Alternative placement: On the grip of the club near the sealed end, respecting the proper Quiet Zone areas around the barcode.
- Edge rule: See section [6.3.3.3](#)

Figure 6.4.18.9-1. Example barcode location on a golf club

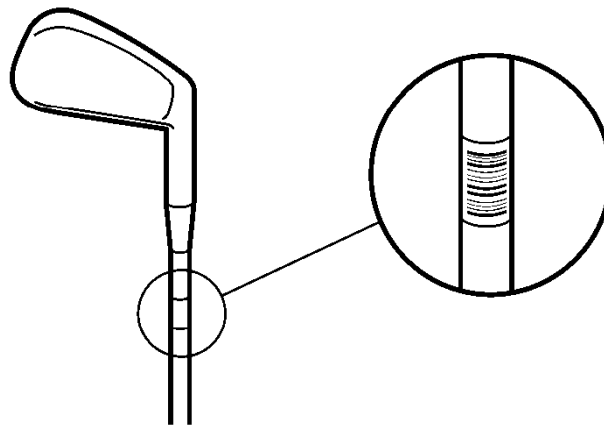

6.4.18.10 Guns

- Preferred placement:
 - If packaged using a hangtag, see section [6.5.2](#)
 - If packaged as a blister pack, see section [6.4.2](#)
 - If not packaged, placement near serial number
- Edge rule: See section [6.3.3.3](#)

Figure 6.4.18.10-1. Example barcode locations on a shotgun and paint ball gun

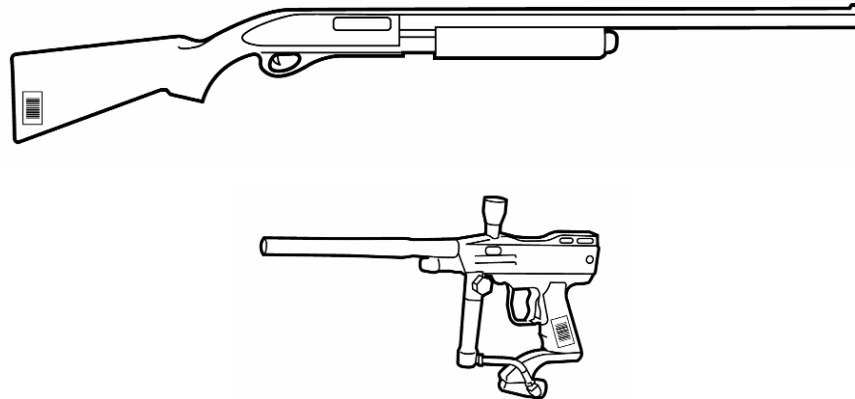

6.4.18.11 Helmets, masks (sports)

- Preferred placement:
 - If packaged in boxes, see section [6.4.4](#)
 - If packaged using a hangtag, see section [6.5.2](#)
 - If not packaged, see section [6.4.9](#)
- Edge rule: See section [6.3.3.3](#)

Figure 6.4.18.11-1. Example barcode location on a helmet

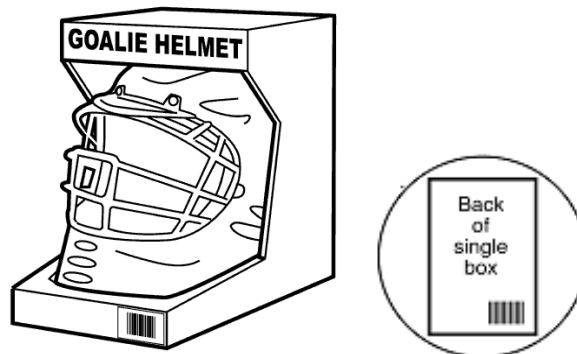

6.4.18.12 Ice-hockey and field hockey

- Preferred placement: On the flat blade of the stick, respecting the proper Quiet Zone areas around the barcode.
- Alternative placement: At the very top of the shaft of the stick, respecting the proper Quiet Zone areas around the barcode. When a barcode is printed onto a curved surface, it is sometimes possible for the extremes of the barcode to disappear around the curve. See section [6.2.3.2](#) for the rules on the relationship between the diameter of the item and the X-dimension.
- Edge rule: See section [6.3.3.3](#)

Figure 6.4.18.12-1. Example barcode location on an ice-hockey stick

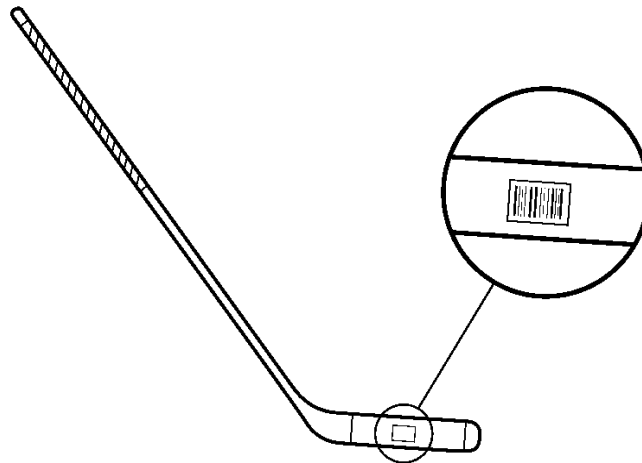

6.4.18.13 Multi-sports-product pack sets

- Preferred placement:
 - For placement on bags, see section [6.4.1](#)
 - For placement on hangtags, see section [6.5.2](#)
- Edge rule: See section [6.3.3.3](#)

Figure 6.4.18.13-1. Example barcode location on a product pack

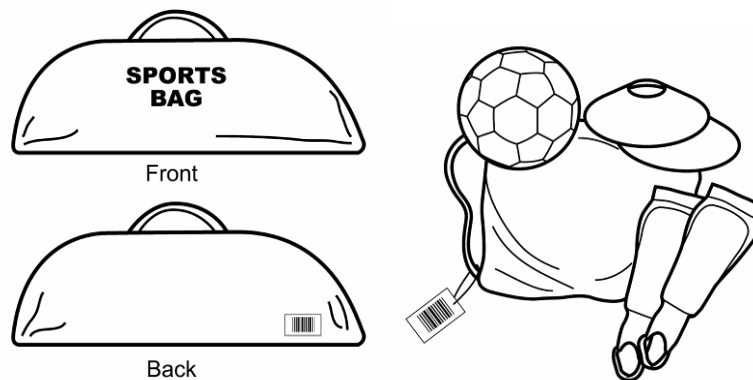

6.4.18.14 Pressure gauges and sports pumps

- Preferred placement:
 - If packaged as carded items, see section [6.4.6](#)
 - If packaged in bags, see section [6.4.1](#)
 - If not packaged, placement on the wrap band securing the tip/needles, etc.
- Edge rule: See section [6.3.3.3](#)

Figure 6.4.18.14-1. Example barcode location on a carded item

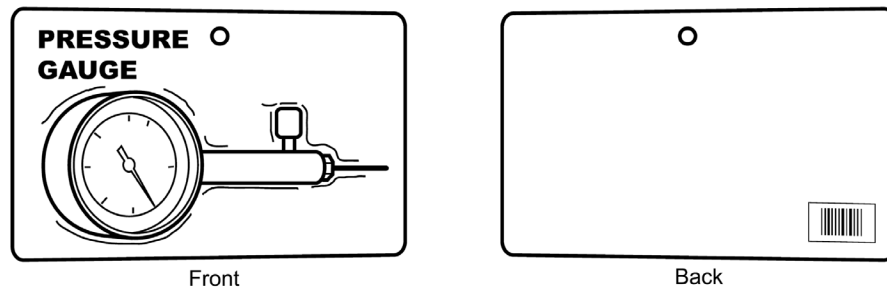

6.4.18.15 Protective gear, guards, vests

- Preferred placement:
 - If packaged as a carded item, see section [6.4.6](#)
 - If not packaged, see section [6.4.9](#)
- Edge rule: See section [6.3.3.3](#)

Figure 6.4.18.15-1. Example barcode location on guards

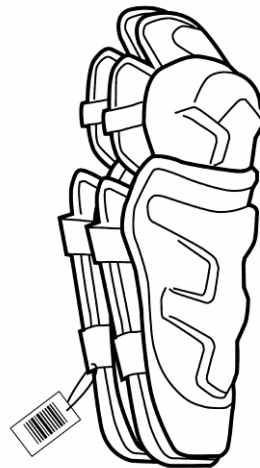

6.4.18.16 Racquets

- Preferred placement: On the grip of the racquet near the sealed end, respecting the proper Quiet Zone areas around the barcode. When a barcode is printed onto a curved surface it is sometimes possible for the extremes of the barcode to disappear around the curve. See section [6.2.3.2](#) for the rules on the relationship between the diameter of the item and the X-dimension.
- Alternative placement: On the cardboard wrap placed over the head of the racquet near the edge of the racquet head, respecting the proper Quiet Zone areas around the barcode.
- Edge rule: See section [6.3.3.3](#)

Figure 6.4.18.16-1. Example barcode location on a racquet

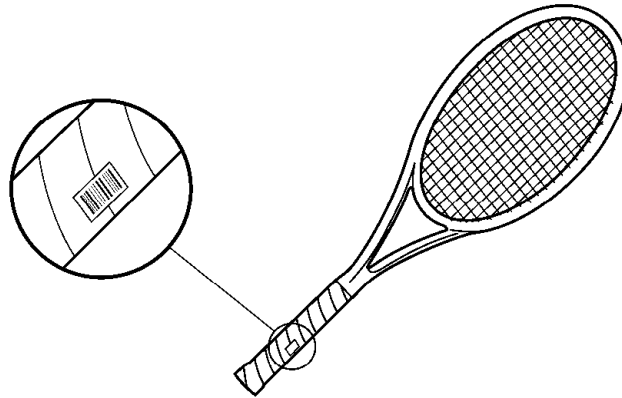

6.4.18.17 Skateboards

Skateboards are often displayed in their packages. See section [6.2.3](#), Orientation, to determine the back of the package. For unpackaged items:

- Preferred placement: On the bottom side of the skateboard on the top above the wheels, respecting the proper Quiet Zone areas around the barcode.
- Edge rule: See section [6.3.3.3](#)

Figure 6.4.18.17-1. Example barcode location on a skateboard

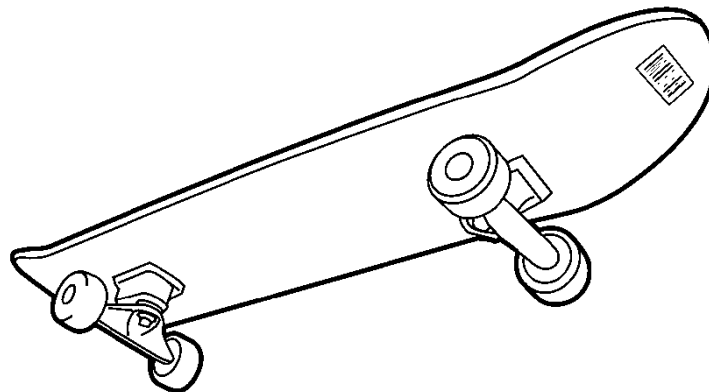

6.4.18.18 Skates

- Preferred placement:
 - If packaged in boxes, see section [6.4.4](#)
 - If packaged using hangtags, see section [6.5.2](#).
- Edge rule: See section [6.3.3.3](#)

Figure 6.4.18.18-1. Example barcode location on a box of skates

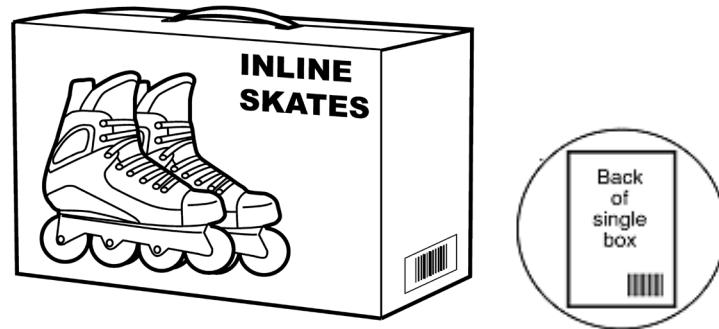

6.4.18.19 Skis

Skis are displayed without their packaging. The front of the ski is the side where the ski boots are placed and the back of the ski is the opposite side.

- Preferred placement: One barcode is placed on the back of the ski near the top of the ski, respecting the proper Quiet Zone areas around the barcode. Only one barcode is required per pair.
- Edge rule: See section [6.3.3.3](#)

Figure 6.4.18.19-1. Example barcode location on a ski

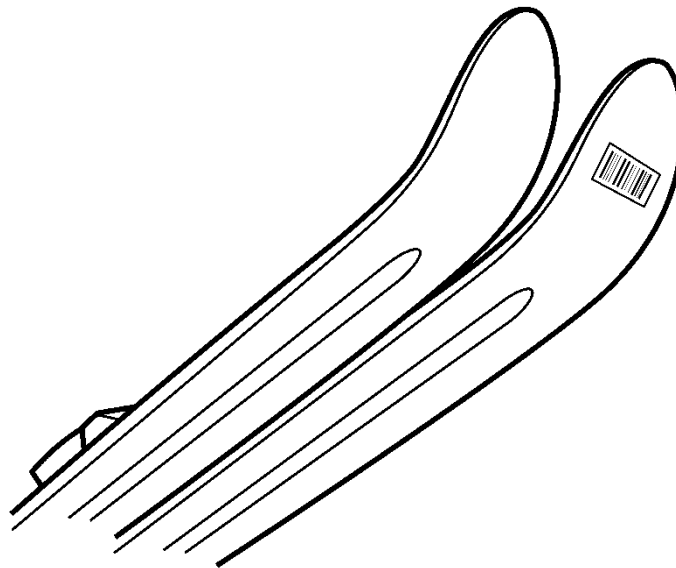

6.4.18.20 Water bottles (sports)

- Preferred placement:
 - If packaged in boxes, see section [6.4.4](#)
 - If packaged using hangtags, see section [6.5.2](#)
 - If not packaged, placement on the side of the bottle.
- Edge rule: See section [6.3.3.3](#)

Figure 6.4.18.20-1. Example barcode location on a water bottle

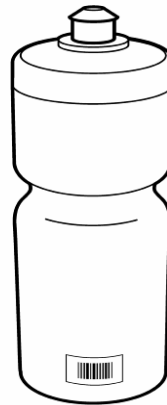

6.4.18.21 Water sports crafts

- Preferred placement:
 - If packaged in boxes, see section [6.4.4](#)
 - If packaged using hangtags, see section [6.5.2](#)
 - If not packaged, see section [6.4.9](#), Large, heavy, or bulky items
- Edge rule: See section [6.3.3.3](#)

Figure 6.4.18.21-1. Example barcode location on a canoe

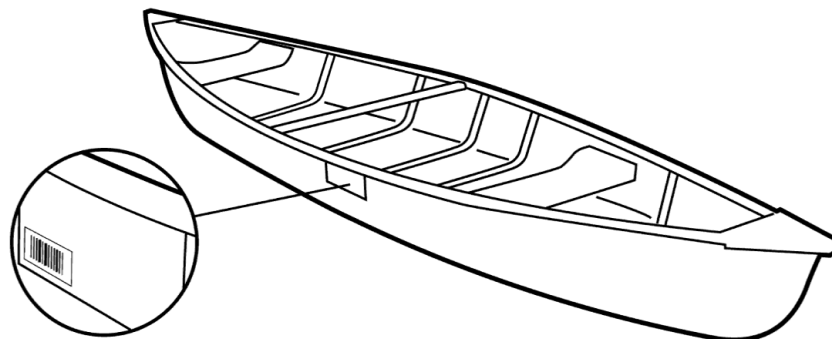

6.4.19 Textured surfaces

Some merchandise may not allow for application of barcode labels due to rough or textured surfaces. These surfaces can distort the label and thus the barcode. Alternative labelling options such as hang tags or loop tags may be necessary.

6.5 Barcode placement for clothing and fashion accessories

Clothing is displayed in a variety of ways, such as loose (e.g., hanging garments), in boxes, or in bags. In many cases, a relatively small label must carry all the pertinent information relevant to the product. A retail label normally carries not only product-specific information important to the retailer (e.g., die lot, batch) and consumer related information (e.g., style, size, colour), but also the barcode itself.

Figure 6.5-1. Example barcode location on boxes

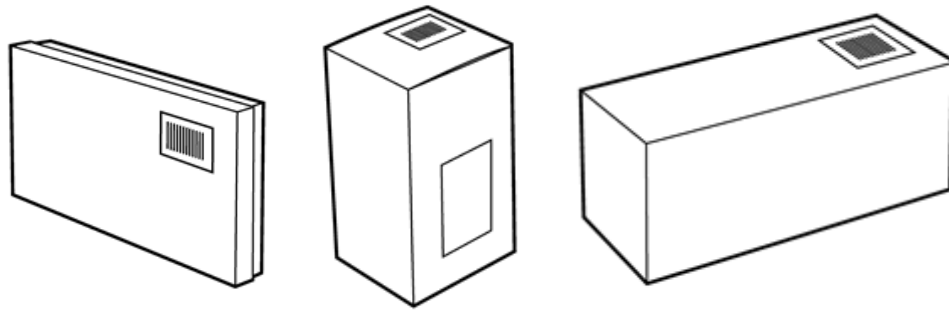

The correct general layout for a retail label is as follows. The label is divided into three portions:

- **Manufacturer/retailer information:** The upper portion of the format is the preferred location for non-HRI product information. This information is important to manufacturers and retailers, but usually not to the consumer.
- **Barcode:** The centre portion of the format is the best location for the barcode. Barcodes in this location are the least likely to present obstructions to scanners because a natural boundary exists between the manufacturer/retailer information (upper portion) and the consumer information (lower portion).
- **Consumer information:** The lower portion of the format is the preferred location for information that is provided for the consumer, such as price, size and fabric content.

The following sections show recommended placement of barcodes on clothing and fashion accessories. To view illustrative images, please visit:

https://www.gs1.org/docs/barcodes/GenSpec_Fashion_symbol_location.pdf

6.5.1 Information zones concept

There are seven information zones that carry product information needed for the vendor, retailer and consumer. Some information is optional based upon the type of label.

6.5.1.1 General label information zones

Zones	Information type	Description	Status: Required/Optional
Zone 1	Merchandise identification	This is the primary human readable merchandise identifier, usually the style number, although it may be pattern, model, or garment type. The merchandise identifier is located in the upper left-hand portion of Zone 1.	Always required (see Note)
Zone 2	Vendor information	This includes optional vendor production information, such as vendor stock keeping unit (SKU), cut number, dye lot, colour and pattern. (Vendor information helps ensure that the correct barcode is attached to the product.)	Optional
Zone 3	Data structure (GTIN-13, GTIN-12, GTIN-8)	Barcode(s)	Always required
Zone 4	Consumer information	This includes optional product information for the consumer, such as fibre content, fire retardancy and country of origin.	Optional
Zone 5	Size/dimension	Size/dimension is a key requirement for the consumer. Size information can be emphasised in large bold print and is located in the right-hand portion of Zone 5. Vendors may optionally include a style name as a selection aid for the consumer.	Usually required unless defined by the product (e.g., towels)

Zones	Information type	Description	Status: Required/Optional
Zone 6	Retail price	<p>Allow space to print the price with minimum dimension characters of 25 mm (1 in.) x 32 mm (1.25 in.). For plastic packaged, boxed and banded products, the required space for price can be provided by several methods:</p> <p>For barcode marking on an adhesive label, the space for price can be included as part of the label.</p> <p>For barcode marking designed into the packaging, the space for price can be included on the package artwork.</p> <p>Providing package space adjacent to Zone 5 that is reserved for retail item pricing creates an implied space for price. Implied space replaces the requirement for actual space on labels or package artwork.</p> <p>If implied space for price is used, no information of importance SHALL be printed in the area that might be covered by adhesive item price labels.</p>	Usually required unless defined by the ticket format (e.g., sewn-in tickets)
Zone 7	Manufacturer's suggested retail price	This is for use only if merchandise is pre-priced or the suggested retail price is printed on the tag. If provided, the area must be perforated for optional removal.	Optional
Note: Size and colour are optional in Zone 1 if vendor usage requires this information to define the product.			

6.5.1.2 General label format

See the figures [6.5.1.2-1](#) and [6.5.1.2-2](#) for examples of how the zones appear in a typical vertical and horizontal label format.

Figure 6.5.1.2-1. Vertical label format

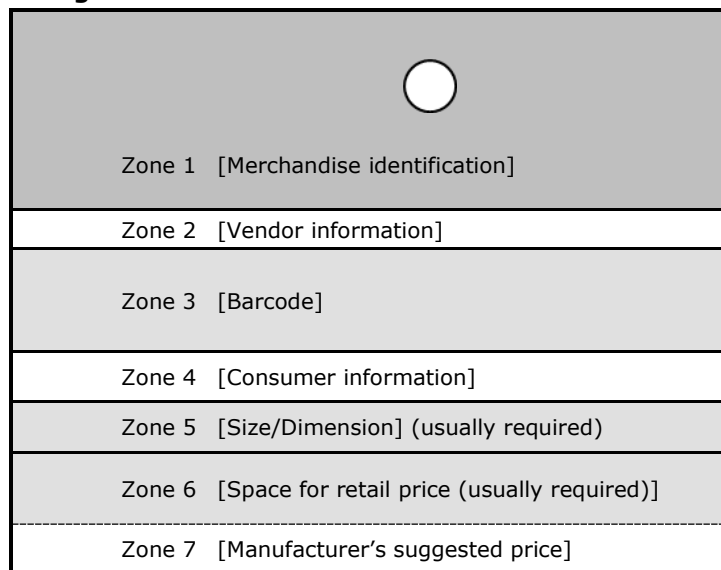
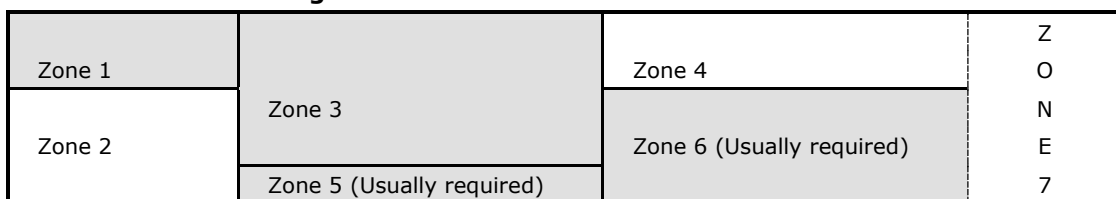

Figure 6.5.1.2-2. Horizontal label format



KEY	Required	Optional
-----	----------	----------

6.5.2 Hangtag (hanging label) format

Although hangtags (hanging labels) are primarily associated with hanging ready-to-wear apparel, a wide variety of products are identified with hangtags. Flat-folded apparel, jewellery, belts, handbags, lamps and furniture are all identified by some form of hangtag. Therefore, the voluntary hangtag format guidelines outlined in this section provide for flexibility in hangtag design while maintaining the overall concept of the information zones.

Hangtags serve a dual purpose. First, they provide brand identification to the consumer. Second, because the back of a hangtag is frequently used for product information and product identification codes, it SHALL carry the barcode that identifies the product.

The typical hangtag layout features the vendor's logo on the front and product identification codes and the barcode on the back. Vendors may optionally include an additional logo on the back of the hangtags. However, a logo SHALL NOT appear at the bottom because a retail price label may obscure it or it could be torn off if a manufacturer's suggested retail price is removed. Background printing of logos SHALL be avoided, because this may obscure required information or important consumer information. Logos must never obscure the barcode.

6.5.2.1 Hangtag label information zones

Zones	Information type	Description	Status: Required/ Optional
Zone 1	Merchandise identification	This is the primary human readable merchandise identifier, usually the style number, although it may be pattern, model, or garment type. The merchandise identifier SHALL be located in the upper left-hand portion of Zone 1.	Always required (see Note)
Zone 2	Vendor information	This includes optional vendor production information, such as vendor stock keeping unit (SKU), cut number, dye lot, colour and pattern. (Vendor information helps ensure that the correct barcode is attached to the product.)	Optional
Zone 3	Data structure (GTIN-13, GTIN-12, GTIN-8)	Barcode(s)	Always required
Zone 4	Consumer information	This includes optional product information for the consumer, such as fibre content, fire retardancy and country of origin.	Optional
Zone 5	Size/dimension	Size/dimension is a key requirement for the consumer. Size information can be emphasised in large bold print and is located in the right-hand portion of Zone 5. Vendors may optionally include a style name as a selection aid for the consumer.	Usually required unless defined by the product (e.g., towels)
Zone 6	Retail price	Allow space to print the price with minimum dimension characters of 25 mm (1 in.) x 32 mm (1.25 in.).	Usually required unless defined by the ticket format (e.g., sewn-in tickets)
Zone 7	Manufacturer's suggested retail price	This is for use only if merchandise is pre-priced or the suggested retail price is printed on the tag. If provided, the area must be perforated for optional removal.	Optional

Note: Size and colour are optional in Zone 1 if vendor usage requires this information to define the product.

6.5.2.2 Hanging tag label examples

Figure 6.5.2.2-1. Hanging tag examples

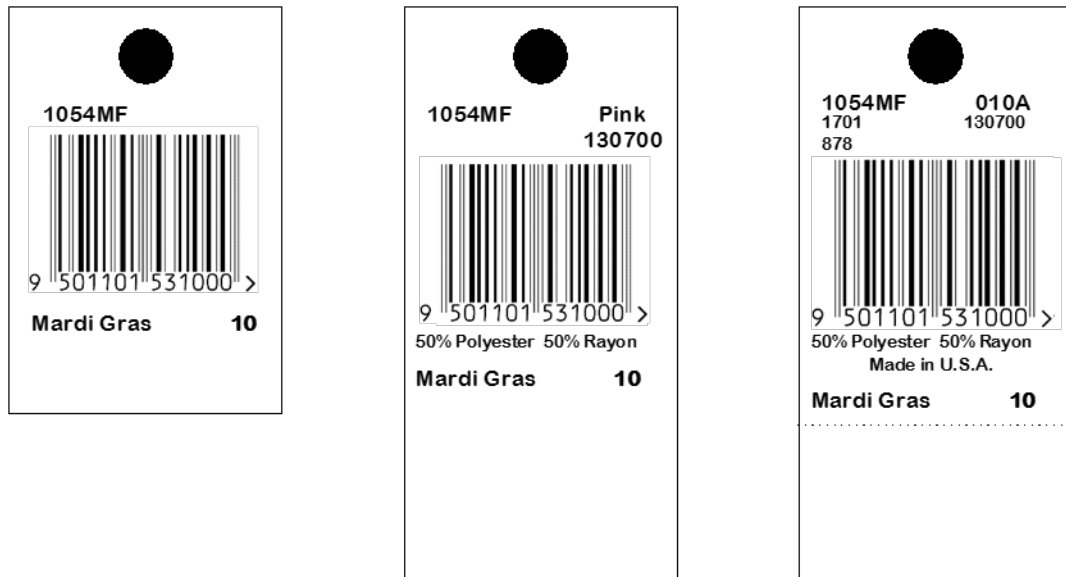

6.5.3 Sewn-on (joker) label format

Used almost exclusively for apparel merchandise, joker labels are similar in format to hangtags, but differ in one important respect: They are sewn directly onto the product instead of hung from the product. Because it is sewn on, only one side of the label is available for the vendor's logo, the barcode and merchandise identification information.

Inclusion of a vendor logo on the label is optional. If it is included, it SHALL NOT appear at the bottom, because it may be obscured by a retail price label, or it could be torn off by the removal of a manufacturer's suggested retail price. Background printing of logos SHALL be avoided, because this may obscure required information or important consumer information. Logos must never obscure the barcode.

6.5.3.1 Sewn-on (joker) label information zones

Zones	Information type	Description	Status: Required/Optional
Zone 1	Merchandise identification	This is the primary human readable merchandise identifier, usually the style number, although it may be pattern, model, or garment type. The merchandise identifier is located in the upper left-hand portion of Zone 1.	Always required (see Note)
Zone 2	Vendor information	This includes optional vendor production information, such as vendor stock keeping unit (SKU), cut number, dye lot, colour and pattern. (Vendor information helps ensure that the correct barcode is attached to the product.)	Optional
Zone 3	Data structure (GTIN-13, GTIN-12, GTIN-8)	Barcode(s)	Always required
Zone 4	Consumer information	This includes optional product information for the consumer, such as fibre content, fire retardancy and country of origin.	Optional

Zones	Information type	Description	Status: Required/Optional
Zone 5	Size/dimension	Size/dimension is a key requirement for the consumer. Size information can be emphasised in large bold print and SHALL be located in the right-hand portion of Zone 5. Vendors may optionally include a plain language style name on the size line as a selection aid for the consumer.	Usually required unless defined by the product (e.g., towels)
Zone 6	Retail price	Allow space to print the price with minimum dimension characters of 25 mm (1 in.) x 32 mm (1.25 in.).	Usually required unless defined by the ticket format (e.g., sewn-in tickets)
Zone 7	Manufacturer's suggested retail price	This is for use only if merchandise is pre-priced or the suggested retail price is printed on the tag. If provided, the area must be perforated for optional removal.	Optional

Note: Size and colour are optional in Zone 1 if vendor usage requires this information to define the product.

6.5.3.2 Sewn-on (joker) label examples

Figure 6.5.3.2-1. Vertical layout

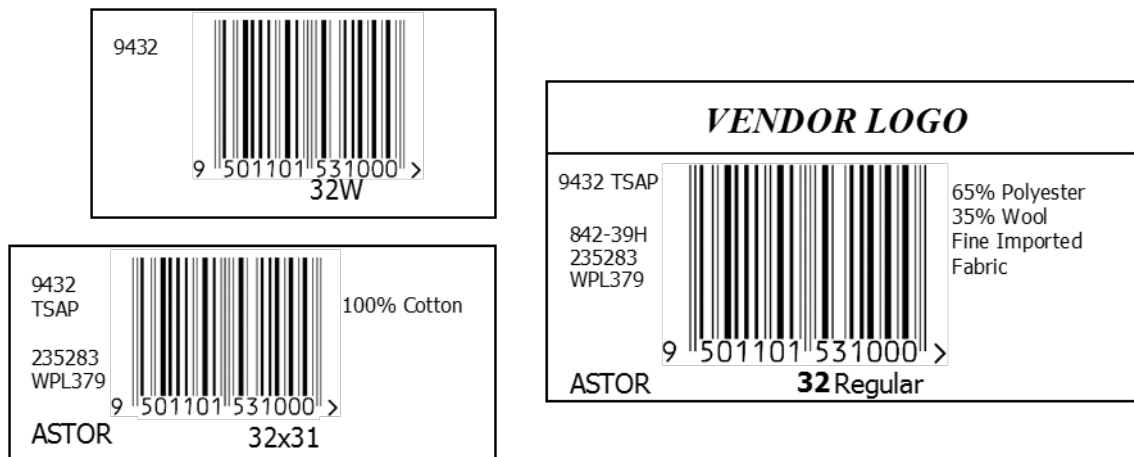

Figure 6.5.3.2-2. Horizontal layout

6.5.4 Sewn-in label formats

Sewn-in labels are often used for towel products. Sewn-in labels may be paper based, for removal by the consumer, or cloth based and more permanent.

Because a portion of the sewn-in label is normally covered by a hem, the label SHALL be designed with sufficient blank space on the end that will be attached to the product. Care must be taken to ensure that the product identification information on the label is not obscured by the hem and that it does not interfere with the readability of the barcode at the point-of-sale (POS).

6.5.4.1 Sewn-in label information zones

Zones	Information Type	Description	Status: Required/Optional
Zone 1	Merchandise identification	This is the primary human readable merchandise identifier, usually the style number, although it may be pattern, model, or garment type. The merchandise identifier is located in the upper left-hand portion of Zone 1.	Always required (see Note)
Zone 2	Vendor information	This includes optional vendor production information, such as vendor stock keeping unit (SKU), cut number, dye lot, colour and pattern. (Vendor information helps ensure that the correct barcode is attached to the product.)	Optional
Zone 3	Data structure (GTIN-13, GTIN-12, GTIN-8)	Barcode(s)	Always required
Zone 4	Consumer information	This includes optional product information for the consumer, such as fibre content, fire retardancy and country of origin.	Optional
Zone 5	Size/dimension	Size or dimension is optional for sewn-in labels. Size or dimension may assist the consumer with product selection or may help the vendor ensure that the correct label and barcode are attached to the product.	Usually required unless defined by the product (e.g., towels) and readily apparent to the consumer.
Zone 6	Retail price	Allow space to print the price with minimum dimension characters of 25 mm (1 in.) x 32 mm (1.25 in.).	Usually required unless defined by the ticket format (e.g., sewn-in tickets)
Zone 7	Manufacturer's suggested retail price	This is for use only if merchandise is pre-priced or the suggested retail price is printed on the tag. If provided, the area must be perforated for optional removal.	Optional

Zones	Information Type	Description	Status: Required/Optional
Note: Size and colour are optional in Zone 1 if vendor usage requires this information to define the product.			

6.5.5 Plastic packaged products label location guidelines

The plastic packaged category covers a wide assortment of merchandise, including sheets, pillowcases, table linens, pantyhose, underwear, stationery supplies, pillows, bedspreads and numerous types of flat-folded apparel that are plastic packaged. There are two methods of marking plastic packaged products with barcodes:

1. Incorporate the barcode and other merchandise identification information into the packaging’s artwork.
2. Print the barcode and other merchandise identification information on an adhesive label that can be press-applied to the product.

Inclusion of a vendor logo on the label is optional. If it is included, the logo SHALL NOT appear at the bottom, because it may be obscured by a retail price label, or it could be torn off by the removal of a manufacturer’s suggested retail price. Background printing of logos SHALL be avoided, because this may obscure required information or important consumer information. Logos must never obscure the barcode.

6.5.5.1 Plastic packaged products label information zones

Zones	Information Type	Description	Status: Required/Optional
Zone 1	Merchandise identification	This is the primary human readable merchandise identifier, usually the style number, although it may be pattern, model, or garment type. The merchandise identifier is located in the upper left-hand portion of Zone 1.	Always required (see Note 1)
Zone 2	Vendor information	This includes optional vendor production information, such as vendor stock keeping unit (SKU), cut number, dye lot, colour and pattern. (Vendor information helps to ensure that the appropriate barcode is attached to the product.)	Optional
Zone 3	Data structure (GTIN-13, GTIN-12, GTIN-8)	Barcode(s)	Always required
Zone 4	Consumer information	This includes optional product information for the consumer, such as fibre content, fire retardancy and country of origin.	Optional (see Note 2)
Zone 5	Size/dimension	Size/dimension is a key requirement for the consumer. Size information can be emphasised in large bold print and is located in the right-hand portion of Zone 5. Vendors may optionally include a style name as a selection aid for the consumer.	Usually required (see Note 3)

Zones	Information Type	Description	Status: Required/Optional
Zone 6	Retail price	<p>Allow space to print the price with 25 mm (1 in.) x 32 mm (1.25 in.) minimum dimension characters. For plastic packaged products, this required space for price can be provided by several methods:</p> <p>For barcode marking on an adhesive label, the space for price can be included as part of the label.</p> <p>For barcode marking designed into the packaging, the space for price can be included on the package artwork.</p> <p>Providing package space adjacent to Zone 5 that is reserved for retail item pricing creates an implied space for price. Implied space replaces the requirement for actual space on labels or package artwork.</p> <p>If implied space for price is used, no information of importance SHALL be printed in the area that might be covered by adhesive item price labels.</p>	Usually required
Zone 7	Manufacturer's suggested retail price	This is for use only if merchandise is pre-priced or the suggested retail price is printed on the tag. If provided, the area must be perforated for optional removal.	Optional
<p>Note 1: Size and colour are optional in Zone 1 if vendor usage requires this information to define the product.</p> <p>Note 2: Some jurisdictions require that certain products include a permanently affixed statement of information of this type in Zone 4 that may not be satisfied by inclusion on the package.</p> <p>Note 3: Size may be omitted from Zone 5 if the size information is readily available on the product packaging.</p>			

6.5.5.2 Plastic packaged products label placement guidelines

Consistent barcode placement is required for successful scanning at the POS. The barcode placement guidelines for plastic packaged products have been designed with the flexibility to accommodate differences that may arise from industry to industry:

- On plastic packaged products, the front top right-hand corner is the preferred placement for the barcode and other product identification information.
- The barcode and other product identification information may be located on the front or back of plastic packaged products. However, all products within a particular merchandise category must have their barcodes placed on the same side of the package.

! **Caution:** Placement of the barcode on the back of a product may result in the presentation of the product on the display counter in a backside up orientation by some retailers so that the barcode and retail price appear together in full view by the customer.

- The orientation of the barcode and other product identification information SHALL be consistent with any graphics or descriptive data on the plastic package.
- Where possible, the barcode and other product identification information, whether built into the package artwork or an adhesive label, must not be closer than 8 millimetres (0.3 inch) or farther than 100 millimetres (4 inches) from the nearest edge of the package. Experience has shown that the previously recommended minimum distance of 5 millimetres (0.2 inch) is inadequate. Also, cashiers often grab packages on the edge with their thumbs. Avoid placing the barcode too close to the edge. Such placement reduces POS efficiency and may cause distortion of the barcode. (See section [6.3.3.3](#), *Edge rule*.)
- The barcode and other product identification information on plastic packaged products is normally to be located on the front top right-hand corner. However, for very large, bulky, or unusually shaped products, this may be impractical or inappropriate. See section [6.4.9](#) for information on large, heavy and bulky items.

✓ **Note:** Section [6.4](#) specifies the lower right quadrant of the back of the package or container as the recommended location for the barcode. This recommendation applies to plastic packaged products that are sold in a grocery store environment.

6.5.5.3 Plastic packaged products label example

Figure 6.5.5.3-1. Plastic packaged products label example

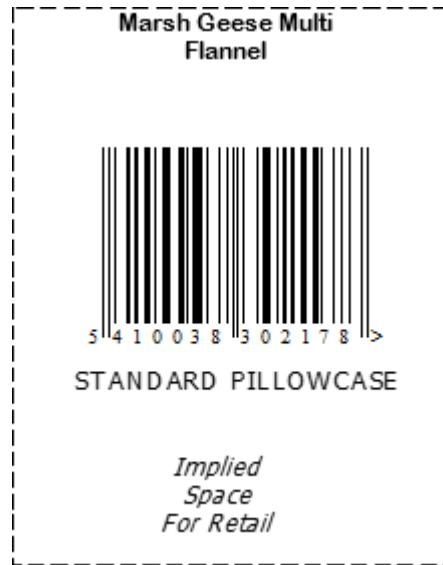

6.5.6 Boxed products label formats

Some boxed products may be sold in or out of the box. Other boxed products are actually sets that may also be sold as individual items. Some boxes carry significant amounts of design graphics, while others are plain boxes containing the product.

Box size can range from very small, as in jewellery or cosmetics, to very large, as in home furnishings. For extremely large boxed products, consider using a two-part tear-off barcode label to facilitate scanning at the POS while leaving one label on the box.

There are two methods of marking boxed products with barcodes:

- Incorporate the barcode and other merchandise identification information the box’s artwork.
- Print the barcode and other merchandise identification information on an adhesive label that can be affixed to the box.

Inclusion of a vendor logo in the box marking format is optional. If the logo is included, it SHALL NOT appear at the bottom, because it may be obscured by a retail price label, or it could be torn off if a manufacturer's suggested retail price is removed. Background printing of logos SHALL be avoided, because this may obscure required information or important consumer information.

6.5.6.1 Boxed products label information zones

Zones	Information Type	Description	Status: Required/Optional
Zone 1	Merchandise identification	This is the primary human readable merchandise identifier, usually the style number, although it may be pattern, model, or garment type. The merchandise identifier is located in the upper left-hand portion of Zone 1.	Always required (see Note 1)
Zone 2	Vendor information	This includes optional vendor production information, such as vendor stock keeping unit (SKU), cut number, dye lot, colour and pattern. (Vendor information helps ensure that the correct barcode is attached to the product.)	Optional
Zone 3	Data structure (GTIN-13, GTIN-12, GTIN-8)	Barcode(s)	Always required

Zones	Information Type	Description	Status: Required/Optional
Zone 4	Consumer information	This includes optional product information for the consumer, such as fibre content, fire retardancy and country of origin.	Optional (see Note 2)
Zone 5	Size/dimension	Size/dimension is a key requirement for the consumer. Size information can be emphasised in large bold print and is located in the right-hand portion of Zone 5. Vendors may optionally include a style name as a selection aid for the consumer.	Usually required (see Note 3)
Zone 6	Retail price	<p>Allow space to print the price with minimum dimension characters of 25 mm (1 in.) x 32 mm (1.25 in.). For boxed products, this required space for price can be provided by several methods:</p> <p>For barcode marking on an adhesive label, the space for price can be included as part of the label.</p> <p>For barcode marking designed into the packaging, the space for price can be included on the package artwork.</p> <p>Providing package space adjacent to Zone 5 that is reserved for retail item pricing creates an implied space for price. Implied space replaces the requirement for actual space on labels or package artwork.</p> <p>If implied space for price is used, no information of importance is printed in the area that might be covered by adhesive item price labels.</p>	Usually required
Zone 7	Manufacturer's suggested retail price	For use only if merchandise is pre-priced or the suggested retail price is printed on the tag. If provided, the area must be perforated for optional removal.	Optional
<p>Note 1: Size and colour are optional in Zone 1 if vendor usage requires this information to define the product.</p> <p>Note 2: Some jurisdictions require that certain products include a permanently affixed statement of information of this type in Zone 4 that may not be satisfied by inclusion on the package.</p> <p>Note 3: Size may be omitted from Zone 5 if the size information is readily available on the product packaging.</p>			

6.5.6.2 Packaged versus freestanding single selling units

Certain single selling units (trade items) may be sold as freestanding items, or they may be sold in a package. This creates a dilemma for the supplier: to mark the item or mark the package? For the definition of a trade item pertaining to this scenario, see section [2.1](#).

6.5.6.3 Boxed products label placement guidelines

Consistent barcode placement within an industry or product category is required if merchandise carrying a barcode is to successfully scan at the POS. Since the category of boxed products includes a diverse merchandise group, location guidelines have been designed with considerable flexibility to accommodate differences that may arise from industry to industry:

- The exposed surface of the box is the preferred location for barcodes and other product identification information on boxed products sold primarily in the department or specialty store environment.
- The orientation of the barcode and other product identification information SHALL be consistent with any graphics or descriptive data on the box.
- Where possible, the barcode and other product identification information, whether built into the package artwork or an adhesive label, must not be closer than 8 millimetres (0.3 inch) or farther than 100 millimetres (4 inches) from the nearest edge of the package. Experience has shown that the previously recommended minimum distance of 5 millimetres (0.2 inch) is inadequate. Also, cashiers often grab packages on the edge with their thumbs. Avoid placing the barcode too close to the edge. Such placement reduces POS efficiency and may cause distortion of the barcode. (See section [6.3.3.3](#), *Edge rule*.)
- The barcode and other product identification information on plastic packaged products is normally to be located on the front top right-hand corner. However, for very large, bulky, or

unusually shaped products, this may be impractical or inappropriate. See section [6.4.9](#) for information on large, heavy and bulky items.

- Note:** Section [6.4](#) specifies the lower right quadrant of the back of the package or container as the recommended location of the barcode. This recommendation applies to plastic packaged products that are sold in a grocery store environment.

6.5.6.4 Boxed products label examples

Figure 6.5.6.4-1. Label examples for boxed products

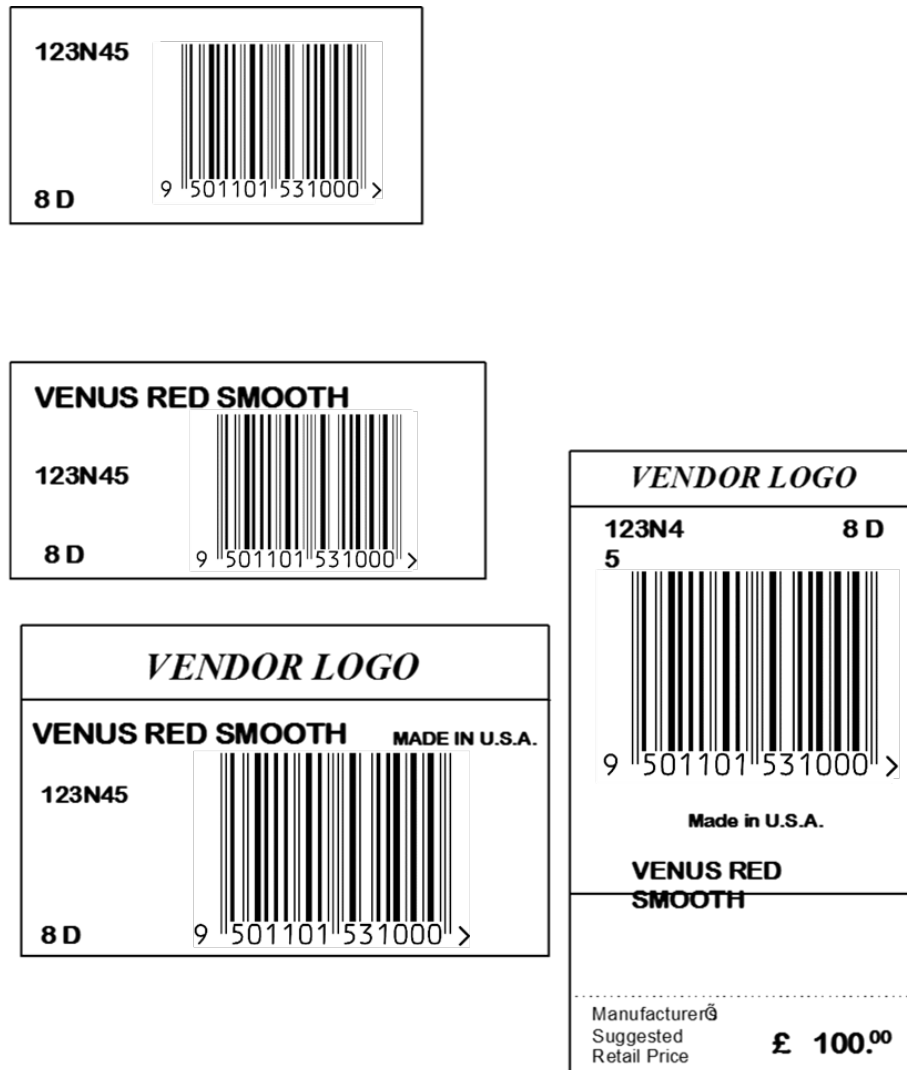

6.5.7 Banded products label formats

Banded packaging involves a specialised group of products. This type of packaging is most commonly associated with hosiery (socks) or yarn products. There are the two methods of marking banded products with barcodes:

- Incorporate the barcode and other merchandise identification information into the band's artwork.
- Print the barcode and other merchandise identification information on an adhesive label that can be applied to the band.

The typical banded product label has the vendor's logo on the front and the product identification codes, consumer information and barcode on the back. The vendor's logo can also be printed on the back of the band as part of the band marking format. However, care **MUST** be taken to ensure that there is no obstruction of the barcode or other important product identification information. Background printing of logos **SHALL** be avoided.

6.5.7.1 Banded products label information zones

Zones	Information Type	Description	Status: Required/Optional
Zone 1	Merchandise identification	This is the primary human readable merchandise identifier, usually the style number, although it may be pattern, model or garment type. The merchandise identifier is in the upper left-hand portion of Zone 1.	Always required (see Note 1)
Zone 2	Vendor information	This includes optional vendor production information, such as vendor stock keeping unit (SKU), cut number, dye lot, colour and pattern. (Vendor information helps ensure that the correct barcode is attached to the product.)	Optional
Zone 3	Data structure (GTIN-13, GTIN-12, GTIN-8)	Barcode(s)	Always required
Zone 4	Consumer information	This includes optional product information for the consumer, such as fibre content, fire retardancy and country of origin.	Optional (see Note 2)
Zone 5	Size/dimension	Size/dimension is a key requirement for the consumer. Size information can be emphasised in large bold print and is in the right-hand portion of Zone 5. Vendors may optionally include a style name as an aid to the consumer in selection.	Usually required (see Note 3)
Zone 6	Retail price	<p>Allow space to print the price with minimum dimension characters of 25 mm (1 in.) x 32 mm (1.25 in.). For banded products, this required space for price can be provided by several methods:</p> <p>For barcode marking on an adhesive label, the space for price can be included as part of the label.</p> <p>For barcode marking designed into the packaging, the space for price can be included on the package artwork.</p> <p>Providing package space adjacent to Zone 5 that is reserved for retail item pricing creates an implied space for price. Implied space replaces the requirement for actual space on labels or package artwork.</p> <p>If implied space for price is used, no information of importance is printed in the area that might be covered by adhesive item price labels.</p>	Usually required
Zone 7	Manufacturer's suggested retail price	This is for use only if merchandise is pre-priced or the suggested retail price is printed on the tag. If provided, the area must be perforated for optional removal.	Optional
<p>Note 1: Size and colour are optional in Zone 1 if vendor usage requires this information to define the product.</p> <p>Note 2: Some jurisdictions require that certain products include a permanently affixed statement of information of this type in Zone 4 that may not be satisfied by inclusion on the package.</p> <p>Note 3: Size may be omitted from Zone 5 if the size information is readily available on the product packaging.</p>			

6.6 GS1 Logistic Label design

These specifications constitute the basis for all GS1 Logistic Labels. Other sections, most notably section [3](#) *GS1 Application Identifier*, section [5.4](#) *GS1-128*, section [5.6](#) *GS1 DataMatrix* and section [5.7](#) *GS1 QR Code*, **SHALL** be read in conjunction with the following sub-sections.

6.6.1 Scope

These specifications detail the structure and layout of GS1 Logistic Labels. Emphasis is given to the basic requirements for practical application in an open trade environment. Primary topics include:

- The unambiguous identification of logistic units.
- The efficient presentation of text and machine readable data.
- The information requirements of the key partners in the supply chain: suppliers, customers and carriers.
- Technical parameters to ensure systematic and stable interpretation of labels.

6.6.2 Concepts

6.6.2.1 Logistics information flow

As a logistic unit moves through the supply chain, a series of events occurs that defines the information related to the unit. The whole supply chain process of manufacturing, finished goods distribution, transportation and deployment into the marketplace adds layers of information related to the logistic unit.

For example, the physical content of the unit is typically defined at finished goods distribution. At that point in time the identification of the logistic unit as an entity is possible. Other elements of information, such as final destination or the composition of a multi-unit shipment, are not typically known until later in the supply chain process. In a trading relationship, different elements of information are generally known and applied by the supplier, carrier and customer.

Figure 6.6.2.1-1. Logistics information flow

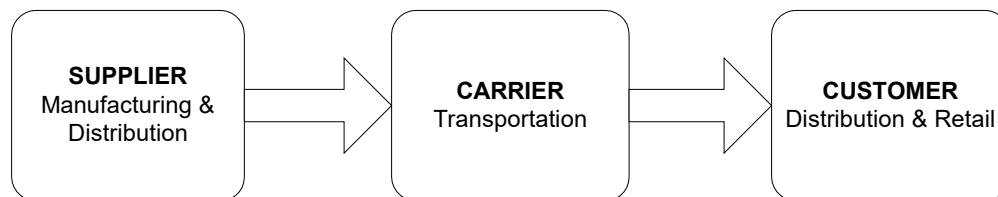

6.6.2.2 Representation of information

The information included on a GS1 Logistic Label comes in two basic forms.

1. Information to be used by people: This is comprised of HRI, non-HRI text and graphics.
2. Information designed for data capture by a machine: Barcodes.

Barcodes are machine readable and are a secure and efficient method for conveying structured data, while HRI, non-HRI text and graphics allow people general access to basic information at any point in the supply chain. Both methods add value to GS1 Logistic Labels and often co-exist on the same label.

6.6.3 GS1 Logistic Label design

The GS1 Logistic Label information may be grouped into logical segments for the supplier, customer and carrier. Each label segment may be applied to the logistic unit at a different point in time as the relevant information becomes known.

In addition to this, on the GS1 Logistic Label a distinction can be made between the types of data communicated on the GS1 Logistic Label, in order to facilitate interpretation by machines and people. For this purpose the data can be expressed in three types of building blocks.

The SSCC is the single mandatory element for all GS1 Logistic Labels. Other information, when required, SHALL comply with the specifications in this document and with the proper use of GS1 Application Identifiers.

6.6.3.1 Building blocks

The GS1 Logistic Label comprises three building blocks:

1. The top building block may contain anything, e.g., text and graphics. This may include extra information about the logistic unit that is not encoded in the barcode(s).
2. The middle building block contains non-HRI text reflecting the information represented in the barcode(s) using data titles rather than AIs and optionally additional information not represented in barcodes (preferably including data titles).
3. The bottom building block contains the barcode(s) including human readable interpretation (HRI).

Only the bottom building block is mandatory.

A 2D barcode, if used, SHOULD be placed to the right of the non-HRI text including data titles within the middle building block. See option 2 in the figure below.

If there is enough space, the lower two building blocks may be placed side by side. See option 3 in figure below.

Figure 6.6.3.1–1. Placement of building blocks

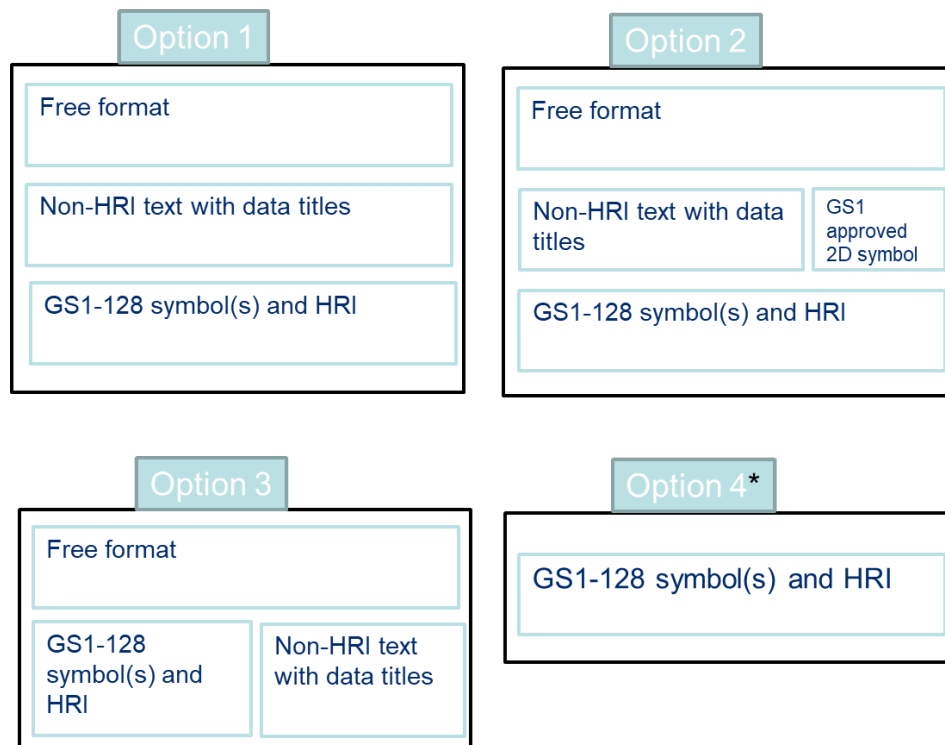

*Minimum requirement

6.6.3.2 Segments

A segment is a logical grouping of information that is generally known at a particular time. There may be up to three label segments on a GS1 Logistic Label, each representing a group of information. Generally, the order of the segments, from top to bottom, is: carrier (transport), customer and supplier. However, this order and top/down alignment may vary depending on the size of the logistic unit and the business process being served.

Each segment may contain a combination of the defined building blocks as determined by trading partners.

Segments may be printed as separate labels, in which case they must be placed vertically in close proximity of each other, with the segment containing the SSCC at the bottom. The carrier segment may be replaced during the journey of the logistic unit, in which case special care should be taken to ensure the customer and supplier segments are preserved.



Note: (informative) See the *GS1 Logistic Label Guideline* for examples of some different segmented labels.

6.6.3.2.1 Supplier segment

The supplier segment of the label contains information that is generally known at the time of packaging by the supplier. The SSCC is applied here as the logistic unit identifier, along with the Global Trade Item Number (GTIN) if included on the label.

Other information that may be of interest to the supplier but might also be useful for customers and carriers can be applied. This includes product-related information such as product variant; dates such as production, packaging, expiration and best-before dates; and lot, batch and serial numbers.

6.6.3.2.2 Customer segment

The customer segment of the label contains information that is generally known at the time of order and order processing by the supplier. Typical information includes the ship to location, purchase order number and customer-specific routing and handling information. If several logistic units are assembled to be transported under one despatch advice or Bill of Lading (BOL) to one customer the GSIN, AI (402), may also be applied in this customer segment.

6.6.3.2.3 Carrier (transport) segment

The carrier (transport) segment of the label contains information that is generally known at the time of shipment and is typically related to transport. Typical information includes ship to postal codes, AI (420), Global Identification Number for Consignment, AI (401) and carrier-specific routing and handling information.

6.6.4 Technical specifications

6.6.4.1 Barcodes and HRI

6.6.4.1.1 Barcode orientation and placement

GS1-128 barcodes SHALL be placed in a picket fence orientation relative to the base of a logistic unit, this means, the bars and spaces are perpendicular to the base on which the logistic unit stands. In all cases, the GS1-128 barcode encoding the SSCC SHALL be placed in the lowest portion of the label.

A 2D barcode, if used, SHOULD be placed immediately to the right of the middle building block. When a 2D barcode is used, the barcode's quiet zone requirements must be respected.

6.6.4.1.2 HRI

As a back-up key entry and diagnostic aid, a human readable interpretation (HRI) of each barcode element string encoded in a GS1-128 SHALL be provided. For each element string included in a 2D barcode that is not present in a GS1-128 barcode on the label either HRI associated with the 2D barcode(s) or non-HRI text with data titles SHALL be provided. For more information see the general HRI rules for barcodes in section [4.14](#).

6.6.4.2 Non-HRI text including data titles

Text with data titles is non-HRI text designed to support manual operations and to facilitate key entry in menu driven systems. It may be used to specify the text equivalent of the data elements represented in barcodes and is comprised of data titles and data content. The data content SHOULD

be at least 7 millimetres/0.275 inches in height. If there is no other language agreed between trading partners, data titles must be printed in English. As an option left at the discretion of the labeller, a second language can be added.

6.6.4.3 Data titles

Data titles are the standard abbreviated descriptions of element strings, used to support the manual interpretation of encoded data. Data titles SHOULD be used adjacent to all data fields included in the middle building block. Data titles may also be used adjacent to barcodes and HRI.

All data titles are shown in section [3.2](#).

6.6.4.4 Free format

Free format information may be comprised of non-HRI text and graphics. The name and address of the sender and receiver are typical examples of non-HRI text. Company logos and instruction pictograms are examples of graphics. All non-HRI text included in the top building block SHALL be clearly legible and no less than 3 millimetres/0.118 inches high.

6.6.4.5 Label dimensions

The physical dimensions of the label are determined by the labeller, but the size of the label should be consistent with the data requirements of the label. Factors influencing label dimensions include the amount of data required, the content and X-dimension of the barcodes used and the dimensions of the logistic unit to be labelled. The business requirements for most users of GS1 Logistic Labels are met by using one of following:

- A6 (105 mm x 148 mm), which is particularly suitable when only the SSCC, or the SSCC and limited additional data, is encoded.
- 4 x 6 inch, which is particularly suitable when only the SSCC, or the SSCC and limited additional data, is encoded.

-or-

- A5 (148 mm x 210 mm).
- 6 x 8 inch.

6.6.4.6 Label location

Label placement specifications are maintained in section [6.7](#).

6.6.5 Label examples

Figure 6.6.5-1. The basic label: an SSCC



Notes:

This example shows a label containing only an SSCC. Such labels can be applied at production time, but also during transport or receipt in case no label is present on the logistic unit.

Building blocks (top-down):

- Middle block (Text with data titles): SSCC.
- Bottom block (Barcodes + HRI): AI (00).

Figure 6.6.5-2. Label with combined supplier and carrier information

Von/From Mustermann GmbH Herr Schmidt Hauptstr. 35 60100 Frankfurt Germany	An/To Edificio de Servicios Generales Ms Alicia Romero Calle Centella 18 08820 Barcelona Spain
SSCC 395011015300000011 ROUTE GINC 402621 950110153B01001 Dimensions / Weight: 80x20x20 cm / 50,0 kg Billing No.: 5020613963 69 01	
 (403)402621(401)950110153B01001  (00)395011015300000011	

Notes:

This example shows a pallet label that may be applied at the time of transport. Besides information on the logistic unit it contains information on the route and destination.

Building blocks (top-down):

- Top block: Von/From; An/To.
- Middle block (text with data titles): SSCC; ROUTE; Dimensions/Weight; Billing No.
- Bottom block (barcodes and HRI): AI (403); AI (401); AI (00).

Figure 6.6.5-3. Label with supplier and carrier segments

FROM BIG SUPPLIER 5th AVENUE NEW YORK USA	TO GREAT VALUE 8163 NEW CAJUN DAYTON, OHIO USA
SHIP TO POST  (420) 45458	CARRIER Best Freight B/L 853903 PRO 2895769860
SSCC  (00) 0 0614141 123456789 0	

Notes:

This example shows a case label that may be applied at the time of transport. Besides the SSCC it contains information on the route and destination.

Segments and building blocks (top-down):

- Carrier segment (middle block and bottom block side by side):
 - Top block: FROM; TO.
 - Middle block (text with data titles): CARRIER; B/L; PRO.
 - Bottom block (barcodes and HRI): SHIP TO POST.
- Supplier segment:
 - Bottom block (barcodes and HRI): SSCC; AI (00).

Figure 6.6.5-4. Label with supplier information

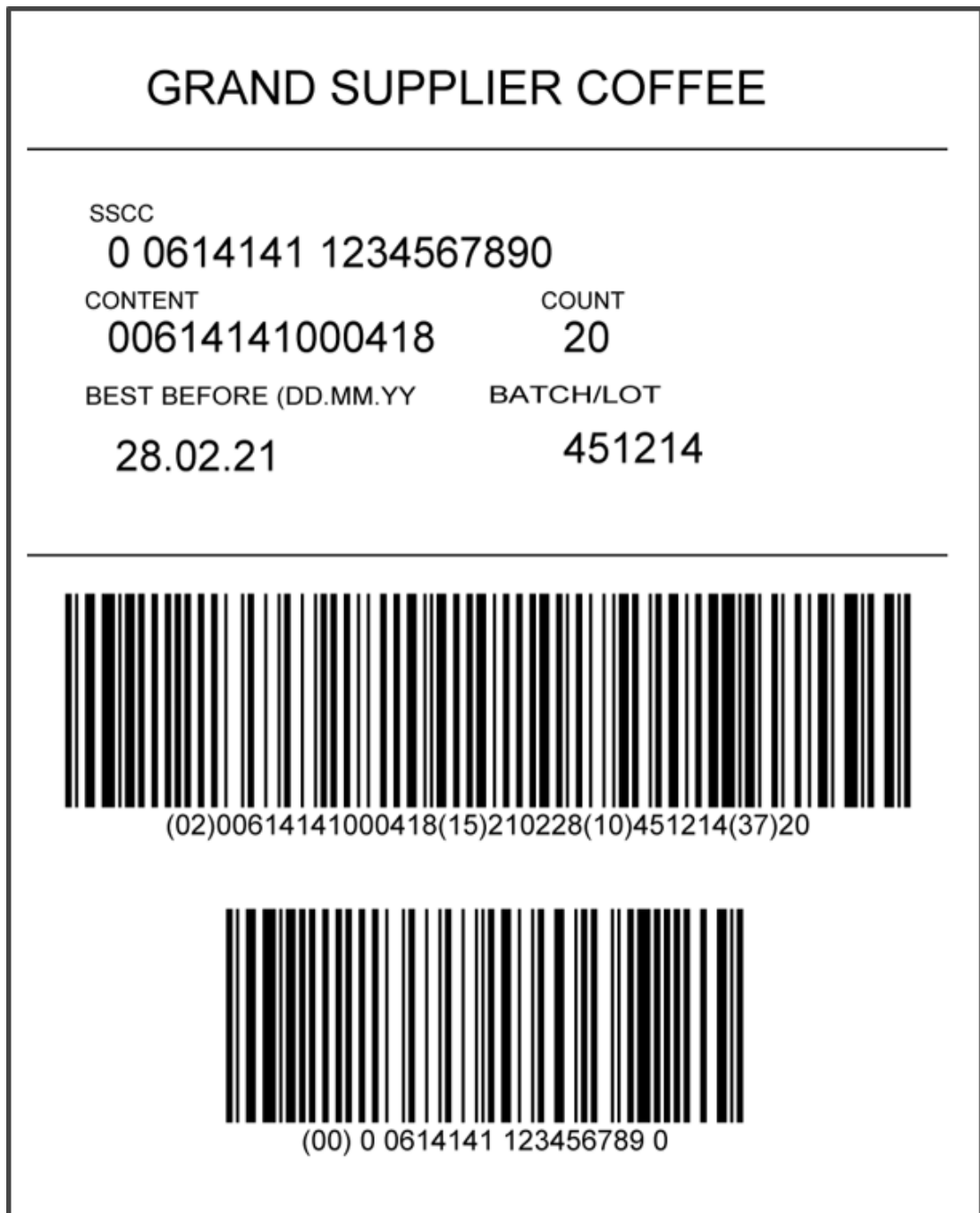

Notes:

This example shows a pallet label that may be applied at the time of production. It contains information on the supplier and the trade item, but no information on the transport and customer.

Building blocks (top-down):

- Top block: SUPPLIER NAME.
- Middle block (text with data titles): SSCC; CONTENT; COUNT; BEST BEFORE; BATCH.
- Bottom block (barcodes and HRI): AI (02); AI (15); AI (10); AI (37); AI (00).

Figure 6.6.5-5. Label with supplier, customer and carrier segments

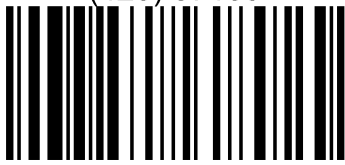
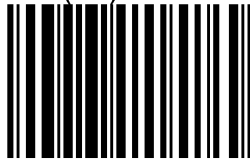
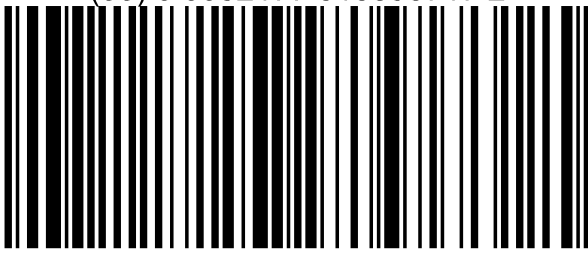
FROM Good Time Supplier 1155 Battery St San Fransisco CA 94111		TO Customer DC 1478 5241 San Antonio Dr Albuquerque, NM 87109	
SHIP TO POST (420) 87109 		CARRIER Best Freight PRO: 2895769860 B/L: 853930	
PO: 345-896779-0 DEPT: 092			
Store Number (90) 1528 		Customer Store 1528 1815 N Main Roswell NM 87109	
SSCC (00) 0 0052177 513895717 2 			

Notes:

This example shows a case label that may be applied in a cross-docking scenario. Besides the SSCC it contains transport information and information on the final customer destination.

Segments and building blocks (top-down):

- Carrier segment (middle block and bottom block side by side):
 - Top block: FROM; TO.
 - Middle block (text with data titles): Carrier; B/L; PRO.
 - Bottom block (barcodes and HRI): SHIP TO POST.
- Customer segment:
 - Top block: PO; DEPT.
 - Middle block (text with data titles): Customer.
 - Bottom block (barcodes and HRI): Store Number.
- Supplier segment:
 - Bottom block (barcodes and HRI): SSCC; AI (00).

Figure 6.6.5-6. Label with GS1-128 and GS1 DataMatrix barcodes

FJP CARRIERS								
FROM	GS1 Avenue Louise 326 1050 BE BRUXELLES BE - Belgique GLN: 9501101100015 ☎ +32 123456789							
TO	Hr. F. van den Bim Kerkstraat 319 1500 KM Wormerveer NL - Nederland							
✍								
ROUTE	<table style="width: 100%; border: none;"> <tr> <td style="width: 30%;">SSCC</td> <td style="width: 40%;">39501101 001300012 9</td> <td rowspan="3" style="text-align: center; vertical-align: middle;"></td> </tr> <tr> <td>ROUTE</td> <td>123+1021JK+0320+12</td> </tr> <tr> <td>SHIP TO POST</td> <td>528 1500KM</td> </tr> </table>	SSCC	39501101 001300012 9		ROUTE	123+1021JK+0320+12	SHIP TO POST	528 1500KM
SSCC	39501101 001300012 9							
ROUTE	123+1021JK+0320+12							
SHIP TO POST	528 1500KM							
SSCC	 (00) 3 9501101 001300012 9							

Notes:

This example shows a label that may be applied in a parcel delivery scenario.

Building blocks (top down):

- Top block: Transport Carrier, From address with phone number, To address
- Middle block (text with data titles): SSCC, Routing Code, Ship to – Deliver to postal code with country code
 GS1 DataMatrix: AI (00), AI (403), AI (421)
- Bottom block (barcodes and HRI): AI (00)

Figure 6.6.5-7. Label with GS1 DataMatrix and GS1-128 barcodes

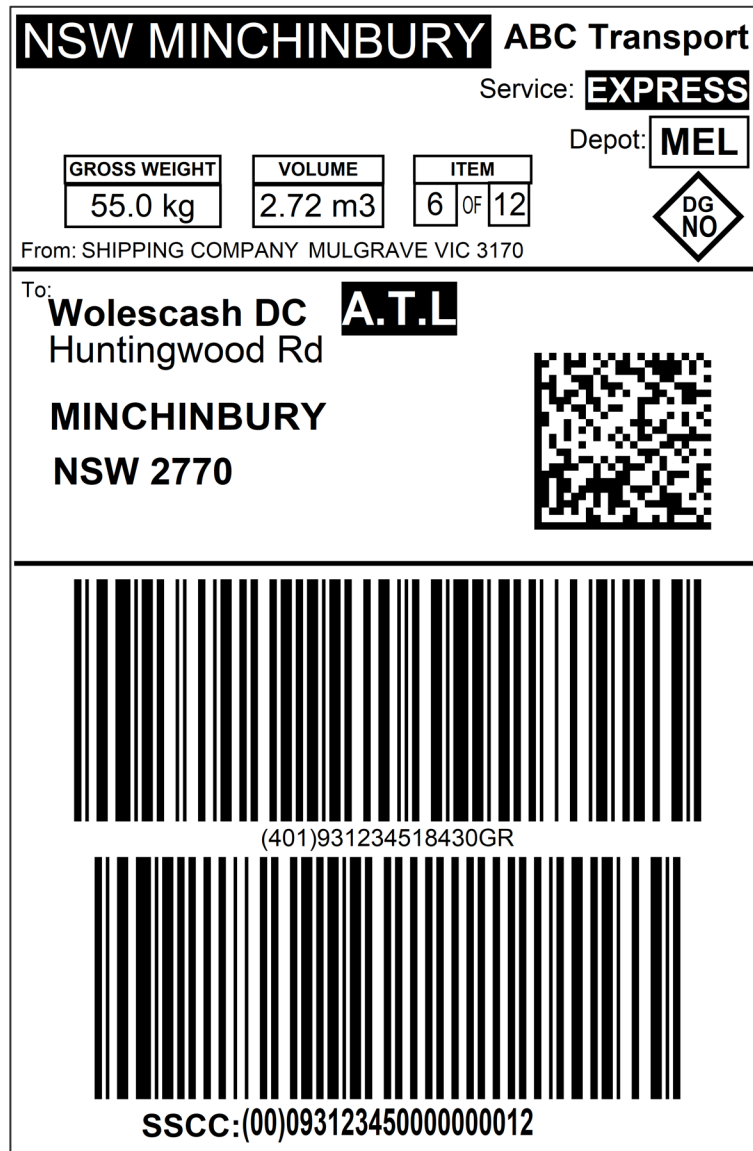

Notes:

This example shows a label created specifically for transport purposes. No product information is included.

Building blocks (top-down):

- Top block: Transport Company, Weight, Volume, Item count, Service class
- Middle block:
 - GS1 DataMatrix: AI (00), AI (421), AI (401), AI (403),
- Bottom block (barcodes and HRI): AI (401); AI (00)

Figure 6.6.5-8 Label GS1 DataMatrix encoding transport process information



Notes:

This example shows a label that may be applied in a parcel delivery scenario with transport process information encoded in a 2D barcode.

- Top block – Transport carrier, From address with phone number, To address
- Middle Block (text with data title) – SSCC, Routing Code, Ship-to / Deliver-to postal code with country code, GS1 DataMatrix with transport process information
- Bottom block (barcode and HRI)– AI (00)

6.7 Barcode placement used in general distribution

General distribution scanning items include any item handled as a single unit in the transport and distribution process. This definition covers a wide variety of package types, such as pallets, cartons, cases, bins and totes. These items can be trade items and/or logistic units.

Barcode scanning may be carried out manually or automatically and the recommended barcode location cannot be optimised for one or the other in an open supply chain scenario. These guidelines have been prepared with the objective to reduce overall supply chain cost but in the full knowledge that implementation will only be driven by a proven (supply chain) business-case.

6.7.1 General rule

The barcodes on units intended for general distribution SHALL be upright (i.e. in picket fence orientation) and placed on the sides of the unit. Each item SHALL have at least one barcode and two are recommended when these barcodes are pre-printed (see section 6.7.3).

As not all products are packed in an identical way, this general rule may not apply to unusual packaging types (e.g., low height items, display cases, bags).

The barcodes SHALL be kept away from any vertical edges so that the barcodes are less likely to be accidentally damaged in transit.

6.7.1.1 Barcode placement on pallets

For all types of pallets, including full pallets containing individual trade items and single trade items, (such as a refrigerator or washing machine), all GS1 barcodes SHALL be positioned in a space between 400 millimetres (16 inches) and 800 millimetres (32 inches) from the base of the pallet. For pallets less than 400 millimetres (16 inches) high, all barcodes SHALL be placed as high as possible.

The barcode(s) including Quiet Zones, SHALL be at least 50 millimetres (2.0 inches) from any vertical edge to avoid damage.

Figure 6.7.1.1-1. Barcode placement on pallets

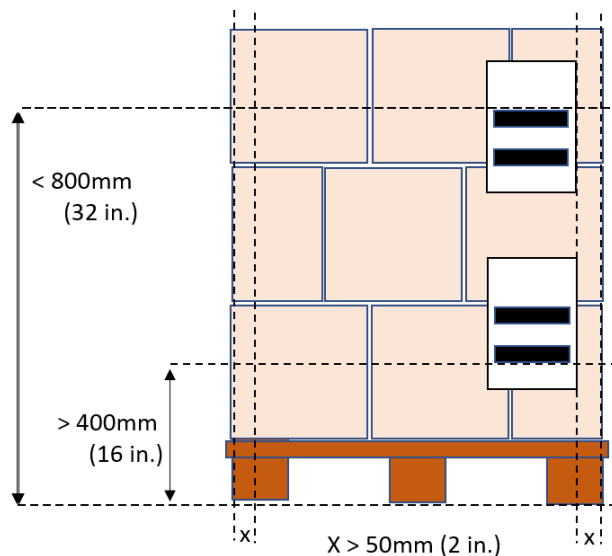
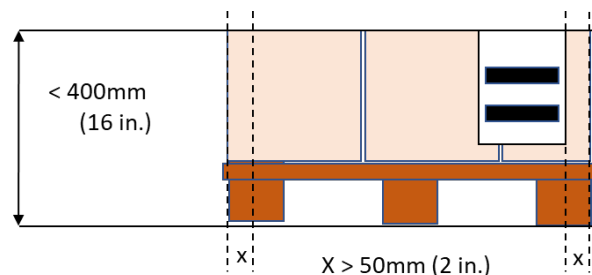

Figure 6.7.1.1-2. Barcode placement on pallets lower than 400 mm (16 inches)



6.7.1.2 Barcode placement on cartons and outer cases

For cartons and outer cases, barcode placement will vary slightly in practice, however the target placement for the bottom of the barcode is 32 millimetres (1.25 inches) from the natural base of the item. The barcode, including its Quiet Zones, SHOULD be at least 19 millimetres (0.75 inch) from any vertical edge to avoid damage.

Figure 6.7.1.2-1. Barcode placement on cartons and outer cases

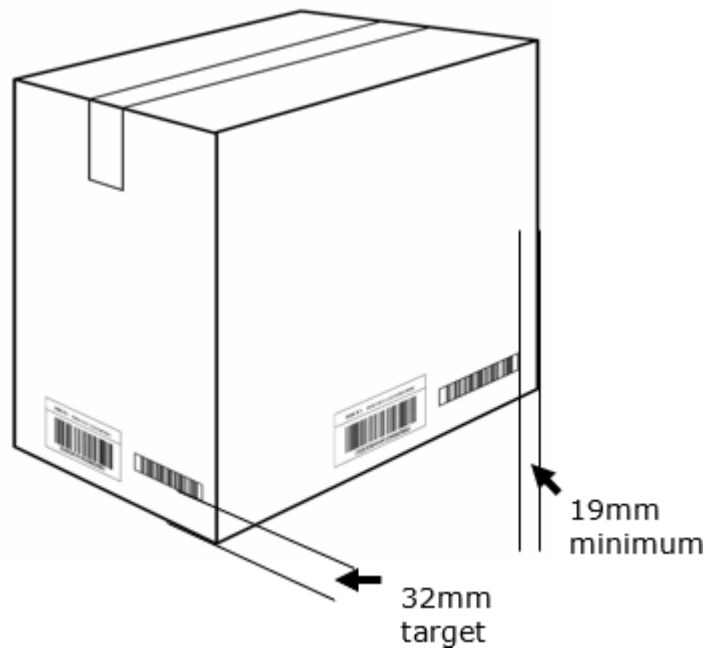

6.7.1.3 Barcode location on shallow trays and cases

If the height of a case or tray is less than 50 millimetres (2.0 inches), making it impossible to print a full height barcode with the human readable interpretation below the bars (see section 4.14 for HRI rules), or if the construction of the unit is such that the full barcode height cannot be accommodated, the following options SHALL be considered in this order of preference:

- Place the human readable interpretation adjacent to the barcode, outside the compulsory Quiet Zones.

Figure 6.7.1.3-1. Human readable interpretation to left of barcode

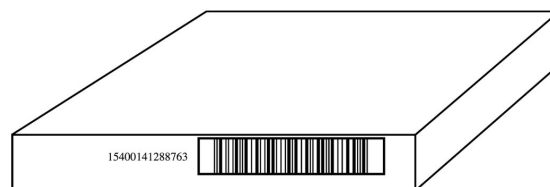

- When the height of the unit is less than 32 millimetres, the barcode may be placed on the top of the package. The barcode SHALL be placed with the bars perpendicular to the shortest side, no closer than 19 millimetres (0.75 inch) from any edge.

Figure 6.7.1.3-2.



Sometimes two barcodes are used on variable measure units. If it is necessary to remove the human readable interpretation from beneath the unit, the human readable interpretation of the main barcodes SHALL be placed to the left of the bars of the main barcode. The human readable interpretation of the supplemental barcode SHALL be placed to the right of the bars of the supplemental barcode.

6.7.2 Recommendation to include a barcode on two sides

At least one side of all general distribution scanning items SHALL display the barcode information. The following is recommended:

- For outer cases or cartons (trade item groupings identified with a GTIN) it is recommended that the barcode is duplicated on a second side of the item when the printing process (e.g., pre-printing on corrugated cartons) makes this cost effective.
- For pallets (logistic units identified with an SSCC) it is recommended that two identical logistic labels are placed on adjacent sides. If possible one logistic label SHOULD be on one short side and the second identical logistic label on the adjacent right-hand side as shown in the diagram below.

Figure 6.7.2-1. Two identical barcodes

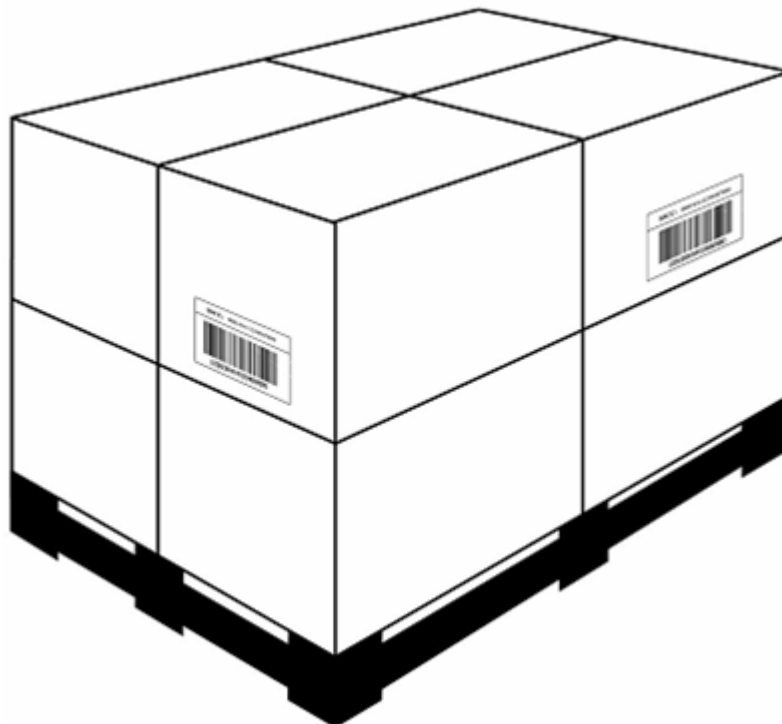

6.7.3 Supplemental barcodes

If the unit is already marked with a barcode, any supplemental barcode SHALL be placed so as not to obscure the main barcode. The preferred location for the barcode in this case is to the side of the main barcode so that a consistent horizontal location is maintained. Maintain Quiet Zones for both barcodes.

Figure 6.7.3-1. Placement of add-on barcodes

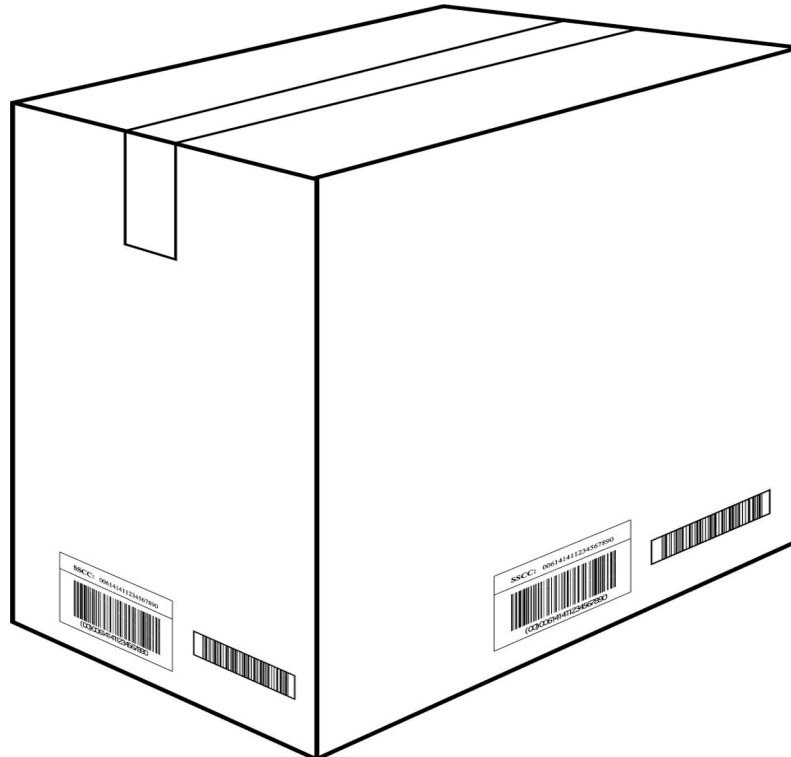

When it is possible for both parts of the data content to be represented in a GS1-128 barcode, concatenation into one barcode MUST be considered. Barcodes for general distribution scanning containing data essential for complete product identification (e.g., trade measurements) SHALL always be aligned with and to the right of the other barcode.

6.8 Barcode placement for regulated healthcare trade items

In addition to the general rules in section 6, the following barcode placement rules SHALL be added for regulated healthcare products.

6.8.1 Blister cells

Blister cells are pre-formed clear plastic bubbles, or blisters, containing a product.

6.8.1.1 Perforated blister cells

- Placement:
 - At the primary packaging level for pharmaceutical products packaged with perforated blister cells, a barcode SHALL be placed on each blister cell.

6.8.1.2 Non-perforated blister cells

- Placement:

- At the primary packaging level for pharmaceutical products packaged with non-perforated blister cells, a barcode SHALL be placed once on the grouping of blister cells (e.g., blister card). The barcode may be placed anywhere on the blister card.
- If random printing (e.g., no one to one correlation between printing impression and blister cell position) is used, the barcode may be placed multiple times to ensure that the barcode remains scannable until each blister has been used.

6.8.2 Products requiring variable data on primary and secondary packaging

Where such marking is feasible from a production and marking standpoint, the barcode carrying variable data (e.g., batch/lot number or expiry date) SHALL be marked on the primary and secondary packaging.

- Placement:
 - The barcode SHALL be placed only on one side of the packaging, which may be either the face, side or end panel.

6.9 Barcode placement for non-new trade items

A non-new trade item may have a permanently affixed identifier, it may not have its original packaging, or the original packaging may not include the necessary identification. Figure 6.6.-1 details the actions to take depending on the state of the non-new trade item when it is offered for sale. For details on identifying non-new trade items see section [2.1.15](#).

Figure 6.6-1 Identify and placement for non-new trade items

State of non-new trade item	Identifier and placement*
Serialised GTIN encoded in a barcode permanently affixed to the non-new trade item	Use original barcode
Serialised identity encoded in an RFID tag permanently affixed to the non-new trade item	Use original RFID tag
Original packaging with GTIN change required	Use original packaging, assign a new GTIN, and obscure original GTIN barcode by label with a new barcode according to the barcode specifications used for the original GTIN.
New packaging when allocating a new GTIN but original GTIN is known	On new packaging include a new barcode with the new GTIN and follow appropriate barcode placement rules for the package type (section 6.4)
No packaging and original GTIN is known	Affix new barcode with GTIN allocated by GTIN allocator and follow barcode placement rules in section 6.
No packaging, no GTIN of original brand owner available, GTIN required	Affix new barcode with the third-party allocated GTIN encoded in a barcode appropriate to the application scope (e.g., for retail point-of-sale).
* Ensure that the barcode intended for scanning will be scanned by obscuring all barcodes that are being replaced. Section 6 contains complete information on barcode placement criteria to meet quality and ergonomic needs.	

7 AIDC validation rules

7.1 Introduction

The purpose of entering data transmitted from a reading device into a system is to record a transaction. In the GS1 system, a transaction is an Electronic Message to be processed according to the meaning and content of the data fields contained in the message. This should be possible without requiring any human intervention to determine the data's meaning and content.

First, an item must be physically present in order to produce a barcode or RFID reader message about the item. Only the data present in the data carrier on the item, and therefore relevant to it, can be recorded.

The standardised element strings of the GS1 system are the basis for the identification of items of every kind. They identify a particular item in an unambiguous manner and supply relevant attribute information.

When these element strings are printed on items, the scanned and transmitted data refers to that item and identifies its physical presence at a given location. When the message read from the scanned data carrier is coupled with an internally assigned designation of the type of item movement (e.g., warehouse entry, stock taking, sales), it is possible to automatically record data related to each movement of items. This provides security in two ways. First, an item must be physically present in order to produce a barcode reader message about the item, and second, only the data in the barcode on the item and, therefore, relevant to it, can be recorded. False notification of movements is thereby largely eliminated.

When element strings are used in administrative areas (e.g., in order entry) they also can be used for automatic, error-free data capture. Because of the considerable length of many GS1 system ID numbers, automatic reading has great significance. By using a check digit, a digit that ensures the data has been correctly composed, the accuracy of the reading is verified.

7.2 Synopsis of message processing

Figure 7.2-1. Synopsis of element string message processing

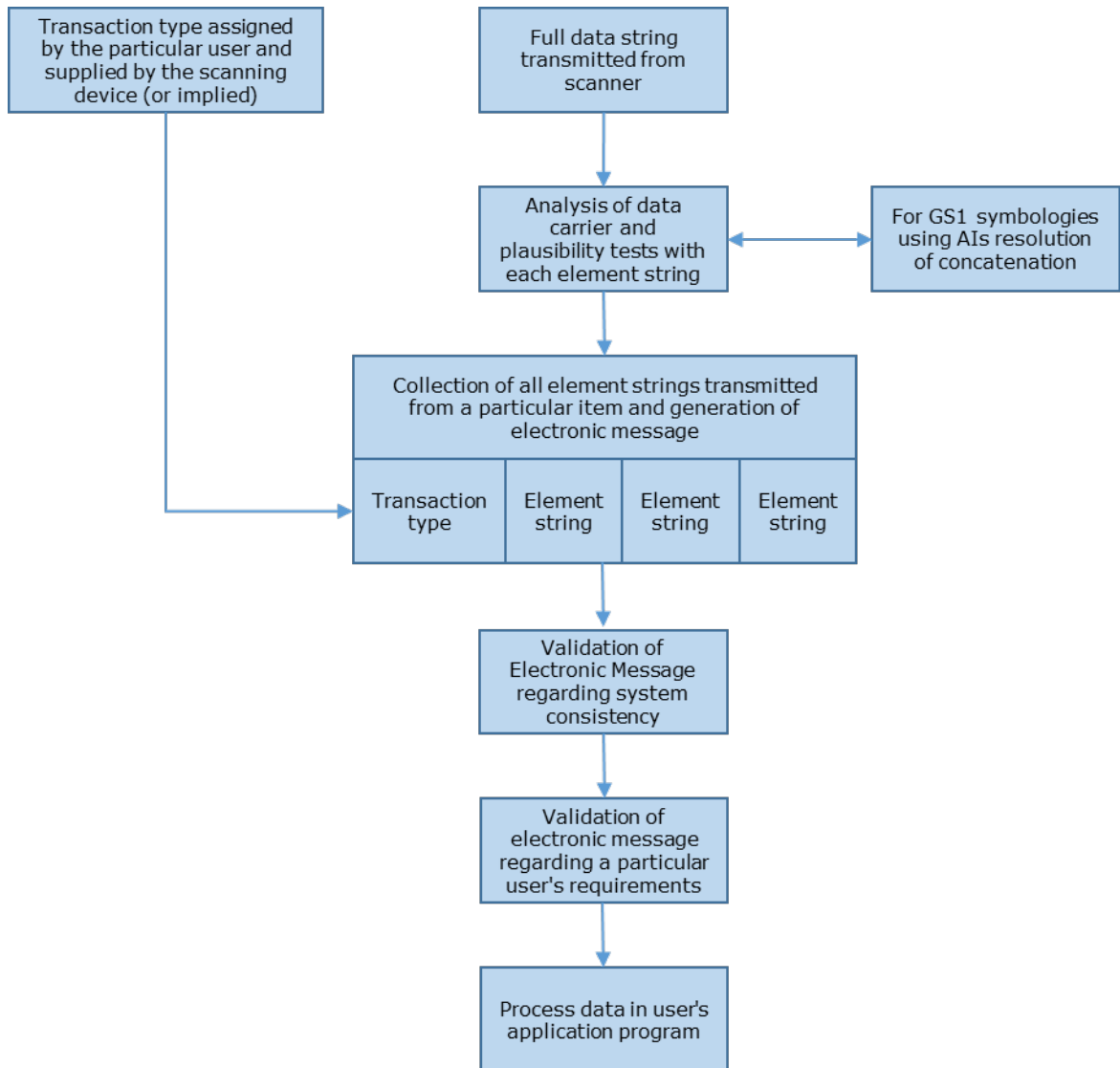

For details on any of the actions in figure [7.2-1](#), see the following subsections.

Note: For message processing using the GS1 Digital Link URI syntax see the [GS1 Digital Link standard](#) for detailed information

7.2.1 Analysis of the data carrier and plausibility test for element strings

Figure 7.2.1-1. Test procedure

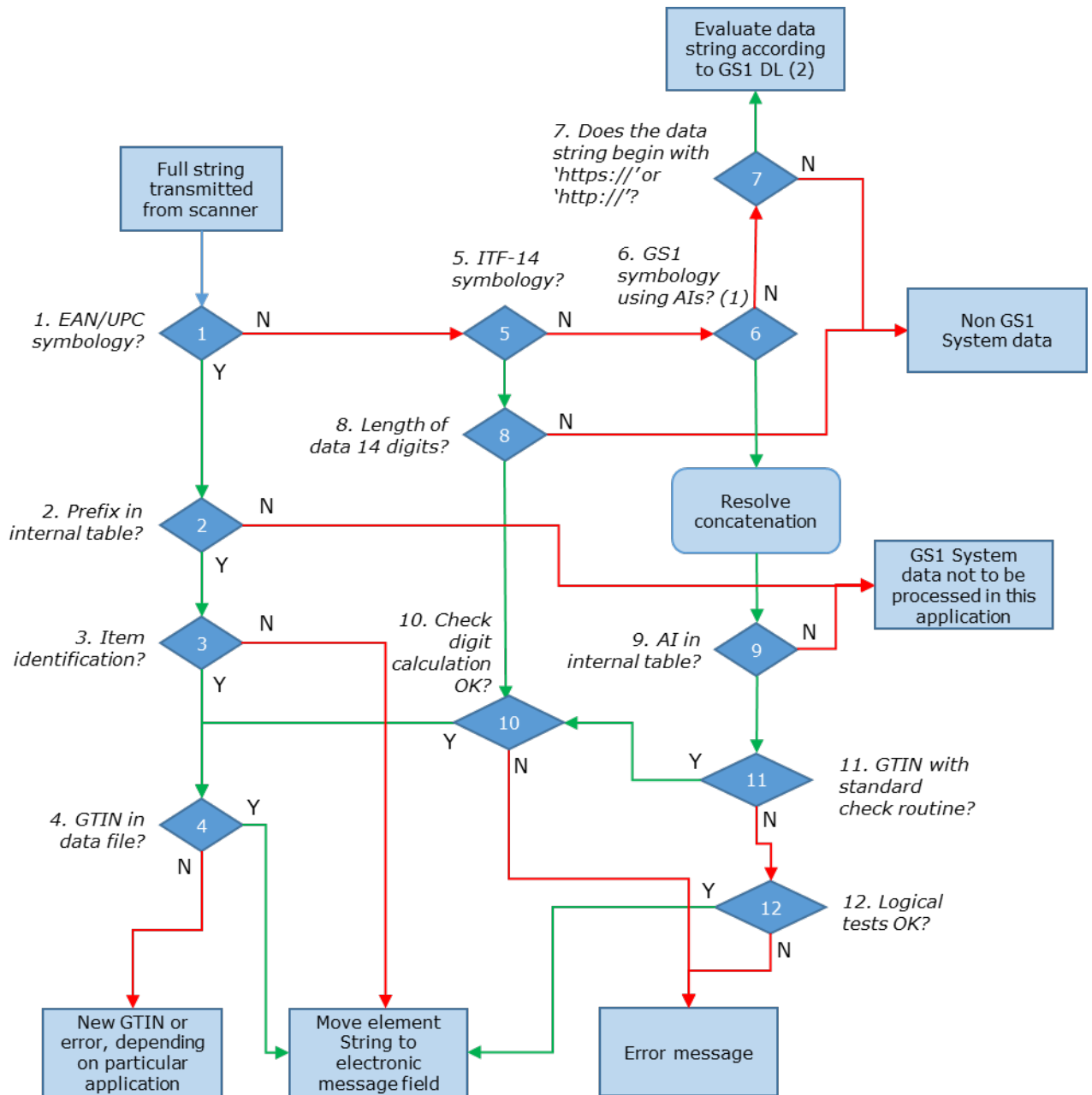

- (1) GS1 symbologies that encode data using GS1 Application Identifiers include GS1-128, GS1 DataMatrix, GS1 QR Code, GS1 DotCode, GS1 DataBar and Composite and are shown in 7.8. For further details on any of the actions in figure 7.2.1-1, see the sections 7.2.2, 7.2.3, 7.2.4, 7.2.5, 7.2.6, 7.2.7 and 7.2.8.
- (2) For QR Code and Data Matrix symbologies encoding the GS1 Digital Link URI syntax see the [GS1 Digital Link standard](#) for detailed information

7.2.2 Symbology identification

Each transmitted full string consists of a symbology identifier and one or more element strings (see section 3). The identifiers of barcode symbologies are stated in section 5.

7.2.3 Prefix in internal table

System users may generate an internal table showing the GS1 Prefixes of element strings they wish to process. This table also serves to sort out the element strings representing item identification numbers in order to check their presence in the data file. Details on the respective prefixes are stated in section [3](#).

7.2.4 Item Identification

The symbols in the EAN/UPC symbology family contain identification data for trade items and special data structures (e.g., coupons). Whether an element string contains the identification of a trade item is determined by the GS1 Prefix. System users must determine the specific structure and meaning of prefixes 20 to 29 as defined by their GS1 Member Organisation.

7.2.5 GS1 Application Identifier (AI) in internal table

The element strings using GS1 Application Identifiers cover a wide range of applications. In order to keep the amount of programming on a reasonable level, it is possible to ignore processing of unwanted element strings. This is achieved by establishing an internal table with only the GS1 Application Identifiers intended for processing.

7.2.6 Length of data 14 Digits

ITF-14 barcodes are used to represent trade item identification numbers. As the use of the general ITF symbology is not exclusive to the GS1 system a check to ensure the symbol encodes 14-digit reference field is recommended.

7.2.7 Check digit calculation and other system checks

In EAN/UPC symbology, the check digit verifies reading and decoding of barcodes as well as Global Trade Item Numbers (GTINs). This is performed automatically by the barcode reader.

Barcode readers processing ITF-14 symbols may be programmed to verify the GTIN's check digit as well. If this recommended verification has been performed, it is indicated by the symbology identifier **J11** (see section [5](#)). For data transmitted from ITF-14 symbols with symbology identifier **J10**, the GTIN's check digit SHALL be verified separately.

GS1-128 and GS1 DataBar have an integral symbol check character that verifies correct decoding of scanned data while GS1 DataMatrix, GS1 QR Code and GS1 DotCode have a Reed Solomon error checking and correction feature. If an element string encoded in one of these symbol types includes a check digit, the check digit will not normally be verified by the barcode reader and SHALL be verified separately. While the data security provided by the symbol check character or error checking guarantees proper decoding of the entire element string, correctness of the contained identification number is achieved by having the application software verify the ID number's check digit. Other logical tests checks are recommended for reasonable data content, such as verifying:

- Data field ranges (e.g., month < 13 and > 00).
- The maximum length of a variable length element string.
- No alphanumeric characters in numeric only fields.
- Correct GS1 Prefixes.

7.2.8 Move element string to message field

Several element strings may be scanned in a single transaction. In order to verify the correctness and completeness of the transmitted data, each element string is transferred to a message record. If an element string does not include a GS1 Application Identifier, verification of the message is simplified if a GS1 Application Identifier is internally assigned. Global Trade Item Numbers (GTINs) that are carried by EAN-13, UPC-A, UPC-E or ITF-14 barcodes may be denoted with an internally assigned AI (01). Other element strings may be assigned "ghost" GS1 Application Identifiers.

7.3 Validation of the electronic message regarding system consistency

The GS1 system enables system users to process scanned data without human intervention. This implies that the electronic message generated from data scanned and transmitted from data carriers needs to substitute for all human activities during a particular transaction. In other words, the transmitted data must provide all information required for its correct processing.

The GS1 system is designed to fulfil these requirements. Section 4 describes the association of element strings to form valid messages.

Validation of system consistency refers to the verification of the correct composition of the electronic message by a system processing the transaction messages. Whether the message is adequate in business application terms is dealt with by the application software.

Only messages containing a valid set of element strings defined in the GS1 system can be unambiguously processed. The processing of invalid messages may lead to data file errors because the meaning and relationship of the element strings are not defined. This is illustrated in figures 7.3-1 and 7.3-2.

Figure 7.3-1. Examples of valid messages

Element strings in message			Comment
AI 00	AI 33nn		Identification of a logistic unit + logistic weight
AI 00	AI 01		Identification of an entity as a logistic unit and as a fixed measure trade item
AI 00	AI 01 with N1 = '9'	AI 31nn	Identification of an entity as a logistic unit and as a variable measure trade item
AI 00	AI 02	AI 37	Identification of a logistic unit and its contained fixed measure trade items
AI 01	AI 10	AI 15	Identification of a trade item + lot number + best before date
AI 00	AI 401		Identification of a logistic unit as part of a consignment
AI 01 '9'	AI 31nn	AI 33nn	Identification of a variable measure trade item + logistic weight
AI 00	AI 01	AI 33nn	Identification of an entity as a logistic unit and a fixed measure trade item; the logistic weight is associated with the identification number of the logistic unit
AI 01	AI 710		Identification of a trade item + National Healthcare Reimbursement Number
AI 01	AI 711		Identification of a trade item + National Healthcare Reimbursement Number
AI 01	AI 712		Identification of a trade item + National Healthcare Reimbursement Number
AI 01	AI 713		Identification of a trade item + National Healthcare Reimbursement Number
AI 01	AI 714		Identification of a trade item + National Healthcare Reimbursement Number
AI 01	AI 715		Identification of a trade item + National Healthcare Reimbursement Number
AI 01	AI 716		Identification of a trade item + National Healthcare Reimbursement Number

Figure 7.3-2. Examples of invalid messages

Element strings in message			Comment
AI 00	AI 01	AI 37	Invalid identification of an entity as a logistic unit and as a fixed measure trade item; AI 37 (quantity of items contained) must be used with AI 02 only
AI 01	AI 10	AI 33nn	Invalid identification of a fixed measure trade item + lot number; AI 33nn is incorrect because logistic measures of a fixed measure trade item are fixed attributes stored in the data file
AI 01 '9'	AI 33nn		Invalid identification of a variable measure trade item + logistic weight; the mandatory element string with a trade measure is missing
AI 00	AI 11		Invalid identification of a logistic unit; AI 11 is incorrect because a production date must be associated with the identification number of a trade item
AI 00	AI 01	AI 02/37	Invalid identification of an entity as a logistic unit and as a fixed measure trade item; AI 02/37 must not be associated with AI 01
AI 01	AI 30		Invalid identification of a fixed measure trade item; AI 30 must only be associated with the identification number of a variable measure trade item
AI 02	AI 37		Invalid identification of the fixed measure trade units contained in an unidentified logistic unit; AI 00 is missing

Element strings in message			Comment
AI 00	AI 02		Invalid identification of a logistic unit and of the contained fixed measure trade items; AI 02 requires the mandatory presence of AI 37 to complete the identification of the content

7.4 Validation of the electronic message regarding user requirements

Some industry groups and organisations specify the use of particular element strings for attributes and other information not directly identifying the item. Contrary to the validation of messages for system conformity, GS1 does not define the rules for the validation and application of these particular element strings. Validation of messages containing these element strings in these environments (e.g., trade item identification with best before date and batch number) is left to the discretion of the particular system user community.

Validation of the correctness of a message may be performed differently for each Global Trade Item Number (GTIN) and instructions must be stored in the data file. System users should include the GS1 Application Identifiers and their specific application rules in the stored instructions.

Validation of the user requirements must be performed after validation of system consistency. Missing elements in consistent messages may be by-passed or completed in given instances. Inconsistent messages can never be processed properly.

7.5 Conversion of weights and measures in user applications

All weights and measures that are encoded in the element strings with the GS1 Application Identifiers (31nn) to (36nn) are structured according to the same mathematical rules. The determination of basic units of measurement and the freedom to choose the number of decimal positions will lead to variations in data representation. Suppliers will choose the value that best suits the respective trade item in terms of weight/size and the degree of accuracy required (e.g., grams) for the representation of weights and measures in the six-position data field.

The recipient of such goods also may want to store these details in a standardised form in his data file. This requirement is easily fulfilled through programming with the conversion formula shown below.

As described in section 3, in the GS1 Application Identifier position A₄ denotes the position of the implied decimal point, called the inverse exponent. The three-step formula to convert weights and measures is as follows:

1. Define the company's internal inverse exponent in accordance with the basic unit of measure of the company's internal field structure (e.g., for an AI expressing weight in kilograms, inverse exponent 0 could signify kilograms and inverse exponent 3 could signify grams).
2. Subtract the company's internal inverse exponent from the value of the position A₄ of the GS1 Application Identifier in the decoded element string. Call the result X.
3. Divide the amount of the six-digit applicable value field from the decoded data string by 10^X. The result is the value required in the company's data structure.

In the examples in figure 7.5-1, the company's system uses internal weight fields eight digits in length (format: **nnnnnnn.n**) with a unit of measure equal to grams. Thus, the company uses the internal inverse exponent of 3.

Figure 7.5-1. Conversion examples

Decoded data string				Weight	Conversion	Internal weight field										
GS1 Application Identifier	A ₁	A ₂	A ₃ A ₄			Eight-digit data field defined as grams with one decimal position										
3	1	0	0	005097 (= 5097 kg)	Step 2: X = 0 minus 3 = -3 Step 3: 005097 divided by 10 ⁻³ (.001) =	5	0	9	7	0	0	0				
3	1	0	2	005097 (= 50.97 kg)	Step 2: X = 2 minus 3 = -1 Step 3: 005097 divided by 10 ⁻¹ (.1) =	0	0	5	0	9	7	0				

Decoded data string				Conversion	Internal weight field								
3	1	0	3	045250 (= 45.250 kg)	Step 2: $X = 3 \text{ minus } 3 = 0$ Step 3: 045250 divided by $10^0 (1) =$	0	0	4	5	2	5	0	
3	1	0	4	012347 (= 1234.7 g)	Step 2: $X = 4 \text{ minus } 3 = 1$ Step 3: 012347 divided by $10^1 (10) =$	0	0	0	1	2	3	4	7

↑
Decimal point

In the examples in figure 7.5-2, the company’s system uses internal weight fields eight digits in length (format: **nnnnn.nnn**) with a unit of measure equal to kilograms. Thus the company uses an internal inverse exponent of 0

Figure 7.5-2. Conversion examples

Decoded data string				Conversion	Internal weight field								
GS1 Application Identifier <i>A1 A2 A3 A4</i>				Weight		Eight-digit data field defined as kilograms with three decimal position							
3	1	0	0	005097 (= 5097 kg)	Step 2: $X = 0 \text{ minus } 0 = 0$ Step 3: 005097 divided by $10^0 (1) =$	0	5	0	9	7			
3	1	0	2	005097 (= 50.97 kg)	Step 2: $X = 2 \text{ minus } 0 = 2$ Step 3: 005097 divided by $10^2 (100) =$	0	0	0	5	0	9	7	
3	1	0	3	045250 (= 45.250 kg)	Step 2: $X = 3 \text{ minus } 0 = 3$ Step 3: 045250 divided by $10^3 (1000) =$	0	0	0	4	5	2	5	
3	1	0	4	012347 (= 1234.7 g)	Step 2: $X = 4 \text{ minus } 0 = 4$ Step 3: 012347 divided by $10^4 (10000) =$	0	0	0	0	1	2	3	5

↑ ↑
Decimal point Position rounded

7.6 Linkage of GTINs in a database

A trade item is any item (product or service) upon which there is a need to retrieve predefined information and that may be priced, or ordered, or invoiced at any point in any supply chain. Trade items may be a single item, part, unit, product, or service, or a predefined multiple or grouping or combination of such items. A separate Global Trade Item Number (GTIN) identifies each of these items unambiguously, irrespective of the applied data structure. This also applies to identification numbers for restricted distribution in a closed environment.

Information about the hierarchical structure of trade items is an important issue in a business. Section 7.6.1 illustrates an example of how the required links can be established by using a relational database.

7.6.1 The principle

The hierarchy for the example in figure 7.6.1-1 is basic product = A; $10 \times A =$ product B; $5 \times B =$ product C.

Figure 7.6.1-1. Example of GTIN linkage in database

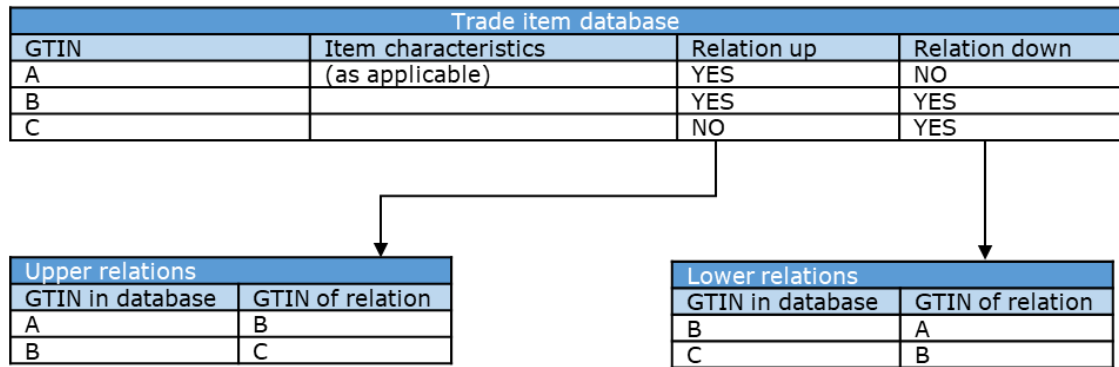

See figure [7.6.2-1](#) for the mechanism of linkage for the various types of trade items.

7.6.2 Extended example of a trade item hierarchy

Figure 7.6.2-1. Extended example of trade item hierarchy

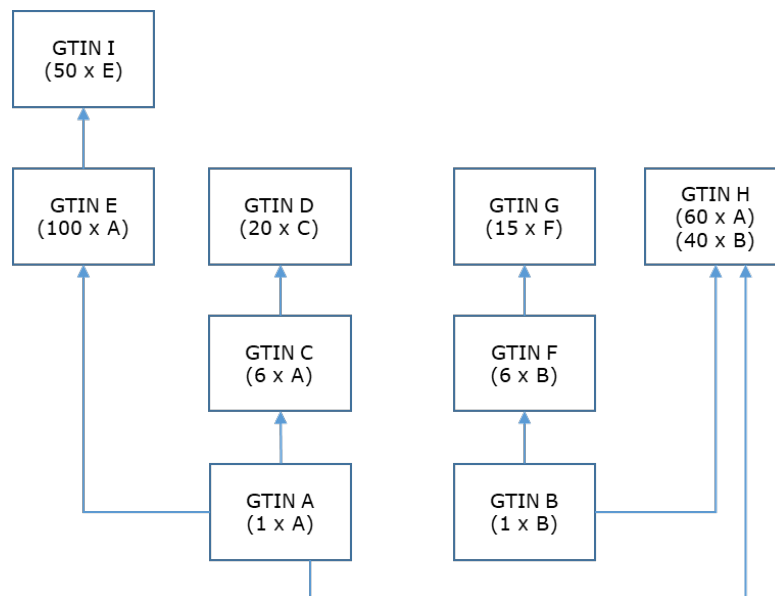

Note: For reasons of simplicity, Global Trade Item Numbers (GTINs) are expressed in letters in this example, signifying that they may be of any standardised structure.

Figure 7.6.2-2. Example of GTIN linkage in database

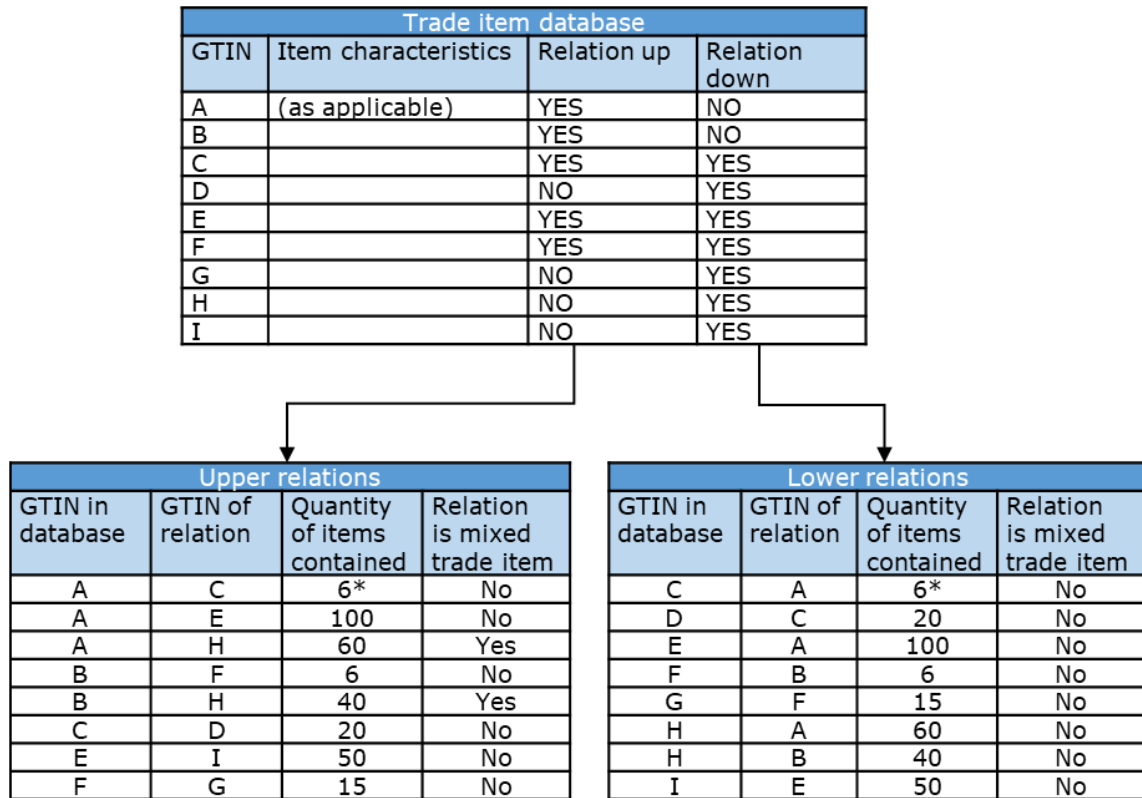

* Quantity of items numbered A contained in item C

 **Note:** The columns "GTIN in database" and "GTIN of relation" are sufficient to establish the links between the different items. The column "Quantity of items contained" provides additional information, which may be useful in particular business applications. The column "Relation is mixed trade item" provides the relations pointing to all trade items contained in a mixed trade item.

7.6.3 Linkage of GTINs in a non-relational database by trade item manufacturer

Many types of items are produced and distributed in fixed measure nested packaging configurations (e.g., consumer unit, carton, case, pallet) with fixed quantity relationships. The various packaging configurations are often broken into lower levels at various points in the supply chain and, therefore, each level of the packaging may be a trade item. Computer systems must be capable of understanding the relationships of the units or trade items in the configuration and treating inventory of all levels of the configuration as one SKU (stock keeping unit).

The first digit indicator (values 1 to 8) of the GTIN-14 data structure can be used to identify levels of a packaging configuration. This allows digits 2 to 13 to remain constant for all levels of the packaging configurations for an item. If this method of numbering item configurations is used when necessary to support business processes or when driven by system constraints, the non-relational database construct defined below may be appropriate.

The item database is constructed with a base item record (table) and segments (tables) for each level of the item packaging configuration. Properly designed, this type of system can support pricing, ordering and shipping of any level of the packaging configuration (trade item) with appropriate dimension and weight information. It enables inventories to be maintained by packaging level and in total for the base item. It also provides channel partners or customers the choice of ordering and invoicing units. Meeting these requirements often makes this approach a good business solution for manufacturers, because it meets the most critical needs in the supply chain

and is practical to implement, particularly in distributed and small systems where performance is critical.

Using the GTIN-14 data structure, the base item record contains the base GTIN-8, GTIN-12, or GTIN-13 ID Number (digits 2 to 13) as a key, with all information relating to the base unit and the item in total (including total inventory balance). Each of the packaging segments contains information unique to the respective packaging configuration (e.g., indicator, check digit, quantity relationship to next lower level of the configuration, dimensions, weight, prices). After accessing the item record using the GTIN of the base item (digits 2 to 13), the packaging segments are accessed using the indicator (first digit). This construct demands that:

- The trade item must be fixed in measure.
- There must be a single Global Trade Item Number (GTIN) for the base item of the related packaging configurations that is a GTIN-8, GTIN-12, or GTIN-13.
- Each related packaging configuration is limited to eight levels of packaging for the base item using indicator values 1 to 8.

When storing GTIN-8s, GTIN-12s, or GTIN-13s in a 14-digit reference field or 14-digit data carrier, they must be stored based on rules that ensure their uniqueness.

Companies that receive trade items with GTINs must be able to process the complete GTIN without regard to how it was constructed.

7.7 Element strings represented in data carriers

Scanned element strings are decoded as a full string by the reading device and are then transmitted for processing in the application software. The full string is composed of a symbology identifier and one or more element strings. The meaning of an element string is also determined by the data carrier in which it is represented.

A synopsis by data carrier of the element strings described in these specifications is shown in figure [7.7-1](#), which also provides an overview of the sequential number range of trade items by data carrier.

The element strings encoded in any GS1 symbology that uses GS1 Application Identifiers (such as GS1-128, GS1 DataMatrix, GS1 DataBar, GS1 QR Code, GS1 DotCode and GS1 Composite) are composed of one or more GS1 Application Identifiers and one or several data fields. The GS1 Application Identifier denotes the contents and structure of the respective data fields, see section [3](#). Section [7.8](#) provides more information on the data processing aspects.

Figure 7.7-1. Element strings by data carrier

		ITF-14 or GS1-128 barcode															
		EAN-13 barcode															
		UPC-A or UPC-E barcode															
								EAN-8 barcode									
2.	*	*	*	*	*	*	*	0	0	0	0	0	0	0	0	0	C
								0	9	9	9	9	9	9	9	9	C
1.	*	*	*	*	*	*	*	1	0	0	0	0	0	0	0	0	C
								1	3	9	9	9	9	9	9	9	C
2.	*	*	*	*	*	*	*	2	0	0	0	0	0	0	0	0	C
								2	9	9	9	9	9	9	9	9	C
1.	*	*	*	*	*	*	*	3	0	0	0	0	0	0	0	0	C
								9	6	9	9	9	9	9	9	9	C
1.	0	0	0	0	0	1	0	0	0	0	0	0	0	0	0	0	C
	0	0	0	0	0	9	9	9	9	9	9	9	9	9	9	9	C
2.	*	*	0	0	1	0	0	0	0	0	0	0	0	0	0	0	C
			0	0	7	9	9	9	9	9	9	9	9	9	9	9	C
1.	0	0	0	0	8	0	0	0	0	0	0	0	0	0	0	0	C
	0	0	1	9	9	9	9	9	9	9	9	9	9	9	9	9	C
4.	*	0	2	0	0	0	0	0	0	0	0	0	0	0	0	0	C
		0	2	9	9	9	9	9	9	9	9	9	9	9	9	9	C
1.	0	0	3	0	0	0	0	0	0	0	0	0	0	0	0	0	C
	0	0	3	9	9	9	9	9	9	9	9	9	9	9	9	9	C
2.	*	0	4	0	0	0	0	0	0	0	0	0	0	0	0	0	C
		0	4	9	9	9	9	9	9	9	9	9	9	9	9	9	C
5.	*	0	5	0	0	0	0	0	0	0	0	0	0	0	0	0	C
		0	5	9	9	9	9	9	9	9	9	9	9	9	9	9	C
1.	0	0	6	0	0	0	0	0	0	0	0	0	0	0	0	0	C
	0	0	9	9	9	9	9	9	9	9	9	9	9	9	9	9	C
1.	0	1	0	0	0	0	0	0	0	0	0	0	0	0	0	0	C
	0	1	3	9	9	9	9	9	9	9	9	9	9	9	9	9	C
2. 4.	*	2	0	0	0	0	0	0	0	0	0	0	0	0	0	0	C
	*	2	9	9	9	9	9	9	9	9	9	9	9	9	9	9	C
1.	0	3	0	0	0	0	0	0	0	0	0	0	0	0	0	0	C
	0	9	6	9	9	9	9	9	9	9	9	9	9	9	9	9	C
7.	*	9	7	7	0	0	0	0	0	0	0	0	0	0	0	0	C
		9	7	9	9	9	9	9	9	9	9	9	9	9	9	9	C
8.	*	9	7	8	0	0	0	0	0	0	0	0	0	0	0	0	C
	*	9	7	9	9	9	9	9	9	9	9	9	9	9	9	9	C
5. 6.	*	9	8	0	0	0	0	0	0	0	0	0	0	0	0	0	C
		9	8	2	9	9	9	9	9	9	9	9	9	9	9	9	C
5.	*	9	9	0	0	0	0	0	0	0	0	0	0	0	0	0	C
		9	9	9	9	9	9	9	9	9	9	9	9	9	9	9	C
1.	1	0	0	0	0	0	0	1	0	0	0	0	0	0	0	0	C
	8	0	0	0	0	0	0	1	3	9	9	9	9	9	9	9	C
1.	1	0	0	0	0	0	0	3	0	0	0	0	0	0	0	0	C
	8	0	0	0	0	0	0	9	6	9	9	9	9	9	9	9	C
1. 3.	1	0	0	0	0	1	0	0	0	0	0	0	0	0	0	0	C
	9	0	0	0	0	9	9	9	9	9	9	9	9	9	9	9	C
1. 3.	1	0	0	0	9	0	0	0	0	0	0	0	0	0	0	0	C
	9	0	1	9	9	9	9	9	9	9	9	9	9	9	9	9	C
1. 3.	1	0	3	0	0	0	0	0	0	0	0	0	0	0	0	0	C
	9	0	3	9	9	9	9	9	9	9	9	9	9	9	9	9	C
1. 3.	1	0	6	0	0	0	0	0	0	0	0	0	0	0	0	0	C
	9	0	9	9	9	9	9	9	9	9	9	9	9	9	9	9	C
1. 3.	1	1	0	0	0	0	0	0	0	0	0	0	0	0	0	0	C
	9	1	3	9	9	9	9	9	9	9	9	9	9	9	9	9	C
1. 3.	1	3	0	0	0	0	0	0	0	0	0	0	0	0	0	0	C
	9	9	6	9	9	9	9	9	9	9	9	9	9	9	9	9	C
8.	1	9	7	8	0	0	0	0	0	0	0	0	0	0	0	0	C
	8	9	7	9	9	9	9	9	9	9	9	9	9	9	9	9	C

1. Fixed measure; 2. Fixed measure restricted distribution; 3. Variable measure; 4. Variable measure restricted distribution (not a GTIN); 5. Coupons (not a GTIN); 6. Refund receipts (not a GTIN); 7. ISSN; 8. ISBN

7.8 Processing of data from a GS1 symbology using GS1 Application Identifiers

Figure 7.8-1. Data processing overview

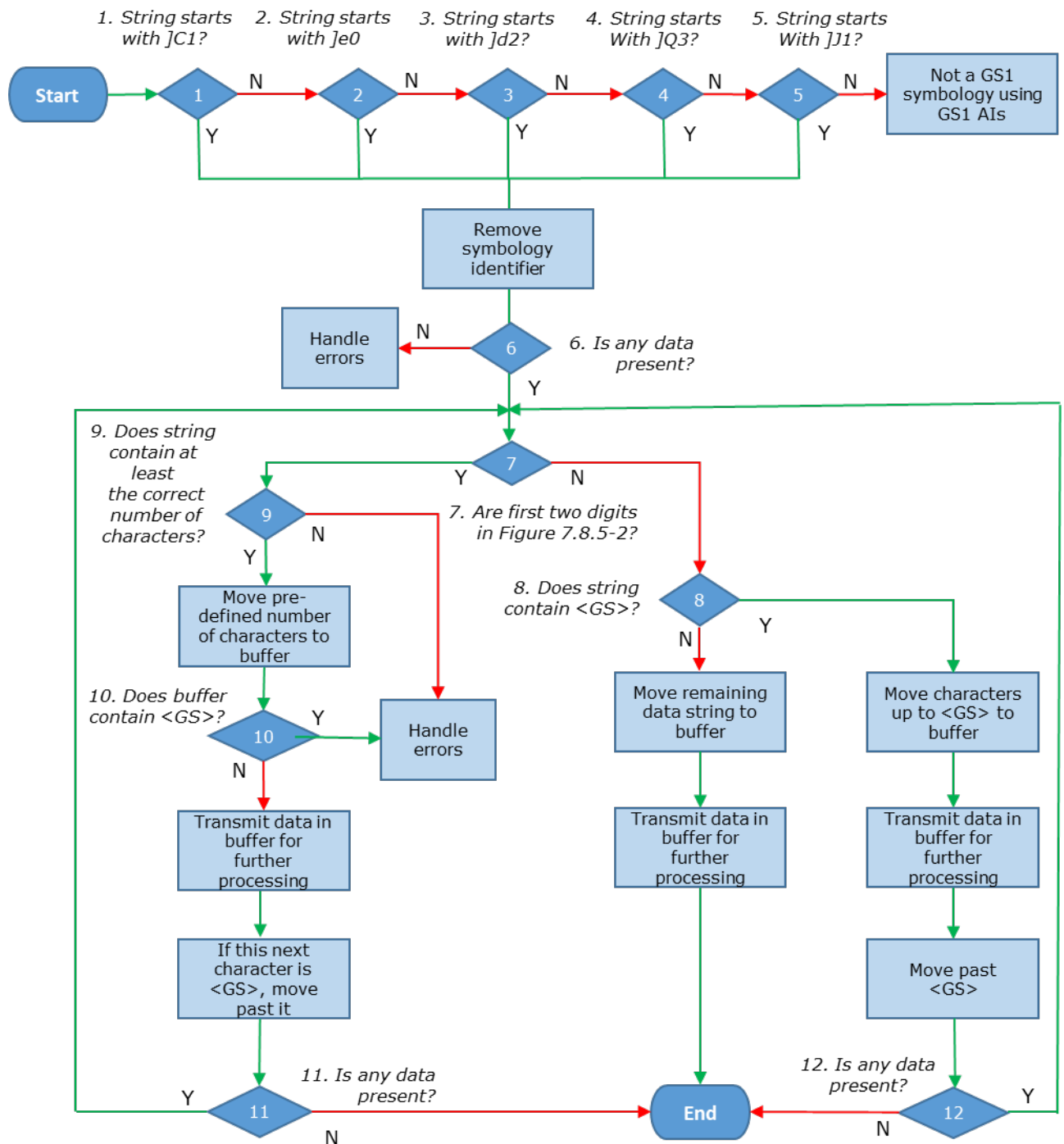

This system logic holds true for any GS1 symbology using GS1 Application Identifiers. The symbology identifiers listed in figure [7.8-1](#) are:

- **]C1** = GS1-128.
- **]e0** = GS1 DataBar and GS1 Composite symbols.
- **]d2** = GS1 DataMatrix.

- **JQ3** = GS1 QR Code.
- **JJ1** = GS1 DotCode.

7.8.1 General

Any GS1 symbology using GS1 Application Identifiers may represent several element strings in concatenated form (see section 5).

For processing as shown in figure 7.3-1, it is necessary to separate each element string, which is performed by the processing routine illustrated in figure 7.8-1.

7.8.2 GS1 Application Identifier lengths

Assigned GS1 Application Identifiers have a defined length. Each GS1 Application Identifier is 2, 3 or 4 digits in length. Knowing these lengths can assist in processing data strings. When a GS1 Application Identifier is approved for application use, the length of the GS1 AI is defined. All GS1 AIs beginning with the same two lead digits SHALL have the same length. Figure 7.8.2-1 provides the defined lengths of GS1 AIs based on the leading two digits.

Figure 7.8.2-1 GS1 Application Identifier lengths

First 2 digits	GS1 AI length	First 2 digits	GS1 AI length	First 2 digits	GS1 AI length	First 2 digits	GS1 AI length	First 2 digits	GS1 AI length
00	2	17	2	33	4	70	4	94	2
01	2	20	2	34	4	71	3	95	2
02	2	21	2	35	4	72	4	96	2
03	2	22	2	36	4	80	4	97	2
10	2	23	3	37	2	81	4	98	2
11	2	24	3	39	4	82	4	99	2
12	2	25	3	40	3	90	2		
13	2	30	2	41	3	91	2		
15	2	31	4	42	3	92	2		
16	2	32	4	43	4	93	2		

7.8.3 Element strings with predefined lengths using GS1 Application Identifiers

Representation of more than one element string in a GS1 symbology using GS1 Application Identifiers may require the use of a separator character between the different element strings to mark their end.

However, in order to enable printing of smaller barcodes, some element strings have been predefined in length, so that their end is determined and a separator character SHOULD NOT be used. These element strings are shown in the predefined table in figure 7.8.5-2. All other element strings, even if defined as fixed length in section 3, are not of predefined length and are formally variable length fields which require a separator character if followed by another element string.

A separator character SHOULD NOT be used at the end of the last element string represented in a barcode or for certain AI combinations defined by the symbology specification (e.g., some types of GS1 DataBar).

7.8.4 The separator character and its value

In GS1-128 symbology: The Function 1 Symbol Character (FNC1) SHOULD be the separator character, and the control character <GS> (ASCII value 29 (decimal), 1D (hexadecimal)) may be an alternative.

In GS1 DataMatrix and GS1 DotCode symbology: The Function 1 Symbol Character (FNC1) or the control character <GS> SHALL be the separator character.

In GS1 QR Code symbology: The control character <GS> or the character '%' (ASCII value 37 (decimal), 25 (hexadecimal)) SHALL be the separator character.

In GS1 DataBar and GS1 Composite symbology: The Function 1 Symbol Character (FNC1) SHALL be the separator character.

The value of the decoded separator character transmitted in the decoded data string is always control character <GS> (ASCII value 29 (decimal), 1D (hexadecimal)). It is important to note that some receiving systems may convert/interpret the control character <GS> as something other than ASCII value 29 (decimal), 1D (hexadecimal).

All element strings not included in the predefined table shown in figure 7.8.5-2 MUST be separated by a separator character when followed by another element string in a single barcode.

7.8.5 The basic structure of GS1 barcodes using GS1 Application Identifiers and concatenation

GS1 barcode symbologies that use GS1 Application Identifiers generally have a particular symbol character to indicate that the data is encoded according to the GS1 Application Identifier rules. For example, the GS1-128 symbology uses the Function 1 Symbol Character (FNC1) in the position immediately following the start character. This character pattern is reserved for GS1 system applications worldwide and makes it possible to distinguish GS1-128 barcodes from Code 128 symbols encoding non-GS1 data.

Figure 7.8.5-1. Example GS1-128 barcode structure

Start character A , B, or C	Function 1 Symbol Character (FNC1)	Element string(s)		Symbol check character	Stop character
		GS1 Application Identifier	Data field		

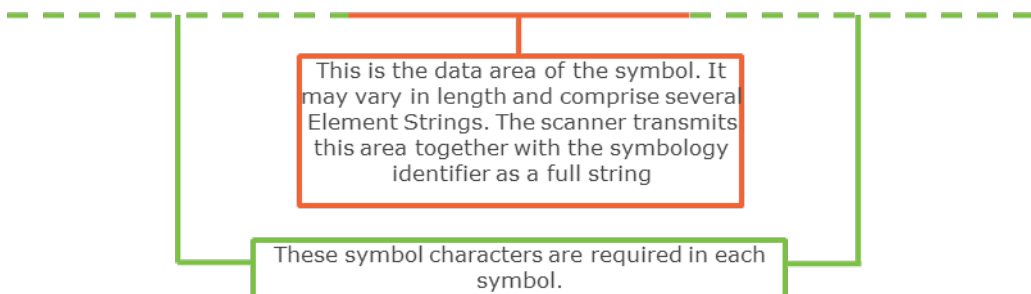

All GS1 barcode symbologies that use GS1 Application Identifiers allow several element strings to be encoded in one barcode, a process called concatenation. Concatenation is advantageous because it means that the symbol's double start, symbol check and stop characters are only needed once and the space required for the symbol is smaller than when separate barcodes are used to encode each element string. It also improves scanning accuracy, allowing for single scanning rather than multiple scanning. The various element strings are transmitted from the barcode reader as a single full string.

The various element strings, which are transmitted from concatenated barcodes, have to be analysed and processed. All element strings need to be separated by a separator character unless they have a predefined length or appear at the end of the symbol (encoded immediately before the symbol check character). All predefined length element strings are contained in figure 7.8.5-2).

The separator character SHALL be either the Function 1 Symbol Character (FNC1), or the control character <GS> (ASCII value 29 (decimal), 1D (hexadecimal)), or, in the case of GS1 QR Code symbology, the control character <GS> or the character '%' (ASCII value 37 (decimal), 25 (hexadecimal)). Figure 7.8.5-2 contains all element strings that have a predefined length and, therefore, SHOULD NOT be terminated by a separator character.

Figure 7.8.5-2. Element strings with predefined length using GS1 Application Identifiers

First two digits of the GS1 Application Identifier	Number of characters (GS1 Application Identifier and data field)
00	20
01	16
02	16
03	16
(04)	18
11	8
12	8
13	8
(14)	8
15	8
16	8
17	8
(18)	8
(19)	8
20	4
31	10
32	10
33	10
34	10
35	10
36	10
41	16

 **Note:** Figure 7.8.5-2 is limited to the listed numbers and will remain unchanged. Those numbers in parentheses are not yet assigned. GS1 Application Identifiers starting with two digits that are not included in figure 7.8.5-2 have a variable length even if the definition of the GS1 Application Identifier specifies a fixed length data field.

7.8.6 Concatenation

7.8.6.1 Predefined length element strings

Concatenated element strings constructed from GS1 Application Identifiers with a predefined length SHOULD NOT use a separator character following the element string of predefined length. Each element string is immediately followed by either the next GS1 Application Identifier or the symbol check character and stop character.

For example, concatenation of net weight (4.00 kilograms) with the associated Global Trade Item Number (GTIN) 95012345678903 SHOULD NOT include the use of a separator character.

- (01) has a predefined element string length of 16 digits.
- (31nn) has a predefined element string length of 10 digits.

Figure 7.8.6.1-1. Data encoded in two GS1-128 symbols



Figure 7.8.6.1-2. Data encoded in one concatenated GS1-128 symbol



7.8.6.2 Non-predefined length element strings

An element string that does not start with two characters defined in figure 7.8.5-2 SHALL be terminated by a separator character, unless it is the last element string to be encoded, when a separator character SHOULD NOT be used. The separator character is placed immediately after a non-predefined length element string and is followed by the GS1 Application Identifier of the next element string. The separator character used is either the Function 1 Symbol Character (FNC1) or the control character <GS> (ASCII value 29 (decimal), 1D (hexadecimal)) and it is always represented in the transmitted message by the control character <GS> (ASCII value 29 (decimal), 1D (hexadecimal)). If the element string is the last to be encoded, it is followed by the Symbol Check and stop characters.

For example, concatenation of price per unit of measure (365 currency units) and batch number (123456) MUST use a separator character immediately after the price per unit of measure.

Figure 7.8.6.2-1. Data encoded in two GS1-128 symbols



Figure 7.8.6.2-2. Data encoded in one concatenated GS1-128 symbol



 **Note:** The FNC1 is not shown in human readable interpretation.

7.8.6.3 Other considerations when using concatenation

Concatenation is an effective means for presenting multiple element strings in a single barcode and is used to conserve label space and optimise scanning operations when permitted by the application standard.

When concatenating a mixture of predefined length and other element strings, the predefined element strings SHOULD appear together before the other element strings. This usually results in a shorter linear barcode.

The separator character appears in the decoded data string as control character <GS> (ASCII value 29, (decimal), 1D (hexadecimal)). A separator character SHOULD NOT be used at the end of the last element string encoded in a GS1 barcode.

Notwithstanding the above, the processing routine SHALL tolerate a single separator character immediately following any element string, whether necessary or not, and process the data in accordance with section [7.8 Processing of data from a GS1 symbology using GS1 Application Identifiers](#).

Figure 7.8.6.3-1. Example of GS1 DataBar Expanded Stacked barcode that uses concatenation



Concatenation may not be desirable in all circumstances (e.g., GS1 Logistic Labels are often constructed using multiple rows of barcode), in such cases the barcode containing the additional attribute data encoded using GS1 Application Identifiers SHOULD be printed in close proximity to the barcode containing the GS1 identification key.

Figure 7.8.6.3-2. Example of mixed GS1 symbologies
(GTIN encoded in UPC-E, Best before date in Composite)



7.8.7 GS1 Application Identifiers with implied decimal point positions

For all GS1 Application Identifiers with an implied decimal point position, the following rules apply:

For predefined length AIs

- For predefined length GS1 Application Identifiers with a data field length of 9 or less, the maximum number of decimal places is equal to the length of the AI data field as indicated in the format of the GS1 Application Identifier, minus 1. For example, for an AI with data format N8 the maximum number of decimal places is 7.
- For predefined length GS1 Application Identifiers with a length greater than 9, the maximum number of decimal places is 9. For example, for an AI with data format N12 the maximum number of decimal places is 9.

Example for predefined length AIs:

The data field format of AI (394n) is N4, so the maximum number of implied decimal places is 3.

Element string (3943)1020 specifies that the data field includes 3 decimal places and therefore has an implied decimal point after the first digit: 1.020

For variable-length AIs

- For variable-length GS1 Application Identifiers with encoded data of 9 digits or less, the maximum number of decimal places is equal to the length of the encoded data, minus 1. For example, for a data field containing 4 digits the maximum number of decimal places is 3.
- For variable-length GS1 Application Identifiers with encoded data of more than 9 digits, the maximum number of decimal places is 9. For example, for a data field containing 11 digits the maximum number of decimal places is 9.

Example for variable-length AIs:

The data field format of AI (392n) is N..15, so the maximum number of implied decimal places is 9. Element string (3929)300123456789 specifies a data field of 12 digits that includes 9 decimal places and therefore has an implied decimal point after the third digit: 300.123456789.

Element string (3923)3000200 specifies a data field of 7 digits that includes 3 decimal places and therefore has an implied decimal point after the fourth digit: 3000.200

- ✔ **Note:** Consult the specific GS1 Application Identifier for additional restrictions that may apply to that GS1 Application Identifier.

7.8.8 National Healthcare Reimbursement Number (NHRN)

Some national or regional regulatory organisations may require pharmaceuticals and/or medical devices be identified with locally specific National Healthcare Reimbursement Numbers (NHRNs). For

compliance with these national/regional regulatory or industry requirements where the GTIN does not meet current need, the trade item SHALL be identified with GTIN and AIs (710), (711), (712), (713), (714), (715) and (716) National Healthcare Reimbursement Number.

One or more NHRNs may be associated with a single GTIN and encoded within the appropriate GS1 Data carrier in order to meet multiple market business needs. See figure below for examples of multiple NHRNs.

Additional individual NHRN AIs can only be assigned by GS1 and only in response to a work request being submitted through GSMP.

Figure 7.8.8-1. Examples of valid messages

Element strings in message								Comment
AI 01	AI 710							GTIN Identification of a trade item + Country "A" NHRN
AI 01	AI 710	AI 711						GTIN Identification of a trade item + Country "A" NHRN + Country "B" NHRN
AI 01	AI 710	AI 711	AI 712					GTIN Identification of a trade item + Country "A" NHRN + Country "B" NHRN + Country "C" NHRN
AI 01	AI 710	AI 711	AI 712	AI 713				GTIN Identification of a trade item + Country "A" NHRN + Country "B" NHRN + Country "C" NHRN + Country "D" NHRN
AI 01	AI 710	AI 711	AI 712	AI 713	AI 714			GTIN Identification of a trade item + Country "A" NHRN + Country "B" NHRN + Country "C" NHRN + Country "D" NHRN + Country "E" NHRN
AI 01	AI 710	AI 711	AI 712	AI 713	AI 714	AI 715		GTIN Identification of a trade item + Country "A" NHRN + Country "B" NHRN + Country "C" NHRN + Country "D" NHRN + Country "E" NHRN + Country "F" NHRN
AI 01	AI 710	AI 711	AI 712	AI 713	AI 714	AI 715	AI 716	GTIN Identification of a trade item + Country "A" NHRN + Country "B" NHRN + Country "C" NHRN + Country "D" NHRN + Country "E" NHRN + Country "F" NHRN + Country "G" NHRN

7.9 Check digit/character calculations

7.9.1 Standard check digit calculations for GS1 data structures

This algorithm is identical for all fixed length numeric GS1 data structures (including GDTI, GLN, GRAI, etc.) that require a check digit.

Figure 7.9.1-1. Check digit algorithm

	Digit positions																															
GTIN-8																			N ₁	N ₂	N ₃	N ₄	N ₅	N ₆	N ₇	N ₈						
GTIN-12																			N ₁	N ₂	N ₃	N ₄	N ₅	N ₆	N ₇	N ₈	N ₉	N ₁₀	N ₁₁	N ₁₂		
GTIN-13																			N ₁	N ₂	N ₃	N ₄	N ₅	N ₆	N ₇	N ₈	N ₉	N ₁₀	N ₁₁	N ₁₂	N ₁₃	
GTIN-14																			N ₁	N ₂	N ₃	N ₄	N ₅	N ₆	N ₇	N ₈	N ₉	N ₁₀	N ₁₁	N ₁₂	N ₁₃	N ₁₄
17 digits		N ₁	N ₂	N ₃	N ₄	N ₅	N ₆	N ₇	N ₈	N ₉	N ₁₀	N ₁₁	N ₁₂	N ₁₃	N ₁₄	N ₁₅	N ₁₆	N ₁₇														
18 digits	N ₁	N ₂	N ₃	N ₄	N ₅	N ₆	N ₇	N ₈	N ₉	N ₁₀	N ₁₁	N ₁₂	N ₁₃	N ₁₄	N ₁₅	N ₁₆	N ₁₇	N ₁₈														
	Multiply value of each position by																															
	x3	x1	x3	x1	x3	x1	x3	x1	x3	x1	x3	x1	x3	x1	x3	x1	x3															
	Accumulated results = sum																															
	Subtract sum from nearest equal or higher multiple of ten = check digit →																															

Figure 7.9.1-2. Check digit calculation example

Example of a check digit calculation for the 18-digit field																		
Positions	N ₁	N ₂	N ₃	N ₄	N ₅	N ₆	N ₇	N ₈	N ₉	N ₁₀	N ₁₁	N ₁₂	N ₁₃	N ₁₄	N ₁₅	N ₁₆	N ₁₇	N ₁₈
Number without check digit	3	7	6	1	0	4	2	5	0	0	2	1	2	3	4	5	6	
Step 1: multiply by	x	x	x	x	x	x	x	x	x	x	x	x	x	x	x	x	x	
	3	1	3	1	3	1	3	1	3	1	3	1	3	1	3	1	3	
Step 2: add up results to sum	=	=	=	=	=	=	=	=	=	=	=	=	=	=	=	=	=	
	9	7	18	1	0	4	6	5	0	0	6	1	6	3	12	5	18	= 101
Step 3: Subtract sum from nearest equal or higher multiple of ten (110) = check digit (9)																		
Number with check digit	3	7	6	1	0	4	2	5	0	0	2	1	2	3	4	5	6	9

7.9.2 Check digit calculation for price/weight fields

To increase the security of reading a price or weight from a barcode, the check digit for these fields is not only calculated according to the methods described in the previous section, but also according to the procedure described in this section.

The basic principle of the check digit calculation is that each digit position in a price/weight field is assigned a weighting factor. Weighting factors are **2-**, **3**, **5+** and **5-**. Each weighting factor affects the particular calculation for the position concerned. The result of such a calculation is called a weighted product. The figures that follow show the weighted products of the various weighting factors.

Figure 7.9.2-1. Weighting factor 2

Weighting factor 2										
Calculation rule: The digit is multiplied by 2. If the result has two digits, the tens digit is subtracted from the units digit. The units digit resulting is the weighted product.										
Digit	0	1	2	3	4	5	6	7	8	9
Weighted product	0	2	4	6	8	9	1	3	5	7

Figure 7.9.2-2. Weighting factor 3

Weighting factor 3										
Calculation rule: The digit is multiplied by 3. The unit's digit of the result is the weighted product.										
Digit	0	1	2	3	4	5	6	7	8	9
Weighted product	0	3	6	9	2	5	8	1	4	7

Figure 7.9.2-3. Weighting factor 5+

Weighting factor 5+										
Calculation rule: The digit is multiplied by 5. The units digit and the tens digit of the result are added together. The result of this sum is the weighted product.										
Digit	0	1	2	3	4	5	6	7	8	9
Weighted product	0	5	1	6	2	7	3	8	4	9

Figure 7.9.2-4. Weighting factor 5-

Weighting factor 5-										
Calculation rule: The digit is multiplied by 5. The tens digit of the result is subtracted from the result. The unit's digit of the result of this subtraction is the weighted product.										
Digit	0	1	2	3	4	5	6	7	8	9
Weighted product	0	5	9	4	8	3	7	2	6	1

7.9.3 Check digit calculation for the four-digit price field

Figure 7.9.3-1. Assigned weighting factors

Assigned weighting factors				
Digit position	1	2	3	4
Weighting factor	2-	2-	3	5-

- **Calculation step 1:** Determine the weighted product for each number in Positions One to Four according to the assigned weighting factors.
- **Calculation step 2:** Add the products of step 1.
- **Calculation step 3:** Multiply the result of step 2 by the factor 3. The unit's digit of the result is the check digit.

Figure 7.9.3-2. Example of a check digit calculation

Example of a check digit calculation					
Position of price field	1	2	3	4	
Assigned weighting factor	2-	2-	3	5-	
Amount	2	8	7	5	
Step 1: weighted product according to figure	4	5	1	3	
Step 2: sum	+	+	+	+	= 13
Step 3: multiply by 3					= 39 (*)
(*) Unit position is the check digit.					

7.9.4 Check digit calculation for the five-digit price field

Figure 7.9.4-1. Assigned weighting factors

Assigned weighting factors					
Digit positions	1	2	3	4	5
Weighting factor	5+	2-	5-	5+	2-

- **Calculation step 1:** Determine the weighted product for each number in positions one to five according to the assigned weighting factors.
- **Calculation step 2:** Add the products of step 1.
- **Calculation step 3:** Subtract the result from the nearest equal or higher multiple of 10.
- **Calculation step 4:** Take the result and search for the same number in the weighted product row of figure 7.9.2-4. The check digit is the number in the digit row of the same column.

Figure 7.9.4-2. Example of a check digit calculation

Example of a check digit calculation						
Price field positions	1	2	3	4	5	
Assigned weighting factor	5+	2-	5-	5+	2-	
Amount	1	4	6	8	5	
Step 1: weighted product according to figure	5	8	7	4	9	
Step 2: sum	+	+	+	+	+	= 33
Step 3: result of subtraction (40 - 33)						= 7
Step 4: weighted product 7 in the figure weighting factor 5- shows number 6 to be the check digit.						

7.9.5 Check character calculation (for alphanumeric keys)

GS1's check character algorithm uses MOD 1021,32 to calculate the check character pair for use in alphanumeric data structures (GS1 AI encodable character set, see section 7.11). The check character pair utilises uppercase alpha and numeric characters (see figures below). The check character set reduces potential keying errors by removing 0, O and 1, I (similar looking numeric alpha characters) from the possible results. The check character pairing also becomes more readily recognised due to the uppercase alpha numeric character structure. The check character pair enables the detection of various keying and encoding errors, including but not limited to:

- Character substitution(s)
- Character transposition(s)
- Logical shifts
- Character addition(s)
- Character omission(s)

Check character calculation steps:

- **Calculation step 1:** For each character, retrieve the assigned reference value from table 7.9.5-1
- **Calculation step 2:** Each symbol character position is given a prime number weight. Beginning with the right most non-check character (X_j) and progressing left to first character (N_1) the prime weight increases 2, 3, 5, 7, 11, 13, to W_n ; " W_n " denotes the n^{th} prime number where " n " is the number of characters representing data not including the check character pair.
- **Calculation step 3:** Multiply each assigned reference value (from step 1) by the weight (from step 2).
- **Calculation step 4:** Total the results of the calculations in step 3.
- **Calculation step 5:** Perform a MOD **1021** on the sum of the products (step 4).
- **Calculation step 6:** The result of step 5 is the check character's reference value.
- **Calculation step 7:** Based on the check character's reference value (C_k), determine the GMN check character using the following:
 - a. $C_k = C_1 * 32 + C_2$, (C_1, C_2 are the assigned reference values for table 7.9.5-2)
 - i. $C_1 = \text{INT}(C_k / 32)$, (the whole number to the left of the decimal)
 - ii. $C_2 = C_k \text{ MOD } 32$
 - b. Retrieve the alphanumeric characters for X_{j+1} and X_{j+2} using C_1 and C_2

Figure 7.9.5-1. GS1 AI encodable character reference values

Character set	Assigned value	Character set	Assigned value	Character set	Assigned value
!	0	B	30	e	60
"	1	C	31	f	61
%	2	D	32	g	62
&	3	E	33	h	63
'	4	F	34	i	64
(5	G	35	j	65
)	6	H	36	k	66
*	7	I	37	l	67
+	8	J	38	m	68
,	9	K	39	n	69
-	10	L	40	o	70

.	11	M	41	p	71
/	12	N	42	q	72
0	13	O	43	r	73
1	14	P	44	s	74
2	15	Q	45	t	75
3	16	R	46	u	76
4	17	S	47	v	77
5	18	T	48	w	78
6	19	U	49	x	79
7	20	V	50	y	80
8	21	W	51	z	81
9	22	X	52		
:	23	Y	53		
;	24	Z	54		
<	25	_	55		
=	26	a	56		
>	27	b	57		
?	28	c	58		
A	29	d	59		

Figure 7.9.5-2. Check character reference values

Character set	Assigned value	Character set	Assigned value	Character set	Assigned value
2	0	D	11	Q	22
3	1	E	12	R	23
4	2	F	13	S	24
5	3	G	14	T	25
6	4	H	15	U	26
7	5	J	16	V	27
8	6	K	17	W	28
9	7	L	18	X	29
A	8	M	19	Y	30
B	9	N	20	Z	31
C	10	P	21		

Figure 7.9.5-3. Example of a check character calculation (based on 25 character Global Model Number)

Position	P ₁	P ₂	P ₃	P ₄	P ₅	P ₆	P ₇	P ₈	P ₉	P ₁₀	P ₁₁	P ₁₂	P ₁₃	P ₁₄
GMN	1	9	8	7	6	5	4	A	d	4	X	4	b	L
Assigned value	14	22	21	20	19	18	17	29	59	17	52	17	57	40
Multiply by weighting factor (W _n)	X	X	X	X	X	X	X	X	X	X	X	X	X	X
	83	79	73	71	67	61	59	53	47	43	41	37	31	29
Results to sum	1162	1738	1533	1420	1273	1098	1003	1537	2773	731	2132	629	1767	1160

Example of a check character calculation for 25-character GMN continued

Position	P ₁₅	P ₁₆	P ₁₇	P ₁₈	P ₁₉	P ₂₀	P ₂₁	P ₂₂	P ₂₃	P ₂₄	P ₂₅
GMN	5	t	t	r	2	3	1	0	c	2	K



Assigned value	18	75	75	73	15	16	14	13	58
Multiply by weighting factor (W_n)	X	X	X	X	X	X	X	X	X
Results to sum	23	19	17	13	11	7	5	3	2
	414	1425	1275	949	165	112	70	39	116

Summary totals

Sum weighted assigned values	24521
MOD 1021 for the sum weighted assigned values	17
Integer Results of MOD 1021 Sum weighted assigned values divided by 32	0
Remainder of MOD 1021 Sum weighted assigned values multiplied by 32	17
Check character for position P24 referenced from Figure 7.9.5-2	2
Check character for position P25 referenced from Figure 7.9.5-2	K

7.10 GTIN-12 and RCN-12 in a UPC-E barcode

Some of the GTIN-12 and RCN-12 number ranges beginning with the U.P.C. Prefix 0 may be represented in a small symbol called the UPC-E barcode (see section [2.1](#)).

The GTIN-12 or RCN-12 is condensed into a barcode consisting of six symbol character positions. For application processing, the GTIN-12 or RCN-12 must be transformed into its full length by the barcode reader software or by the application software. There is no six-digit UPC-E barcode.

It is possible to create false UPC-E barcodes if the encodation rules are not properly observed. Whether the digits represented in a UPC-E barcode can be expanded correctly to a GTIN-12 is verified by the following tests.

Test 1:

Verify the digits encoded in Positions 1 to 6 of the UPC-E barcode according to the diagram below.

Figure 7.10-1. Procedure for test 1

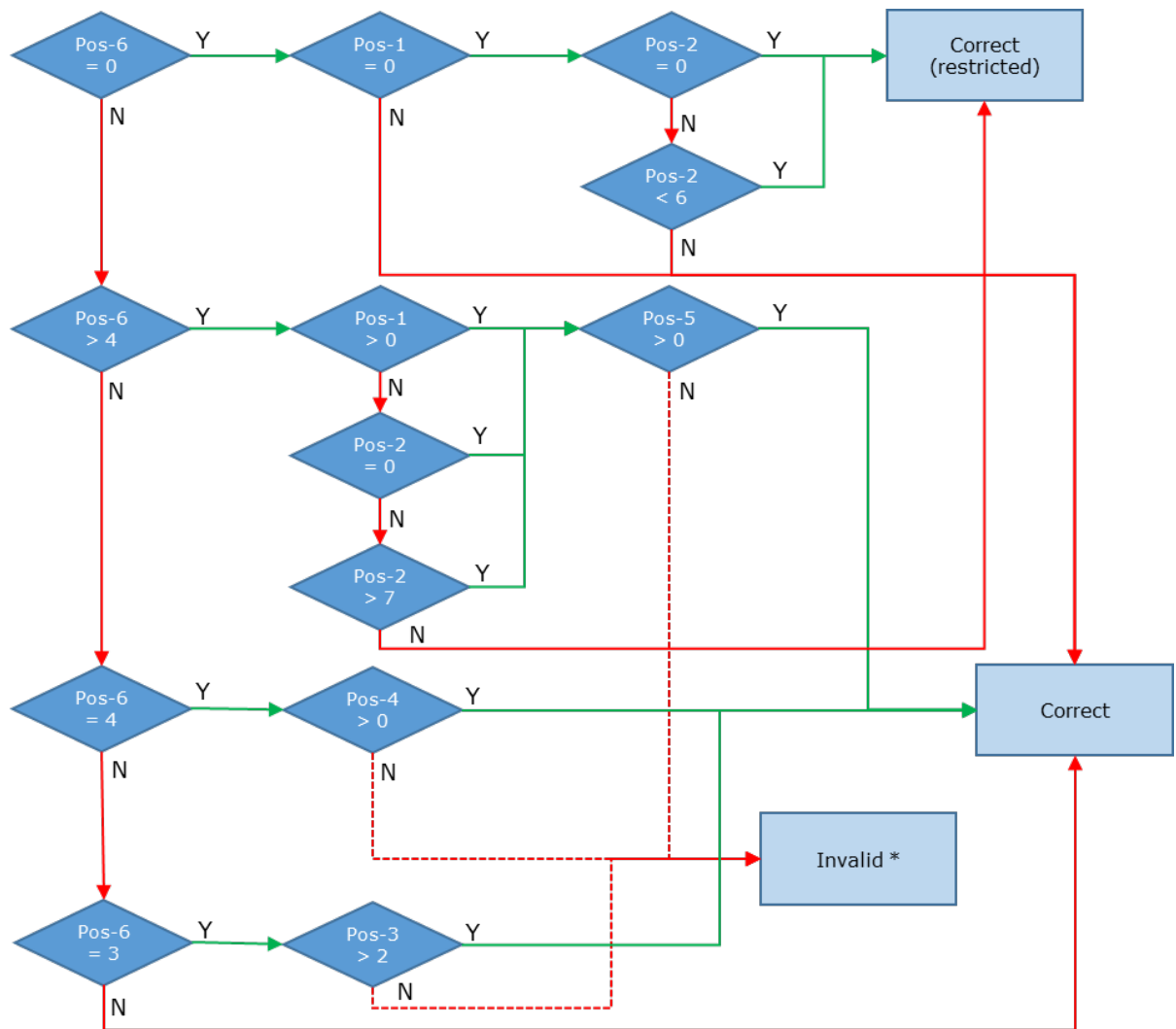

* These UPC-E barcodes were valid in previous specifications. Provision for accepting them must be made during decoding only.

Test 2:

Expand the digits encoded in the UPC-E barcode to the first 11 digits of the full length GTIN-12, calculate the check digit and compare it with the check digit decoded from the UPC-E barcode. If they do not match, it signifies an invalid symbol.

7.11 The GS1 subset of International Standard ISO/IEC 646

Figure 7.11-1 lists all characters allowed for use in GS1 Application Identifier (AI) element strings with the exception of the Component and Parts Identifier and Digital Signatures (DigSig). Figure 7.11-1 corresponds to ISO/IEC 646 Table 1. All other ISO 646 characters that are not listed here are not allowed in GS1 Application Identifier (AI) element strings. Figure 7.11-2 lists all the characters allowed for use in the GS1 Application Identifier for Component and Parts Identifier. Figure 7.11-3 lists all the characters allowed for use in the GS1 Application Identifier (AI) for Digital Signatures (DigSig).

Note that some transport process information may include accented / non-Latin characters and space characters which are not available in the subset of ISO/IEC 646 International Reference Version defined in the figure below. Some AIs in the range 4300 – 4320 may use the characters from the figure below in conjunction with percent-encoding as defined in RFC 3986 in order to

support non-Latin characters, with the plus sign (+) being accepted as a way of encoding a literal space character.

Figure 7.11-1. GS1 AI encodable character set 82

Graphic symbol	Name	Coded representation	Graphic symbol	Name	Coded representation
!	Exclamation mark	2/1	M	Capital letter M	4/13
"	Quotation mark	2/2	N	Capital letter N	4/14
%	Percent sign	2/5	O	Capital letter O	4/15
&	Ampersand	2/6	P	Capital letter P	5/0
'	Apostrophe	2/7	Q	Capital letter Q	5/1
(Left parenthesis	2/8	R	Capital letter R	5/2
)	Right parenthesis	2/9	S	Capital letter S	5/3
*	Asterisk	2/10	T	Capital letter T	5/4
+	Plus sign	2/11	U	Capital letter U	5/5
,	Comma	2/12	V	Capital letter V	5/6
-	Hyphen/Minus	2/13	W	Capital letter W	5/7
.	Full stop	2/14	X	Capital letter X	5/8
/	Solidus	2/15	Y	Capital letter Y	5/9
0	Digit zero	3/0	Z	Capital letter Z	5/10
1	Digit one	3/1	_	Low line	5/15
2	Digit two	3/2	a	Small letter a	6/1
3	Digit three	3/3	b	Small letter b	6/2
4	Digit four	3/4	c	Small letter c	6/3
5	Digit five	3/5	d	Small letter d	6/4
6	Digit six	3/6	e	Small letter e	6/5
7	Digit seven	3/7	f	Small letter f	6/6
8	Digit eight	3/8	g	Small letter g	6/7
9	Digit nine	3/9	h	Small letter h	6/8
:	Colon	3/10	i	Small letter i	6/9
;	Semicolon	3/11	j	Small letter j	6/10
<	Less-than sign	3/12	k	Small letter k	6/11
=	Equals sign	3/13	l	Small letter l	6/12
>	Greater-than sign	3/14	m	Small letter m	6/13
?	Question mark	3/15	n	Small letter n	6/14
A	Capital letter A	4/1	o	Small letter o	6/15
B	Capital letter B	4/2	p	Small letter p	7/0
C	Capital letter C	4/3	q	Small letter q	7/1
D	Capital letter D	4/4	r	Small letter r	7/2
E	Capital letter E	4/5	s	Small letter s	7/3
F	Capital letter F	4/6	t	Small letter t	7/4
G	Capital letter G	4/7	u	Small letter u	7/5
H	Capital letter H	4/8	v	Small letter v	7/6
I	Capital letter I	4/9	w	Small letter w	7/7
J	Capital letter J	4/10	x	Small letter x	7/8
K	Capital letter K	4/11	y	Small letter y	7/9
L	Capital letter L	4/12	z	Small letter z	7/10

Figure 7.11-2. GS1 AI encodable character set 39

Graphic symbol	Name	Coded representation	Graphic symbol	Name	Coded representation
#	Number Sign	2/3	H	Capital letter H	4/8
-	Hyphen/Minus	2/13	I	Capital letter I	4/9
/	Solidus	2/15	J	Capital letter J	4/10
0	Digit zero	3/0	K	Capital letter K	4/11
1	Digit one	3/1	L	Capital letter L	4/12
2	Digit two	3/2	M	Capital letter M	4/13
3	Digit three	3/3	N	Capital letter N	4/14
4	Digit four	3/4	O	Capital letter O	4/15
5	Digit five	3/5	P	Capital letter P	5/0
6	Digit six	3/6	Q	Capital letter Q	5/1
7	Digit seven	3/7	R	Capital letter R	5/2
8	Digit eight	3/8	S	Capital letter S	5/3
9	Digit nine	3/9	T	Capital letter T	5/4
A	Capital letter A	4/1	U	Capital letter U	5/5
B	Capital letter B	4/2	V	Capital letter V	5/6
C	Capital letter C	4/3	W	Capital letter W	5/7
D	Capital letter D	4/4	X	Capital letter X	5/8
E	Capital letter E	4/5	Y	Capital letter Y	5/9
F	Capital letter F	4/6	Z	Capital letter Z	5/10
G	Capital letter G	4/7	Intentionally left blank		

Figure 7.11-3. GS1 AI encodable character set 64 (file-safe / URI-safe base64)

Value	Graphic symbol	Name	Coded representation	Value	Graphic symbol	Name	Coded representation
0	A	Capital letter A	4/1	32	g	Small letter g	6/7
1	B	Capital letter B	4/2	33	h	Small letter h	6/8
2	C	Capital letter C	4/3	34	i	Small letter i	6/9
3	D	Capital letter D	4/4	35	j	Small letter j	6/10
4	E	Capital letter E	4/5	36	k	Small letter k	6/11
5	F	Capital letter F	4/6	37	l	Small letter l	6/12
6	G	Capital letter G	4/7	38	m	Small letter m	6/13
7	H	Capital letter H	4/8	39	n	Small letter n	6/14
8	I	Capital letter I	4/9	40	o	Small letter o	6/15
9	J	Capital letter J	4/10	41	p	Small letter p	7/0
10	K	Capital letter K	4/11	42	q	Small letter q	7/1
11	L	Capital letter L	4/12	43	r	Small letter r	7/2
12	M	Capital letter M	4/13	44	s	Small letter s	7/3
13	N	Capital letter N	4/14	45	t	Small letter t	7/4
14	O	Capital letter O	4/15	46	u	Small letter u	7/5
15	P	Capital letter P	5/0	47	v	Small letter v	7/6
16	Q	Capital letter Q	5/1	48	w	Small letter w	7/7
17	R	Capital letter R	5/2	49	x	Small letter x	7/8
18	S	Capital letter S	5/3	50	y	Small letter y	7/9
19	T	Capital letter T	5/4	51	z	Small letter z	7/10
20	U	Capital letter U	5/5	52	0	Digit zero	3/0

Value	Graphic symbol	Name	Coded representation	Value	Graphic symbol	Name	Coded representation
21	V	Capital letter V	5/6	53	1	Digit one	3/1
22	W	Capital letter W	5/7	54	2	Digit two	3/2
23	X	Capital letter X	5/8	55	3	Digit three	3/3
24	Y	Capital letter Y	5/9	56	4	Digit four	3/4
25	Z	Capital letter Z	5/10	57	5	Digit five	3/5
26	a	Small letter a	6/1	58	6	Digit six	3/6
27	b	Small letter b	6/2	59	7	Digit seven	3/7
28	c	Small letter c	6/3	60	8	Digit eight	3/8
29	d	Small letter d	6/4	61	9	Digit nine	3/9
30	e	Small letter e	6/5	62	-	Hyphen/minus	2/13
31	f	Small letter f	6/6	63	_	Low line / underscore / underline	5/15
Intentionally left blank				N/A	=	Equals (pad character)	3/13

-  **Note 1:** The permitted characters for use with AI (8030) Digital Signature (DigSig) are the GS1 encodable character set 64 (file-safe / URI-safe base64) ordered alphabet as defined in section 5 of [RFC 4648](#), which consists of the upper-case letters A-Z, lower-case letters a-z, digits 0-9, hyphen (-), low line/underscore/underline (_) and the equals character (=) as a special pad character (Figure 7.11-3).

These 65 characters – a total of 64 characters and the special pad character - are a subset of the GS1 AI encodable character set 82 (Figure 7.11-1). A maximum length of 90 characters corresponds to a maximum capacity of 540 bits. Although a Digital Signature (DigSig) AI (8030) value may contain a Base64 pad character (=), it can be removed without causing any loss of information. When expressed within the query string of a GS1 Digital Link URI, the Base64 pad character (=) SHOULD be removed, in accordance with section 5 of [RFC 4648](#), however if it is required, the Base64 pad character SHALL be percent-encoded, as defined in [RFC 3986](#)

Note also that these characters are not freely chosen by the user but are instead a compact representation of a binary value for the calculated ISO/IEC 20248 data construct which contains the digital signature, expressed using one file-safe/URI-safe base64 character per 6 bits.

7.12 Determination of century in dates

Element strings are available for the following types of dates:

- Production date: AI (11).
- Due date: AI (12).
- Packaging date: AI (13).
- Best before date: AI (15).
- Sell by date: AI (16).
- Expiration date: AI (17).
- Expiration date and time: AI (7003).
- First freeze date: AI (7006).
- Harvest date: AI (7007).

- Date and time of production: AI (8008).

It is left to the discretion of the user to interpret a particular date type in the sense of his business practices. Such interpretation may change according to the product range for which a date is being applied.

Since the year data field consists of two positions, the century is established by following the procedure in the figure below.

Figure 7.12-1. Determination of century

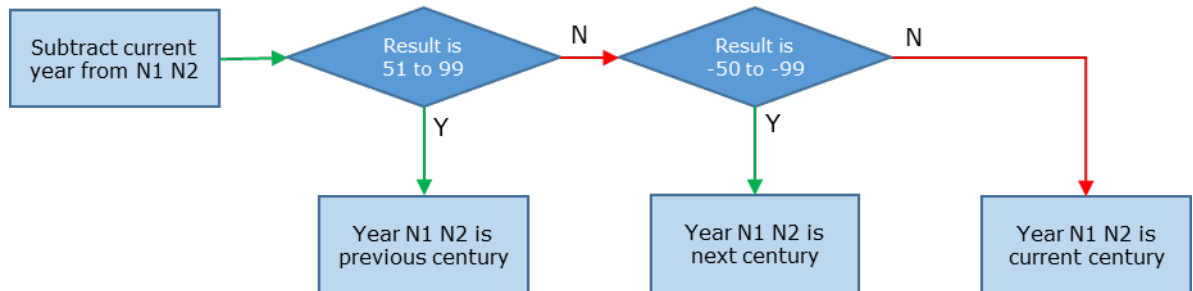

- ✔ **Note:** The element string can only specify a date in the range from 49 years in the past to 50 years in the future of the current year

7.13 Conversion of latitude and longitude to twenty-digit string

A latitude and longitude (both expressed in decimal degrees using the WGS84 coordinate reference system) can be converted into two 10-digit fields, X and Y as follows:

- $X = 10,000,000 * (\text{WGS84 latitude} + 90)$
- $Y = 10,000,000 * ((\text{WGS84 longitude} + 360) \bmod 360)$
- X and Y SHALL be integer values.

- ✔ **Note:** The WGS84 latitude and longitude SHOULD be expressed with no more than 7 decimal places.

If the calculation of either X or Y results in fewer than 10 digits then the value must be left-padded with '0' to reach a total of 10 digits per value.

For GS1 AIs encoding geocoordinates, X and Y are concatenated into a single string of twenty digits.

For example, Machu Picchu Antarctica Base's latitude (-62.0914152°) and longitude (-58.4702029°) would be converted to 0279085848 and 3015297971, resulting in a final data element of 02790858483015297971

7.14 Conversion of twenty-digit string to latitude and longitude

A twenty digit geocode contains two ten-digit fields, X and Y, that can be converted to latitude and longitude values in the [WGS84](#) coordinate reference system (expressed in decimal degrees) using the following calculations:

- X, the first 10 digits can be converted to WGS84 latitude using the following calculation:
 - $\text{WGS84 latitude} = ((X/10,000,000) - 90)^\circ$
- Y, the second group of 10 digits can be converted to WGS84 longitude using the following calculation:
 - $\text{WGS84 longitude} = (((Y/10,000,000)+180) \bmod 360) - 180)^\circ$

8 Application Standard Profiles

8.1 Introduction

When a company requires or claims conformance to GS1 standards, it is important to understand what conformance means. The AIDC application standards in section 2 specify the application scope, required identifier, mandatory/optional attributes, data carrier (e.g., EAN/UPC, GS1 DataMatrix) options, data carriers specifications (e.g., print quality, size range) and rules such as GS1 identification key allocation. These and other GS1 standards provide the basis to measure conformance in a consistent way.

For example, retailers require suppliers to place an EAN/UPC barcode carrying a GTIN on the consumer package as the retailer requires the GTIN for point-of-sale (POS) and inventory transactions such as orders and invoices. The EAN/UPC barcode must also be printed to a minimum quality specification to ensure it can fulfil its purpose.

 **Note:** Implementation of GS1 standards is voluntary unless related to a specific regulation. National, federal or local regulations may take precedence over GS1 standards.

The Application Standard Profiles (ASPs) specify what is conformant for current and, where appropriate, future state implementations. These ASPs are designed for all stakeholders involved in the implementation process. This could be a supplier of a consumer product making sure the right identifier, attributes, barcode type and barcode size/quality are implemented on the package or a quality control function assessing the package. It could also be a solution provider who is ensuring their barcode design, printing, verification, or scanning systems accommodate the identifiers, attributes, barcodes and sizes specified by ASPs relevant to the product they are offering. These ASPs provide ways to simplify specifications for hardware and software purchases by referencing conformance requirements for ASPs relevant to the performance of a system.

Beyond documenting current AIDC application standard conformance requirements mentioned above, ASPs provide:

1. **Conformance requirements:** Provides normative reference(s) for conformance requirements, available identifiers, attributes and data carrier choices and quality specifications.
2. **Future state conformance requirements:** Documents future conformance requirements that support migration to an additional data carrier or syntax. These requirements enable a standardised migration to a new capability. For example, the retail sector may determine 2D barcodes could add significant value to an application area, ASP is used to document the conformance requirements for which barcodes will be used for the migration period to support backward compatibility and more. Once specified data carrier or syntax is pervasive enough to be used in an open value chain, the future state conformance requirements will become part of the global application standard.
3. **Cross-application rules:** Provides references to rules that apply across application standards such as multiple barcode management rules, GS1 identification key allocation rules, symbol placement rules and more.
4. **Technical Specifications:** Provides references to technical standards related to the application such as the GS1 Application Identifier list, symbology specifications and more.

ASPs are listed sequentially as they are approved. This modular approach creates persistent ASP references. For example, vendor requirement documents or system purchase agreements that reference ASPs to specify requirements will remain relevant independent of future ASP additions.

The ASP tables provide the following references:

- **Basis of conformance requirements:** Each ASP is based on one or more normative AIDC application standards. These are typically found in section 2 of this document but may also be in stand-alone documents. References to normative application standards are provided in each ASP table.
- **Identifier choices:** AIDC application standards contain a required GS1 identification key such as GTIN for trade items, SSCC for logistic units, GLN for physical locations and more. In the case of GTIN, there may be up to four different formats, GTIN-8, GTIN-12, GTIN-13 and GTIN-

14. In some cases, all four can be used, but in other cases, only one, two, or three formats are permitted.

- **Mandatory attribute(s):** An identifier is always required and in some applications an attribute is mandatory. For example, variable measure trade items with a GTIN also require an attribute for weight or measure.
- **Optional attribute(s):** Section 3.2 provides a list of all GS1 Application Identifiers and data that is defined by GS1 for use in barcodes. All attributes that support the GS1 identification key in use are optional if not listed as mandatory. The party responsible for labelling the object is responsible for determining if optional attributes are needed.
- **Data carrier choices:** There are various data carriers approved within GS1 AIDC application standard. Each AIDC application standard records which data carriers are conformant. In some cases, there may also be one required data carrier and another that can be used in addition to the first.
- **Barcode size and quality specifications:** Each AIDC application standard that includes a barcode has specifications for size and print quality minimums. Conformity to these specifications and proper placement ensures the barcode has a high likelihood of scanning successfully in the required scan environment.
- **GS1 syntax:** GS1 AIDC data carriers support four different syntaxes. Each syntax defines a structured approach to representing data when it is encoded so that it can be correctly interpreted and processed when it is decoded.

8.2 ASP 1: Fixed measure trade items scanned at retail POS

ASP 1 applies to trade items that are intended for scanning at retail point-of-sale, are fixed measure (i.e., not sold based on variable weight or variable measure) and are not intended for general distribution scanning. Examples include trade items such as milk, soup cans, a hat, a lamp, a tennis racket, a battery pack, or a toy.

 **Note:** ASP 1 does not apply to products sold or dispensed in a controlled environment (e.g., pharmacy, hospital) nor does it apply to books and serial publications where additional identification, data carrier, specifications and/or rules apply.

Figure 8.2.1 ASP 1 conformance requirements

Conformance requirements	General retail products
Basis of conformance requirements	Section 2.1.3.1 Fixed measure trade items scanned at retail POS using GTIN-12 or GTIN-13 Section 2.1.3.2 Fixed measure trade items scanned at retail POS using GTIN-12 carried by a UPC-E barcode Section 2.1.3.3 Fixed measure trade items scanned at retail POS using GTIN-8 Section 2.1.3.6 Fixed measure fresh food trade items scanned at retail POS
Identifier choices	GTIN-8, GTIN-12, GTIN-13
Mandatory attribute(s)	N/A
Optional attribute(s)	See section 3.2 for the list of GS1 Application Identifiers that may be used with the identifier
Mandatory choices for a data carrier	EAN-8, EAN-13, UPC-A, UPC-E, GS1 DataBar Omnidirectional, GS1 DataBar Stacked Omnidirectional, GS1 DataBar Expanded, GS1 DataBar Expanded Stacked

Conformance requirements	General retail products
Agreement on conformant data carriers in the future	<p>Any one of the mandatory data carriers or any one of the data carriers below will be conformant in the future once POS system support for these three 2D barcodes below reached pervasive adoption and becomes part of the global application standards.</p> <p>In the migration period, one of the data carriers below may be used in addition to the mandatory data carrier selected.</p> <ul style="list-style-type: none"> □ GS1 DataMatrix □ Data Matrix (GS1 Digital Link URI) □ QR Code (GS1 Digital Link URI)
Barcode size and quality specifications	<p>Figure 5.12.3.1-1 Symbol specification table 1 contains barcode quality and size specifications for trade items scanned in general retail POS and not general distribution</p> <p>Figure 5.12.3.1-3 Symbol specification table 1 addendum 2 for 2D barcodes</p>
Mandatory choices for GS1 syntax	Plain, GS1 element string
Agreement on conformant syntax in the future	<p>Any one of the mandatory GS1 syntaxes or the uncompressed form of GS1 Digital Link URI syntax SHALL be conformant in the future once the POS system support for interoperability between all three GS1 syntaxes has reached pervasive adoption and becomes part of the global application standards.</p>



Note: A data carrier with GS1 Digital Link URI to support consumer mobile devices may be used in addition to the mandatory POS data carriers selected.

Figure 8.2.2 ASP 1 cross-application rules

Cross-application rules	Description	Section
GTIN rules	Rules for GTIN management of uniqueness and allocation, and responsibility for allocation.	4.2
	Rules that apply when a company changes legal status as a result of an acquisition, merger, partial purchase, split, or "spin-off."	1.6
Data relationships	Rules for allowed combinations of element strings on the same physical entity, irrespective of the data carrier(s) applied to the entity.	4.13
Human readable interpretation	Human readable interpretation (HRI) rules used to standardise printing requirements and facilitate training of staff on how to deal with GS1 AIDC data carriers that fail to scan or read.	4.14
Multiple barcode management	Rules for implementing multiple barcodes on the same trade item.	4.15
Barcode placement	Rules for barcode placement on trade items that will be scanned at point-of-sale.	6.3

Figure 8.2.3 ASP 1 related technical specifications

Related technical specifications	Description	Section
GS1 Application Identifiers in numerical order	This section describes the meaning, structure and function of the GS1 system element strings so they can be correctly processed in users' application programmes. An element string is the combination of a GS1 Application Identifier and a GS1 Application Identifier data field. Also see GS1 Application Identifiers browser	3.2
Data carrier specifications	EAN/UPC family technical specifications	5.2
	GS1 DataBar family technical specifications	5.5
Check digit calculations	The algorithm used for check digit calculations	7.9
The GS1 subset of International Standard ISO/IEC 646	Lists all characters allowed for use in GS1 Application Identifier (AI) element strings.	7.11

8.3 ASP 2: Fixed measure trade items scanned at retail POS and in general distribution

ASP 2 applies to trade items that are intended for scanning at retail point-of-sale and are fixed measure (i.e., not sold based on variable weight or variable measure). Unlike ASP 1 they are also intended for general distribution scanning. Examples of these products might be a microwave oven or large bag of animal feed.

Figure 8.3.1 ASP 2 conformance requirements

Conformance requirements	Fixed Measure POS and General Distribution
Basis of conformance requirements	Section 2.1.4 Fixed measure trade items scanned in general distribution and at retail POS
Identifier choices	GTIN-8, GTIN-12, GTIN-13
Mandatory attribute(s)	N/A
Optional attribute(s)	See section 3.2 for the list of GS1 Application Identifiers that may be used with the identifier
Mandatory choices for a data carrier	EAN-8, EAN-13, UPC-A, UPC-E, GS1 DataBar Omnidirectional, GS1 DataBar Stacked Omnidirectional, GS1 DataBar Expanded, GS1 DataBar Expanded Stacked
Agreement on conformant data carriers in the future	<p>Any one of the mandatory data carriers or any one of the data carriers below will be conformant in the future once POS and general distribution system support for these three 2D barcodes below reaches pervasive adoption and becomes part of the global application standards.</p> <p>In the migration period, one of the data carriers below may be used in addition to the mandatory data carrier selected.</p> <ul style="list-style-type: none"> <input type="checkbox"/> GS1 DataMatrix <input type="checkbox"/> Data Matrix (GS1 Digital Link URI) <input type="checkbox"/> QR Code (GS1 Digital Link URI)
Barcode size and quality specifications	Figure 5.12.3.3-1 , Symbol specification table 3 Figure 5.12.3.3-2 , Symbol specification table 3 addendum 1 for 2D barcodes
Mandatory choices for GS1 syntax	Plain, GS1 element string

Conformance requirements	Fixed Measure POS and General Distribution
Agreement on conformant syntax in the future	Any one of the mandatory GS1 syntaxes or the uncompressed form of GS1 Digital Link URI syntax SHALL be conformant in the future once the POS system support for interoperability between all three GS1 syntaxes has reached pervasive adoption and becomes part of the global application standards.

-  **Note:** A data carrier with GS1 Digital Link URI to support consumer mobile devices may be used in addition to the mandatory POS data carriers selected.

Figure 8.3.2 ASP 2 cross-application rules

Cross-application rules	Description	Section
GTIN rules	Rules for GTIN management of uniqueness and allocation, and responsibility for allocation.	4.2
	Rules that apply when a company changes legal status as a result of an acquisition, merger, partial purchase, split, or "spin-off."	1.6
Data relationships	Rules for allowed combinations of element strings on the same physical entity, irrespective of the data carrier(s) applied to the entity.	4.13
Human readable interpretation	Human readable interpretation (HRI) rules are provided to standardise printing requirements and facilitate training of staff on how to deal with GS1 AIDC data carriers that fail to scan or read.	4.14
Multiple barcode management	Rules for implementing multiple barcodes on the same trade item.	4.15
Barcode placement	Rules for barcode placement on trade items that will be scanned at point-of-sale.	6.3
	Rules for barcode placement on trade items that will be scanned in general distribution environments.	6.7

Figure 8.3.3 ASP 2 related technical specifications

Related technical specifications	Description	Section
GS1 Application Identifiers in numerical order	This section describes the meaning, structure and function of the GS1 system element strings so they can be correctly processed in users' application programmes. An element string is the combination of a GS1 Application Identifier and a GS1 Application Identifier data field. Also see GS1 Application Identifiers browser	3.2
Data carrier specifications	EAN/UPC family technical specifications	5.2
	GS1 DataBar family technical specifications	5.5
Check digit calculations	The algorithm used for check digit calculations	7.9

Related technical specifications	Description	Section
The GS1 subset of International Standard ISO/IEC 646	Lists all characters allowed for use in GS1 Application Identifier (AI) element strings.	7.11

8.4 ASP 3: Variable measure trade items scanned at retail POS

ASP 3 applies to trade items that are intended for scanning at retail point-of-sale, are variable measure (i.e., are sold based on variable weight or variable measure) and are not intended for general distribution scanning. Examples include fruits, vegetables, dairy items, bakery items, meat and poultry sold by weight or measure.

Figure 8.4.1 ASP 3 conformance requirements

Conformance requirements	Variable measure fresh food using GTIN + count/weight	Variable measure fresh food using restricted circulation number (RCN)
Basis of conformance requirements	Section 2.1.12.1 Variable measure fresh food trade items scanned at retail POS using GTIN	Section 2.1.12.2 Variable measure fresh food trade items scanned at retail POS using RCN
Identifier choices	GTIN-12, GTIN-13	RCN-12, RCN-13
Mandatory attribute(s)	SHALL have at least one of the following GS1 Application Identifiers: AI (30) / AI (31nn) / AI (32nn) / AI (35nn) /AI (36nn)	N/A
Optional attribute(s)	See section 3.2 for the list of GS1 Application Identifiers that may be used with the identifier	N/A
Mandatory choices for a data carrier	GS1 DataBar Expanded, GS1 DataBar Expanded Stacked	EAN-13, UPC-A
Agreement on conformant data carriers in the future	<p>Any one of the mandatory data carriers or any one of the data carriers below will be conformant in the future once POS system support for these three 2D barcodes below reaches pervasive adoption and becomes part of the global application standards.</p> <p>In the migration period, one of the data carriers below may be used in addition to the mandatory data carrier selected.</p> <ul style="list-style-type: none"> □ GS1 DataMatrix □ Data Matrix (GS1 Digital Link URI) □ QR Code (GS1 Digital Link URI) 	N/A
Barcode size and quality specifications	<p>Figure 5.12.3.1-1 Symbol specification table 1 contains barcode quality and size specifications for trade items scanned in general retail POS and not general distribution</p> <p>Figure 5.12.3.1-3 Symbol specification table 1 addendum 2 for 2D barcodes</p>	Figure 5.12.3.1-1 Symbol specification table 1 contains barcode quality and size specifications for trade items scanned in general retail POS and not general distribution
Mandatory choices for GS1 syntax	GS1 element string	Plain

Conformance requirements	Variable measure fresh food using GTIN + count/weight	Variable measure fresh food using restricted circulation number (RCN)
Agreement on conformant syntax in the future	GS1 element string or the uncompressed form of GS1 Digital Link URI syntax SHALL be conformant in the future once the POS system support for interoperability between these syntaxes has reached pervasive adoption and becomes part of the global application standards.	N/A



Note: A data carrier with GS1 Digital Link URI to support consumer mobile devices may be used in addition to the mandatory POS data carriers selected.

Figure 8.4.2 ASP 3 cross-application rules

Cross-application rules	Description	Section
GTIN rules	Rules for GTIN management of uniqueness and allocation, and responsibility for allocation.	4.2
	Rules that apply when a company changes legal status as a result of an acquisition, merger, partial purchase, split, or "spin-off."	1.6
Data relationships	Rules for allowed combinations of element strings on the same physical entity, irrespective of the data carrier(s) applied to the entity.	4.13
Human readable interpretation	Human readable interpretation (HRI) rules are used to standardise printing requirements and facilitate training of staff on how to deal with GS1 AIDC data carriers that fail to scan or read.	4.14
Multiple barcode management	Rules for implementing multiple barcodes on the same trade item.	4.15
Barcode placement	Rules for barcode placement on trade items that will be scanned at point-of-sale.	6.3

Figure 8.4.3 ASP 3 related technical specifications

Related technical specifications	Description	Section
GS1 Application Identifiers in numerical order	This section describes the meaning, structure and function of the GS1 system element strings so they can be correctly processed in users' application programmes. An element string is the combination of a GS1 Application Identifier and a GS1 Application Identifier data field. Also see GS1 Application Identifiers browser	3.2
Data carrier specifications	EAN/UPC family technical specifications	5.2
	GS1 DataBar family technical specifications	5.5
Check digit calculations	The algorithm used for check digit calculations	7.9
The GS1 subset of International Standard ISO/IEC 646	Lists all characters allowed for use in GS1 Application Identifier (AI) element strings.	7.11

8.5 ASP 4: General retail consumer trade item with extended packaging

Information on a trade item can be extended when the consumer scans a barcode to reach web resources online. For example, a shopper scans a box of packaged pasta to find a selection of recipes. For new extended packaging applications, a web-enabled approach using GS1 Digital Link URI syntax and QR Code or Data Matrix is used. For this reason, the ASP focuses solely on the forward-looking approach. Prior to the GS1 Digital Link URI standard, two approaches were available to reach extended packaging applications that were available within the GS1 system of standards. All legacy implementations of these approaches remain conformant but new implementations SHALL use the GS1 Digital Link URI approach.

Figure 8.5.1 ASP 4 conformance requirements

Conformance requirements	General retail products GS1 Digital Link URI
Basis of conformance requirements	Section 2.1.13.1 GS1 Digital Link URI syntax for extended packaging applications for trade items
Identifier choices	GTIN-8, GTIN-12, GTIN-13
Mandatory attribute(s)	N/A
Optional attribute(s)	See section 3.2 for the list of GS1 Application Identifiers that may be used with the identifier
Mandatory choices for a data carrier	QR Code (GS1 Digital Link URI), Data Matrix (GS1 Digital Link URI)
Barcode size and quality specifications	Figure 5.12.3.1-3 Symbol specification table 1 addendum 2 for 2D barcodes contains barcode quality and size specifications for 2D barcodes with GS1 Digital Link URI
Mandatory choices of GS1 syntax	This application SHALL use the uncompressed form of GS1 Digital Link URI, see GS1 Digital Link Standard: URI Syntax for more information

Figure 8.5.2 ASP 4 cross-application rules

Cross-application rules	Description	Section
GTIN rules	Rules for GTIN management of uniqueness and allocation, and responsibility for allocation.	4.2
	Rules that apply when a company changes legal status as a result of an acquisition, merger, partial purchase, split, or "spin-off."	1.6
Data relationships	Rules for allowed combinations of element strings on the same physical entity, irrespective of the data carrier(s) applied to the entity.	4.13
Human readable interpretation	Human readable interpretation (HRI) rules are provided to standardise printing requirements and facilitate training of staff on how to deal with GS1 AIDC data carriers that fail to scan or read.	4.14
Multiple barcode management	Rules for implementing multiple barcodes on the same trade item.	4.15

Figure 8.5.3 ASP 4 related technical specifications

Related technical specifications	Description	Section
GS1 Application Identifiers in numerical order	This section describes the meaning, structure and function of the GS1 system element strings so they can be correctly processed in users' application programmes. An element string is the combination of a GS1 Application Identifier and a GS1 Application Identifier data field. Also see GS1 Application Identifiers browser	3.2
Data carrier specifications	Data Matrix technical specifications	5.9
	QR Code technical specifications	5.10
Check digit calculations	The algorithm used for check digit calculations	7.9
The GS1 subset of International Standard ISO/IEC 646	Lists all characters allowed for use in GS1 Application Identifier (AI) element strings.	7.11
The GS1 regular expression test	The regular expression test is used to differentiate 2D barcodes encoded with GS1 Digital Link URI syntax and those not encoding GS1 data.	See GS1 Digital Link Standard: URI Syntax , section 6
The GS1 link type rules for GS1 Digital Link	Details on link types for use with GS1 Digital Link. Each link type property expresses a distinct kind of information resource found at the target resources URI.	GS1 Web Vocabulary for GS1 Digital Link "link type" rules

9 GS1 Standards glossary of terms

9.1 GS1 glossary of terms and definitions

The glossary lists the terms and definitions that are applied in this document. Please refer to the www.gs1.org/glossary for the online version.

Term	Definition
acceptance criteria	An allowance for a small measurement variation between commercial verifiers or operators during barcode verification testing.
add-on symbol	A barcode used to encode information supplementary to that in the main EAN/UPC barcode.
aggregated packaging (per EU 2018/574)	Any packaging containing more than one unit packet of tobacco products. For GS1, this may be either a trade item grouping or logistics unit.
AIDC media	The specific form of object/entity where a GS1 AIDC data carrier is displayed.
AIDC media type	The code list for objects/entities (e.g., patient wristband or staff ID card) that displays or carries a GS1 AIDC data carrier.
AIDC media type value	A predefined two-digit numeric code list value used to signify the AIDC media type (e.g., ID = 10, patient wristband = 01).
AIM DotCode	A two-dimensional barcode symbology rendered by printing dots per the AIM DotCode Specification.
allocation	The association of an issued GS1 Prefix, GS1 Company Prefix, or GS1 identification key to its corresponding entity or object in accordance with the GS1 rules and policies.
alphanumeric	A character set that contains alphabetic characters (letters), numeric digits (numbers) and other characters, such as punctuation marks.
aperture	A physical opening that is part of the optical path in a device such as a scanner, photometer, or camera. Most apertures are circular, but they may be rectangular or elliptical.
Application Standard Profile	A template that records conformance requirements of existing and any future AIDC application standards, the normative decisions (MSWG, ISO, Regulation, ...), maintains centralisation of cross-application rules and related technical specifications.
asset type	A component of the Global Returnable Asset Identifier (GRAI), assigned by the asset owner or manager, in order to create a unique GRAI.
attribute	Additional information about an entity identified with a GS1 identification key.
autodiscrimination	The capability of a reader to automatically recognise and decode multiple barcode symbologies.
automatic identification and data capture (AIDC)	A technology used to automatically capture data. AIDC technologies include barcodes, smart cards, biometrics and RFID.
auxiliary patterns	Components of the EAN/UPC symbology. The centre guard bar pattern, the left guard bar pattern and the right guard bar pattern are examples of these.
bar gain/loss	The increase/decrease in bar width due to effects of the reproduction and printing processes.
barcode	A symbol that encodes data into a machine readable pattern of adjacent, varying width, parallel, rectangular or square dark and light spaces. The term barcode is inclusive of all linear and two-dimensional (2D) versions.
barcode verification	The assessment of the printed quality of a barcode based on ISO/IEC standards using ISO/IEC compliant barcode verifiers.
base unit	In a hierarchy of trade item groupings, the consumer trade item level or unit of use.
Basic Unique Device Identifier – Device Identifier (Basic UDI-DI)	The Basic UDI - DI is a unique identifier specific to a medical device family. It is represented by GS1's Global Model Number (GMN).
batch/lot	Associates an item with information the manufacturer considers relevant for traceability of the trade item.
bearer bars	Bar abutting the tops and bottoms of the bars in a barcode or a frame surrounding the entire symbol, intended to equalise the pressure exerted by the printing plate over the entire surface of the symbol and/or to prevent a partial scan by the barcode reader.
brand owner	The organisation that owns the specifications of a trade item, regardless of where and by whom it is manufactured. The brand owner is normally responsible for the management of the Global Trade Item Number (GTIN).

Term	Definition
Character Set 39	A subset of characters found in <i>ISO 646: Unique Graphic Character Allocations</i> which includes numeric, alphabetic upper-case, plus the characters "#", "-" and "/".
Character Set 64 (file-safe / URI-safe base64)	A subset of characters found in <i>ISO 646: Unique Graphic Character Allocations</i> and defined by section 5 of RFC4648 as a URI and filename safe base64 alphabet, which includes numeric, alphabetic upper-case and lower-case, plus the characters "-", "_". The "=" character is used as a special pad character and has no assigned value. The file-safe URI-safe base64 alphabet is used to represent binary data as compact alphanumeric strings, each character corresponding to a 6-bit value in the range 0-63.
Character Set 82	A subset of characters found in <i>ISO 646: Unique Graphic Character Allocations</i> which includes numeric, alphabetic upper-case and lower-case, plus twenty special characters but excluding "space".
check character pair	A final character pair calculated from the other characters of the Global Model Number. These characters are used to check that the data has been correctly composed and transmitted.
check digit	Numeric character calculated from data and appended as part of the data string to ensure that the data is correctly composed and transmitted.
codeword	A symbol character value. An intermediate level of coding between source data and the graphical encodation in the symbol.
component/part	An item that is intended to undergo at least one further transformation process to create finished goods for the purpose of downstream consumption.
Component/Part Identifier (CPID)	The unique identifier for a component/part, comprising a GS1 Company Prefix and a component/part reference.
Composite Component	The stacked linear barcode component of a GS1 composite symbol.
compound key	Two or more data elements which together serve as a key, where no subset of those data elements taken by themselves would do so (also see simple key).
concatenation	The representation of several element strings in one barcode.
Conformant	The state in which a system meets a specified standard.
consignment	A grouping of logistic or transport units assembled by a freight forwarder or carrier to be transported under one transport document (e.g., waybill).
consumer product variant (CPV)	An alphanumeric attribute of a GTIN assigned to a retail consumer trade item variant for its lifetime.
country subdivision	Principle administrative divisions, or similar areas, of a country included in <i>ISO 3166-1</i> . Examples are a state in the US, a region in France, a canton in Swiss.
coupon	A voucher that can be redeemed at the point-of-sale for a cash value or free item.
coupon issuer	Party issuing the coupons, bearing the commercial and financial responsibility for the coupons.
customer	The party that receives, buys, or consumes an item or service.
data character	A single numeric digit, alphabetic character or punctuation mark, or control character, which represents meaningful information.
data field	A field that contains a GS1 identification key, an RCN, or attribute information.
Data Matrix (GS1 Digital Link URI)	Data Matrix encoding data using the uncompressed form of GS1 Digital Link URI syntax.
Data Matrix symbology	A standalone, two-dimensional barcode symbology that is made up of square modules arranged within a perimeter finder pattern. Data Matrix using ECC 200 error correction is the only version that supports GS1 system identification keys, including the Function 1 Symbol Character (FNC1). Data Matrix symbols are read by two-dimensional imaging scanners or vision systems.
data titles	Data titles are the abbreviated descriptions of element strings which are used to support manual interpretation of barcodes.
digital coupon	A digital coupon is an electronic presentation, that is distributed and presented without manifesting as "paper" or in other hard-copy form, and that can be exchanged for a financial saving or for loyalty points when making a purchase.
Digital Signature (DigSig)	ISO/IEC 20248 defines a data construct for encoding a digital signature within a data carrier, providing a method to authenticate barcode and RFID data. It also provides a method to link the barcode and RFID data to the labelled/tagged object. The ISO/IEC 20248 data construct which contains a X.509 digital signature is known as a DigSig. "digital signature" in lower case refers to digital signatures in general, whilst "Digital Signature" with capitals, is a named thing with the specific meaning of "DigSig".

Term	Definition
digital signature	A digital signature is a compact fingerprint of data that supports tamper-detection and non-repudiation by the party who digitally signed the data. A digital signature is constructed by hashing the data then encrypting the hash using the private key. This enables independent verification by anyone, using the public key.
direct mode	Mobile device information retrieval function when the barcode contains either the address (URL) of the content or service, or the content itself, in-line.
direct part marking (DPM)	Direct part marking refers to the process of marking a symbol on an item using an intrusive or non-intrusive method.
direct print	A process in which the printing apparatus prints the symbol by making physical contact with a substrate (e.g., flexography, ink jet, dot peening).
document type	A component of a Global Document Type Identifier (GDTI) assigned by the document issuer to create a unique GDTI.
dynamic assortment	A trade item that comprises a variable composition of a fixed total count of two or more different trade items, each identified with a GTIN.
EAN/UPC symbology	A family of barcodes including EAN-8, EAN-13, UPC-A and UPC-E barcodes as well as the 2- and 5-digit add-ons. See also EAN-8 barcode, EAN-13 barcode, UPC-A barcode and UPC-E barcode.
EAN-13 barcode	A barcode of the EAN/UPC symbology that encodes GTIN-13 or RCN-13.
EAN-8 barcode	A barcode of the EAN/UPC symbology that encodes GTIN-8 or RCN-8.
economic operator (per EU 2018/574)	An economic operator is a business or other organisation which supplies goods, works or services within the context of market operations. Related to requirement for EOID for each country in which a party operates a facility.
Electronic Health Record (EHR)	Information relevant to the wellness, health and healthcare of an individual, in computer-processable form and represented according to a standardized information model. ISO 18308:2011 Health informatics — Requirements for an electronic health record architecture - https://www.iso.org/standard/52823.html
Electronic Medical Record (EMR)	A computerised system containing a collection of data and information related to the care rendered to an individual within a single healthcare organisation. EMR is often used interchangeably with EPR. Data contained within an EMR may be shared into an Electronic Health Record (EHR) as part of maintaining a complete record of care provided to an individual.
Electronic Patient Record (EPR)	A computerised system containing a collection of data and information related to the care rendered to an individual within a single healthcare organisation. EPR is often used interchangeably with EMR. Data contained within an EPR may be shared into an Electronic Health Record (EHR) as part of maintaining a complete record of care provided to an individual.
Electronic Product Code (EPC)	An identification scheme for universally identifying physical objects (e.g., trade items, assets and locations) via RFID tags and other means. The standardised EPC data consists of an EPC (or EPC Identifier) that uniquely identifies an individual object, as well as an optional filter value when judged to be necessary to enable effective and efficient reading of the EPC tags.
element	A single bar or space of a linear barcode symbol.
EU 2018/574	A European Union Regulation on the traceability of tobacco products.
EUDAMED	European database on medical devices (EUDAMED) https://ec.europa.eu/health/medical-devices-eudamed/overview_en
even parity	A characteristic of the encodation of a symbol character whereby the symbol character contains an even number of dark modules.
extended packaging	An approach to giving consumers access to additional information or services about trade items through their mobile device. It is the ability to retrieve additional information about the trade item through mobile devices or, in general, to link a trade item with trusted virtual information or services.
extension digit	The first digit within the Serial Shipping Container Code (SSCC) which is assigned by the company that constructs the logistic unit.
facility (per EU 2018/574)	Any location, building or vending machine where tobacco products are manufactured, stored or placed on the market.
fixed length	Term used to describe a data field in an element string with an established number of characters.

Term	Definition
fixed measure trade item	An item always produced in the same predefined version (e.g., type, size, weight, contents, design) that may be sold at any point in the supply chain.
freight forwarder	The party that arranges the carriage of goods including connected services and/or associated formalities on behalf of the shipper (consignor) or consignee.
fresh foods	Trade items in the following product categories: fruits, vegetables, meats, seafood, bakery and ready to serve food such as cheeses, cold cooked or cured meats and salad, etc. Fresh foods are defined as food that is not preserved by canning, dehydration, freezing or smoking.
full string	The data transmitted by the barcode reader from reading a data carrier, including the symbology identifier as well as the encoded data.
Function 1 Symbol Character (FNC1)	A symbology character used in some GS1 data carriers for specific purposes.
general distribution scanning	Scanning environments that process barcoded trade items packaged for transport, logistic units, assets and location tags.
general retail consumer trade item	A trade item intended to be sold at retail point-of-sale identified with a GTIN-13, GTIN-12 or GTIN-8 utilising omnidirectional linear barcodes.
general retail products	All trade items that cross point-of-sale.
GLN extension component	The GLN extension component is used to identify internal physical sub-locations within a location (such as a selling floor area, a specific area on a shelf, etc.) which is identified with a GLN (such as stores, factories, buildings, etc.).
Global Coupon Number (GCN)	The GS1 identification key used to identify a coupon. The key comprises a GS1 Company Prefix, coupon reference, check digit and an optional serial number.
Global Document Type Identifier (GDTI)	The GS1 identification key used to identify a document type. The key comprises a GS1 Company Prefix, document type, check digit and optional serial number.
Global Identification Number for Consignment (GINC)	The GS1 identification key used to identify a logical grouping of logistic or transport units that are assembled to be transported under one transport document (e.g., waybill). The key comprises a GS1 Company Prefix and the freight forwarder's or carrier's transport reference.
Global Individual Asset Identifier (GIAI)	The GS1 identification key used to identify an individual asset. The key comprises a GS1 Company Prefix and individual asset reference.
Global Location Number (GLN)	The GS1 identification key used to identify locations or parties. The key comprises a GS1 Company Prefix, location reference and check digit.
Global Model Number (GMN)	The GS1 identification key used to identify a product model or product family. The key comprises a GS1 Company Prefix, model reference and a check character pair.
Global Returnable Asset Identifier (GRAI)	The GS1 identification key used to identify returnable assets. The key comprises a GS1 Company Prefix, asset type, check digit and optional serial number.
Global Service Relation Number (GSRN)	The GS1 identification key used to identify the relationship between an organisation offering services and the recipient or provider of services. The key comprises a GS1 Company Prefix, service reference and check digit.
Global Shipment Identification Number (GSIN)	The GS1 identification key used to identify a logical grouping of logistic or transport units that are assembled by the consignor (seller) for a transport shipment from that consignor to one consignee (buyer) referencing a despatch advice and/or BOL. The key comprises a GS1 Company Prefix, shipper reference and check digit.
Global Trade Item Number® (GTIN®)	The GS1 identification key used to identify trade items. The key comprises a GS1 Company Prefix, an item reference and check digit.
GS1 Application Identifier (AI)	The field of two or more digits at the beginning of an element string that uniquely defines its format and meaning.
GS1 Application Identifier data field	The data used in a business application defined by one GS1 Application Identifier.
GS1 check character calculation	An algorithm used by the GS1 system for the calculation of the check characters to verify accuracy of data.
GS1 check digit calculation	An algorithm used by the GS1 system for the calculation of a check digit to verify accuracy of data. (e.g., modulo 10 check digit, price check digit).
GS1 Common Currency Coupon Code	An identification number for coupons issued in a common currency area (e.g., the euro currency) that uses the GS1 Prefixes 981-983.

Term	Definition
GS1 Company Prefix (GCP)	A unique string of four to twelve digits used to issue GS1 identification keys. The first digits are a valid GS1 Prefix. the length of the GS1 Company Prefix must be at least one longer than the length of the GS1 Prefix. The GS1 Company Prefix is issued by a GS1 Member Organisation. As the GS1 Company Prefix varies in length, the issuance of a GS1 Company Prefix excludes all longer strings that start with the same digits from being issued as GS1 Company Prefixes. See also U.P.C Company Prefix.
GS1 Composite symbology	A GS1 system composite symbol consists of a linear component (encoding the item's primary identification) associated with an adjacent Composite Component (encoding attribute data, such as a batch number or expiration date). The composite symbol always includes a linear component so that the primary identification is readable by all scanning technologies, and so that imager scanners can use the linear component as a finder pattern for the adjacent 2D Composite Component. The composite symbol always includes one of three multi-row 2D Composite Component versions (e.g., CC-A, CC-B, CC-C) for compatibility with linear- and area-CCD scanners and with linear and rastering laser scanners.
GS1 conformant barcode	A family of symbols comprising all barcodes in accordance with an application standard, the data carrier specifications and relevant GS1 symbol specification table.
GS1 DataBar Composite symbology family	A family of symbols comprising all the GS1 DataBar barcodes when an accompanying Composite Component is printed directly above the linear component.
GS1 DataBar Expanded barcode	A barcode that encodes any GS1 identification key plus attribute data, such as weight and "best before" date, in a linear symbol that can be scanned omnidirectionally by suitably programmed point-of-sale scanners.
GS1 DataBar Expanded Stacked barcode	A barcode that is a variation of the GS1 DataBar Expanded barcode that is stacked in multiple rows and is used when the normal symbol would be too wide for the application.
GS1 DataBar Limited barcode	A barcode that encodes a GTIN with a leading digit of zero or indicator digit of one in a linear symbol; for use on small items that will not be scanned at the point-of-sale.
GS1 DataBar Omnidirectional barcode	A barcode that encodes a GTIN. It is designed to be read by omnidirectional scanners.
GS1 DataBar Retail POS family	The members of the GS1 DataBar symbology family designed to be read in segments by omnidirectional scanners at retail POS: GS1 DataBar Omnidirectional; GS1 DataBar Stacked Omnidirectional; GS1 DataBar Expanded; GS1 DataBar Expanded Stacked.
GS1 DataBar Stacked barcode	A barcode that is a variation of the GS1 DataBar Truncated barcode that is stacked in two rows and is used when the GS1 DataBar Truncated barcode would be too wide for the application.
GS1 DataBar Stacked Omnidirectional barcode	A barcode that is a variation of the GS1 DataBar symbology that is stacked in two rows and is used when the GS1 DataBar Omnidirectional symbol would be too wide for the application. It is designed to be read by omnidirectional checkout scanners.
GS1 DataBar Truncated barcode	A barcode that is a truncated version of the GS1 DataBar Omnidirectional barcode. It is used when the GS1 DataBar Omnidirectional barcode would be too tall for small item marking applications. It is not intended for omnidirectional checkout scanning.
GS1 DataBar®	A family of barcodes, including GS1 DataBar Omnidirectional; GS1 DataBar Stacked Omnidirectional; GS1 DataBar Expanded; GS1 DataBar Expanded Stacked GS1 DataBar Truncated, GS1 DataBar Limited and GS1 DataBar Stacked symbols.
GS1 DataMatrix	A subset of Data Matrix which uses the function that allows the encoding of element strings.
GS1 Digital Link URI	A Web URI syntax for expressing GS1 identifier keys and attributes in a format using GS1 Application Identifiers and GS1 Application Identifier data fields as specified in the GS1 Digital Link standard.
GS1 DotCode	A subset of AIM DotCode which uses the function that allows the encoding of element strings.
GS1 EANCOM®	The GS1 standard for Electronic Data Interchange (EDI) that is a detailed implementation guideline of the UN/EDIFACT standard messages using the GS1 identification keys.
GS1 element string	A syntax for expressing GS1 identifier keys and attributes in a format using GS1 Application Identifiers and GS1 Application Identifier data fields.
GS1 Global Office (GS1 GO)	GS1 is a neutral, not-for-profit organisation that provides global standards for efficient business communication. The Global Office, located in Brussels (Belgium) and Ewing, NJ (USA) is the guardian, and provides an open, user-driven, forum for ongoing maintenance and development, of the GS1 standards, guidelines and statues.
GS1 Global Standards Management Process (GSMP)	GS1 created the Global Standards Management Process (GSMP) to support standards development activity for the GS1 system. The GSMP uses a global consensus process to develop supply chain standards that are based on business needs and user-input.

Term	Definition
GS1 identification key	A unique identifier for a class of objects (e.g., a trade item) or an instance of an object (e.g., a logistic unit).
GS1 identification licensee	The person (natural or legal) to which the right to use a GS1 Company Prefix or a GS1 identification key has been granted through an agreement with a GS1 Member Organisation or GS1 Global Office, acting as licensor. GS1 identification licensees may use the licensed GS1 Company Prefix or GS1 identification key, subject to any terms and conditions in place when the licence was granted or set by the licensor from time to time, until such time as the agreement under which the licence was granted expires or in perpetuity if the agreement has no expiration date.
GS1 Member Organisation (GS1 MO)	A member of GS1 that is responsible for administering the GS1 system in its country (or assigned area). This task includes, but is not restricted to, ensuring user companies make correct use of the GS1 system, have access to education, training, promotion and implementation support and have access to play an active role in GSMP.
GS1 Prefix	A unique string of two or more digits issued by GS1 Global Office and allocated to GS1 Member Organisations to issue GS1 Company Prefixes or allocated to other specific areas.
GS1 QR Code	A subset of QR Code which uses the function that allows the encoding of element strings.
GS1 symbologies using GS1 Application Identifiers	All GS1 endorsed barcode symbologies that can encode more than a GTIN namely GS1-128, GS1 DataMatrix, GS1 DataBar, GS1 QR Code, GS1 DotCode and GS1Composite.
GS1 syntax	A data structure used within the GS1 system of standards for representing data elements. GS1 syntax includes plain syntax, GS1 element string, GS1 Digital Link URI, and Electronic Product Code (EPC) URI.
GS1 system	The specifications, standards and guidelines administered by GS1.
GS1 UIC Extension 1	Character that follows and extends the EU 2018/574 UIC to identify a country of ID Issuer's appointment and operation.
GS1 UIC Extension 2	Character that follows GS1 UIC Extension 1 and extends the EU 2018/574 UIC to identify whether a GS1 or non-GS1 based algorithm is used.
GS1 XML	The GS1 standard for extensible markup language (XML) schemas providing users with a global business messaging language of e-business to conduct efficient internet-based commerce.
GS1®	Based in Brussels, Belgium and Princeton, USA, it is the organisation that manages the GS1 system. Its members are GS1 Member Organisations.
GS1-128 symbology	A subset of Code 128 which uses the function that allows the encoding of element strings.
GS1-8 Prefix	A unique string of two or more digits issued by GS1 Global Office and allocated to GS1 Member Organisations to issue GTIN-8s or allocated to issue RCN-8s (see RCN-8).
GTIN allocator	The party that warrants the trade item declarations about a trade item to which they allocate a GTIN. This is the party who is the licensee of the GTIN applied to a specific trade item.
GTIN plus attribute(s) flag	A trigger in systems to determine if additional processing is required by a barcode user for a given GTIN.
GTIN-12	The 12-digit GS1 identification key composed of a U.P.C. Company Prefix, item reference and check digit used to identify trade items.
GTIN-13	The 13-digit GS1 identification key composed of a GS1 Company Prefix, item reference and check digit used to identify trade items.
GTIN-14	The 14-digit GS1 identification key composed of an indicator digit (1-9), GS1 Company Prefix, item reference and check digit used to identify trade items.
GTIN-8	The 8-digit GS1 identification key composed of a GS1-8 Prefix, item reference and check digit used to identify trade items.
guard bar pattern	An auxiliary pattern of bars and spaces corresponding to start or stop patterns in barcode symbologies, and serving to separate the two halves of EAN-8, EAN-13 and UPC-A symbols.
healthcare primary packaging	The first level of packaging for the product marked with an AIDC data carrier either on the packaging or on a label affixed to the packaging. For non-sterile packaging, the first level of packaging can be the packaging in direct contact with the product. For sterile packaging, the first level of packaging can be any combination of the sterile packaging system, May consist of a single item or group of items for a single therapy such as a kit. For packaging configurations that include a retail consumer trade item, primary packaging is a packaging level below the retail consumer trade item.

Term	Definition
healthcare provider	An organisation or facility that delivers healthcare to a subject of care. Corresponds to “care delivery organisation”, “healthcare organisation”, etc.
healthcare secondary packaging	A level of packaging marked with an AIDC carrier that may contain one or more primary packages each of which may contain a single item or multiple items.
Highly Individualised Device (per EU MDR)	Device subject to EUDAMED registration via MUDI-DI as UDI-DI
Highly Individualised Device Registration Identifier (HIDRI)	A special version of the Global Model Number that identifies a group of highly individualised medical devices within EUDAMED.
House Waybill Number	A freight forwarder’s document used mainly as a control for the goods within the freight forwarder’s own service system.
human readable interpretation (HRI)	Characters, such as letters and numbers, which can be read by persons and are encoded in GS1 AIDC data carriers confined to a GS1 standard structure and format. The human readable interpretation is the encoded data. Start, stop, shift and function characters, as well as the symbol check character, are not shown in the human readable interpretation.
human readable text	Refers to HRI and/or non-HRI text collectively, when referencing data that is encoded into a data carrier.
Importer index (per EU 2018/574)	Character to identify the presence or absence of an importer within the EU 2018/574 EOID, FID and MID. This means either the absence of an importer (null) or presence of one importer out of up to 63 importer possibilities per country, per GTIN.
indicator	A digit from 1 to 9 in the leftmost position of the GTIN-14.
indirect mode	Mobile device information retrieval function when the code contains an identifier, which needs to be resolved to obtain the content or service. Resolving an identifier means looking it up, typically at a network service, to determine the corresponding content or service.
individual asset	An object that is part of the inventory of assets for a given company. (See also returnable asset.)
individual asset reference	A component of the Global Individual Asset Identifier (GIAI) assigned by the asset owner or manager to create a unique GIAI.
individual provider	Any person who provides or is a potential provider of a health care service to a subject of care.
Interleaved 2-of-5 symbology	Barcode symbology used for the ITF-14 barcode.
inverse exponent	The GS1 Application Identifier digit that denotes the implied decimal point position in an element string.
issuance	The generation of a GS1 Prefix, GS1 Company Prefix, or GS1 identification key in accordance with GS1 rules and policies by GS1 or a GS1 Member Organisation.
item reference	A component of the Global Trade Item Number (GTIN) assigned by the brand owner to create a unique GTIN.
ITF-14 barcode	ITF-14 (a subset of Interleaved 2-of-5) barcodes carry GTINs only on trade items that are not expected to pass through the point-of-sale.
kit	A collection of different regulated healthcare items assembled for use in a single therapy.
leading zero(es)	Adding zeroes in the leftmost position(s) of a data string when GTIN-8, GTIN-12, or GTIN-13 are encoded in an GS1 AIDC data carrier, message, or database that requires 14-digits or when used for the same intent in other data structures such as GRAI.
levels of AIDC marking	A graduated system of AIDC marking. The graduated system is defined as minimum, enhanced and highest levels of AIDC marking.
linear barcode	Barcode symbology using bars and spaces in one dimension.
local assigned code (LAC)	A particular use of the UPC-E barcode for restricted distribution.
location reference	A component of a Global Location Number (GLN) that allows the party defining the party or location to create a unique GLN.
logistic measures	Measures indicating the outside dimensions, total weight, or volume inclusive of packing material of a logistic unit. Also known as gross measures.
logistic unit	An item of any composition established for transport and/or storage that needs to be managed through the supply chain. It is identified with a Serial Shipping Container Code (SSCC).

Term	Definition
Made-to-Order (MtO) trade item	A bespoke (e.g., customised, personalised, configurable) product or service where the GTIN, allocated per application specific rules rather than the GTIN Management Standard, plus a compound key data element (Made-to-Order variant, lot number, serial number) is required to distinguish whenever any of the trade item declarations are different in any way that is relevant to the trading process.
Made-to-Stock (MtS) trade item	A product or service where a separate, unique GTIN, allocated per the GTIN Management Standard, is required to distinguish whenever any of the trade item declarations are different in any way that is relevant to the trading process.
main symbol	The barcode containing the identification number of the item (e.g., GTIN, SSCC). Used to determine the placement of any additional barcode information.
Master Unique Device Identifier – Device Identifier (MUDI-DI)	The Master UDI-DI is a unique identifier specific to a family of highly individualised medical devices for the restricted use of EUDAMED registration.
measure verifier digit	A digit calculated from the measure field in a Restricted Circulation Number (RCN) that is used to check that the data has been correctly composed.
Medical device family	A group of medical devices manufactured by or for the same organization and have the same basic design and performance characteristics related to safety, intended use and function.* * SOURCE: ISO 13485- Medical devices - Quality management systems – Requirements for regulatory purposes.
merchant	The party that makes a trade item available for sale. A retailer is one type of merchant. An online seller is another type of merchant.
model reference	A component of the Global Model Number (GMN) assigned by the brand owner to create a unique GMN.
module	The narrowest nominal width unit of measure in a barcode. In certain symbologies, element widths may be specified as multiples of one module. The nominal width (& height for 2D barcodes) of a single module is equivalent to the X-dimension.
modulo 10	The name of the algorithm – a simple checksum formula in the public domain – used to create a check digit for those GS1 identification keys that require one.
multiple unit blister/package	Immediate package for a medicine with more than one single unit. Package which fully encloses the pill/caplet/capsule. Each dosage form may be individually packaged. The individually blistered dosage forms are attached to each other in one strip.
National Healthcare Reimbursement Number (NHRN)	National and/or regional identification numbers used on pharmaceutical and/or medical devices where required by national or regional regulatory organisations for product registration purposes and/or for the management of healthcare provider reimbursement.
National Trade Item Number (NTIN)	A coding scheme, administered in the healthcare sector by a national organisation for which a GS1 Prefix has been issued to permit its uniqueness within the GTIN pool but without assurance of full compatibility with GTIN functionality. The result is a product identification number assigned by a third party (not the brand owner or manufacturer). Example: the CIP (Club Inter Pharmaceutique) in France administered by the French Health Products Safety Agency (AFSSAPS).
non-human readable interpretation text (non-HRI)	Characters such as letters and numbers that can be read by persons and may or may not be encoded in GS1 AIDC data carriers and are not confined to a structure and format based on GS1 standards (e.g., a date code expressed in a national format that could be used to encode a date field in a GS1 AIDC data carrier, brand owner name, consumer declarations).
odd parity	A characteristic of the encodation of a symbol character whereby the symbol character contains an odd number of dark modules.
offer declarations	The set of all information declared (or agreed to) by the seller about the trade item (inclusive of price, availability, terms of sale, claims, condition, shipping information, returns information, etc).
omnidirectional linear barcode	A linear barcode symbology designed to be read in segments by suitably programmed laser point-of-sale (POS) scanners.
packaging component	Objects such as bottles, caps and labels to package a consumer trade item.
packaging component number	Global Trade Item Number (GTIN) attribute used to establish a relationship between a finished consumer trade item and packaging components.
payment slip	The end customer's notification of a demand for payment for a billable service (e.g., utility bill) comprising an amount payable and payment conditions.

Term	Definition
physical trade item assortment/bundle	A combination of different trade items that are physically combined into a single trade item, thus creating a new trade item.
plain syntax	GS1 data structure containing GS1 identification key with no additional characters or syntactic features.
point-of-care (POC)	Location where dispensing or use of a non-retail, regulated healthcare pharmaceutical or medical device to or for a patient occurs.
point-of-sale (POS)	Refers to the retail checkout where omnidirectional linear barcodes must be used to support high-volume laser-based scanning or low volume checkout where linear barcodes (or for regulated healthcare trade items, GS1 DataMatrix) are used with image-based scanners.
predefined assortments	A trade item that comprises a fixed composition of two or more different trade items, each identified with a GTIN.
price verifier digit	A digit calculated from the price element in a Restricted Circulation Number (RCN) that is used to check that the data has been correctly composed.
product model	A base product design or specification from which a trade item is derived.
QR Code (GS1 Digital Link URI)	QR Code encoding data using the uncompressed form of GS1 Digital Link URI syntax.
QR Code symbology	A two-dimensional barcode symbology consisting of square modules arranged in a square pattern. The symbology is characterised by a unique finder pattern located at three corners of the symbol. QR Code symbols are read by two-dimensional imaging scanners or vision systems.
Quiet Zone	A clear space which precedes the start character and follows the stop character of a linear barcode or surrounds a 2D barcode.
Quiet Zone Indicator	A greater than (>) or less than (<) character, printed in the human readable field of the barcode, with the tip aligned with the outer edge of the Quiet Zone.
radio frequency	Any frequency within the electromagnetic spectrum associated with radio wave propagation. When radio frequency power is supplied to an antenna, an electromagnetic field is created that then is able to propagate through space. A radio frequency signal that can be processed by a radio frequency receiver. Many wireless technologies are based on radio frequency field propagation.
radio frequency identification (RFID)	A technology that uses radio frequency electromagnetic fields or waves to automatically identify and track tags attached to objects. An RFID system consists of RFID tags and readers. When triggered by a radio frequency electromagnetic interrogation signal from a nearby RFID reader, the RFID tag transmits digital data, usually a unique identifier like an EPC, back to the reader.
RCN-12	A 12-digit Restricted Circulation Number (see Restricted Circulation Number).
RCN-13	A 13-digit Restricted Circulation Number (see Restricted Circulation Number).
RCN-8	An 8-digit Restricted Circulation Number (see Restricted Circulation Number)
refund receipt	A voucher produced by equipment handling empty containers (i.e., bottles and crates).
regular expression	A sequence of characters that specifies a search pattern that is usually used by string-searching algorithms for search / find-and-replace operations on strings or for validation of string input.
regulated healthcare non-retail consumer trade item	A regulated healthcare trade item not intended for scanning at POS and identified with a GTIN-14, GTIN-13, GTIN-12 or GTIN-8 utilising linear or 2D barcodes that can be scanned by image-based scanners.
regulated healthcare retail consumer trade item	A regulated healthcare trade item to be sold to the end consumers at a regulated healthcare retail point-of-sale (i.e., pharmacies). They are identified with a GTIN-13, GTIN-12 or GTIN-8 utilising linear or GS1 DataMatrix barcodes that can be scanned by image-based scanners.
regulated healthcare trade item	Pharmaceuticals or medical devices that are sold or dispensed in a controlled environment (e.g., retail pharmacy, hospital pharmacy).
responsible entity	The party responsible for the safety and effectiveness of the medical product at a moment in time in its life cycle, according to the approved regulatory file (including labelling) and regulatory/legal/professional obligations associated with the medical product. (e.g., brand owner, repackager, hospital pharmacy, etc.)
Restricted Circulation Number (RCN)	Signifies an identification number used for special applications in restricted environments, either defined by local GS1 Member Organisations (for regional applications such as variable measure product identification and, couponing) or by a company (for internal applications).

Term	Definition
retail consumer trade item variant	A variation of change to a retail consumer trade item (which may itself be a homogeneous or predefined assortment of other retail consumer trade items) which does not require a new GTIN, but where identification of the variation may be required.
returnable asset	A reusable entity owned by a company that is used for transport and storage of goods. It is identified with a GRAI.
separator character	Special character(s) that are defined as part of GS1 symbologies and used to separate concatenated element strings, based on their positioning in the GS1 barcodes.
serial number	A code, numeric or alphanumeric, assigned to an individual instance of an entity for its lifetime. Example: a unique individual item may be identified with the combined Global Trade Item Number (GTIN) and serial number.
serial reference	A component of the Serial Shipping Container Code (SSCC) assigned by the physical builder or brand owner of the logistic unit to create a unique SSCC.
Serial Shipping Container Code (SSCC)	The GS1 identification key used to identify logistics units. The key comprises an extension digit, GS1 Company Prefix, serial reference and check digit.
service reference	A component of the Global Service Relation Number (GSRN) assigned by the issuing organisation to create a unique GSRN.
service relation instance number (SRIN)	An attribute to the GSRN which allows to distinguish different encounters during a service relationship.
shipment	A grouping of logistic and transport units assembled and identified by the seller (sender) of the goods travelling under one despatch advice and/or Bill of Lading to one customer (recipient).
short life items	An item, preparation or reconstituted product with limited use/shelf life.
simple key	A single data element that serves as a key (also see compound key).
single unit package/blister	A healthcare primary package that contains one discrete pharmaceutical dosage form, i.e. a tablet, a certain volume of a liquid or that is the immediate package for a medical device like a syringe. A number of single units attached to each other, but are easily separated through a perforation would be included.
standard contact lenses (per EU MDR)	A type of highly individualised device, (typically made-to-stock and identified by GTIN for trade purposes), registered in EUDAMED per European Medical Device Regulations (MDR)
sterile packaging system	A combination of the sterile barrier system (the minimum package that prevents ingress of microorganisms and allows aseptic presentation of the product at the point of use) and the protective packaging (configuration of materials designed to prevent damage to the sterile barrier system and its contents until the point of use).
subject of care	Any person who uses or is a potential user of a healthcare service, subjects of care may also be referred to as patients or healthcare consumers.
substrate	The material on which a barcode is printed or otherwise applied.
Supplemental symbol	A GS1-128 barcode used in combination with EAN/UPC, ITF-14 or GS1-128 where additional information is required beyond the barcode that carries the GS1 key (main symbol).
supplier	The party that produces, provides, or furnishes an item or service.
symbol character	A group of bars and spaces in a symbol that is decoded as a single unit. It may represent an individual digit, letter, punctuation mark, control indicator, or multiple data characters (see also codeword).
symbol check character	A symbol character or set of bar/space patterns included within a GS1-128 or GS1 DataBar symbol, the value of which is used by the barcode reader for the purpose of performing a mathematical check to ensure the accuracy of the scanned data. It is not shown in human readable interpretation. It is not input to the barcode printer and is not transmitted by the barcode reader.
symbol contrast	An <i>ISO/IEC 15416</i> parameter that measures the difference between the largest and smallest reflectance values in a Scan Reflectance Profile (SRP).
symbology	A defined method of representing numeric or alphabetic characters in a barcode; a type of barcode.
symbology identifier	A sequence of characters generated by the decoder (and prefixed to the decoded data transmitted by the decoder) that identifies the symbology from which the data has been decoded.
trade item	Any item (product or service) upon which there is a need to retrieve predefined information and that may be priced, or ordered, or invoiced at any point in any supply chain.

Term	Definition
trade item declarations	The set of all information about a trade item (e.g., manufacturer warranty, ingredients, instructions for use, specifications, contents, certifications, predefined characteristics, and other information). For a trade item, this is all of the information that is on the label and in the original packaging. It also includes relevant aspects of the extended packaging.
trade item grouping	A predefined composition of trade item(s) that is not intended for point-of-sale scanning. It is identified with a GTIN-14, GTIN-13, or GTIN-12.
trade measures	Net measures of variable measure trade items as used for invoicing (billing) the trade item.
transport process information	A set of information relevant to the processing, delivery or return of a transport unit. For example, transport process information would include address details.
transport unit	A logistic unit within the context of transport processes.
truncation	Printing a symbol shorter than the symbology specification's minimum height recommendations. Truncation can make the symbol difficult for an operator to scan.
two-dimensional (2D) barcode symbology	Optically readable symbols that must be examined both vertically and horizontally to read the entire message. 2D barcodes may be one of two types: matrix symbols and multi-row symbols. 2D barcodes have error detection and may include error correction features.
U.P.C. Company Prefix	A GS1 Company Prefix starting with a zero ('0') becomes a U.P.C. Company Prefix by removing the leading zero. A U.P.C. Company Prefix is used to issue and allocate GTIN-12.
U.P.C. Prefix	A GS1 Prefix starting with a zero ('0') becomes a U.P.C. Prefix by removing the leading zero. A U.P.C. Prefix is used to issue U.P.C. Company Prefixes or allocated to other specific areas.
Unique Device Identifier – Device Identifier (UDI-DI)	A unique identifier specific to a medical device trade item represented by a Global Trade Item Number (GTIN).
Unique Device Identifier – Production Identifier (UDI-PI)	A numeric or alphanumeric code that identifies the unit of device production. The different types of UDI-PIs include serial number, lot number, software identification and manufacturing or expiry date or both types of date.
Unique Device Identifier (UDI)	A series of numeric or alphanumeric characters that is created through a globally accepted device identification and coding standard. It allows the unambiguous identification of a specific medical device on the market. The UDI is comprised of the UDI-DI and the UDI-PI. The word 'Unique' does not imply serialisation of individual production units.
Unique Identification Code (UIC) (per EU 2018/574)	Identifier of an EU 2018/574 ID Issuer that begins with an ISO 15459 Issuing Agency Code.
unit of use	Refers to an individual unit package that is prescribed for or administered to a patient regardless whether it is packaged individually or, on the contrary, the smallest package contains more than one unit. May coincide with the single unit and the base unit.
Unit of Use UDI-DI (UoU UDI-DI)	Device identifier for the unit of use, meant to associate the use of a device with a patient. In cases where the unit of use coincides with another packaging level, that level's device identifier functions as a UoU UDI-DI, otherwise a separate device identifier has to be allocated. For example, three clips (which do not carry a physical UDI marking themselves) are contained in a cartridge which is packaged inside a container, which does carry a labelled UDI.
UPC-A barcode	A barcode of the EAN/UPC symbology that encodes GTIN-12 and RCN-12.
UPC-E barcode	A barcode of the EAN/UPC symbology representing a GTIN-12 in six explicitly encoded digits using zero-suppression.
variable measure trade item	A trade item which may be traded without a predefined measure, such as its weight or length.
version control	The management of different versions of the same entity.
Version Control Number (VCN)	A GS1 identification key attribute to facilitate version control, where differentiation is required for multiple occurrences of the same identification used on the same AIDC media type. For example, to ensure only the latest occurrence of access controlled AIDC media is valid upon scanning, where multiple occurrences could present risks (e.g., lost ID badge).
virtual trade item assortment/bundle	Combinations of multiple (same or different) trade items that are not physically combined into a single trade item, but that are presented in selling environments as offers of combinations of multiple trade items (e.g., products or services).
warranty	A guarantee or claim that a party makes.

Term	Definition
wide-to-narrow ratio	The ratio between the wide elements and the narrow elements in a barcode symbology such as ITF-14 that has two different element widths.
X-dimension	The specified width of the narrowest element of a barcode (see module).

9.2 Legacy (retired) terms

When terms are replaced or retired by GS1, they are maintained within this section for a minimum of five years. The legacy terms are supplied to point GS1 stakeholders to new terminology. The period of five years ensures harmonisation with external standards bodies whose standards make normative reference to the *GS1 General Specifications*.

Legacy term	Current term
Coupon-12	See RCN-12
Coupon-13	See RCN-13
GCTIN	ITIP
Interleaved 2 of 5	ITF-14 Symbol
Magnification	See X-dimension
Number System Character	See U.P.C. Prefix
print gain/loss	bar gain/loss
Reduced Space Symbology (RSS)	GS1 DataBar Symbology
SCC-14	Global Trade Item Number
Symbol Control Character	symbology element
variable measure number (VMN)	See restricted circulation number (RCN)
VMN-12	See RCN-12
VMN-13	See RCN-13

9.3 GS1 abbreviations

Abbreviation	Term
ADC	Automatic Data Capture
AI	GS1 Application Identifier
AIDC	Automatic Identification and Data Capture
ASP	Application Standard Profile
aUI	aggregate Unique Identifier (per EU 2018/574)
BUDI-DI	Basic UDI - Device Identifier
DPM	Direct Part Marking
DL	GS1 Digital Link
EAN	EAN International, now called GS1
EDI	Electronic Data Interchange
EHR	Electronic Health Record
EMR	Electronic Medical Record
EOID	Economic Operator Identifier (per EU 2018/574)
EPC	Electronic Product Code
EPR	Electronic Patient Record
EU	European Union
FID	Facility Identifier (per EU 2018/574)
FNC1	Function 1 Symbol Character
GCN	Global Coupon Number
GCP	GS1 Company Prefix

Abbreviation	Term
GDSN	Global Data Synchronisation Network
GDTI	Global Document Type Identifier
GIAI	Global Individual Asset Identifier
GINC	Global Identification Number for Consignment
GLN	Global Location Number
GMN	Global Model Number
GRAI	Global Returnable Asset Identifier
GRCTI	General Retail Consumer Trade Item
GS1 DL URI	GS1 Digital Link Uniform Resource Identifier
GS1 key	GS1 identification key
GSIN	Global Shipment Identification Number
GSMP	Global Standards Management Process
GSRN	Global Service Relation Number
GS1 UIC EXT	GS1 UIC Extension
GTIN	Global Trade Item Number
HIDRI	Highly Individualised Device Registration Identifier
HRI	Human Readable Interpretation
ISBN	International Standard Book Number
ISO	International Organization for Standardization
ISSN	International Standard Serial Number
ITIP	Identification of Trade Item Pieces
LAC	Local Assigned Code
MtO	Made-to-Order
MtS	Made-to-Stock
NHRN	National Healthcare Reimbursement Number
NTIN	National Trade Item Number
RCN	Restricted Circulation Number
RFID	Radio Frequency Identification
RHTI	Regulated healthcare trade item
RSS	Reduced Space Symbology
SKU	Stock Keeping Unit
SRIN	Service Relation Instance Number
SSCC	Serial Shipping Container Code
TPX	Third Party Controlled, Serialised Extension of GTIN (restricted to EU 2018/574 regulatory use)
UIC	Unique Identification Code (per EU 2018/574)
upUI	unit pack Unique Identifier (per EU 2018/574)
UDI	Unique Device Identifier
UDI-DI	Unique Device Identifier – Device Identifier
UDI-PI	Unique Device Identifier – Production Identifier
UoM	Unit of Measure
UoU	Unit of Use
VCN	Version Control Number