



The Global Language of Business

GDSN Trade Item Implementation Guideline

Supplements the formal GS1 Global Data Synchronisation Network (GDSN) standards with advice on their implementation and operation

Release 37, Ratified, Mar 2024

Document Summary

Document Item	Current Value
Document Name	GDSN Trade Item Implementation Guideline
Document Date	Mar 2024
Document Version	37
Document Issue	
Document Status	Ratified
Document Description	Supplements the formal GS1 Global Data Synchronisation Network (GDSN) standards with advice on their implementation and operation

Related Documents

The following documents provide additional background and relevant information:

1. **GDSN Trade Item for Data Alignment BMS:** Standards document for GDSN Trade Item for Data Alignment. It contains business rules, attributes, and class diagrams – <https://www.gs1.org/standards/gdsn>
2. **Catalogue Item Synchronisation BMS:** Standards document for GDSN Catalogue Item Synchronisation. It contains detailed use-cases of the GDSN message choreography – <https://www.gs1.org/standards/gdsn>
3. **GS1 XML Release Technical User Guide:** The technical guidelines to the structure and design of the GS1 XML – <https://www.gs1.org/edi-xml/latest>
4. **GDSN XML Operations Manual:** The user operations manual for the GDSN – <https://www.gs1.org/standards/gdsn>
5. **GS1 Navigator, GDSN:** A repository of core component with business definitions and syntax – <https://navigator.gs1.org/gdsn/quick-search>
6. **GDSN Validation Rules:** Distributed Global Validation Rules required to support the Global Data Synchronisation process – <https://www.gs1.org/standards/gdsn>
7. **GS1 General Specifications:** The core standards document of the GS1 system describing how GS1 barcodes and identification keys should be used. – <https://www.gs1.org/genspecs>
8. **GTIN Management Standard:** Provides the global supply chain solution for the identification of any item that is traded (priced, ordered, invoiced) – <https://www.gs1.org/1/gtinrules>

Log of Changes

Release	Date of Change	Changed By	Summary of Change
Issue 1	Jan-2006	N/A	1st Issue
Issue 2	May-2007	M. Mowad D. Yeksigian	Section 4. Trade Item Unit Descriptors – updated the important note about CR # 07-000017 Added section 7. Variable Measure Products (Non-Food) Added section 8. Metric and Imperial Measurements
Issue 3	Jun-2007	R. Kidd	Added section 9. Net Weight Added “Net Weight” to the Glossary
Issue 4	Jun-2007	L. Della Mora	Added section 10 Trade Item Country of Origin
Issue 5	Feb-2008	D. Mouthaan G. Sobrino	Added section 24. Fresh Foods

Release	Date of Change	Changed By	Summary of Change
Issue 6	Mar-2008	R. Kidd M. Mowad	Added section 11. Item Futurisation Changed all references to GDSN BMS from 2.1 to 2.2
Issue 7	May-2008	N. Radomski	Added Section 12. Broker/Distributor Model
Issue 8	Oct-2008	M. Mowad G. Piacenza J. Schneck B. Windsperger	Updated all Graphics Replace sections 2.1 and 2.2 with new section 2.1: What is GDSN? Added Section 3.11, CIC Response to CIN
Issue 9	Feb-2009	M. Mowad R. Kidd G. Sobrino D. Yeksigian	Updated the "Reference Documents" section Updated section 11. Item Futurisation - removed replacedTradeitem related information from sections 11.2.2, 11.4, 11.6.1, 11.6.2, 11.6.3, 11.6.4, 11.6.5, 11.8.1, 11.8.4, 11.11.1, 11.11.2, - Removed section 11.11.4 Updated section 24. Fresh Foods - Removed "Fast Moving Consumer Goods" from section 4.2 - Updated first paragraph in section 17.3.2.3. Generic Products (non-branded items) - Updated first paragraph in section 17.3.3.2, 17.3.3.3, and 17.3.3.4 Updated second paragraph in 17.3.3.5 Updated section 5.3.2 (Populating TI/HI) with a new note on Pallet Type Codes
Issue 10	April-2009	R. Kidd R. Kidd M. Mowad R. Kidd	Added section 14. Display Space Planning Added section 15. Extended Attributes Errata change to section 17.3.3.19 Maturity of the trade item Added an Important Note to section 3.2 indicating that changes to the codes available for Trade Item Unit Descriptor are under discussion.
Issue 11	Feb-2010	M. Mowad M. Mowad JL. Leblond M. Mowad S. Brown JL. Leblond B. Couty D. Hoekstra S. Brown M. Mowad	Updated section numbering for all topics to "level 1" headings which will allow for more efficient maintenance... Section 7. Variable Measure Products (Non-Food) – Removed the following obsolete Note: The Fresh Foods section is currently under development and will contain Variable Measurement information upon completion. Section 13.3 – added additional guideline text to the Accepted CIC state: "Upon receipt of the message it may or may not be subject to additional internal validations by the Data Recipient". Added a reference and Link to the GTIN Allocation Rules in the "Related Documents" section and section 3.3. Added section 16 Variable Measure for Net Content Added section 17 Promotional Trade Item Extension Updated Section 6.4 How to Discontinue a Trade Item (Scenario 1) Section 2.7. Product Description – added a clarification note Updated all GDSN BMS references/ links to version 2.7
Issue 12	June-2010	G. Sobrino	Section 18 Packaging Type, Packaging Material, Platform Type Code List
Issue 13	Aug-2010	S. Brown	Updated Section 10. From " Net Weight " to " Trade Item Weight " to support the addition of Gross weight guidelines Added Section 19 Minimum and Maximum Values
Issue 14	Dec-2010	R. Kidd B. Szilagyi	Added section 20 Relevant Product Hierarchy Levels & Common Values

Release	Date of Change	Changed By	Summary of Change
Issue 15	Apr-2011	S. Brown B. Couty R. Kidd	Added section 2.4.1 - Mutually Exclusive Attributes Added section 21 - Order Sizing Factor
Issue 16	Aug-2011	W. Kolb R. Kidd G. Sobrino B. Zenner	Updated Section 16.1. Variable for One Measure with accurate with an accurate grossWeight of 11.2 Kg Updated Section 17 Promotional Trade Item Updated Section 18. Code List Added Section 25 - Healthcare
Issue 17	Jan-2012	S. Robba S. Brown S. Olsson K. Spooner	Added Section 22 - Tax Information in Trade Item Synchronisation Added Section 23 - Dates Added Section 24 - Regulatory Compliance Attributes Added Section 25. - Mergers, Acquisitions, & Divestitures
Issue 18	Jun-2012	S. Robba S. Robba G. Sobrino G. Sobrino S. Kasper S. Olsson M. Mowad Team Team	Updated Section 3 - Populating Net Content Updated Section 10 - Country of Origin Updated Section 18 - Packaging Type, Packaging Material, Platform Type Code List Updated Section 14 - Display Space Planning Added Section 26 - Repeatability of Extensions Corrected GTIN-13 appearing as an EAN-13 in section 28 Updated Section 23.3.9 Discontinued Date (Implementation Guidance) <u>GDS MR 2.8 Updates:</u> Section 3 - Populating Net Content Section 4 - Trade Item Unit Descriptors Section 5 - Populating TI/HI Section 7 - Variable Measure Products (Non-Food) Section 8 - Metric and Imperial Measurements Section 24 - Regulatory Compliance Attributes Section 26 - Food & Beverage Section 27 - Fresh Foods Product Hierarchy Common Values Spread Sheet
Issue 18.1	Dec-2013	S. Brown M. Mowad	Added Section 27 - Business to Government <u>Errata Updates/Corrections:</u> Updated links to external documents Updated Glossary terms and definitions (taken from the current GDD)
Issue 19	Mar- 2014	Team	<u>GDS MR 3.X Updates:</u> Section 2 - Overview Section 5 - TI/HI Section 13 - CIC Response to CIN Section 17 - Promotional Trade Item Section 22 - Duty Fee Tax Information Module Section 25 - Mergers, Acquisitions, & Divestitures Appendix 2 - Fresh Foods
Issue 20	May-2014	L. Lundquist P. Rosell	Added Section 28 - Packaging Sustainability Added Section A4 - Fruit & Vegetables
Issue 21	Jul-2014	S. Brown S. Robba	Added Section 29 - Population of Brand/Sub Brand Information Added Section 30 - Chemical Ingredients
Issue 22	Feb-2015	R. Prenger S. Robba C. Ramos	<u>Errata Updates/Corrections:</u> Section 3 - Populating Net Content: Updated calculation in Example 9 to 6650 ml and removed MR 3.X sunrise information

Release	Date of Change	Changed By	Summary of Change
			<p><u>GDS MR 3.X Updates:</u> Section 18 - Packaging, Platform Information Module <u>New Section:</u> Section 31: Attributes for "isTradeItem"</p>
Issue 22.1	July-2015	V. Hoste	<p><u>Applied new GS1 branding prior to publication</u> Annex 3, Healthcare, removed as posted elsewhere</p>
Issue 23.1	Oct 2015	M. Mowad	<p><u>GDS MR 3.1 Updates:</u> Section 4 - Trade Item Unit Descriptors</p>
Issue 24.1	Dec 2015	G. Sobrino E. Iwicka E. Kauz M. Mowad	<p><u>New Section:</u> Section 32: Food Lables Section 33: Use of Leading Zeros <u>GDS MR 3.1 Updates:</u> Section 6 - Discontinue Trade Item Section 23- Dates Appendix 1- Food & Beverage Errata updates to entire document</p>
Issue 24.2	Jun 2016	D.Buckley	<p><u>Errata:</u> Related documents: links updated for 3.1 release Appendix C 3.1 WR 16-241 changed definition of "Growing Method Code"</p>
Issue 25.1	Sep 2016	J. Ekestam M. Mowad S. Wijnker	<ul style="list-style-type: none"> • Annex A Food & Beverage: Section A4 added NutrientDetail declaration to table • Section 32 Food Label: Example 6 updates to the Nutrient Header Class in the table to avoid confusion • Section 34 Measurement Unit Codes: new section • Section 35 Components: new section <p><u>Errata: in the following sections, replaced code list definitions with links to the GDD:</u></p> <ul style="list-style-type: none"> • Section 14.3.1.2 displayDimensionTypeCode • Section 17.5 PromotionTypeCode • Section 18.3.3.1 PlatformTypeCode • Section 18.4.3.2 PackagingMaterialTypeCode • Section 27.2.3.5 Mandatory Attributes • Section 27.2.3.7 Optional Attributes • Section 31 Attributes for "isTradeItem" • ANNEX C.3.1 Fruit & Vegetables
Issue 25.2	Jan 2017	R. Prenger D.Buckley	<ul style="list-style-type: none"> • Errata: Table 18.1, removed "Roll" from the list because it is a valid packaging type & links corrected.
Issue 25.3	Sep 2017	M.Mowad D.Buckley	<ul style="list-style-type: none"> • Updates to Annex C (Fruit & Veg) from WR17-000079 • Section 32.19, Example 16 errata fix
Issue 26	Mar 2018	D.Buckley	<ul style="list-style-type: none"> • WR 17-000331, Update section 3.6, example 6 for Unit of Measure • WR 18-000020, Update section 35.4.1 on use of components • Section 31.6.1, errata fix removed reference to removed attribute IsTraeItemAFullDisplayStand
Issue 27	Jul 2018	D.Buckley	<ul style="list-style-type: none"> • WR 18-000016, new section 37 • WR 18-000095, errata correction to section 14.3.5.3 definition of positive nesting • WR 18-000144, new section 36
Issue 28	Dec 2018	D.Buckley	<ul style="list-style-type: none"> • WR 18-179, update to section 34 (Units of Measure added since last TIIG updated)

Release	Date of Change	Changed By	Summary of Change
			<ul style="list-style-type: none"> WR 18-291, errata fix to section 37.3.1.6
Issue 29	May 2019	D.Buckley	<ul style="list-style-type: none"> WR 18-120, errata fix to section 6 on GTIN non-reuse WR 18-383, errata fix to section 37.3.2.7 WR 19-063, new section 38 WR 19-120, errata fix to section 4.4.4
Issue 30	Jul 2019	D.Buckley	<ul style="list-style-type: none"> WR 19-122, section 34.6 cross reference to latest Unit of Measures
Issue 31	Sep 2019	D.Buckley	<ul style="list-style-type: none"> WR 18-220, new section 39 (Target consumer ages)
Issue 32	Nov 2019	D.Buckley	<ul style="list-style-type: none"> WR 18-389, new sub-section 30.7.4.3 (Guidance on how to exchange UFI (unique formula identifier)) WR 19-159, new section 40 (Usage of regulation attributes regarding compliance declaration)
Issue 33	May 2020	S.Robba, N.Eddaoudi, C. Willutzki, M.Alatypö, S.Brown, Z.Nazir, S.Wijnker, Ricardo Cerceau & Lourdes de Sousa	<ul style="list-style-type: none"> WR 19-198, new section 43 on Formatting for Descriptions WR 19-307, new section 41 on Nutritional Programs WR 20-011, new section 42 on Latex Attributes WR 20-134, errata fix in section 34 related to transposition issues implementing WR 18-179
Issue 33.0.1	Jun 2020	D.Buckley	<ul style="list-style-type: none"> WR 20-161, errata fix in Table 35-1 & correction of link
Issue 34	Mar 2020	S.Robba	<ul style="list-style-type: none"> WR 20-201, section 36 update for EUCAMED
Issue 35	Jun 2021	S.Robba	<ul style="list-style-type: none"> WR 21-129 New section 4.5.8 & Update 35.3.1 – Healthcare Hierarchy and update to Components usage
Issue 36	Feb 2022	D.Buckley	<ul style="list-style-type: none"> WR 22-061, errata new name and URL for <i>GS1 Package and Product Measurement Standard</i>
Issue 37	Mar 2024	D.Buckley, N.Minich, B. Faibella	<ul style="list-style-type: none"> WR 23-146 Section 13 updates to align with the application and use of the CIC with warning messages. WR 23-314 Section 4 update Trade Item Unit Descriptors table. WR 23-351 Section 43 describe how formatting pattern is to be provided. Errata updates to recognise GS1 Navigator has replaced the GDD.

Disclaimer

GS1®, under its IP Policy, seeks to avoid uncertainty regarding intellectual property claims by requiring the participants in the Work Group that developed this **GDSN Trade Item Implementation Guideline** to agree to grant to GS1 members a royalty-free licence or a RAND licence to Necessary Claims, as that term is defined in the GS1 IP Policy. Furthermore, attention is drawn to the possibility that an implementation of one or more features of this Specification may be the subject of a patent or other intellectual property right that does not involve a Necessary Claim. Any such patent or other intellectual property right is not subject to the licensing obligations of GS1. Moreover, the agreement to grant licences provided under the GS1 IP Policy does not include IP rights and any claims of third parties who were not participants in the Work Group.

Accordingly, GS1 recommends that any organisation developing an implementation designed to be in conformance with this Specification should determine whether there are any patents that may encompass a specific implementation that the organisation is developing in compliance with the Specification and whether a licence under a patent or other intellectual property right is needed. Such a determination of a need for licensing should be made in view of the details of the specific system designed by the organisation in consultation with their own patent counsel.

THIS DOCUMENT IS PROVIDED "AS IS" WITH NO WARRANTIES WHATSOEVER, INCLUDING ANY WARRANTY OF MERCHANTABILITY, NONINFRINGEMENT, FITNESS FOR PARTICULAR PURPOSE, OR ANY WARRANTY OTHERWISE ARISING OUT OF THIS DOCUMENT. GS1 disclaims all liability for any damages arising from use or misuse of this document, whether special, indirect, consequential, or compensatory damages, and including liability for infringement of any intellectual property rights, relating to use of information in or reliance upon this document.



GS1 retains the right to make changes to this document at any time, without notice. GS1 makes no warranty for the use of this document and assumes no responsibility for any errors which may appear in the document, nor does it make a commitment to update the information contained herein.

GS1 and the GS1 logo are registered trademarks of GS1 AISBL.

Table of Contents

1	Introduction	21
1.1	Who Will Use this Document?	21
1.2	Scope of this Document	21
2	Overview	21
2.1	What is GDSN?	21
2.2	Design Principle	22
2.3	Explanation of CIN "Core" Attributes vs. CIN Extensions	22
2.4	Key Data Attributes	23
2.4.1	Mutually Exclusive Attributes	23
2.5	Product Classification	24
2.6	Data Quality and Package Measurements	24
2.7	Product Description	25
2.8	Code Lists	26
2.9	Element and Attribute Naming	27
2.10	GDSN Major Release 3 (May 2016).....	27
3	Populating Net Content.....	27
3.1	Pre-requisites	27
3.2	When Would I Use This?	28
3.3	How to Implement Multiple Net Content Units of Measurement	28
3.4	Net Content vs. Net Weight	29
3.5	Net Content vs. Units per Trade Item	29
3.6	Examples of Multiple Net Content.....	29
4	Trade Item Unit Descriptors	34
4.1	Pre-Requisite	34
4.2	When Would I Use This?	34
4.3	How to Implement Trade Item Unit Descriptors.....	34
4.4	Examples of Trade Item Unit Descriptors.....	35
4.4.1	Each (EA)	35
4.4.2	Pack(PK).....	36
4.4.3	Case (CS)	36
4.4.4	Display Shipper (DS).....	36
4.4.5	Pallet (PL).....	36
4.4.6	Mixed Module (MX)	36
4.4.7	Transport Load (TL)	37
4.5	Examples of Item Hierarchies	37
4.5.1	Example 1	37
4.5.2	Example 2	38
4.5.3	Example 3	39
4.5.4	Example 4	40
4.5.5	Example 5	41
4.5.6	Example 6: Case with Multiple Children	42
4.5.7	Example 7: Transport Load	43
4.5.8	Example 8: Considerations for healthcare	44

5	Populating TI/HI	46
5.1	Pre-Requisites	46
5.2	When Would I Use This?	46
5.3	How to Populate the Key TI/HI Attributes.....	47
5.3.1	Step 1 – Decide whether you can use non-GTIN logistics unit or GTIN logistics unit	47
5.3.2	Step 2 – Select the relevant attributes	47
5.4	Examples	50
5.4.1	Example 1	50
5.4.2	Example 2	51
5.4.3	Example 3	51
5.4.4	Example 4	53
5.4.5	Example 5	55
5.4.6	Example 6	55
5.4.7	Example 7	56
5.5	Notes	58
5.5.1	Tip on Attribute Names.....	58
5.5.2	Stacking Factor	58
5.5.3	Stacking Factor Type.....	58
6	Discontinue a Trade Item	59
6.1	Why are Trade Items Discontinued.....	59
6.2	What is the Difference between Discontinuing a Trade item vs. Cancelling a Trade Item?.....	59
6.3	Pre-Requisite.....	59
6.4	How to Discontinue a Trade Item	59
6.4.1	Scenario 1 – Permanently Discontinue a Trade Item.....	60
6.4.2	Scenario 2 – Temporarily Discontinue a Trade Item	61
6.4.3	Scenario 3 – Continue Manufacturing a Trade Item After a Discontinue Date Has Been Set	62
7	Variable Measure Products (Non-Food)	62
7.1	Pre-Requisite.....	63
7.2	When Would I Use This?	63
7.3	How To?.....	63
7.3.1	Product that is fixed at the Despatch Unit Level and Variable at the Consumer Unit Level.....	63
7.3.2	Scenario A	63
7.3.3	Scenario B	64
7.3.4	Product that is Variable at both Despatch Unit Level and Consumer Unit Level.....	65
8	Metric and Imperial Measurements	66
8.1	Pre-Requisite.....	66
8.2	When Would I Use This?	66
8.3	Attributes in scope	67
8.3.1	Business Rules	67
8.3.2	Attributes not in Scope	68
9	Trade Item Weight.....	68
9.1	Pre-Requisite	68
9.2	When Would I Use This?	68
9.3	Validation Rule for Gross Weight	69

9.4	How to Calculate the Net Weight?	69
9.4.1	Example in Metric Measure – Net Content Expressed as Weight	69
9.4.2	Example in Metric Measure – Net Content Expressed as Volume	69
9.4.3	Example in Imperial Measure – Net Content Expressed as Weight	70
9.4.4	Example in Metric Measure – Net Content Expressed as an Each (Television)	70
9.4.5	Example in Imperial Measure – Net Content Expressed as an Each (Hair Dryers)	70
9.4.6	Example in Imperial Measure – Net Content Expressed as Usages (Detergent)	71
10	Trade Item Country of Origin	71
10.1	Pre-Requisite	72
10.2	When Would I Use This?	72
10.3	Examples of Country of Origin	72
11	Item Futurisation	73
11.1	Why Would I Use This?	73
11.2	Pre-Requisite	74
11.2.1	Pre-Requisites for Implementers	74
11.2.2	Pre-Requisites for Non-Implementers	74
11.3	When Would I Use This?	75
11.4	Explanation of Relevant Attributes	75
11.4.1	Effective Date	75
11.5	Attribute Restrictions – Can Any Attributes not be “Futurised”?	76
11.6	Explanation of the function of Dates in Item Futurisation	77
11.6.1	Initial Creation	77
11.6.2	Second Version	77
11.6.3	Third Version	78
11.6.4	Discontinue the GTIN	78
11.7	Scenarios for Item Futurisation Implementers: Both Implemented	79
11.7.1	Create and Publish a New GTIN	79
11.7.2	Create a New Future Version of a GTIN	79
11.7.3	Create an Intermediate Version of a GTIN	80
11.7.4	Change an Existing Future Version of a GTIN	80
11.7.5	Correct an Existing Future or Current Version of a GTIN	81
11.7.6	Change the Effective Date of an Item Version	81
11.7.7	Discontinue/Cancel a GTIN	82
11.8	Scenarios for Item Futurisation Data Recipient: Non-Implementers	82
11.9	Scenarios for Item Futurisation Data Source: Non-Implementers	82
11.9.1	Create and Publish a New GTIN from a Non-Implementer Source	82
11.9.2	Create a New Future Version of a GTIN from a Non-Implementer Source	82
11.9.3	Create an Intermediate Version of a GTIN from a Non-Implementer Source	83
11.9.4	Change an Existing Future Version of a GTIN from a Non-Implementer Source	83
11.9.5	Correct an Existing Future Version of a GTIN from a Non-Implementer Source	83
11.9.6	Discontinue a GTIN to a Non-Implementer Recipient	84
11.10	Other Useful Information	84
11.11	Advice for Data Pools	84
11.11.1	Technical Characteristics for Implementing Data Pools	84
11.11.2	Technical Characteristics for Non-Implementing Data Pools	84
11.11.3	Risks to be noted	85

12	Broker Distributor Model	85
12.1	Pre-Requisite	85
12.2	When Would I Use This?	85
12.3	How to Use These Guidelines	85
12.4	Brand Owner Retains Sole Synchronisation Responsibility	86
12.4.1	Contracted Distributor	86
12.4.2	Multi-National/Multi-Distributor Network	88
12.4.3	Broker Business Example.....	89
12.4.4	Item Synchronisation Scenario	90
12.5	Brand Owner Delegates Synchronisation Responsibility	91
12.5.1	Wholesale Business Example	91
12.5.2	Multi-National/Multi-Distributor Network	92
12.5.3	Private Label / Control Brand.....	93
12.5.4	Item Synchronisation Scenario	94
12.6	Shared Synchronisation Responsibilities	94
12.6.1	Sell to Distributor	95
12.6.2	Wholesale Business Example	96
12.6.3	Multi-National / Multi-Distributor Networks.....	97
12.6.4	Item Synchronisation Scenario	98
13	CIC Response to CIN	99
13.1	Pre-requisite.....	99
13.2	Examples of CIC Response Messages	99
13.2.1	Example 1	100
13.2.2	Example 2 (Error – Blocking).....	100
13.2.3	Example 3 (Error – Blocking).....	101
13.2.4	Example 4 (Error – Blocking).....	101
13.2.5	Example 5 (Error - Blocking)	101
13.2.6	Example 6 (Error – Blocking).....	101
13.2.7	Example 7 (Error – Blocking).....	102
13.2.8	Example 8 (Error -Blocking)	102
13.2.9	Example 9 (Error – Blocking).....	102
13.2.10	Example 10 (Error – Blocking).....	103
13.2.11	Example 11 (Error – Blocking).....	103
13.3	CIC States.....	103
13.4	Confirmation Status Codes:	104
13.5	Corrective Action Code Lists	105
13.6	Additional Resource Information	105
14	Display Space Planning	105
14.1	Pre-Requisite	105
14.2	When Would I Use This?	106
14.3	How to Send Data for Space Management.....	106
14.3.1	Dimensions	106
14.3.2	Examples.....	114
14.3.3	Packing Configuration.....	115
14.3.4	Orientation	118
14.3.5	Nesting.....	130
14.3.6	Inner Packs.....	135

14.3.7	Split Cases.....	136
15	Extended Attributes	137
15.1	Pre-Requisites	137
15.2	When Would I Use This?	138
15.3	Guiding Principles for Extended Attributes	138
15.4	Features of Extended Attributes	138
15.5	How to create or remove Extended Attributes	139
15.5.1	Process for Creation of Extended Attributes.....	139
15.5.2	Processes for the Removal of Extended Attributes.....	140
15.5.3	Attribute Harmonisation Leads to Work Request Submission Process.....	140
15.5.4	New GDSN Release Leads to Redundant Extended Attributes.....	141
15.6	Your Questions Answered.....	141
15.6.1	Are Extended Attributes the attributes in an Extension?.....	141
15.6.2	Are Extended Attributes part of the GS1 standards?.....	142
15.6.3	Are Extended Attributes the same as "AVP Attributes"?	142
15.6.4	What if my customer demands some non-standard data? Can I send it to him through the GDS Network?	142
15.6.5	What if my supplier cannot meet all my data needs through the GS1 GDSN Standards?.....	142
15.6.6	Can you explain the terminology? What "types" of attributes are supported?.....	142
15.7	Extended Attributes References	143
16	Variable Measure for Net Content.....	143
16.1	Variable for One Measure	144
16.1.1	Example 1	144
16.1.2	Example 2	144
16.2	Variable for more than one measure.....	145
16.2.1	Example 1	145
17	Promotional Item Information Module	145
17.1	Terms used in this Section	145
17.2	Pre-Requisites	146
17.3	When Would I Use This?	147
17.4	General Rule.....	147
17.5	How to Populate the Promotional Item Information Module.....	147
17.6	Examples of Promotional Trade Items.....	148
17.6.1	Free Quantity	148
17.6.2	"Low Price" Promotion, no Free Quantity Specified	156
17.6.3	Promotional Contest or Coupon	158
17.6.4	Free sample (That Cannot be Sold Separately to a Consumer).....	159
17.6.5	Free Gift	159
17.6.6	Unique Packaging (ex: Tin Box).....	160
18	Packaging, Platform Information Module	161
18.1	Who Will Use this?.....	161
18.2	Code Lists Packaging Type	161
18.2.1	Pre-Requisite.....	161
18.2.2	When Would I Use This?	161
18.2.3	How to Express the Packaging Type of the Trade Item?	162
18.3	Code Lists Platform Type.....	176

18.3.1	Pre-Requisite.....	176
18.3.2	When Would I Use This?	176
18.3.3	How to Express Platform Type Information?	176
18.3.4	Intermediate Bulk Containers	177
18.4	Code Lists Packaging Material	179
18.4.1	Pre-Requisite.....	179
18.4.2	When Would I Use This?	179
18.4.3	How To Express the Materials Used in a Trade Item?.....	179
18.4.4	How to Provide Further Details about the Packaging Materials?.....	180
18.5	Packaging Example	181
19	Min Max Values	181
19.1	Examples	182
20	Relevant Product Hierarchy Levels & Common Values.....	182
20.1	Why Would I Use This?	182
20.2	Pre-Requisites	183
20.3	When Would I Use This?	183
20.4	Explanation of the Report Contents	183
20.5	Implementation Considerations.....	185
20.6	Standards Maintenance Considerations	186
21	Order Sizing Factor	186
21.1	Pre-Requisites	186
21.2	Scenario 1: Truckload Sizing	186
21.2.1	Example 1: Similar Small Cases.....	186
21.2.2	Example 2: Mixed Product Densities.....	187
21.2.3	When Would I Use This?	188
21.3	Scenario 2: Pricing & Transport Optimisation	188
21.3.1	Example 1: Chocolate Bar 50grs x 6.....	188
21.3.2	Example 2: Bathroom Sponge	188
21.3.3	When Would I Use This?	189
22	Tax, Duties & Fees Information	189
22.1	Pre-Requisite	189
22.2	When Would I Use This?	189
22.3	How to communicate Trade item Tax Information	189
22.3.1	What Information can be communicated?	189
22.3.2	Examples.....	190
22.4	Code Conventions for Tax Agency and Tax Type	200
22.5	Applicable Validation Rules for Tax	200
22.5.1	GDSN Validation Rule 528.....	200
22.5.2	GDSN Validation Rule 533.....	200
22.5.3	GDSN Validation Rule 571.....	200
22.5.4	GDSN Validation Rule 578.....	200
22.5.5	GDSN Validation Rule 603.....	200
22.5.6	GDSN Validation Rule 618.....	201
23	Dates.....	201
23.1	Pre-Requisite	201

23.2	When Would I Use This?	201
23.3	Date Fields	201
23.3.1	Audio Visual Media Date Time.....	202
23.3.2	Availability Dates: Start & End.....	202
23.3.3	Campaign Dates: Start & End.....	203
23.3.4	Cancel Date	203
23.3.5	Certification Effective Date.....	204
23.3.6	Change Date	204
23.3.7	Consumer Availability Date	204
23.3.8	Community Visibility Date	205
23.3.9	Deposit Value Date	205
23.3.10	Discontinued Date.....	205
23.3.11	Effective Date.....	206
23.3.12	Exclusivity Date.....	206
23.3.13	File Effective Date.....	206
23.3.14	Max Buying Quantity Date	207
23.3.15	Min Buying Quantity Date	208
23.3.16	Order Date.....	208
23.3.17	Packaging Material Launch Date	209
23.3.18	Permit Date.....	209
23.3.19	Price Effective Dates	210
23.3.20	Production Variant Effective Date.....	210
23.3.21	Publication Date	210
23.3.22	Registration Date.....	211
23.3.23	Audio Visual Media Date Time.....	211
23.3.24	Returnable Date	211
23.3.25	Seasonal Availability Date.....	212
23.3.26	Ship and Delivery Date.....	212
23.3.27	Tax Type Effective Date.....	213
23.3.28	Registration End Date Time.....	213
23.3.29	Regulated Chemical Sunset Date	213
23.3.30	Content Date.....	214
23.3.31	Contributor Date.....	214
23.3.32	(Books & Periodicals Publication) Date.....	214
24	Regulatory Compliance Attributes.....	214
24.1	Pre-Requisites	214
24.2	When Would I Use This?	214
24.3	Guiding Principles for Regulatory Compliance.....	215
24.4	Contents of the regulatory compliance attributes	215
24.5	Examples	215
24.5.1	Pharmaceuticals in Sweden	215
24.5.2	MT Number	215
24.5.3	NPL-ID	215
24.5.4	NPL-Pack-ID.....	216
25	Mergers, Acquisitions, & Divestitures.....	216
25.1	Overview	217
25.1.1	Merger Defined.....	217

25.1.2	Acquisitions & Divestitures Defined	217
25.1.3	M&A GDSN Pre-Requisite	218
25.1.4	When Would I Use This?	218
25.1.5	Background Material	218
25.2	Business Definitions for terminology and dates used in various M&A Scenarios	218
25.2.1	Business Terminology	218
25.2.2	Date Terminology	223
25.3	M&A Best Practices for effective GDSN Item Catalogue Setup	224
25.3.1	New GTINs / New Information Providers	224
25.3.2	Advance Notification.....	225
25.3.3	Replacement and Replace by GTINs	225
25.3.4	Brand Ownership Change.....	225
25.3.5	Advance GTIN Publication	226
25.4	GDS Flexibility that drive varying Trading Partner Execution Partner and Core GDS Concepts	226
25.4.1	GDS Flexibility by Trading Partner.....	226
25.4.2	Core GDS Concepts.....	227
25.5	High-level Process Steps to execute a M&A.....	228
25.5.1	Key Factors for Managing a M&A via GDSN	230
25.6	M&A Business Scenario Summary	230
25.7	M&A Business Scenario Details	231
25.7.1	Situation 1: Complete Change.....	231
25.7.2	Situation 2: Changed Ownership Retains Item Numbers - with New Publisher	232
25.7.3	Situation 3: New Brand Owner Retains Old Item and Publisher Numbers	233
25.7.4	Situation 4: New Publisher, Data Unchanged.....	234
25.7.5	Situation 5: New Arrangements with No Change of Brand Owner.....	235
25.8	GS1 Change Situations & Steps Required	235
25.8.1	Situation 1: Complete Change.....	237
25.8.2	Situation 2: Changed Ownership Retains Item Numbers	239
25.8.3	Situation 3: New Brand Owner Retains Old Item and Publisher Numbers	241
25.8.4	Situation 4: New Publisher, Data Unchanged.....	242
25.8.5	Situation 5: New Arrangements with No Change of Brand Owner.....	244
25.8.6	M&A GDSN Situation Steps – A Non GDSN User.....	246
25.9	Retailer M&A Best Practices	246
25.10	Other Useful Information.....	247
26	Repeatability of Modules	247
26.1	General Remarks	247
27	Business to Government (B2G)	247
27.1	Who Will Use this?.....	248
27.2	Implementation Procedures.....	248
27.2.1	How would Governmental Agencies subscribe to GDSN Product Information?	249
27.2.2	How is product information published to the Governmental Agency?	250
27.2.3	What attributes are needed to support the B2G process?	252
28	Packaging Sustainability	256
28.1.1	General Considerations.....	256
28.1.2	Descriptions of Examples	259
28.1.3	GPPS Attributes	261



28.1.4 Life Cycle Assessment Indicators268

29 Population of Brand/Sub Brand Information..... 270

29.1 Pre-Requisite270

29.2 When Would I Use This?271

29.3 How to populate Brand Information271

29.3.1 What is the difference between a Brand Name and a Trade Item Name271

29.3.2 What significance does the Brand Name have to the ultimate user of the product?271

29.3.3 Why is “Brand Name” needed and what is it used for?272

29.3.4 Other important guidance272

29.4 Examples of Population272

29.4.1 Example 1273

29.4.2 Example 2274

29.4.3 Example 3275

29.4.4 Example 4276

29.4.5 Example 5277

29.4.6 Example 6278

29.4.7 Example 7279

29.4.8 Example 8280

29.4.9 Example 9281

29.4.10 Example 10.....282

29.4.11 Example 11.....283

29.4.12 Example 12.....284

29.4.13 Example 13.....285

29.4.14 Example 14.....286

29.4.15 Example 15.....287

29.4.16 Example 16.....288

29.4.17 Example 17.....289

29.4.18 Example 18.....290

29.4.19 Example 19.....291

29.4.20 Example 20.....292

29.4.21 Example 21.....293

29.4.22 Example 22.....294

29.4.23 Example 23.....295

29.4.24 Example 24.....296

29.4.25 Example 25.....297

29.4.26 Example 26.....298

29.4.27 Example 27.....299

30 Chemical Ingredients 300

30.1 Purpose of this Topic 300

30.2 Who Will Use this Document? 300

30.3 How will this work?.....301

30.4 Prerequisite 301

30.5 Implementation Procedures301

30.6 Recipient Process Steps302

30.7 Data Source Process Steps 302

30.7.1 Chemical Certification Information302

30.7.2 Chemical Regulation Information304

30.7.3	Registration Information	304
30.7.4	Chemical Supporting Documents	305
30.7.5	Safety Data Sheet Information	306
31	Attributes for "isTradeItem"	307
31.1	Pre-requisites	308
31.2	When Would I Use This?	308
31.3	isTradeItemABaseUnit	308
31.3.1	Implementation Guidance/Validations/Business Rules.....	308
31.3.2	Example	308
31.4	isTradeItemAConsumerUnit	308
31.4.1	Implementation Guidance/Validations/Business Rules.....	308
31.4.2	Example	309
31.5	isTradeItemAVariableUnit.....	309
31.5.1	Implementation Guidance/Validations/Business Rules:	309
31.5.2	Example	309
31.6	isTradeItemADisplayUnit.....	309
31.6.1	Implementation Guidance/Validations/Business Rules:	310
31.6.2	Example	310
31.7	isTradeItemADespatchUnit	310
31.7.1	Implementation Guidance/Validations/Business Rules.....	310
31.7.2	Example	310
31.8	isTradeItemAnOrderableUnit.....	310
31.8.1	Implementation Guidance/Validations/Business Rules.....	311
31.8.2	Example	311
31.9	IsTradeItemAnInvoiceUnit.....	311
31.9.1	Implementation Guidance/Validations/Business Rules:	311
31.9.2	Example	312
31.10	isTradeItemNonPhysical	312
	31.10.1 Validation rules using isTradeItemAPhysicalUnit can be found in the BMS GDSN Validation Rules. 312	
32	Food Labels	312
32.1	Pre-Requisite	312
32.2	When Would I Use This?	313
32.3	Communicating Food Label Information	313
32.4	Example 1: All Nutrient Information	313
32.4.1	Image 1	313
32.4.2	Image 2	314
32.5	Example 2: Daily Value Intake and Daily Value Table Footnote	320
32.6	Example 3: Ingredients and Contact Information	324
32.7	Example 4: Brand, Sub Brand, Variant.....	327
32.8	Example 5: Ingredients and allergens.....	328
32.9	Example 6: Nutrients, preparation state, regulated product name, nutritional claim	330
32.10	Example 7: Net content, package marks environment	332
32.11	Example 8: Address and Contact Information	333
32.12	Example 9: Marketing Message and Storage Instructions	334
32.13	Example 10: Consumer Pack with Unmarked Multiple Components.....	335
32.14	Example 11: Nutrient Information	346

32.15	Example 12: Brand, sub brand, functional name, variant	347
32.16	Example 13: Ingredients and allergens	348
32.17	Example 14: Nutrition Facts	353
32.18	Example 15: Preparation (Instructions).....	356
32.19	Example 16: Food Service Master Case Label	358
33	Use of Leading Zeroes	363
33.1	GTINs and leading zeroes in Data Carriers.....	363
33.2	GTINs and leading zeroes in GS1 XML (including GDSN) attributes with data type GTIN.....	363
33.3	GTINs and leading zeroes in GS1 XML (including GDSN) attributes with data type string.....	363
33.4	Summary.....	364
34	Measurement Unit Codes.....	365
34.1	Purpose of this Document	365
34.2	Who Will Use this Document?	365
34.3	Pre-Requisite	365
34.4	When Would I Use This?	365
34.5	GDS Attributes & GDS Units of Measure + Measurement Unit Code Categories	365
35	Components	365
35.1	Objective	365
35.2	Audience.....	365
35.3	Definition of the Class Components	366
35.3.1	Component Definition.....	366
35.3.2	Heterogeneous Product.....	366
35.4	Delimitations to similar Attributes and Functionalities in Trade Item	366
35.4.1	When to use, or not use, components?.....	366
35.4.2	Which information should I supply?.....	367
35.5	The class and attributes per definition	367
35.6	How to Implement Components	368
35.7	Modules	368
35.8	Examples of Components	369
35.8.1	Pizza Kit with two components	369
35.8.2	Camping set containing 1 table and 4 chairs.....	370
35.8.3	A multipack with four different ice creams with different nutritional information, ingredient statements and/or allergen information	371
35.8.4	Resin Kit with Hazardous Information.....	373
35.8.5	Perfume or Essential oils with hazardous information	374
35.9	Examples of items where components should not be used.....	374
35.9.1	Gift pack consisting of one bottle of shampoo and one bottle of conditioner	374
35.9.2	A multipack with three different sausages which are individually packed and marked (not components).....	375
36	Target Markets	376
36.1	Country Code usage for indicating Target Market	376
36.1.1	Country code.....	376
36.1.2	001 – Global Market & D_A – Development Assistance	376
37	Transportation, Dangerous and Hazardous Information.....	377
37.1	Introduction	377

37.1.1	Acronyms used	378
37.2	Safety Data Sheets	378
37.3	Attributes description	378
37.3.1	GHS (Globally Harmonized System) of Classification and Labelling of Chemicals	378
37.3.2	ADR	381
37.4	Reference materials and examples	388
37.4.1	Code lists of GHSSymbolDescriptionCode and gHSSymbolCode	388
37.4.2	ADR tunnel restriction code EXAMPLE	389
37.4.3	ADR Class of Dangerous Goods.....	390
37.4.4	Dangerous Goods Classification code usage EXAMPLE.....	391
37.4.5	Dangerous goods special provisions usage EXAMPLE	392
37.4.6	United Nations dangerous goods number usage EXAMPLE.....	393
37.4.7	Dangerous Hazardous Label Number and Dangerous Hazardous Label Sequence Number usage EXAMPLE	394
37.4.8	Dangerous Goods Hazardous Code usage EXAMPLE.....	395
38	Hallmarks, Accreditations and Regulatory Labels management	396
39	Target consumer age group, introduction	397
39.1	Why do we need a common range for each code.....	397
39.2	Usable codes for each age range.....	397
40	Usage of regulation attributes regarding compliance declaration	398
40.1	Scenario 1: Additional regulatory attributes are not used	399
40.2	Scenario 2: Additional regulatory attributes are used.....	399
40.3	Scenario 3: Compliance declaration is not used.....	400
40.4	Scenario 4: Regional regulatory applicability.....	400
41	Nutritional Programs.....	401
41.1	Introduction to Nutri-Score.....	401
41.1.1	Nutri-Score, what is it?.....	401
41.1.2	How is it assigned ?	402
41.1.3	Which products are included (affected) ?	402
41.1.4	Issuance of the trademark	402
41.1.5	Populating attributes for Nutri-Score in GDSN	403
41.1.6	External additional documentation	403
42	Guide for Latex attributes	403
42.1	Introduction	403
42.1.1	Latex as Allergen - allergenTypeCode	404
42.1.2	doesTradeItemContainLatex.....	405
42.1.3	doesTradeItemCompositionIncludeLatex	405
42.1.4	doesPackagingMaterialsContainLatex.....	405
42.1.5	packagingMarkedFreeFromCode FREE_FROM_LATEX	405
43	Formatting for Descriptions	406
43.1	Descriptions Single Value per Language (Multiple languages allowed)	406
43.2	Descriptions Multiple Values per Language (Multiple languages allowed)	407
43.3	Formatted Descriptions One Value per Language (Multiple languages allowed).....	407
43.4	Formatted Descriptions Multiple Values per Language (Multiple languages allowed).....	408

43.5	Descriptions One Value, One Language	408
43.6	Formatting Pattern Examples.....	408
43.6.1	Formatted Description using BBCode	408
43.6.2	The reason for the design	408
43.6.3	Suggestions for implementing Formatted Description in GUI based systems.....	408
43.6.4	BBCode Syntax.....	409
43.6.5	Simple example: String with formatted text elements	409
43.6.6	Complex example: Styled ingredients list.....	409
A	Food & Beverage.....	411
A.1	Pre-Requisite	411
A.2	When Would I Use This?	411
A.3	How to use the Food & Beverage Extension	412
A.4	Production Variant Effective Date and Production Variant Description.....	412
A.5	Food & Beverage Ingredient Class and Ingredient Statement.....	412
A.6	Food & Beverage Allergen Class and Allergen Statement.....	412
A.7	Nutrient Type Code and Unit of Measure	413
A.8	Food & Beverage Module Examples	413
B	Fresh Foods	421
B.1	Pre-Requisite	421
B.2	When Would I Use This?	421
B.3	How To?.....	421
C	Fruit & Vegetables	431
C.1	General Guidance.....	431
C.2	Purpose and Scope.....	431
C.3	Master Data Attributes & Definitions	431
C.4	Managing Equivalent Trade items in the Auction/Broker Scenario	444
C.5	Global Product Classification	445
C.6	Use Cases	445
C.7	Packaging Type Codes	456
C.8	IFPS Color Code List	463

1 Introduction

This document supplements the formal GS1 Global Data Synchronisation Network (GDSN) standards with advice on their implementation and operation. This document is in no way normative or definitive and is not a standard. It includes implementation guides for a variety of the more complicated issues encountered when implementing the standards outlined by this document. It seeks to increase consistency and ease of implementation by explaining the standards and providing real-world examples.

1.1 Who Will Use this Document?

Business users who are implementing or operating GDSN may use this document to supplement the formal GDSN standards with additional guidance.

This document is aimed primarily at business users who need to understand the data content or process standards. Technical users involved with implementation may also find topics of interest.

1.2 Scope of this Document

The scope is the data and processes for the synchronisation of Trade Items within the GDSN.

For this issue of the document the scope is limited to a few high priority topics which have been identified by GS1 as sources of confusion. It is intended that future versions will expand the scope to cover additional topics that require detailed explanation and examples related to GDSN Trade Item synchronisation.

Until this document is complete, if information is sought about a procedure or attribute not yet covered, users should see formal GDSN Standards as published in the [GDSN Trade Item for Data Alignment Business Message Standard \(BMS\)](#)

For additional training or advice please contact your solution provider, data pool, or GS1 member organisation.

2 Overview

2.1 What is GDSN?

The Global Data Synchronisation Network (GDSN) is an internet-based, interconnected network of interoperable data pools and a global registry that enable companies around the globe to exchange standardised and synchronised supply chain data with their trading partners. It assures that data exchanged between trading partners is accurate and compliant with universally supported standards.

GDSN is built around the GS1 Global Registry, GDSN-Certified Data Pools, the GS1 Data Quality Framework, and GS1 Global Product Classification, which when combined provide a powerful environment for secure and continuous synchronisation of accurate data. Trade items are identified using the GS1 identification key called Global Trade Item Numbers (GTIN). Partners and locations are identified by the GS1 identification key called Global Location Numbers (GLN). A combination of GTIN, GLN and Target Markets (the geographical area where the catalogue item is intended to be sold) allows information to be shared in the Network.

GDSN allows trading partners to share the latest information in their systems. Any changes made to one company's database can be automatically and immediately provided to all of the other companies who subscribe to the data through GDSN. When a supplier and a customer know they are looking at the same accurate and up-to-date data, it is smoother, quicker and less expensive for them to do business together. The GDSN provides a single point of truth for product information.

How GDSN Works

There are six simple steps that allow trading partners to synchronise item, location and price data with each other:

1. **Load Data:** The seller registers product and company information in its data pool.
2. **Register Data:** A small subset of this data is sent to the GS1 Global Registry.
3. **Request Subscription:** The buyer, through its own data pool, subscribes to receive a seller's information.
4. **Publish Data:** The seller's data pool publishes the requested information to the buyer's data pool.
5. **Confirm & Inform:** The buyer may send a confirmation to the seller via each company's data pool, which informs the supplier of the action taken by the retailer using the information.
6. **Updates:** The seller continues to publish updates to the Item throughout the lifecycle of the product. The buyer should then update their systems to keep the Item data in sync.

Additional Information

- For more information on GDSN standards and implementation please see [GDSN website](#).
 - [How GDSN Works](#)
 - [GDSN-Certified Data Pools](#)
 - [GS1 Data Quality Framework](#)
 - [GS1 Global Product Classification \(GPC\)](#)
- For more information on GS1 identification keys, GTIN, GLN and please see [GS1 Id keys](#).

2.2 Design Principle

The Data Sync Trade Item model was built keeping in mind the design of the GDSN data synchronisation process developed for implementation by GS1.

The key principle that is carried over from that work is the assumption that when a trade item's information is transmitted from an information provider to a data pool, and data pool to data pool (in network data synchronisation) that the entire product hierarchy is transmitted.

For example, in the grocery industry that product hierarchy will normally include retail point-of-sale, case, and pallet, and may also include other levels. Included in this product hierarchy, it is understood that each link connecting the various levels is also considered to be a part of the message.

2.3 Explanation of CIN "Core" Attributes vs. CIN Extensions

The GDSN Catalogue Item Notification (CIN) contains a set of attributes which are grouped in different modules, also known as attribute classes and attribute subclasses. A list of modules has been defined for each context based on the characteristics of the product and/or industry sector. For example, the Nutritional Information Module is relevant for food products which would be published with the context "Food, Beverage, Tobacco, & Pet Food"; the Apparel Information Module is relevant for clothing and footwear products which would be published with the context "Clothing and Personal Accessories".

The attributes within each module are either mandatory, optional, or dependant. All modules should be handled in the item sync message in alphabetical order. Some modules will contain as a subclass the Attribute/Value Pair (AVP) functionality as well. Furthermore, several extension points will be provided for additional data sets if needed. In addition to the content related modules, the CIN will contain the core attributes which are mandatory and must be used with all contexts.

- **Note:** If the data source chooses to send one or more modules which are not in the list of modules defined for the context, the data pools will pass the additional modules through to the data recipient. However, the data source should bear in mind that the data recipient may not be expecting the additional modules for that context and may or may not be able to process them.

2.4 Key Data Attributes

This GDSN model works off a basic principle. The entire set of data attributes assigned to a Global Trade Item Number (GTIN) may vary depending on who provides the information, and in which target market the data is relevant.

Within the global data synchronisation environment, the combination of three key attributes, Global Location Number (GLN) of information provider, GTIN of the trade item, and the Target Market identifies a unique set of values for the trade items' attributes. This combination can also affect which attributes are communicated. In general, the values of attributes can vary for a GTIN when GLN of information provider or Target market are changed.

- **Example** – "orderingLeadTime" may vary depending on target market. (US delivery within 3 days, delivery within Belgium is less than 1 day)
- **Example** – "cataloguePrice" may vary depending on the information provider (catalogue price equals \$1.00 from manufacturer, but is \$1.05 in the information set communicated by a distributor)
- **Important:** All variation must be compliant with GTIN Management Standard per the GS1 General Specifications. Variations that do not comply will require a new GTIN.

The following list of attributes are examples that should not vary by Target Market or Information Provider GLN:

- | | |
|------------------------------|---|
| ■ GTIN | ■ Country of origin |
| ■ GPC Category Code | ■ Quantity of next lower level trade item |
| ■ Brand Owner (GLN) | ■ Net content |
| ■ Brand | ■ Net content UOM |
| ■ Sub Brand | ■ Is trade item a base unit |
| ■ Functional name | ■ Is trade item a consumer unit |
| ■ Variant | ■ Is trade item a variable unit |
| ■ Trade item unit descriptor | ■ Cancelled date |

As stated above, in addition possible variations in values for the same attribute, the list of attributes communicated may change based on these three keys. Changes in the information provider can change the list of attributes associated with a GTIN.

- **Example** – Information provider A chooses to provide values for 50 attributes for a GTIN, while information provider B chooses to provide values for 100 attributes for the same GTIN, seeing this as a competitive advantage.

The relevant target market can also affect the selection of attributes. Certain target markets will have legal requirements for some attributes, while other target markets will not.

- **Example** – "dangerous goods" attributes are currently required in certain countries. Parties that do not operate in these countries will not be required to communicate these attributes to their customers.

2.4.1 Mutually Exclusive Attributes

There may be attributes within a class that are mutually exclusive and are designated within the XML schema as "Choice".

"Choice" in a class of attributes means either one or an alternate attribute is mandatory. The choice is between two or more attributes; however, only one attribute can be selected. If a class is invoked with "choice" attributes, one of the attributes must be populated or the message will not pass validation.

For example, if the "GS1 Exception" class is invoked, a user must populate either a Message Exception or a Transaction Exception, but not both.

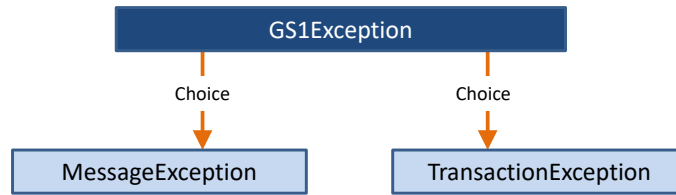

- **Note:** XML “Choice” is infrequently used in GDS. Instead, Validation Rules (VRs) can be implemented where applicable.

2.5 Product Classification

The Trade Item contains a primary product classification which is the GS1 Global Product Classification (GPC). It also allows for additional product classifications, e.g. country or industry specific classifications, for the purpose of mapping.

The GPC schema provides a four tier hierarchy including Segment, Family, Class and Brick.

Table 2-1 Product Classification Hierarchy

Level	Definition	Example
Segment	An industry segment or vertical.	Food/Beverage/Tobacco
Family	A broad division of a segment.	Milk/Butter/Cream/Yogurts/Cheese/Eggs/Substitutes
Class	A group of like categories.	Milk/Milk Substitutes
Brick	Categories of like products.	Milk/Milk Substitutes (Perishable)

The GPC brick code is mandatory in the GDSN and is sent in the **gpcCategoryCode** field in the Catalogue Item Notification (CIN) message (e.g., 10000025 - Milk/Milk Substitutes (Perishable)).

The CIN message also enables the sending of GPC attributes associated with a Brick. GPC Brick Attributes provide additional descriptive granularity for a GPC Brick for example:

Core Attribute Value Code	Core Attribute Value Description
20000123	Level of Fat Claim

Core Type Value Code	Core Attribute Value Description
30002967	LOW FAT

For more information on GPC, please see [GPC Website](#).

2.6 Data Quality and Package Measurements

Good quality data is foundational to collaborative commerce and global data synchronisation. Good quality data means that all master data is complete, consistent, accurate, time-stamped and industry standards-based. GDSN has adopted a best practice framework for global data quality. To review the related information on this initiative, please see [GS1 Data Quality Framework](#).

Packaging measurements and packaging measurement tolerances are a key component of quality data. Detailed information can be found in the following documents which are located on the [GDSN standards website](#).

- **GS1 Package and Product Measurement Standard** – provides detailed rules on how to measure a consumer unit and a non-consumer trade item

For additional training or advice please contact your solution provider, data pool, or GS1 member organisation

2.7 Product Description

Product Description (known in the GS1 standard as **tradeItemDescription**) is an attribute used within GDSN to provide an understandable and useable description of a trade item.

While not obligatory, the structure for the product description can be populated using the following four attributes:

- Brand
- Sub Brand
- Functional Name
- Variant

Example 1:

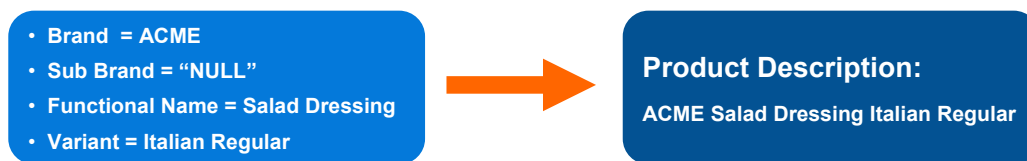

Example 2:

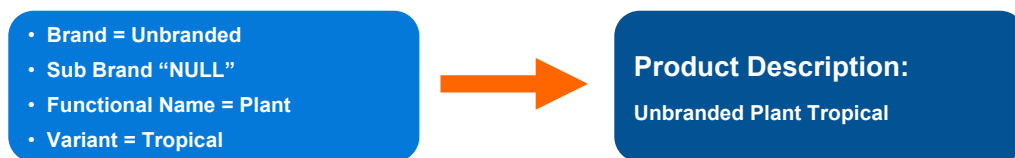

Example 3:

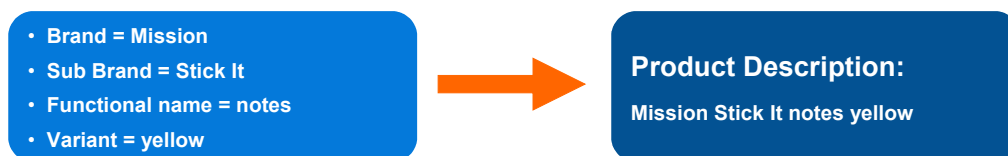

- **Note:** Information providers should refer to local implementation guidelines as to how to populate attribute tradeItemDescription.

2.8 Code Lists

The Trade Item Document utilises GS1 defined code lists as well as lists managed externally (e.g. UNCEFACT, ISO). Most code lists are managed outside of the schema due to both frequency of update and requirements that vary between target markets. These externalised code lists will have a data type named specifically for the code list, for example preparationTypeCode. These data types provide a string in the schema for the code value to be entered.

GS1 differentiates the following types of code lists:

GS1 Code Lists:

These are lists whose values are published as part of the GS1 standard, but have no general usage outside of the published GS1 standards. They are owned, managed, and published by GS1.

- **Enumerations** - These are lists whose values are included as part of the GS1 schemas. These are limited to document commands (i.e. Add, Delete) or object states (i.e. rejected, review). The enumerated code list have typically very few values and are highly unlikely to change. Any additions to these code lists requires publishing of new maintenance release.
- **GS1 code lists not enumerated in the schemas** – these are code lists developed and managed by GS1, but are only published in the standard, not included in the schemas. Extension of these code lists does not require publication of the maintenance release.

Non-GS1 Code Lists:

- **Non-GS1 Code Lists Fully Adopted** - The content of these lists are maintained by agencies other than GS1 and are not included as part of the GS1 standards and/or schemas. These code lists are restricted by the external agencies (e.g. ISO, or UN/CEFACT).
- **GS1 Restricted and Extended Code Lists** - The content of these code lists is based on lists maintained by agencies other than GS1, but only a subset of the original values has been allowed for use in GDSN standards (GS1 restricted code lists). Some original code lists have been modified by adding new, GS1-specific values (GS1 Extended code lists). These code lists are not included in GS1 schemas.

Table 2-2 Externally Managed Code Lists

Code List	Comments
ISO 639-1	Codes for the representation of names of languages Available for purchase at the following website: http://www.iso.org/
ISO 3166-1	Part 1 – Country Codes (Three Digit Format) Available for purchase at the following website: http://www.iso.org/
ISO 3166-2	Part 2 – Alpha Country Subdivision Available for purchase at the following website: http://www.iso.org/
ISO 4217	Codes for the representation of currencies and funds Available for purchase at the following website: http://www.iso.org/
UN INFOODS	Codes to describe food components (nutritional) The latest values are freely available the following website: http://www.fao.org/infoods/infoods/standards-guidelines/food-component-identifiers-tagnames/en/
UNECE Rec 5	Codes for representing INCOTERMS Codes are freely available the following website: https://unece.org/trade/uncefact/cl-recommendations
UNECE Rec 20	Codes for representing units of measure Note: This is a restricted and extended list and the values to be used in GDSN can be found in the GS1 standard. The full list of all Rec 20 values are freely available at the following website: https://unece.org/trade/uncefact/cl-recommendations

Code List	Comments
UNECE Rec 21	Codes for representing types of packaging Note: This is a restricted and extended list and the values to be used in GDSN can be found in the GS1 standard. The full list of Rec 21 values are freely available at the following website: https://unece.org/trade/uncefact/cl-recommendations

2.9 Element and Attribute Naming

All element and attribute names begin with a lower case. All words that follow in the name are capitalised, or in other words, elements and attributes appear in “CamelCase”. For example,

- additionalTradeItemIdentification
- contentOwner

2.10 GDSN Major Release 3 (May 2016)

The GDSN Major Release greatly improves implementation time for new sectors beyond Consumer Package Goods (CPG). It eases restrictions previously in place to meet legacy business requirements, and uses the concept of ‘Context’ to drive descriptive Trade Item information which is appropriate and necessary for each industry sector.

Benefits of the GDS Major Release 3 include:

- Introduction of a smaller module-based data model that better supports sector specific trading partner needs
- Setting an expectation of shorter timelines for sectors to implement GDSN
- Eliminating need (in certain scenarios) for non CPG sectors to exchange CPG attributes that were not applicable to their business model
- Replacing a single set of CPG-centric business rules applied to all sectors with validations that are meaningful to and based on sector specific business rules
- Enabling faster GS1 standards development and community implementation for new business requirements

3 Populating Net Content

This section describes how to populate net content in the GS1 Global Data Synchronisation Network (GDSN).

Definition of Net Content is the total amount of the trade item contained by a package, usually as claimed on the label. For example if a consumer trade item is a 6 pack of 4oz. applesauce the net content of this consumer trade item is 24 oz. (see additional examples in [Section 3.6 Examples of Multiple Net Content](#))

Manufacturers will determine the values to be sent. Retailers may need to perform a conversion in their company to meet their system requirement needs.

3.1 Pre-requisites

- Manufacturers must have capability and may provide all net content declarations on the consumer level package.
- Retailers will determine which of the multiple net content declarations received from the manufacturer they require.
- In certain geographies, local regulations do not require net content below a specific size to be declared on the consumer package. Manufacturers and Retailers will collaborate to identify these local variations

- Where mandated legally, manufacturers must provide the net content unit of measurement designated for use in consumer price comparison. This locally regulated net content unit of measurement is to be communicated in the "Price Comparison" attribute fields to ensure regulatory compliance.

3.2 When Would I Use This?

When a consumer level package carries multiple declarations of net content, manufacturers may be able to provide all declarations provided. At minimum, where only one net content declaration exists, one net content will be communicated.

For consumer level products that are comprised of components with different units of measure and sold as single consumer unit "1" is to be used to convey that the net content is one consumer unit. The recommendation is to use **count**, **each**, or **unit** as the unit of measure for these products. These three expressions of unit of measure have the same meaning.

Certain geographies require by law that specific net content units of measurement be used for "consumer price comparison" purposes. Manufacturers and retailers will collaborate to identify these regulatory needs. In these circumstances, the consumer price comparison field may in fact duplicate a value contained in the net content field, so both may carry it.

3.3 How to Implement Multiple Net Content Units of Measurement

Multiple units of measurement for net content is determined from the information contained on the consumer label (based on the default front) as defined in Section 6 of the [GS1 General Specifications](#).

- **Note:** A complete listing of all GS1 Member Organisations is available on the GS1 website at <https://www.gs1.org/contact>

Net Content value and unit of measurement is repeatable without limit. Multiple Net Content declarations may result from:

- The use of 2 measurement systems on the package, imperial and metric. Where both are provided, they must be equivalent values as declared on the package (see example 2)
- A combination of weights and volumes on the package
- Usage information about the product
- A product that is a "kit" such as pest control kit (see example 8)
- Any or all combinations of the above

Other important rules to remember when working with Multiple Net Content Units of Measurement:

- All Multiple units of measurement are equally important. There is no principal, secondary, or tertiary, etc. ranking. Therefore the sequence in which multiple net content declarations are provided is irrelevant – any sequence is acceptable.
- It is not mandatory to send more than one net content
- When the consumer unit contains products with uncommon units of measurement or different products expressed as **each** – it is recommended to use one **count**, one **each**, or one **unit**.
- All declared net contents by the manufacturer must comply with [GTIN Management Standard](#).
- **Note:** Recipients should keep in mind that certain units of measure are interchangeable and should be mapped properly to the recipient's needed Unit of measure. For example, the units of measure that may be interchangeable are "Each, Count, Unit or Piece".

3.4 Net Content vs. Net Weight

Many companies interchange the attributes net content and net weight. These attributes are not the same in all instances. For example, a box of tea bags that contains 18 tea bags and has a net weight of .82 ounces will have a net content of 18 count. However, a bag of candy that has a net weight of 12 ounces will have a net content of 12 ounces.

3.5 Net Content vs. Units per Trade Item

Net Content, even when expressed as a count, should not be confused with Units Per Trade Item. Units Per Trade Item is a numeric value to indicate number of physical pieces used to make up the Consumer Unit. It is used if there is more than one piece in one Trade Item.

For example a hi-fi set might consist of 4 boxes (tuner, CD player, amplifier, loudspeakers). The Net Content would have a count/each/unit of 1, meaning a single hi-fi set, but the Units Per Trade Item would be 4, meaning that it is supplied in 4 boxes.

3.6 Examples of Multiple Net Content

The following section illustrates several examples of Multiple Net Content

Example 1: Vitamins

- Net content = 300 count

Figure 3-1 Vitamin Example



Example 2: Shampoo

- Net content = 13 fl oz
- Net content = 384 ml

Figure 3-2 Shampoo Example



Example 3: Ice-cream Bars

- Net content = 18 fl oz
- Net content = 532 ml
- Net content = 6 count

Figure 3-3 Ice Cream Example



- **Note:** To illustrate how this might work for the data receiver, imagine the receiver wants to know not only how many bars are in the Item but also how big each bar is. Net Content always reflects the total content for the Item identified by the GTIN, never a sub-division of it. The data receiver receives 18 fl oz, so they need to divide the count = 6 to get 3 fl oz per bar, not as $6 \times 18 = 108$ fl oz.

To calculate the volume of each bar, the data receiver should divide the Net Content (in volume) by the Net Content (in count):

- **Imperial:** $18 \text{ fl oz.} / 6 = 3 \text{ fl oz. per bar}$
- **Metric:** $532 \text{ ml.} / 6 = 88.7 \text{ ml. per bar}$

Example 4: Water Ice

- Net content = 464 ml
- Net content = 8 count

Figure 3-4 Water Ice Example

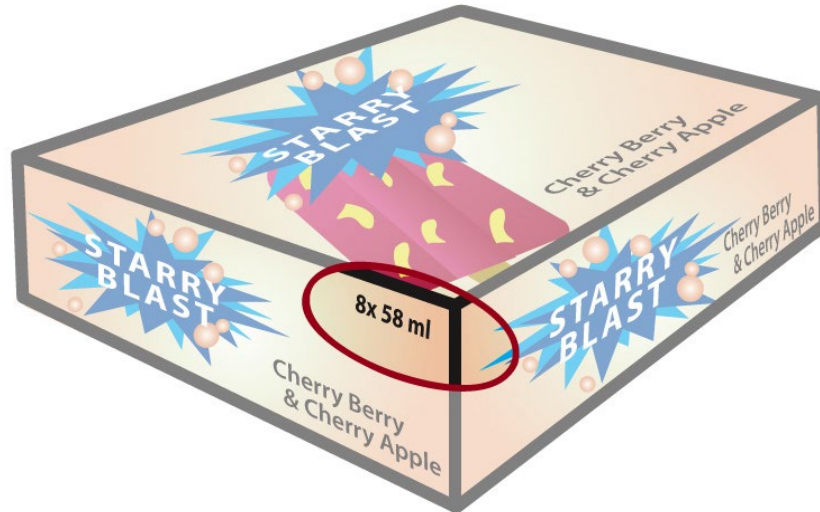

Example 5: Yogurt

- Net content = 9 lb
- Net content = 4.080 kg
- Net content = 24 count

Figure 3-5 Yogurt Example



Example 6: Laundry Detergent

- Net content = 300 FL OZ
- Net content = 2.34 Gal
- Net content = 8.87L
- Net content = 96 loads (recommended unit of measure code is H87 [piece])

Figure 3-6 Laundry Detergent Example



Example 7: Bathroom Tissue

- Net content = 225 Sq Ft
- Net content = 20.9m²
- Net content = 1800 sheets
- Net content = 9 rolls

Figure 3-7 Bathroom Tissue Example

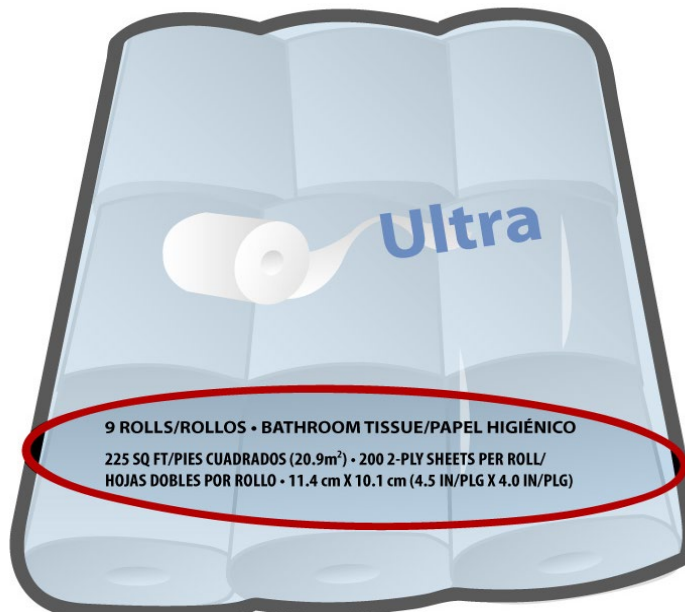

Example 8: Pest Control

When trade item contains products with uncommon UOMs or different products expressed in **eaches**

- Net content = 1 Count

Figure 3-8 Pest Control Example

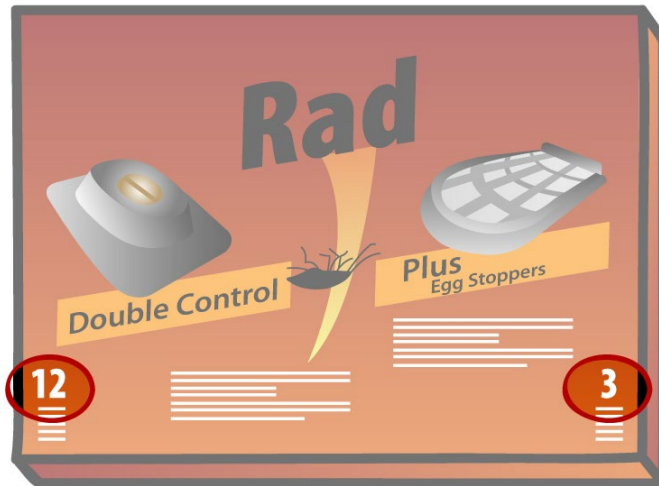

Example 9: Concentrated Orange Juice

For concentrated orange juice in a 950 ml package, the consumer is supposed to add 6350 ml of water to make 7300 ml of juice. (Comparison price is by Swedish law calculated based on the measurement after preparation.)

- Net Content: 950 MLT
- Price Comparison Content: 7300MLT
- Price Comparison Content Type: READY_TO_DRINK.

Figure 3-9 Concentrated Orange Juice Example

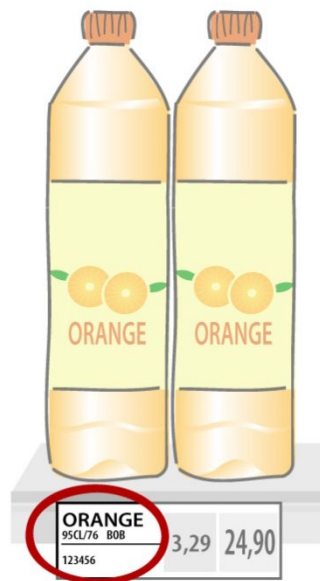

4 Trade Item Unit Descriptors

The attribute **tradeItemUnitDescriptor** is used to describe the GTIN hierarchy level. Hierarchy is used to establish a link between different levels of a product logistical chain. Another term for item hierarchy is item containment. Item containment provides a method of identifying the contents of a GTIN that is a packaging hierarchy rather than a consumer unit. This can occur multiple times depending upon the number of levels in the hierarchy.

- **Important:** All components of each potential level of packaging must already be defined in order to be used in Item Containment. Each level in the item hierarchy must be identified with a GTIN and a trade item unit descriptor to be sent in GDSN.

4.1 Pre-Requisite

GTINs must be registered in the GS1 Global Registry to build the item hierarchy.

4.2 When Would I Use This?

The trade item unit descriptor is a mandatory attribute in the GDSN CIN. This attribute is also used to define what level of the item hierarchy an attribute is relevant at. For example **tradeItemCountryOfOrigin** is relevant for the product hierarchy level of "Each"

Before creating a publication the manufacturer will use the trade item unit descriptor to create the parent/child GTIN relationship. Child GTIN is a reference to the GTIN of the next lower level of trade item that is contained in the item hierarchy.

4.3 How to Implement Trade Item Unit Descriptors

The following information is provided in Table 1:

- **tradeItemUnitDescriptor** - code value of Trade Item Unit Descriptors (commonly used by some of the trading partners)
- **Definition** of the trade Item unit descriptor
- **Parent** – provides guidance of the trade item unit descriptors that can be a parent of a lower level GTIN when the item hierarchy (link) is created.
- **Child** – provides guidance of the trade item unit descriptor that can be a child of a higher level GTIN when the item hierarchy (link) is created
- **Child Instances** – indicates if the GTIN contains a single instance of a GTIN or several unique GTINs

Table 4-1 Trade Item Unit Descriptors

tradeItemUnitDescriptor	Description	Parents	Children	Child Instance
TRANSPORT_LOAD (TL)	The trade item above the pallet level used for transporting trade items. This level can be used to define truckloads, shipping containers, rail cars, ships, etc. This level can contain a single GTIN or multiple GTINs.	TL, None	TL, PL, MX, CS, DS, PK, EA	Single/Multiple
PALLET (PL)	A unit load that contains a single or multiple GTINs that is not display ready. Includes box pallet.	TL, PL, None	PL, MX, CS, DS, PK, EA	Single/Multiple
MIXED_MODULE (MX)	A unit load that is a "display ready pallet" that may contain a single GTIN or several unique GTINs that is intended to go directly to the selling floor.	TL, PL, MX, None	PL, MX, CS, DS, PK, EA	Single/Multiple
CASE (CS)	A standard trade item shipping unit. Includes a 1/2 or 1/4 pallet and a 1/2 or 1/4 b box pallet.	TL, PL, MX, CS, DS, None	CS, DS, PK, EA	Single/Multiple
DISPLAY_SHIPPER (DS)	A shipping unit that is a display which can contain a single instance of a GTIN or more than one unique instance of a GTIN.	TL, PL, MX, CS, DS, None	DS, CS, PK, EA	Single/Multiple
PACK_OR_INNER_PACK (PK)	Is a logistical unit or a consumer unit between a case and each. This level can contain a single GTIN or multiple GTINs.	TL, PL, MX, CS, DS, PK, None	PK, EA	Single/Multiple
BASE_UNIT_OR_EACH (EA)	The lowest level of the item hierarchy intended or labelled for individual resale.	TL, PL, MX, CS, DS, PK, None	NONE	NONE

- **Note:** 1/2 or 1/4 pallet are terms typically used in European markets (see Section [4.5.3](#))
- **Note:** A Pallet and a Case formerly were limited to a single child GTIN. As a result of this limitation, Mixed Module, and a Display Shipper were allowed to have a single child or multiple children, therefore used to support Mixed case, Mixed Pallet that were not true displays. This limitation was removed as of December 2012.
- **Note:** The Case abbreviation has changed from "CA" to "CS".

4.4 Examples of Trade Item Unit Descriptors

4.4.1 Each (EA)

- **Example 1**– simple each – a single box of cereal
- **Example 2** – complex each (**the components are NOT barcoded**)
 - An each consisting of four of the same exact canisters of peanuts.
 - An each with three white tee shirts sold in a single pack.
 - An each of three pack of sport socks.
 - A box of hot cocoa that contains 10 envelopes
 - An each that is a variety that may consist of 3 potato chips, 2 pretzels, and two corn chips (exact variety may change per pack).

4.4.2 Pack(PK)

All components of the pack typically have their own separate scannable bar codes physically attached.

- **Example 1** – consumable pack (also described as a bundle pack) – Acme sells a bundle pack consisting of three of the same canisters of potato chips. The bundle pack has an overwrap that has a unique bar code that represents the three pack. The canisters that are the components of the bundle pack are physically bar coded with the GTIN that represents a single canister.
- **Example 2** – non-consumable pack (most commonly described as a shrinkwrap or inner pack) Acme shampoo companies packs six of its 500 ml shampoo bottles in a non-bar coded plastic overwrap, and then packs three of these 6 packs into a standard cardboard container.
Note: This Trade Item has been assigned a GTIN (aka unmarked GTIN)
- **Example 3** – three of the same size and colour tee shirts that are normally sold individually are overwrapped and carry a unique bar code that represents the three pack. Each tee shirt inside the bundles pack is in a poly bag that has a physical bar code representing each single tee shirt.
- **Example 4** – consumable pack: Acme sells a gift pack consisting of a 200 ml bottle of shampoo, a 200 ml bottle of conditioner and a 150 ml can of deodorant. The gift pack as well as all three components are individually bar coded.
- **Example 5** - PK as a parent of a PK – 3 bars of the same soap are overwrapped and have a unique bar code that represents the bundle pack (PK). 4 of these bundle packs are put in a shipping sleeve (PK) that is not barcoded, and two sleeves are packed in a case.

4.4.3 Case (CS)

- **Example 1** – Acme 1 litre orange juice bottles are packed in a standard 24-pack configuration within a cardboard case
- **Example 2** – Acme intravenous fluid bags are packed in a standard 12-pack configuration within a plastic returnable tote.
- **Example 3**– 24 each of a single hammer in one tray
- **Example 4** – 12 each of a single hat in one case
- **Example 5** – 10 small, 20 medium and 20 large white tee shirts are packed in one mixed case.

4.4.4 Display Shipper (DS)

- **Example 1** – Acme distributors offers their five best selling products in a ready to set up cardboard display which is designed to be set up at store entrances.
- **Example 2** – Acme Tea Company offers a variety pack of different flavours of their iced tea within the same shipping container. This mixed case can be used by retailers to stock their shelves, or offered directly to consumers for purchase.
- **Example 3** – a counter top display of lipsticks and nail polish

4.4.5 Pallet (PL)

- **Example 1** – while buyers may order in smaller quantities if they wish, seller offers its Acme soap powder in standardised pallet quantities of 100 cases 10 TI/10 HI per pallet which optimises their logistical efficiency.
- **Example 2** – Acme dairy offers its 1-gallon milk containers in a standardized roll cart fixture that contains 96 gallons.

4.4.6 Mixed Module (MX)

- **Example 1** – manufacturer offers a configuration that consists of several of its related products; brooms, mops, brushes and cleansers as a “spring cleaning display” (multiple GTINs). Only one display fits on the shipping platform.
- **Example 2** – manufacturer offers 12 microwaves for sale on a display (only one GTIN). Only one display fits on the shipping platform.

4.4.7 Transport Load (TL)

- **Example 1** – a manufacturer may offer a shipping unit for transportation purposes. The product is manufactured overseas and the manufacturer communicates the Transport Load identifying 10,000 units will fit in a container which is assigned a GTIN as it is a standard configuration. The buyer may order in container quantities for transportation and logistical benefits.

4.5 Examples of Item Hierarchies

4.5.1 Example 1

A PALLET (PL) that contains a child GTIN of BASE_UNIT_OR_EACH (EA)

Assumption: A unit load that is not “display ready” and contains a single instance of an each.

Table 4-2 Trade Item Unit Descriptors Example 1

tradeItemUnitDescriptor	Description	GTIN	tradeItemIdentificationOfNextLowerLevelTradeItem (GTIN)	quantityOfNextLowerLevelTradeItem	quantityOfChildren (different GTIN)
PL	72 kitchen paper packets	13133200112618	03133200112611	72	1
EA	kitchen paper packet	03133200112611	X	X	X

X = not applicable

Figure 4-1 Trade Item Unit Descriptors Example 1

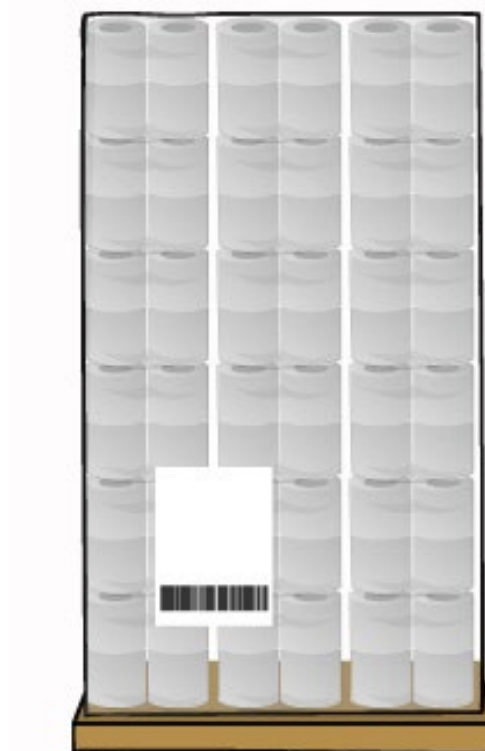

4.5.2 Example 2

A PALLET (PL) that contains a child GTIN of CASE (CS) that contains a Child GTIN of BASE_UNIT_OR_EACH (EA)

Assumption: A unit load that is not “display ready” and contains a single instance of a case. The case contains a single instance of an each.

Table 4-3 Trade Item Unit Descriptors Example 2

tradeItemUnitDescriptor	Description	GTIN	tradeItemIdentificationOfNextLowerLevelTradeItem (GTIN)	quantityOfNextLowerLevelTradeItem	quantityOfChildren (different GTIN)
PL	240 cases	23041090004821	13041090004824	240	1
CS	12 jars of baby food	13041090004824	03041090004827	12	1
EA	1 jar of baby food	03041090004827	X	X	X

X = not applicable

Figure 4-2 Trade Item Unit Descriptors Example 2

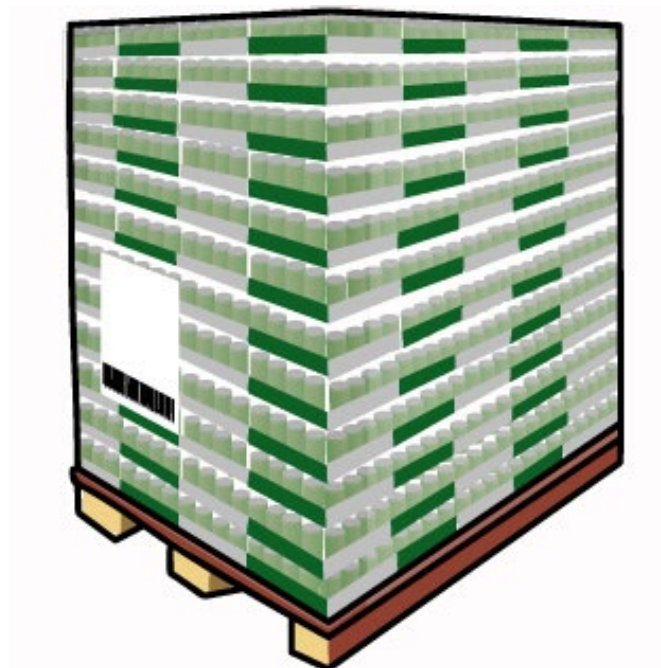

4.5.3 Example 3

A PALLET (PL) that contains a child GTIN of CASE (CS) (half pallet) that contains a Child GTIN of BASE_UNIT_OR_EACH (EA)

Assumption: a Unit load that contains two ½ pallets that are wrapped and shipped as one unit. Case (half pallet) contains a single instance of an each.

Table 4-4 Trade Item Unit Descriptors Example 3

tradeItemUnitDescriptor	Description	GTIN	tradeItemIdentificationOfNextLowerLevelTradeItem (GTIN)	quantityOfNextLowerLevelTradeItem	quantityOfChildren (different GTIN)
PL	2 half pallets	13265474396026	13265474396019	2	1
CS (half pallet)	288 oil bottles	13265474396019	03265471024086	288	1
EA	1 oil bottle	03265471024086	X	X	X

X = not applicable

Figure 4-3 Trade Item Unit Descriptors Example 3

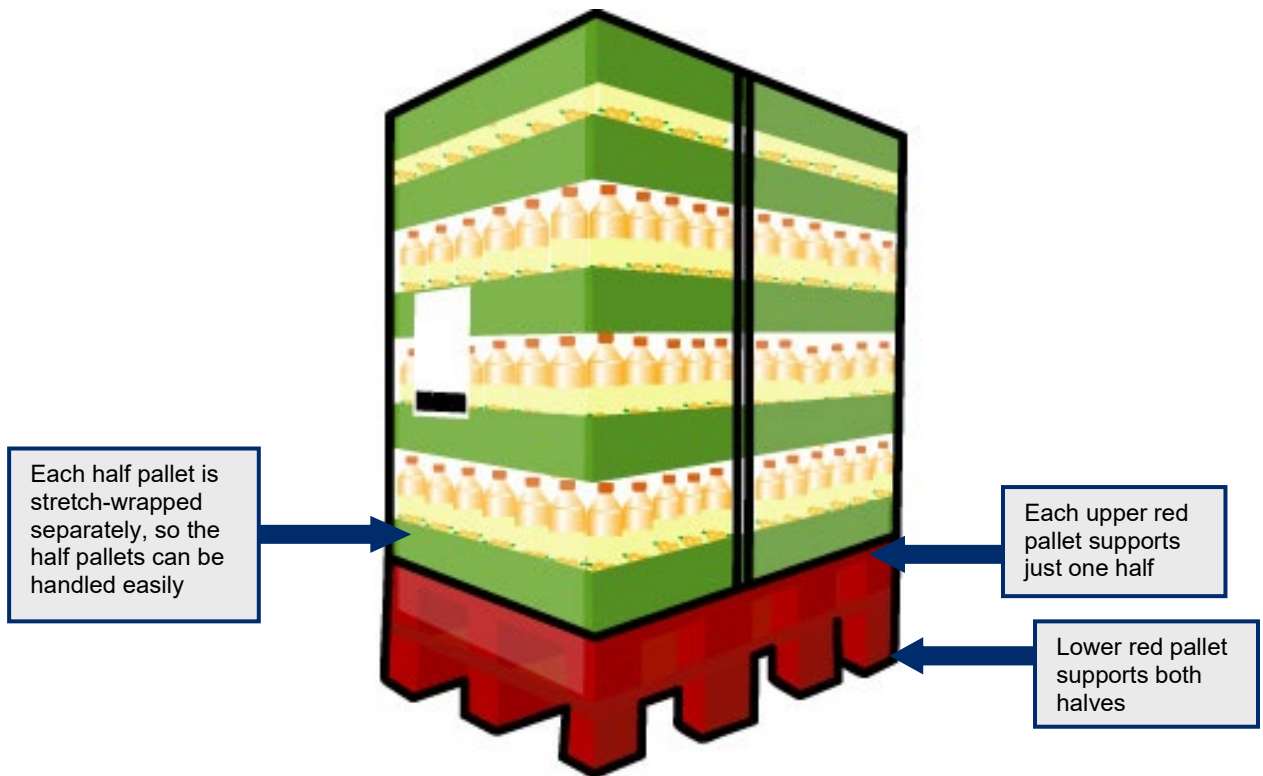

4.5.4 Example 4

A PALLET (PL) that contains a child GTIN of DISPLAY_SHIPPER (DS). The DS contains three unique GTINs of PACK_OR_INNER_PACK (PK) and two unique GTINs of BASE_UNIT_OR_EACH (EA). Every PK contains a single instance of a child GTIN.

Assumption: A unit load that is not “display ready” and contains a single instance of a display case.

Table 4-5 Trade Item Unit Descriptors Example 4

tradeItemUnitDescriptor	Description	GTIN	tradeItemIdentificationOfNextLowerLevelTradeItem (GTIN)	quantityOfNextLowerLevelTradeItem	quantityOfChildren (different GTIN)
PL	8 display cases	08714789157818	08714789152516	8	1
DS	25 packs toothpaste A x 2 20 packs toothpaste B x 2 15 packs toothpaste C x 2 20 toothbrushes A 20 toothbrushes B	08714789152516	08714789121871 08714789121857 08714789121895 08714789110530 08714789110554	25 20 15 20 20	5
PK	2 toothpaste A tubes	08714789121871	08714789119601	2	1
EA	Toothpaste A tube	08714789119601	X	X	X
PK	2 toothpaste B tubes	08714789121857	08714789119625	2	1
EA	Toothpaste B tube	08714789119625	X	X	X
PK	2 toothpaste C tubes	08714789121895	08714789119649	2	1
EA	Toothpaste C tube	08714789119649	X	X	X
EA	Toothbrush A	08714789110530	X	X	X
EA	Toothbrush B	08714789110554	X	X	X

X = not applicable

- **Note:** [Figure 4-4](#) is the picture of the display shipper (DS) and the Pallet (PL) would contain a total quantity of **8**.

Figure 4-4 Trade Item Unit Descriptors Example 4

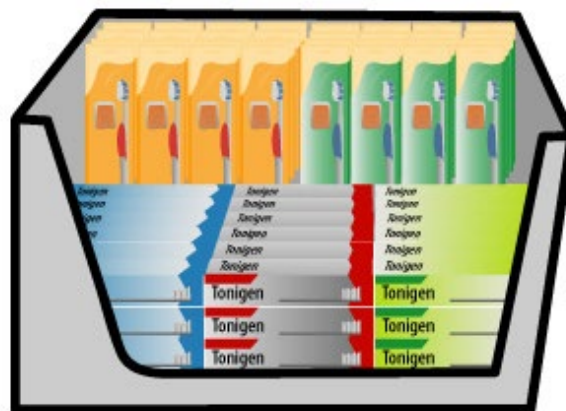

4.5.5 Example 5

A MIXED_MODULE (MX) that contains four unique child GTINs of PACK_OR_INNER_PACK (PK). Each PK contains a single instance of a child GTIN of BASE_UNIT_OR_EACH (EA).

Assumption: A unit load that is “display ready”.

Table 4-6 Trade Item Unit Descriptors Example 5

tradeItemUnitDescriptor	Description	GTIN	tradeItemIdentificationOfNextLowerLevelTradeItem (GTIN)	quantityOfNextLowerLevelTradeItem	quantityOfChildren (different GTIN)
MX	252 packs chocolate A x 5 100 packs chocolate B x 4 80 packs chocolate C x 4 80 packs chocolate D x 3	7622200996162	7622400900594 7622400931093 7622400931079 7622400968679	252 100 80 80	4
PK	5 chocolate bars A	7622400900594	3045140105502	5	1
PK	4 chocolate bars B	7622400931093	3045140280803	4	1
PK	4 chocolate bars C	7622400931079	7622400893124	4	1
PK	3 chocolate bars D	7622400968679	7622400730894	3	1
EA	chocolate bar A	3045140105502	X	X	X
EA	chocolate bar B	3045140280803	X	X	X
EA	chocolate bar C	7622400893124	X	X	X
EA	chocolate bar D	7622400730894	X	X	X

X = not applicable

Figure 4-5 Trade Item Unit Descriptors Example 5

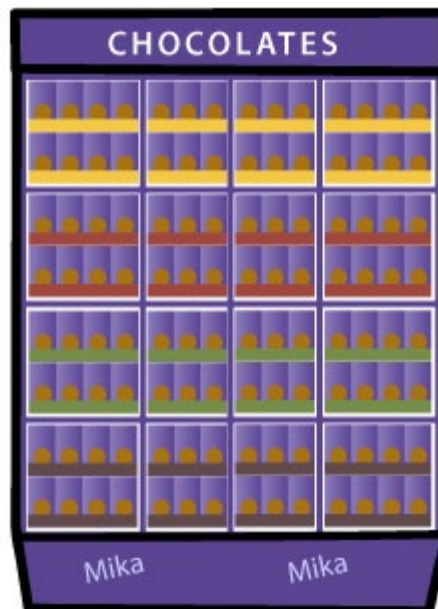

4.5.6 Example 6: Case with Multiple Children

A CASE (CS) that contains children with different GTINs. It is not meant to be a display (shelf ready). A CS with multiple children can also be a ¼ or ½ pallet.

Table 4-7 Trade Item Unit Descriptors Example 6

tradeItemUnitDescriptor	Description	GTIN	tradeItemIdentificationOfNextLowerLevelTradeItem (GTIN)	quantityOfNextLowerLevelTradeItem	quantityOfChildren (different GTIN)
CS	24 juice boxes of 4 different varieties	7622200996162	7622400900594 7622400931093 7622400931079 7622400968679	6 6 6 6	4
EA	1 juice box lemon	7622400900594	X	X	X
EA	1 juice box lime	7622400931093	X	X	X
EA	1 juice box orange	7622400931079	X	X	X
EA	1 juice box strawberry	7622400968679	X	X	X

X = not applicable

Figure 4-6 Trade Item Unit Descriptors Example 6



4.5.7 Example 7: Transport Load

A TRANSPORT_LOAD (TL) that contains a standard configuration of children. The container comprises 2 PALLET (PL) GTINs which have standard unit loads. One pallet has children of a CASE (CS) and a BASE_UNIT_OR_EACH (EA). The other pallet has children of a CS, an INNER_PACK_OR_PACK (PK) and an EA.

Assumption: A TL, in this scenario, bears a GTIN which means that it may be orderable, invoiceable, shippable, or need to have specific information shared about it. Whenever it uses this GTIN it MUST have the same consist or hierarchy. If a Container varies from one shipment to the next, it would not be assigned a GTIN, but would use a Serial Shipping Container Code (SSCC).

Note: A TL can be a Less Than Truck Load (LTL) standard shipment, a Container or Truck, a Rail Car, a Cargo Plane, a Ship, or any standard unit load which is larger than a single Pallet.

Table 4-8 Trade Item Unit Descriptors Example 7

tradeItemUnitDescriptor	Description	GTIN	tradeItemIdentificationOfNextLowerLevelTradeItem (GTIN)	quantityOfNextLowerLevelTradeItem	quantityOfChildren (different GTIN)
TL	50' container of paper goods	00614141000043	20614141000030	22	2
			20614141000023	20	
PL	25 bundles of paper towels	20614141000030	10614141000033	25	1
CS	bundle of 10 packages of paper towels	10614141000033	00614141000036	10	1
EA	package of 8 rolls of paper towels (Point-of-sale (POS) Unit)	00614141000036	X	X	X
PL	30 cases of facial tissue	20614141000023	10614141000026	30	1
CS	case of 24 packs of facial tissues	10614141000026	00614141000029	24	1
PK	pack of 8 boxes of facial tissue (Point-of-sale (POS) Unit)	00614141000029	00614141000012	8	1
EA	box of facial tissues (Point-of-sale (POS) Unit)	00614141000012	X	X	X

X = not applicable

Figure 4-7 Trade Item Unit Descriptors Example 7

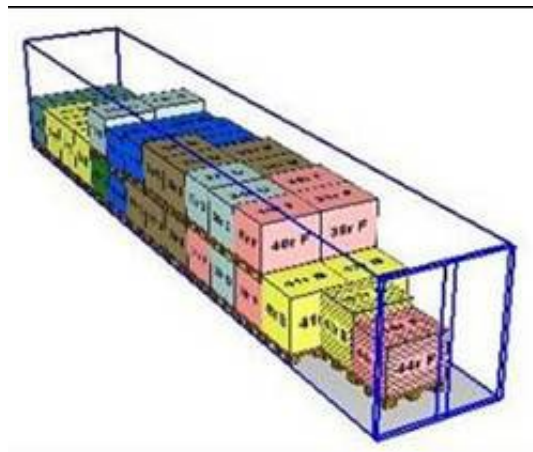

4.5.8 Example 8: Considerations for healthcare

The healthcare supply chain does not end at a point of sale. It extends into the customers' organisations all the way to the point of care. Accordingly, these customers (i.e. the healthcare providers) may need GTINs and master data on all levels of an item hierarchy down to the Unit of Use (i.e. the single pill, ampoule, or device used in a procedure). This is irrespective of whether the item is individually packaged, or whether the item itself or its package is marked with a data carrier including a GTIN. At the discretion of the data source, the synchronisation of master data may include the lowest level of any hierarchy, i.e. the Unit of Use, to meet these needs.

The following figures show trade item hierarchies for medical devices ([Figure 4-8](#)) and drugs ([Figure 4-9](#) and [Figure 4-10](#)) with one level ([Figure 4-8](#) and [Figure 4-9](#)) or two levels ([Figure 4-10](#)) below the level colloquially called the "each", i.e. the smallest package or the retail package. All hierarchy levels have GTINs assigned to them.

For communicating data about these trade item hierarchies, the data source has two options:

Communicate the GTIN of the Unit of Use as a component of the next higher trade item, i.e. the "Each" in Figures 1 and 2 and the "Blister card" in Figure 3; the latter would have BASE_UNIT_OR_EACH assigned as their TradeItemUnitDescriptor value. This way the data source circumvents the necessity to generate a full trade item record with all the required attributes for the Unit of Use. See section 35 for more information about components.

Communicate the data on the Unit of Use in a regular trade item record, which would then have BASE_UNIT_OR_EACH assigned as its TradeItemUnitDescriptor value. This method is preferable if the data source wants to communicate more information about the Unit of Use than could be associated with a component.

Figure 4-8 Hierarchy with a unit of use

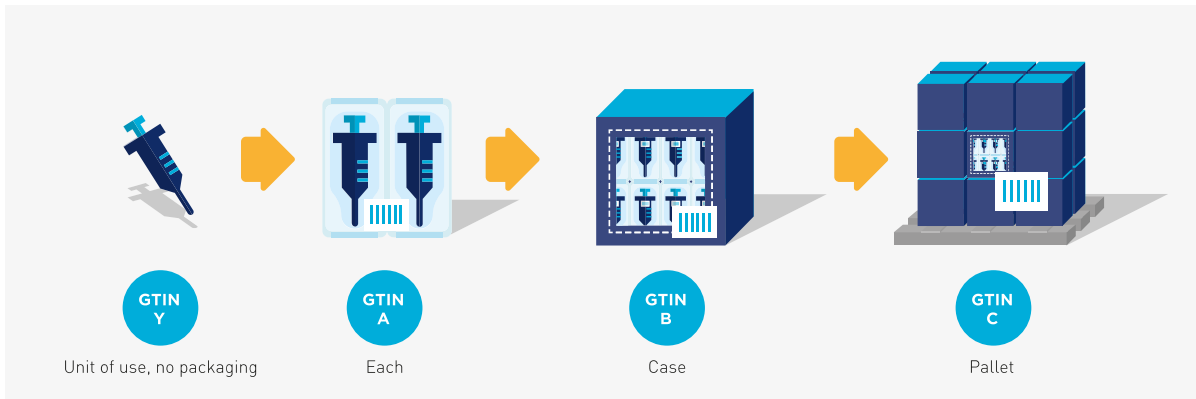
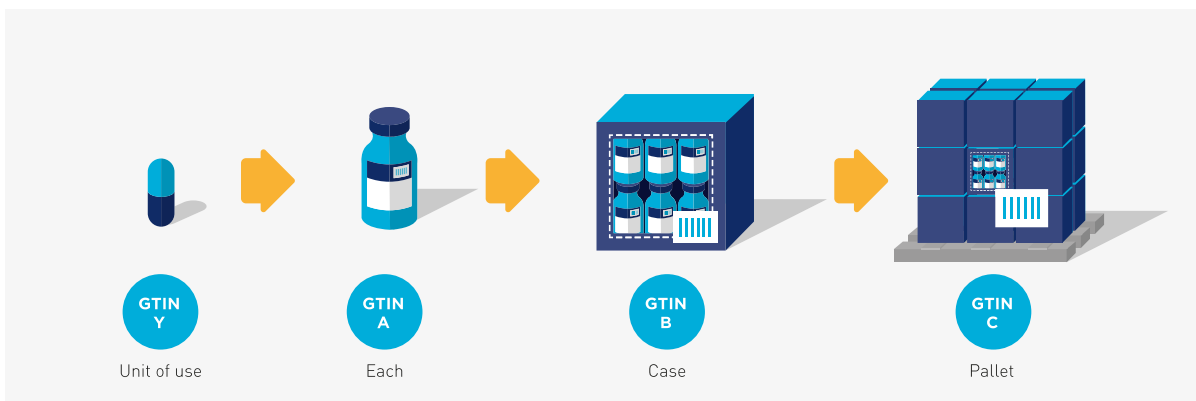

Figure 4-9 Hierarchy with a single unit



TradeItemUnitDescriptor values for communicating complete trade item hierarchies down to the Unit of Use as depicted in the [Figure 4-8](#) and [Figure 4-9](#)

	GTIN Y	GTIN A	GTIN B	GTIN C
--	--------	--------	--------	--------

TradeItemUnitDescriptor values for communicating complete trade item hierarchies down to the Unit of Use as depicted in the Figure 4-8 and Figure 4-9				
Option 1	(Component Information)	BASE_UNIT_OR EACH	(appropriate higher level)	(appropriate higher level)
Option 2	BASE_UNIT_OR EACH	(appropriate higher level)	(appropriate higher level)	(appropriate higher level)

"appropriate higher level" meaning values appropriate for the respective levels above the one designated BASE_UNIT_OR_EACH (See [Table 4-1](#))

Figure 4-10 The blister card is identified and marked with a single GTIN. The unit of use is identified with a GTIN but is not marked. The marking is at the discretion of the brand owner

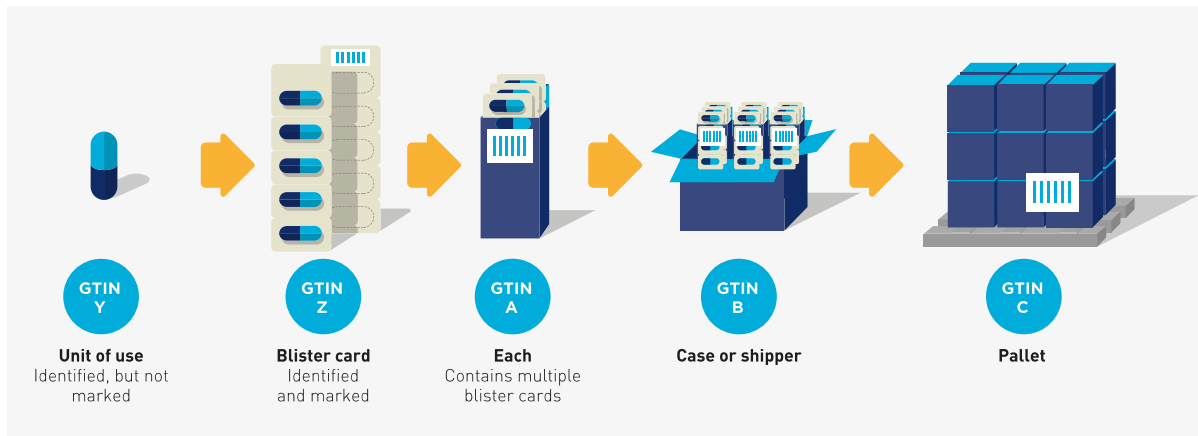

TradeItemUnitDescriptor values for communicating complete trade item hierarchies down to the Unit of Use as depicted in the Figure 4-10					
	GTIN Y	GTIN Z	GTIN A	GTIN B	GTIN C
Option 1	(Component Information)	BASE_UNIT_OR EACH	(appropriate higher level)	(appropriate higher level)	(appropriate higher level)
Option 2	BASE_UNIT_OR EACH	(appropriate higher level)	(appropriate higher level)	(appropriate higher level)	(appropriate higher level)

"appropriate higher level" meaning values appropriate for the respective levels above the one designated BASE_UNIT_OR_EACH (See [Table 4-1](#))

- Note:** Data sources who choose to transmit their master data to regulatory databases (like the Global Unique Device Identification Database (GUDID) of the United States Food and Drug Administration (FDA)) through a GDSN data pool should refer to the appropriate UDI regulatory requirements for product identification requirements. For this purpose, one of the options might be better suited than the other. For information on these matters data sources should refer to the information on the [GS1 Healthcare website](#) and should also consult with their data pool provider."

The subsequent higher hierarchy levels will need appropriate TradeItemUnitDescriptor values, see [Table 4-1](#). Since none of the TradeItemUnitDescriptor values implies whether the trade item carrying it is orderable, invoiceable, or shippable, the data source needs to communicate these properties using the appropriate "isTradeItem" attributes, see section [31](#).

5 Populating TI/HI

TI/HI is a concept used to describe how product is stacked on a platform such as a pallet. The "**TI**" is the number of cartons on a layer, and the "**HI**" is the number of layers of cartons on a platform or pallet. The TI/HI for the example pallet displayed in the figure below would be 10x4.

Figure 5-1 TI/HI Example

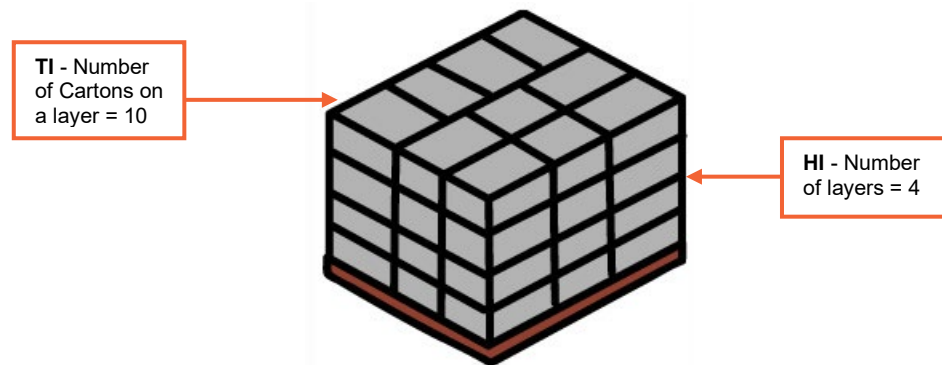

This section explains how to populate attributes describing how a trade item is palletised or otherwise prepared into a unit load (also sometimes known as a logistics unit). One of the most common forms of unit load is the palletised unit, used for transportation and storage purposes.

Some companies use a GTIN to identify a standard palletised unit (or other unit load) of a product as a Trade Item in its own right (i.e. it is priced, ordered and/or invoiced).

Other companies who have a product that only exists in a single unit load format ("palletisation") may choose to send the palletisation information associated with the highest level of the product hierarchy, typically a case.

Please see section [5.3.2 Step 2 – Select the relevant attributes](#) for further explanation of Platforms and "pallets".

5.1 Pre-Requisites

The supplier supplies the trade item in a standardised layout in a unit load (e.g., on a pallet).

There are two ways to send data about logistics units:

1. The parties involved in the GDSN data synchronisation (data source, data recipient, and their respective data pool(s)) should have the capability to support the attributes for GTIN Logistics Units.
 - **Note:** This is expected, as the attributes are in classes commonly used throughout GDSN.
2. If the parties mutually agree to trade at a level below the logistics unit, then the parties involved in the GDSN data synchronisation (data source, data recipient, and their respective data pool(s)) may choose to have the capability to support the optional module for Non-GTIN Logistics Units.
 - **Note:** This latter capability is optional in GDSN. Without this capability, only a reduced range of attributes may be synchronised for Non-GTIN Logistics Units.

5.2 When Would I Use This?

- The data source intends to send unit load ("palletisation") information in a consistent way in accordance with the GS1 Data Alignment standards.
- Data receivers will be able to integrate unit load information into their system without human intervention.

5.3 How to Populate the Key TI/HI Attributes

5.3.1 Step 1 – Decide whether you can use non-GTIN logistics unit or GTIN logistics unit

1. If a standard logistics unit configuration is ordered, invoiced, or priced, a GTIN needs to be assigned to it.
2. If there are multiple standard logistics unit configurations available for a synchronised item within a target market, a GTIN needs to be assigned to each configuration whether it is ordered, invoiced, or priced or not.
3. Today there are two prevalent business practices for obtaining information when there is only one standard logistics unit configuration in a target market:
 - a. At the logistics unit level when a GTIN is assigned to the logistics unit
 - b. At the “case” level when a GTIN is not assigned to the logistics unit

There are additional attributes that need to be added to support this “case” level processing.

5.3.2 Step 2 – Select the relevant attributes

Terminology

- **GTIN logistics unit (also – wrongly – called GTIN pallet):** A logistics unit that is identified by a GTIN. This GTIN is allocated to the logistics units itself.
- **Non GTIN logistics unit (also – wrongly – called Non-GTIN pallet):** a logistic unit that is not identified by a GTIN. It is actually identified by no Trade Item identifier.
- **Note:** The unit load may be resting on a pallet (a “palletised unit”) or on some other kind of platform, or on no platform. In GDS the supporting device is therefore known as a “platform”, to ensure all Platform Types are included. Section [5.4.6 Example 6](#) explains how to deal with the situation of the Platform Type not being known in advance or where the dimensions of the Unit Load are to be communicated without including the dimensions of the Platform.

Attribute Selection

The following table shows the data attributes which are used to synchronise logistics unit information.

The two options...

- where the logistics unit is also a Trade Item identified by a GTIN
- where the logistics unit is not also a Trade Item and therefore has no GTIN
- ... use different attributes.

Table 5-1 Data Attributes Used to Synchronise Logistics Unit Information

Business requirement	GTIN Logistics Unit scenario	Non-GTIN Logistics Unit scenario The data must be attached to the highest level identified with a GTIN.
† “cases” per layer	Quantity Of Trade Items Contained In A Complete Layer Attribute: <i>quantityOfTradeItemsContainedInACompleteLayer</i> Class: <i>TradeItemHierarchy</i> Module: <i>TradeItemHierarchyModule</i>	Quantity Of Trade Items Per Pallet Layer Attribute: <i>quantityOfTradeItemsPerPalletLayer</i> Class: <i>TradeItemHierarchy</i> Module: <i>TradeItemHierarchyModule</i>

Business requirement	GTIN Logistics Unit scenario	Non-GTIN Logistics Unit scenario The data must be attached to the highest level identified with a GTIN.
layers per logistics unit	Quantity Of Complete Layers Contained In A Trade Item Attribute: <i>quantityOfCompleteLayersContainedInATradeItem</i> Class: <i>TradeItemHierarchy</i> Module: <i>TradeItemHierarchyModule</i>	Quantity Of Layers Per Pallet Attribute: <i>quantityOfLayersPerPallet</i> Class: <i>TradeItemHierarchy</i> Module: <i>TradeItemHierarchyModule</i>
† "cases" per logistics unit	Quantity Of Next Lower Level Trade Item Attribute: <i>quantityOfNextLowerLevelTradeItem</i> Class: <i>ChildTradeItem</i> Module: <i>TradeItem (core)</i>	Quantity Of Trade Items Per Pallet Attribute: <i>quantityOfTradeItemsPerPallet</i> Class: <i>TradeItemHierarchy</i> Module: <i>TradeItemHierarchyModule</i>
logistics unit gross weight	Gross Weight Attribute: <i>grossWeight</i> Class: <i>TradeItemWeight</i> Module: <i>TradeItemMeasurementsModule</i>	Logistics Unit Gross Weight Attribute: <i>grossWeight</i> Class: <i>NonGTINLogisticsUnitInformation</i> Module: <i>NonGTINLogisticsUnitInformationModule</i>
logistics unit height	Height Attribute: <i>height</i> Class: <i>TradeItemMeasurements</i> Module: <i>TradeItemMeasurementsModule</i>	Logistics Unit Height Attribute: <i>height</i> Class: <i>NonGTINLogisticsUnitInformation</i> Module: <i>NonGTINLogisticsUnitInformationModule</i>
logistics unit depth	Depth Attribute: <i>depth</i> Class: <i>TradeItemMeasurements</i> Module: <i>TradeItemMeasurementsModule</i>	Logistics Unit Depth Attribute: <i>depth</i> Class: <i>NonGTINLogisticsUnitInformation</i> Module: <i>NonGTINLogisticsUnitInformationModule</i>
logistics unit width	Width Attribute: <i>width</i> Class: <i>TradeItemMeasurements</i> Module: <i>TradeItemMeasurementsModule</i>	Logistics Unit Width Attribute: <i>width</i> Class: <i>NonGTINLogisticsUnitInformation</i> Module: <i>NonGTINLogisticsUnitInformationModule</i>
stacking factor	* Stacking Factor Attribute: <i>stackingFactor</i> Class: <i>TradeItemStacking</i> Module: <i>TradeItemHandlingModule</i>	Logistics Unit Stacking Factor Attribute: <i>logisticsUnitStackingFactor</i> Class: <i>NonGTINLogisticsUnitInformation</i> Module: <i>NonGTINLogisticsUnitInformationModule</i>
stacking factor type	* Stacking Factor Type Attribute: <i>stackingFactorTypeCode</i> Class: <i>TradeItemStacking</i> Module: <i>TradeItemHandlingModule</i>	<i>No attribute available</i>
platform terms & conditions	* Platform Terms And Conditions Attribute: <i>platformTermsAndConditionsCode</i> Class: <i>PlatformInformation</i> Module: <i>PlatformInformationModule</i>	Platform Terms And Conditions Attribute: <i>platformTermsAndConditionsCode</i> Class: <i>PlatformInformation</i> Module: <i>PlatformInformationModule</i>

Business requirement	GTIN Logistics Unit scenario	Non-GTIN Logistics Unit scenario The data must be attached to the highest level identified with a GTIN.
irregular pallet configuration	* Is Trade Item Packed Irregularly Attribute: <i>isTradeItemPackedIrregularly</i> Class: <i>TradeItemHierarchy</i> Module: <i>TradeItemHierarchyModule</i>	Is Non GTIN Logistic Unit Packed Irregularly Attribute: <i>isNonGTINLogisticsUnitPackedIrregularly</i> Class: <i>TradeItemHierarchy</i> Module: <i>TradeItemHierarchyModule</i>

† Note: Although in most situations, the highest level below the logistics unit may be a case (CA), it may alternatively be another level such as display (DS).

*** Note:** The Stacking Factor, Stacking Factor Type, Pallet Terms and Conditions, Pallet Type Code and Is Trade Item Packed Irregularly are optional. For a particular Trade Item:

- **Either:** they may be unvarying for this Trade Item – if so, they should be passed as master data, populated with the normal values for the Trade Item;
 - **Or:** they may vary for each transaction, for example if there is no “normal” platform used for this Trade Item – if so, they should be passed in the Despatch Advice / Advanced Shipping Notice, and not as master data.
- **Note:** When trade item information does not contain the weight and dimensions of the shipping platform then the Platform Type Code should be populated with Code 27 - Platform of Unspecified Weight or Dimension: The highest level of the hierarchy is being shipped on a shipping platform of unknown dimensions or unknown weight. The platform weight and/or dimension may differ within the same shipment. All other values including null would indicate that the weight and dimensions include the shipping platform.
 - **Note:** Data sources should use only the attributes for the option which applies to the GTIN hierarchy. However, in order to help the transition from past practice, data receivers should not validate for receiving only the appropriate attributes for the selected option. This is because if a supplier transitions a product from non-GTIN logistics units to GTIN logistics units, to enable continuous synchronisation with existing customers, there is often an interim period when only some customers can use the appropriate data attributes. During this interim period data sources may be required to send the data in both levels of the hierarchy (i.e. logistics and the next lower level e.g. case). The data recipient should take the attributes at the first (highest) level of the hierarchy they can process.
 - **Note:** When using the Non-GTIN Logistics Unit option, if one of the following is populated then all must be populated
 - Logistics Unit Gross Weight
 - Logistics Unit Depth
 - Logistics Unit Height
 - Logistics Unit Width
 - Logistics Unit Stacking Factor
 - Platform Terms and Conditions
 - Platform Type Code
 - Quantity Of Layers Per Pallet
 - Quantity Of Trade Items Per Pallet Layer
 - Quantity Of Trade Items Per Pallet

- **Note:** “Packed Irregularly” indicates that the logistics unit is irregularly configured such that “cases per layer” (TI) or “layers per logistics unit” (HI) is not relevant.
- **Note:** Attribute names in the <https://navigator.gs1.org/gdsn/quick-search> **GS1 Navigator, GDSN** and in formal technical documentation are formatted in “CamelCase” as described in Section 2. Those names are also given in [Table 5-1: Data Attributes Used to Synchronise Logistics Unit Information](#).
- **Note:** In the examples which follow, to aid readability the full definitions of the Platform Types Codes are shown in square brackets “[...]” following the codes. For the full list of Platform Type Codes, see the [GS1 Navigator, GDSN](#). For a full explanation of Platform Type Codes, refer to [Section 18: Packaging, Platform Information Module](#).

5.4 Examples

In these examples, the level below the logistics unit is always referred to as a “case”. Although in most situations, the highest level below the logistics unit may be a case (CA), it may alternatively be another level such as display (DS) or pack (PK).

5.4.1 Example 1

A hierarchy in which the highest level of the hierarchy (here a pallet) is identified by a GTIN

The product is a 200g jar of product, packed in cases of 12 jars. The cases are palletised: 8 cases per layer and 4 layers per pallet. The GTINs are:

- jar EA 3033718207536
- case CA 3033710218738
- pallet PL 3033711078317

In GDSN this is published at the highest level of the item hierarchy: **GTIN = 3033711078317**

Table 5-2 Example 1

Information	Data Attribute Name (sent for the pallet GTIN 3033711078317)	sample Value
cases per layer	Quantity Of Trade Items Contained In A Complete Layer	8
layers per logistics unit	Quantity Of Complete Layers Contained In A Trade Item	4
cases per logistics unit	Quantity Of Next Lower Level Trade Item	32
logistics unit gross weight	Gross Weight	299.88 kg
logistics unit height	Height	984 mm
logistics unit depth	Depth	1200 mm
logistics unit width	Width	800 mm
stacking factor	* Stacking Factor	1
stacking factor type	* Stacking Factor Type	<not used>
platform terms & conditions	* Platform Terms And Conditions	<not used>
platform type	* Platform Type Code	11 [ISO 1 Pallet: Flat pallet with dimensions of 1200 x 800 mm as defined in ISO 6780.]

Information	Data Attribute Name (sent for the pallet GTIN 3033711078317)	sample Value
irregular pallet configuration	* Is Trade Item Packed Irregularly	<not used> or FALSE

* Please note: the Stacking Factor, Stacking Factor Type, Platform Terms And Conditions, Platform Type Code and Is Trade Item Packed Irregularly are optional. For a particular Trade Item:

- Either: they may be unvarying for this Trade Item – if so, they should be passed as master data, populated with the normal values for the Trade Item;
- Or: they may vary for each transaction, for example if there is no “normal” platform used for this Trade Item – if so, they should be passed in the Despatch Advice / Advanced Shipping Notice, and not as master data.

5.4.2 Example 2

An example in which the highest level of the hierarchy (here a pallet) is not identified by a GTIN

The product is a 200g jar of product, packed in cases of 12 jars. The cases are palletised: 8 cases per layer and 4 layers per pallet. The GTINs are:

- jar EA 3033718207536
- case CA 3033710218738
- pallet <no GTIN>

In GDSN this is published at the highest level of the item hierarchy: **GTIN = 3033710218738**

Table 5-3 Example 2

Information	Data Attribute Name (sent for the case GTIN 3033710218738)	sample Value
cases per layer	Quantity Of Trade Items Per Pallet Layer	8
layers per pallet	Quantity Of Layers Per Pallet	4
cases per pallet	Quantity Of Trade Items Per Pallet	32
pallet gross weight	Logistics Unit Gross Weight	299.88 kg
pallet height	Logistics Unit Height	984 mm
pallet depth	Logistics Unit Depth	1200 mm
pallet width	Logistics Unit Width	800 mm
stacking factor	Logistics Unit Stacking Factor	1
pallet terms & conditions	Platform Terms And Conditions	2 [Exchange pallet]
platform type	Platform Type Code	11 [ISO 1 Pallet: Flat pallet with dimensions of 1200 x 800 mm as defined in ISO 6780.]
irregular pallet irregular pallet configuration	* Is Non GTIN Logistic Unit Packed Irregularly	<not used> or FALSE

- **Note:** There is no Stacking Factor Type attribute available when using the Non GTIN Logistics Unit approach.

5.4.3 Example 3

¼ or ½ Pallets on Pallet

The product is a bottled water product 8*25 cl multi-pack, packed in cases of 3. The cases are palletised: 54 cases per half pallet and 2 half pallets per pallet. The GTINs are:

- 8 bottles EA 03179730107834
- case CA 03179730107888
- half pallet CA 03179730107765
- pallet PL 03179730107758

Table 5-4 Example 3 (Part 1)

Information	Data Attribute Name (sent for GTIN 03179730107758 (the pallet GTIN))	sample Value
half pallets per layer	Quantity Of Trade Items Contained In A Complete Layer	2
layers per logistics unit	Quantity Of Complete Layers Contained In A Trade Item	1
half pallets per logistics unit	Quantity Of Next Lower Level Trade Item	2
logistics unit gross weight	Gross Weight	1018 kg
logistics unit height	Height	1771 mm
logistics unit depth	Depth	1013 mm
logistics unit width	Width	1268 mm
stacking factor	Stacking Factor	1
stacking factor type	* Stacking Factor Type	<not used>
platform terms & conditions	Platform Terms And Conditions	2 (Exchange Pallet)
platform type	Platform Type Code	12 [ISO 2 Pallet: Flat pallet with dimensions of 1200 x 1000 mm as defined in ISO 6780.]
irregular pallet configuration	Is Trade Item Packed Irregularly	<not used> or FALSE

Table 5-5 Example 3 (Part 2)

Information	Data Attribute Name (sent for GTIN 03179730107765 (the half pallet GTIN))	sample Value
case per layer	Quantity Of Trade Items Contained In A Complete Layer	6
layers per half pallet	Quantity Of Complete Layers Contained In A Trade Item	9
case per half pallet	Quantity Of Next Lower Level Trade Item	54
half pallet gross weight	Gross Weight	488,875 kg
half pallet height	Height	1607 mm
half pallet depth	Depth	1013 mm
half pallet width	Width	634 mm
stacking factor	Stacking Factor	1
stacking factor type	* Stacking Factor Type	<not used>
platform terms & conditions	Platform Terms And Conditions	2 (Exchange Pallet)
platform type	Platform Type Code	31 [1/2 ISO 2 Pallet: Half size flat pallet with dimensions of 1000 x 600 mm .]
irregular pallet configuration	* Is Non GTIN Logistic Unit Packed Irregularly	<not used> or FALSE

Figure 5-2 Example of half-pallet GTIN 03179730107765

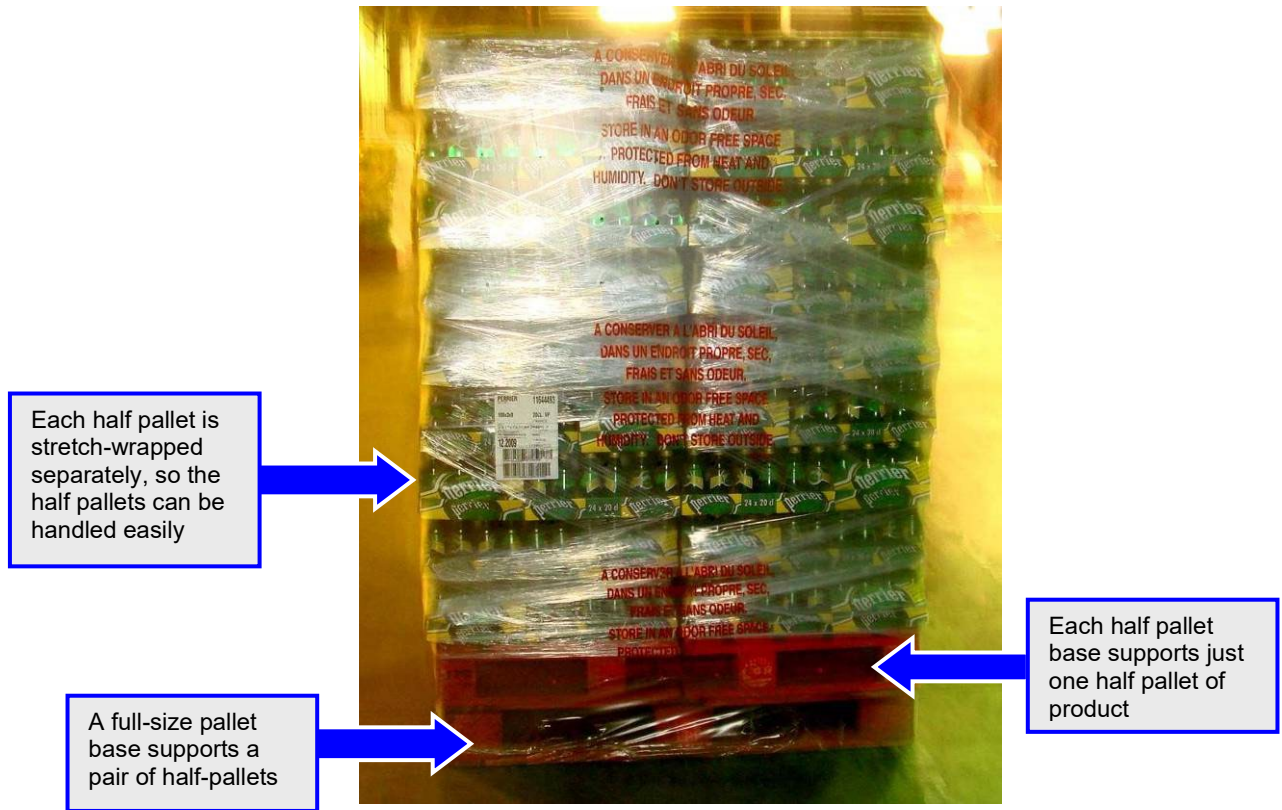

Each half pallet is stretch-wrapped separately, so the half pallets can be handled easily

A full-size pallet base supports a pair of half-pallets

Each half pallet base supports just one half pallet of product

5.4.4 Example 4

Multiple Configurations – GTINs Assigned to Each Configuration

The product is a 200g jar of product, packed in cases of 12 jars. The cases are palletised in two different ways, for different distribution channels. In the first configuration, there are 8 cases per layer and 4 layers per pallet. In the second configuration, there are 10 cases per layer and 6 layers per pallet. The GTINs are:

- jar EA 3033718207536
- case CA 3033710218738
- pallet configuration 1 PL 3033711078317
- pallet configuration 2 PL 3033711078324

In GDSN this is published at the highest level of each item hierarchy: once for **GTIN = 3033711078317** and once for **GTIN = 3033711078324**

Table 5-6 Example 4 (Part 1)

Information	Data Attribute Name (sent for the pallet GTIN 3033711078317)	sample Value
cases per layer	Quantity Of Trade Items Contained In A Complete Layer	8
layers per logistics unit	Quantity Of Complete Layers Contained In A Trade Item	4
cases per logistics unit	Quantity Of Next Lower Level Trade Item	32
logistics unit gross weight	Gross Weight	299.88 kg

Information	Data Attribute Name (sent for the pallet GTIN 3033711078317)	sample Value
logistics unit height	Height	984 mm
logistics unit depth	Depth	1200 mm
logistics unit width	Width	800 mm
stacking factor	* Stacking Factor	1
stacking factor type	* Stacking Factor Type	<not used>
platform terms & conditions	* Platform Terms And Conditions	<not used>
platform type	* Platform Type Code	11 [ISO 1 Pallet: Flat pallet with dimensions of 1200 x 800 mm as defined in ISO 6780.]
irregular pallet configuration	Is Trade Item Packed Irregularly	<not used> or FALSE

Table 5-7 Example 4 (Part 2)

Information	Data Attribute Name (sent for the pallet GTIN 3033711078324)	sample Value
cases per layer	Quantity Of Trade Items Contained In A Complete Layer	10
layers per logistics unit	Quantity Of Complete Layers Contained In A Trade Item	6
cases per logistics unit	Quantity Of Next Lower Level Trade Item	60
logistics unit gross weight	Gross Weight	547.28 kg
logistics unit height	Height	1422 mm
logistics unit depth	Depth	1200 mm
logistics unit width	Width	1000 mm
stacking factor	* Stacking Factor	1
stacking factor type	* Stacking Factor Type	<not used>
platform terms & conditions	* Platform Terms And Conditions	<not used>
platform type	* Platform Type Code	12 [ISO 2 Pallet: Flat pallet with dimensions of 1200 x 1000 mm as defined in ISO 6780.]
irregular pallet configuration	Is Trade Item Packed Irregularly	<not used> or FALSE

*Note: the **Stacking Factor**, **Platform Terms and Conditions** and **Platform Type Code** are optional. For a particular Trade Item:

- Either: they may be unvarying for this Trade Item – if so, they should be passed as master data, populated with the normal values for the Trade Item;
- Or: they may vary for each transaction, for example if there is no “normal” platform used for this Trade Item – if so, they should be passed in the Despatch Advice / Advanced Shipping Notice, and not as master data.

5.4.5 Example 5

Moving from example 2 to example 1. From Non GTIN logistics units to GTIN logistics units.

In this scenario, the original publication occurred at the case level **GTIN = 3033710218738** (Section [5.4.2](#)).

Now the manufacturer has decided to trade at the pallet level, perhaps because they created another logistics unit configuration. Because there will then be two concurrent logistics unit configurations, the manufacturer will need to assign GTINs to the pallet level for each configuration (Section [5.4.4](#)).

The recommended process is as follows:

1. Assign a GTIN and create a record for the new pallet, indicating the existing case as the Next Lower Level GTIN
 2. Publish a new item to the retailer for the new configuration, publishing at the pallet level
 3. Send a **Change** for the existing case record, removing the non-GTIN logistics attributes
 4. The retailer now has two publications, one at the pallet level and the other at the case level
 5. The retailer will need to send a positive CIC for the new pallet configuration and a rejected CIC for the case configuration
 6. The supplier can later send a **Publication** delete for the case if it is no longer offered to the retailer
 7. The records can contain the appropriate ordering true/false flags, depending upon the configuration and the retailer
- **Note:** This process is designed to avoid sending a **Delete** message which might be confusing to the data receiver.
 - **Note:** The technical details of how this is achieved using standard messages between data pools within the GDSN is more complex. For further details, users may also obtain advice from their home Data Pool and/or from any GS1 Member Organisation.

5.4.6 Example 6

Unspecified Platform Weight & Dimensions

The example is similar to the first example. In this situation, the weights and dimensions will not include the weight and height of the pallet platform itself.

The product is a 200g jar of product, packed in cases of 12 jars. The cases are palletised: 8 cases per layer and 4 layers per pallet. The GTINs are:

- jar EA 3033718207536
- case CA 3033710218738
- pallet PL 3033711078324

In GDSN this is published at the highest level of the item hierarchy: **GTIN = 3033711078324**

Assume that in Example 1 the platform itself, without any goods on it, was measured at 25kg gross weight and 150mm high. In this example, because we do not know what type of platform will be used, the Gross Weight and Height are adjusted to remove the gross weight and height of the platform from the gross weight and height of the trade item.

Table 5-8 Example 6

Information	Data Attribute Name (sent for the pallet GTIN 3033711078324)	sample Value
cases per layer	Quantity Of Trade Items Contained In A Complete Layer	8
layers per logistics unit	Quantity Of Complete Layers Contained In A Trade Item	4
cases per logistics unit	Quantity Of Next Lower Level Trade Item	32
logistics unit gross weight	Gross Weight	274.88 kg (= 299.88 - 25)
logistics unit height	Height	834 mm (= 984 - 150)
logistics unit depth	Depth	1200 mm
logistics unit width	Width	800 mm
stacking factor	* Stacking Factor	1
stacking factor type	* Stacking Factor Type	<not used>
platform terms & conditions	* Platform Terms And Conditions	<not used>
platform type	* Platform Type Code	27 [Platform of Unspecified Weight or Dimension.]
irregular pallet configuration	* Is Trade Item Packed Irregularly	<not used> or FALSE

* Please note: the **Stacking Factor, Platform Terms and Conditions, Platform Type Code** and **Is Trade Item Packed Irregularly** are optional. For a particular Trade Item:

- Either: they may be unvarying for this Trade Item – if so, they should be passed as master data, populated with the normal values for the Trade Item;
- Or: they may vary for each transaction, for example if there is no “normal” platform used for this Trade Item – if so, they should be passed in the Despatch Advice / Advanced Shipping Notice, and not as master data.
- **Note:** When the Platform Type is unknown, or it is necessary to send the weight and dimensions of the pallet without including the weight and dimensions of the pallet platform itself, it is recommended to use Platform Type Code “27”:

Platform of Unspecified Weight or Dimension: Pallet level hierarchy is being shipped on a shipping platform of unknown dimensions or unknown weight. The platform weight and/or dimension may differ within the same shipment. All other values including null would indicate that the weight and dimensions include the shipping platform.

All other Platform Types require the weight and dimensions of the pallet platform itself to be included in the weight and dimensions of the Trade Item.

5.4.7 Example 7

A Logistics Unit with an Irregular Configuration

Some unit loads, such as some palletised loads, are stacked irregularly. This can be done in order to get greater strength and stability during transport, by interlocking cases in irregular patterns. However this means it is not possible to give the “cases per layer” (TI) or “layers per logistics unit” (HI) because it can be different on each layer, and even the layers can be interlocking. As a result, only the total number of the next level trade item (e.g. cases on a pallet) can be specified. However, some Data Recipients’ systems rely upon a value in both attributes. If provided, the highest value should be given. If the number of “cases per layer” (TI) varies, give the highest possible number of

cases on a single layer. If the number of “layers per logistics unit” (HI) varies, give the highest possible number of layers on the logistics unit.

The indicator attribute isTradeItemPackedIrregularly alerts the Data Recipient to switch off any check that the product of the two attributes (TI x HI) equals the total number of trade items in the unit load.

To see how this works, consider this example. The product is in a large rectangular case. The cases are arranged in alternate layer patterns on the pallet platform, for greater stability. The first layer pattern provides for 8 cases in a layer, but the second layer pattern provides space for only 6 cases per layer. There are only two layers, giving a total of 14 cases on the pallet.

Figure 5-3 Logistics Unit with Irregular Configuration

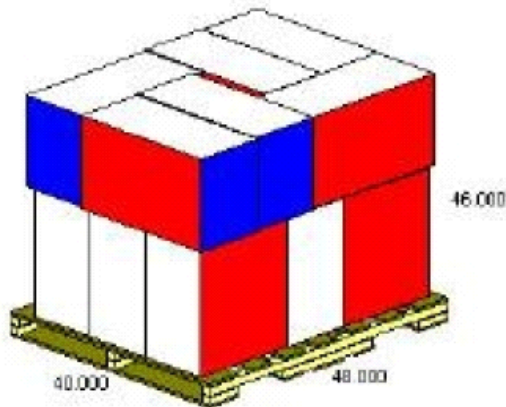

40 x 48.0 GMA Pallet	Pallet:	40 x 48.0 Tarima estandar
Tools per Unit	1	Herramientas por caja
Units per Layer	8, 6	Cajas por nivel
Number of Layers	2	Niveles por pallet
Units per Pallet	14	Unidades por Pallet
Tools per Pallet	14	Herramientas por Pallet
Notes / Notas: 8 units on bottom layer, 6 units on top layer.		

The GTINs are:

product in case EA 7601234567890
pallet PL 7601234567883

In GDSN this is published at the highest level of the item hierarchy: **GTIN = 7601234567883**

Table 5-9 Example 7

Information	Data Attribute Name (sent for the pallet GTIN 7601234567883)	sample Value
cases per layer	Quantity Of Trade Items Contained In A Complete Layer	8
layers per logistics unit	Quantity Of Complete Layers Contained In A Trade Item	2
cases per logistics unit	Quantity Of Next Lower Level Trade Item	14
logistics unit gross weight	Gross Weight	252.34 kg
logistics unit height	Height	1160 mm
logistics unit depth	Depth	1219 mm
logistics unit width	Width	1016 mm
stacking factor	* Stacking Factor	1
stacking factor type	* Stacking Factor Type	<not used>
platform terms & conditions	* Platform Terms And Conditions	<not used>
platform type	* Platform Type Code	40 [ISO 3 Pallet: Flat pallet with dimensions of 1219 x 1016 mm (48 x 40 In) as defined in ISO 6780.]
irregular pallet configuration	* Is Trade Item Packed Irregularly	TRUE

* Please note: the Stacking Factor, Platform Terms And Conditions, Platform Type Code and Is Trade Item Packed Irregularly are optional. For a particular Trade Item:

- Either: they may be unvarying for this Trade Item – if so, they should be passed as master data, populated with the normal values for the Trade Item;
 - Or: they may vary for each transaction, for example if there is no “normal” platform used for this Trade Item – if so, they should be passed in the Despatch Advice / Advanced Shipping Notice, and not as master data.
- **Note:** “Packed Irregularly” indicates that the logistics unit is irregularly configured such that
 - either “cases per layer” (TI) or “layers per logistics unit” (HI) is not relevant;
 - if both “cases per layer” (TI) or “layers per logistics unit” (HI) are provided, then the product of them (TI x HI) will not equal the total number of cases in the unit load.
 - **Note:** This example uses attribute *isTradeItemPackedIrregularly* because the GTIN is for the pallet. If there is no GTIN at pallet level, and the NonGTIN Logistics Unit approach is taken (similar to Example 2), use attribute *isNonGTINLogisticsUnitPackedIrregularly* at the highest level below the logistics unit, typically a Case or Display. Only use the Each if there is no higher GTIN in the GTIN hierarchy.

5.5 Notes

5.5.1 Tip on Attribute Names

An easy way to remember which attribute to use is:

"If the attribute name contains the words "Per Pallet" the attribute should NEVER be used when synchronising the Pallet GTIN, only when synchronising the non-GTIN Pallet."

5.5.2 Stacking Factor

The stacking factor will indicate how many levels the particular product may be stacked in. The counting of the levels will always commence at 1 not 0.

For example:

- Stacking Factor = "1" means "non stackable".
- Stacking Factor = "2" means “trade item is stackable 2 high”.

The stacking factor is intended to be used in warehouse applications. If the stacking factor for a transport operation is required, see the note on Stacking Factor Type, below.

- **Note:** For a GTIN Logistics Unit (“GTIN pallet”) use attribute Stacking Factor.
For a Non-GTIN Logistics Unit (“non-GTIN pallet”) use attribute Logistics Unit Stacking Factor.

5.5.3 Stacking Factor Type

The stacking factor may occasionally vary as a consequence of the way the items are handled in different forms of transport, or while in the warehouse. Use the optional Stacking Factor Type to show the supply chain process that the particular product may be stacked in. From a supply chain perspective these values can differ from a storage perspective, truck transport, rail, etc. If a retailer is shipping between warehouses or store, they need the information to support their supply chain. For example the item may be stacked only 2 pallets high in a truck, but in a warehouse that can be 3 pallets high.

For example:

- Trade Item Stacking 1
 - Stacking Factor Type Code = "TRANSPORT_ROAD" means "Applicable for goods being transported by road"
 - Stacking Factor = "2" means "trade item is stackable 2 high".
- Trade Item Stacking 2
 - Stacking Factor Type Code = "STORAGE_UNSPECIFIED" means "Applicable for goods in storage, irrespective of type of storage"
 - Stacking Factor = "3" means "trade item is stackable 3 high".

If no Stacking Factor Type Code is specified, it is assumed that the Stacking Factor is intended to be used in warehouse applications.

- **Note:** For a GTIN Logistics Unit ("GTIN pallet") use attribute Stacking Factor Type Code. It is not currently foreseen to require different Stacking Factors for Non-GTIN Logistics Units ("non-GTIN pallets"), so there is no attribute Logistics Unit Stacking Factor Type Code.

6 Discontinue a Trade Item

This section defines how to discontinue a Trade Item.

- ✓ **Note:** The standards on the non-resuse of GTINs are contained in the [GS1 General Specifications](#)

6.1 Why are Trade Items Discontinued

Trade items may be discontinued for various reasons. Some examples are listed below:

- Manufacturer permanently discontinues a trade item due to decreased demand or introduction of new and improved version of the product.
- Manufacturer sells off a brand to another company so they discontinue the item from their product offering
- Manufacturer temporarily discontinues a trade item because it is seasonal

6.2 What is the Difference between Discontinuing a Trade item vs. Cancelling a Trade Item?

- Manufacturers use the discontinue process when the item is being traded within the marketplace
- Manufacturers may register a GTIN, but then determine they will not manufacture the item so they can set a cancel date

6.3 Pre-Requisite

When discontinuing a Trade Item, use the following attributes from the GS1 Navigator, GDSN:

- [Discontinued Date](#) – Communicate the date on which the trade item is no longer to be manufactured.
- [Last Order Date](#) – Indicates the latest date that an order can be placed for the trade item.

6.4 How to Discontinue a Trade Item

The following business scenarios illustrate the process for a manufacturer to discontinue a Trade Item – permanently and temporary (including seasonal).

6.4.1 Scenario 1 – Permanently Discontinue a Trade Item

Executive Summary

In this scenario, a supplier decides to permanently remove an item from the supply chain. This involves creating a discontinued date in the Global Registry which is used to trigger and track the retention period. The retention period is a time period when the GTIN cannot be reused.

- **Note:** It is not necessary to send both a discontinued date and last order date. If only one date is sent, last order date should be the primary date.
- 1. On 30-Apr-2005, a supplier decides to permanently discontinue an item effective 30-Jun-2005. The item is registered in a single Target Market.
- 2. The supplier communicates the discontinued date of 30-Jun-2005 to their Source Data Pool (SDP).
- 3. On 30-Jul-2005, the supplier anticipates they will have inventory available to ship until 30-Sep-2005. They send a last order date of 30-Sept-2005 to their SDP.
- 4. On 30-Oct-2005, the supplier has depleted their inventory of the discontinued product. They send a publication delete to their SDP for all data recipients who are in sync on the item. The publication delete stops the synchronization process and disallows visibility of the catalogue item.
- **Note:** For more details on messaging passed between data pools please see the *Catalogue Item Synchronisation BMS*.

Detailed Use Case

In this scenario, a supplier decides to permanently remove an item from the supply chain. This involves creating a discontinued date in the Global Registry which is used to trigger and track the retention period. The retention period is a time period when the GTIN cannot be reused.

- **Note:** An Information Provider (IP) may not elect to send Discontinued and **Last Order Date**. If an IP only sends one of the dates **Last Order Date** should be the primary date.
- 1. On 30-Apr-2005 an Information Provider decides to permanently discontinue an item as of 30-June-2005. The item is registered in 1 TM.
- 2. The IP communicates the discontinued date of 30-June-2005 to their Source Data Pool (SDP). The IP may also elect to send **Last Order Date** at this time.
- 3. The SDP sends a **CHANGE_BY_REFRESH** RCIR to the GS1 Global Registry with a Discontinued Date. The Item State at SDP is "**Registered**".
- 4. The SDP sends a **CHANGE_BY_REFRESH** CIN to Recipient Data Pool (RDP) and the data recipients (that the IP has published the item hierarchy to) and have not rejected it. The CIN contains the Discontinued Date of 30-Jun-2005. Item State is "**Registered**".
- 5. On 30-Jun-2005 the item state in GS1 Global Registry SDP is changed to "**Discontinued**".
- 6. On 30-July-2005 the manufacturer anticipates they will have inventory available to ship until Sept.30, 2005. They send a **Last Order Date** of 30-Sept-2005 to their SDP. SDP then sends a **CHANGE_BY_REFRESH** CIN to RDP and data recipients (that the IP has published the item hierarchy to) and has not rejected it. The CIN contains the Last Order Date of 30-Sept-2005. Item State is "**Discontinued**".
- 7. On 30-Oct-2005 an IP has depleted their inventory. On 10-Nov-2005 IP determines they will no longer have any changes to the item hierarchy. They send a publication delete, Catalogue Item Publication – Delete (CIP Delete), to their SDP for all data recipients who have received the item hierarchy publication and have not yet rejected it.

8. SDP sends a **DELETE** CIN to RDP and all data recipients who have received the item hierarchy publication and have not yet rejected it. SDP removes item hierarchy from the synchronization list. The data recipients will no longer receive updates for this item.
9. On 30-Jun-2009 GS1 deletes the item from the GS1 Global Registry (48 months).
 - **Note:** If item is apparel it will be deleted on 30-Dec-2008 (30 months).
 - **Note:** Deletion from the registry is based upon timing established by applicable industry guidelines according to the GS1 standards as published in the [GS1 General Specification](#).
 - **Note:** Deletion cannot happen until all registrations for a GTIN have been marked with a discontinue date and applicable time window has passed. To finalize the deletion process, a communication needs to occur between the GR and the SDPs involved. This process is under development and will be added here once complete.
10. Once notified of the GR deletion, the SDP validates that all publications and links have been deleted and then deletes the GTINs from the SDP.
 - **Note:** Until further notice the Information Provider (IP) will have to activate the deletion by contacting the SDP and that the IP is responsible for assuring that the GTIN is not actively sold anymore anywhere in the world

6.4.2 Scenario 2 – Temporarily Discontinue a Trade Item

Executive Summary

In this scenario a supplier decides to temporarily discontinue an item from the supply chain, such as seasonal products. This involves communicating a last order date to their retailers when they temporarily discontinue the item. When the supplier is reinstating the item in the supply chain they would send an updated first order date.

1. On 30-Apr-2005, a supplier decides to temporarily discontinue an item as of 30-Jun-2005. The item is registered in a single Target Market.
 2. The supplier communicates the last order date of 30-June-2005 to their Source Data Pool (SDP).
 3. The supplier intends to offer this product for sale beginning 01-Jan-2006. On 01-Dec-2005 the supplier communicates the first order date of 11-Jan-2006 and the removal of the last order date to their SDP.
- **Note:** For more details on messaging passed between data pools please see the [Catalogue Item Synchronisation BMS](#).

Detailed Use Case

In this scenario a supplier decides to temporarily discontinue an item from the supply chain, such as a seasonal product. This involves communicating a last order date to their retailers when they temporarily discontinue the item. When the supplier is reinstating the item in the supply chain they would send an updated first order date.

1. 30-Apr-2005 an Information Provider (IP) decides that they will temporarily discontinue an item as of 30-Jun-2005 (assumes the item is seasonal). The item is registered in 1 TM.
2. IP sends Last Order Date of 30-Jun-2005 to the SDP
3. SDP sends a **CHANGE_BY_REFRESH** CIN to the RDP and the data recipients to whom the IP has published the item hierarchy and who have not rejected it. The CIN contains **the Last Order Date** of 30-Jun-2005. Item State is **“Registered”**

4. On 01-Dec-2005 the IP sends the SDP a **First Order Date** of 01-Jan-2006 and nulls the **Last Order Date**.
5. The SDP sends a **CHANGE_BY_REFRESH** CIN to RDP and all data recipients who have received the item hierarchy publication and have not yet rejected it with the **First Order Date** of 01-Jan-2006 and null **Last Order Date**.

6.4.3 Scenario 3 – Continue Manufacturing a Trade Item After a Discontinue Date Has Been Set

Executive Summary

In this scenario, a supplier decides to continue manufacturing an item after they have set the discontinue date. This involves removing the discontinue date from the Global Registry prior to the discontinue date being reached.

1. On 30-Apr-2005, a supplier decides to permanently discontinue an item as of 30-Jun-2005. The item is registered in a single Target Market.
2. The supplier communicates the discontinue date of 30-Jun-2005 to their Source Data Pool (SDP).
3. On 30-May-2005 an IP decides to continue manufacturing item and communicates to their SDP the removal of the discontinue date.

- **Note:** For more details on messaging passed between data pools please see the [Catalogue Item Synchronisation BMS](#).

Detailed Use Case

In this scenario, a supplier decides to continue manufacturing an item after they have set the discontinue date. This involves removing the discontinue date from the Global Registry so prior to the discontinue date being reached

1. 30-Apr-2005 an Information Provider (IP) decides that they will permanently discontinue an item as of 30-Jun-2005. The item is registered in 1 TM.
2. The IP communicate the discontinue date of 30-Jun-2005 to their Source Data Pool (SDP)
3. The SDP sends a **CHANGE_BY_REFRESH** RCIR to the GS1 Global Registry with the Discontinue Date of 30-Jun-2005. Item State at the SDP is "**Registered**"
4. The SDP sends a **CHANGE_BY_REFRESH** CIN to RDP and data recipients (that the IP has published the item hierarchy to) and have not rejected it. The CIN contains the Discontinue Date of June 30, 2005. Item State is "Registered"
5. On 30-May-2005 an IP decides to continue manufacturing item. The IP the sends a **CORRECT** to their SDP with the Discontinue Date nulled out.
6. The SDP sends a **CORRECT** RCIR to GS1 Global Registry, which then nulls out Discontinue Date.
7. The SDP sends a **CORRECT** CIN to RDP and data recipients (that the IP has published the item hierarchy to) and have not rejected it. The CIN has nulled out Discontinue Date. The Item State is "**Registered**".

7 Variable Measure Products (Non-Food)

This section addresses non-food variable measure trade items. Examples include but are not limited to the following types of products: rope, chain, wire, carpet, vinyl flooring, fabric, etc... These types of trade items are commonly referred to as "bulk" items in the Hardlines industry.

The [GS1 General Specifications](#) provides the following information regarding fixed and variable measure trade items define variable measure trade items as "Any trade item of a given composition

where the quantity/measure information cannot be predetermined for any reason is a Variable Measure Trade Item.

Fixed Measure Trade Items are those that are always produced in the same version and composition (e.g., type, size, weight, contents, and design). Like a Fixed Measure Trade Item, a Variable Measure Trade Item is an entity with pre-defined characteristics, such as the nature of the product or its contents. Unlike a Fixed Measure Trade Item, a Variable Measure Trade Item has at least one characteristic that varies whilst other characteristics of the trade item remain the same. The variable characteristic may be weight, dimension, number of items contained, or volume information. The complete identification of a Variable Measure Trade Item consists of both an identification number and information about the variable data.

7.1 Pre-Requisite

Trade item is determined to be a non-food variable measure trade item.

7.2 When Would I Use This?

These guidelines are to be used when synchronising a non-food variable measure trade items.

7.3 How To?

This section describes several procedures associated with Variable Measure Products (Non-Food).

7.3.1 Product that is fixed at the Despatch Unit Level and Variable at the Consumer Unit Level

Example: Spool of wire, which has fixed dimensional attributes (quantity/measure information) at the despatch unit and can be sold either as the spool or pieces cut from the spool.

Section [7.3.2](#) and Section [7.3.3](#) describe two different scenarios on how the product may be set up depending on the industry and/or trading relationship.

7.3.2 Scenario A

Despatch Unit Level is identified as a Trade Item; the Consumer Unit Level is not identified as a Trade Item

In this scenario:

- The Despatch Unit is traded (from supplier to retailer) and must be identified with a GTIN
- The retailer may decide to sell the entire spool or pieces cut from the spool, the supplier does not assign a GTIN for the piece cut from the spool
- There is only a single Trade Item to be synchronised and it identifies the complete spool of wire

The table below is an example of how to populate the attributes.

GTIN	00123456789111
tradeItemDescription	Brand X wire, 10 gauge
tradeItemUnitDescriptorCode	CASE
additionalTradeItemIdentification	123456789111
isBarCodeDerivable	TRUE
netContent + UoM	250 ft
OrderingUnitOfMeasure	ft
SellingUnitOfMeasure	ft
isTradeItemABaseUnit	TRUE
isTradeItemAConsumerUnit	TRUE or FALSE

GTIN	00123456789111
isTradeItemAnOrderableUnit	TRUE
isTradeItemADespatchUnit	TRUE
isTradeItemAnInvoiceUnit	TRUE
isTradeItemAVariableUnit	FALSE
additionalTradeItemIdentification /TypeCode	Additional instances could be used if there is a common PLU (Product Lookup) assigned within an industry

- **Note:** Net Content must be populated so the retailer will be able to know how many potential consumer units are contained in the bulk item.
- **Note: *IsTradeItemAConsumerUnit*** may be set to True or False by the supplier based on how the item will be generally sold to the end consumer. If the item is intended to cross point-of-sale then it must be barcoded with a barcode that can be scanned at point-of-sale.

7.3.3 Scenario B

Both the Despatch Unit Level and the Consumer Unit Level are identified as Trade Items

In this scenario:

- The Despatch Unit is traded (from supplier to retailer) and must be identified with a GTIN
- The retailer may decide to sell the entire spool or pieces cut from the spool, the supplier decides to assign a GTIN for the piece cut from the spool and communicates this GTIN to the retailer
- The Trade Item Hierarchy will consist of two GTINs: the fixed-measure despatch unit level (identifying the complete spool of wire) and the variable-measure consumer unit level (identifying the length of wire cut from the spool)

Table 7-2 and 7-3 are examples of how to populate the attributes.

Table 7-1 Despatch Unit GTIN

GTIN	00123456789111
tradeItemDescription	Brand X wire, 10 gauge
tradeItemUnit Descriptor	CASE
additionalTradeItemIdentificationType	UP
additionalTradeItemIdentificationCode	123456789111
isBarCodeDerivable	TRUE
netContent + UoM	250 ft
totalQuantityOfNextLowerLevelTradeItem	250
OrderingUnitOfMeasure	ft
SellingUnitOfMeasure	ft
isTradeItemABaseUnit	FALSE
isTradeItemAConsumerUnit	TRUE or FALSE
isTradeItemAnOrderableUnit	TRUE
isTradeItemADespatchUnit	TRUE
isTradeItemAnInvoiceUnit	TRUE
isTradeItemAVariableUnit	FALSE

GTIN	00123456789111
additionalTradeItemIdentification /TypeCode	Additional instances could be used if there is a common PLU (Product Lookup) assigned within an industry

- **Note: IsTradeItemAConsumerUnit** may be set to True or False by the supplier based on how the item will be generally sold to the end consumer. If the item is intended to cross point-of-sale then it must be barcoded with a barcode that can be scanned at point-of-sale.

Table 7-2 Consumer Unit GTIN

GTIN	00123456799998
tradeItemDescription	Brand X wire, 10 gauge
tradeItemUnitDescriptor	BASE_UNIT_OR_EACH
additionalTradeItemIdentificationType	UP
additionalTradeItemIdentificationCode	123456789111
isBarCodeDerivable	FALSE
netContent + UoM	1 ft
OrderingUnitOfMeasure	N/A
SellingUnitOfMeasure	ft
isTradeItemABaseUnit	TRUE
isTradeItemAConsumerUnit	TRUE
isTradeItemAnOrderableUnit	FALSE
isTradeItemADespatchUnit	FALSE
isTradeItemAnInvoiceUnit	FALSE
isTradeItemAVariableUnit	TRUE
additionalTradeItemIdentification /TypeCode	Additional instances could be used if there is a common PLU (Product Lookup) assigned within an industry

- **Note:** In these types of products the consumer pays for the exact amount that they purchase.

7.3.4 Product that is Variable at both Despatch Unit Level and Consumer Unit Level

Example: A roll of carpet or vinyl flooring that does not have a fixed measure at the despatch unit and has pieces cut from the roll in varying quantities for sale to the consumer. The unit of measure at the consumer level is typically different.

Treat these types of products as variable measure non-consumer trade items. Use **CASE** as the Trade Item Unit Descriptor. There is only a single Trade Item to be synchronised and it identifies the despatch unit (the complete roll of carpet in the example below)

The table below is an example of how to populate the attributes.

GTIN	90123457789113
tradeItemDescription	Brand Y, carpet, plush
tradeItemUnitDescriptor	CASE
additionalTradeItemIdentificationType	UK
additionalTradeItemIdentificationCode	90123457789113
isBarCodeDerivable	TRUE

GTIN	90123457789113
netContent + UoM	300 sy
OrderingUnitOfMeasure	sy
SellingUnitOfMeasure	sy
isTradeItemA BaseUnit	TRUE
isTradeItemAConsumerUnit	FALSE
isTradeItemAnOrderableUnit	TRUE
isTradeItemADespatchUnit	TRUE
isTradeItemAnInvoiceUnit	TRUE
isTradeItemAVariableUnit	TRUE
additionalTradeItemIdentification /TypeCode	Additional instances could be used if there is a common PLU (Product Lookup) assigned within an industry

- **Note:** Net Content must be populated so the retailer will be able to know how many potential consumer units are contained in the bulk item.
- **Note:** Because the exact net content is not known, the supplier will provide the minimum net content.

8 Metric and Imperial Measurements

In trade, most countries use the metric system of measurements, but some prefer the imperial system of measurements. This guideline illustrates how such measurements should be passed in GDSN.

8.1 Pre-Requisite

The data source provides information on a trade item in more than one target market with more than one measurement system.

In each target market, the data source has determined which measurement system is required.

- **Note:** Please see [GS1 Package and Product Measurement Standard](#)
- **Note:** Most commonly the US-imperial measurement system is used in the USA; the metric system is most commonly used in other target markets; the final decision rests with the data source.

8.2 When Would I Use This?

For all global measurement attributes (listed in section [8.3](#)), Data Sources require the ability to send either ,metric or imperial measurements, depending on the Target Market. For each Target Market, there will be only one value, as determined by the Data Source. The Data Source should provide the measurement system that is required in a specific target market.

- **Important:** In the event there is a regulatory framework requiring a particular unit of measure, it is the data recipient’s responsibility to ensure that local regulations are adhered to.

8.3 Attributes in scope

The data source in each target market can provide only one value for weights, dimensions and temperatures. The following attributes represent a sample of where this would apply.

- batteryWeight
- characteristicValue
- depth
- diameter
- drainedWeight
- flammableGasWeight
- flashPointTemperature
- grossWeight
- height
- inBoxCubeDimension
- individualUnitMaximumSize
- individualUnitMinimumSize
- LogisticsUnitWeightAndDimension -Depth
- LogisticsUnitWeightAndDimension -GrossWeight
- LogisticsUnitWeightAndDimension- Width
- LogisticsUnitWeightAndDimension-Height
- nestingIncrement
- netWeight
- nominalInsideDiameter
- nominalOutsideDiameter
- organismMaximumValue
- pegHorizontal
- pegVertical
- priceComparisonMeasurement
- productYield
- quantityContained
- servingSize
- stackingWeightMaximum
- variableWeightRangeMaximum
- variableWeightRangeMinimum
- width

8.3.1 Business Rules

Suppliers may use any valid unit of measure (UOM) and it is up to their trading partners to convert the UOM between increments within a measurement system (e.g. millimetres versus centimetres, pounds versus ounces, or inches versus feet).

- **Note:** For those attributes that have code lists specified in the Business Message Standard, always use a valid value from the code list specified.
- **Note:** For more information, please see [GS1 Package and Product Measurement Standard](#).

If a Data Source uses the same measurement system for the same attribute in more than one Target Market, then the Data Source must take care to ensure that values are consistent (e.g. if sending Depth to both France and Germany in the metric system, it is acceptable to send 100 mm to one and 10 cm to the other).

- **Important:** The GTIN Management Standard must always be followed.

For those attributes which do not change when a trade item crosses a border between a “metric” country and an “imperial” country, such as handling temperatures, it is expected that the data source would take care to ensure approximate consistency between the two measurement systems. This cannot be validated by the Network, so it remains the responsibility of the data source to ensure this happens.

8.3.2 Attributes not in Scope

For information, some attributes are excluded from this guideline. The table below gives some example attributes a short explanation why. This list is subject to change.

Attribute	Reason
freeQuantityOfNextLowerLevelTradeItem	Similar to NetContent, could require multiple values within Target Market
freeQuantityOfProduct	Similar to NetContent, could require multiple values within Target Market
IngredientStrength	Already Global/Local or Local so can vary by Target Market
goodsPickUpLeadTime	Already Global/Local or Local so can vary by Target Market
netContent	Rules for netContent are different and referenced here. Note: See <i>Populating Net Content</i> topic for more information.
orderingLeadTime	Already Global/Local or Local so can vary by Target Market
orderSizingFactor	Already Global/Local or Local so can vary by Target Market
packagingMaterialCompositionQuantity	Already Global/Local or Local so can vary by Target Market
tradeItemCompositionWidth	Expressed as count
unitsPerTradeItem	Expressed as count

- **Note:** All attributes of types Percentage, Count and Time are out of scope because these units do not vary between the measurement systems.

9 Trade Item Weight

This section describes how to work with Net Weight and Gross Weight in the GS1 Global Data Synchronisation Network (GDSN). Net Weight is the weight of the trade item not including any packaging. Gross Weight is the weight of the trade item including packaging. This guideline will clarify how this applies to several example products.

9.1 Pre-Requisite

The data source must know the following:

- Net weight of the item(s) at appropriate levels of the Trade Item Hierarchy
- Gross weight of the item(s) at all levels of the Trade Item Hierarchy
- Total Quantity Of Next Lower Level Trade Item for each level of the Trade Item Hierarchy

9.2 When Would I Use This?

Net weight is optional on all levels of the hierarchy. It may be requested by data recipients in specific target markets or industries.

For some products the net weight and the net content may be the same value: for example, a 200 gram bag of chocolates.

- **Note:** Net Content can be expressed in any valid unit of measure, including weight or volume or count, and so on. Where Net Content is not expressed as a weight, data sources may wish to send a Net Weight, although the standard does not require this.
- **Note:** It is up to the data source to decide when to use net weight. This guideline is intended to describe how to calculate the data value.
- **Note:** If a data source declares multiple Net Contents, there will be no impact to Net Weight.

9.3 Validation Rule for Gross Weight

For a physical trade item, a validation rule is in place to assist recipient’s downstream processes. Processes such as movements of partial shipping units, self-checkouts, and etc. require gross weight information at all levels of a hierarchy. This ensures that the information is available for those processes.

9.4 How to Calculate the Net Weight?

There are three examples of simple hierarchies:

Pallet → Case → Each

...with packaging at all three levels. The examples show how to calculate the Net Weight and the Gross Weight at all three levels.

- **Note:** Net Weight excludes packaging at all levels. This means the packaging of the lowest level GTIN is excluded from the net weight of all levels of GTINs. The difference between the Gross Weight and Net Weight at any level in the Trade Item Hierarchy is therefore the total weight of packaging at all levels up to and including that level.

9.4.1 Example in Metric Measure – Net Content Expressed as Weight

For the each, there is a Net Content of 200g and packaging weighing 470g.

For the case, there is 0.5 kg of extra packaging, in addition to the packaging on the Eaches.

For the pallet, there is 24 kg of extra packaging, in addition to the packaging on the Cases and Eaches.

GTIN	Trade Item Unit Descriptor	Total Quantity Of Next Lower Level Trade Item	Net Measurement				Gross Measurement	
			Net Content	Net Content UoM	Net Weight	Net Weight UoM	Gross Weight	Gross Weight UoM
07612345678924	Pallet	96			230.4	KG	843.84	KG
07612345678917	Case	12			2.4	KG	8.54	KG
07612345678900	Each	n/a	200	GR			670	GR

9.4.2 Example in Metric Measure – Net Content Expressed as Volume

For the each, there is a Net Content of 500 ml (which weighs 427g), and packaging weighing 25g.

For the case, there is 0.8 kg of extra packaging, in addition to the packaging on the Eaches.

For the pallet, there is 30 kg of extra packaging, in addition to the packaging on the Cases and Eaches.

GTIN	Trade Item Unit Descriptor	Total Quantity Of Next Lower Level Trade Item	Net Measurement				Gross Measurement	
			Net Content	Net Content UoM	Net Weight	Net Weight UoM	Gross Weight	Gross Weight UoM
05012345678924	Pallet	168			573.888	KG	771.888	KG
05012345678917	Case	8			3.416	KG	4.416	KG
05012345678900	Each	n/a	500	ML			452	GR

9.4.3 Example in Imperial Measure – Net Content Expressed as Weight

For the each, there is a Net Content of 1 pound and packaging weighing 0.2 pounds.

For the case, there is 1 pound of extra packaging, in addition to the packaging on the Eaches.

For the pallet, there is 50 pounds of extra packaging, in addition to the packaging on the Cases and Eaches.

GTIN	Trade Item Unit Descriptor	Total Quantity Of Next Lower Level Trade Item	Net Measurement				Gross Measurement	
			Net Content	Net Content UoM	Net Weight	Net Weight UoM	Gross Weight	Gross Weight UoM
40012345789005	Pallet	100			1000	LB	1350	LB
10012345789004	Case	10			10	LB	13	LB
00012345789007	Each	n/a	1	LB		LB	1.2	LB

9.4.4 Example in Metric Measure – Net Content Expressed as an Each (Television)

For the each, there is a Net Content of 1 EA (the television set) which weighs 15 kg, and packaging weighing 2.5kg.

For the case, there is 3 kg of extra packaging, in addition to the packaging on the Eaches.

For the pallet, there is 15 kg of extra packaging, in addition to the packaging on the Cases and Eaches.

GTIN	Trade Item Unit Descriptor	Total Quantity Of Next Lower Level Trade Item	Net Measurement				Gross Measurement	
			Net Content	Net Content UoM	Net Weight	Net Weight UoM	Gross Weight	Gross Weight UoM
07612345543239	Pallet	10			300	KG	395	KG
07612345543222	Case	2			30	KG	38	KG
07612345543215	Each	n/a	1	EA	15	KG	17.5	KG

9.4.5 Example in Imperial Measure – Net Content Expressed as an Each (Hair Dryers)

For the each, there is a Net Content of 1 EA (the hair dryer), and packaging weighing 0.5 pounds.

For the case, there is 1 pound of extra packaging, in addition to the packaging on the Eaches.

For the pallet, there is 15 pounds of extra packaging, in addition to the packaging on the Cases and Eaches.

GTIN	Trade Item Unit Descriptor	Total Quantity Of Next Lower Level Trade Item	Net Measurement				Gross Measurement	
			Net Content	Net Content UoM	Net Weight	Net Weight UoM	Gross Weight	Gross Weight UoM
00012345357916	Pallet	100			200	LB	515	LB
00012345234569	Case	4			2	LB	5	LB
00012345123214	Each	n/a	1	EA			1	LB

9.4.6 Example in Imperial Measure – Net Content Expressed as Usages (Detergent)

For the each, there is a Net Content of 96 Usages (washes of detergent) which weighs 10 pounds, and packaging weighing 0.5 pounds.

For the case, there is 1 pound of extra packaging, in addition to the packaging on the Eaches.

For the pallet, there is 15 pounds of extra packaging, in addition to the packaging on the Cases and Eaches.

GTIN	Trade Item Unit Descriptor	Total Quantity Of Next Lower Level Trade Item	Net Measurement				Gross Measurement	
			Net Content	Net Content UoM	Net Weight	Net Weight UoM	Gross Weight	Gross Weight UoM
20012345500019	Pallet	48			1920	LB	2127	LB
10012345500012	Case	4			40	LB	44	LB
00012345500015	Each	n/a	96	Z52	10	LB	10.5	LB

- **Note:** Z52 is the code for "Usage"

10 Trade Item Country of Origin

Trade Item Country of Origin is the country of manufacture, production, or growth where an article or product comes from. When shipping products from one country to another, the products may have to be marked with Country of Origin, and the Country of Origin will generally be required to be indicated in the export/import documents and governmental submissions.

In some instances, Trade Item Country of Origin may not be specified on the product. Subsequently, the country code (codes) in which the goods have been produced or manufactured, according to criteria established for the purposes of application of the value, may not be presented on the trade item label.

Trade Item Country of Origin can also represent the Country of Origin for goods entirely obtained in a single country or the country in which the last substantial "transformation" of the goods occurred. Transformation is defined as grinding, chopping, or mixing different products/ingredients together to create a new item. For example, let's say the trade item is a pizza. The tomato sauce and dough could be from the US, the cheese from Italy, and the completed pizza made in Canada. Therefore, the Country of Origin would be Canada.

- **Note:** The Trade Item Country of Origin code does not represent the Country of Origin of the individual ingredients used to create the end product.
- **Note:** European Union (EU 097) is an acceptable Country of Origin for products identified as processed in the European Union. It may or may not meet business or regulatory requirements for country of origination labelling.

- **Note:** Trade Item Country of Origin is repeatable.

Trade Item Country of Origin – Multiple Countries

For the same Trade Item that is simultaneously produced in multiple countries, Trade Item Country of Origin refers to each of the countries where it could be produced. Country of Origin should be repeated for each country. The recipient should be prepared to receive multiple values for this attribute.

Trade Item Country of Origin - Fresh Produce

For fresh produce, Trade Item Country of Origin refers to where the products have been grown and harvested. Country of Origin may have to be listed for all individual items in a package if they have different countries of origin. For example: an eggplant, tomato and pepper pre-packed on a scale can have 3 countries of origin.

Trade Item Country of Origin - Foodservice Products

For Foodservice products, there may be a need to identify the Country of Origin of each individual ingredient. This need may also apply to retail products that are identified between data supplier and data recipient as products with a need to identify the Country of Origin of some or each individual ingredient.

10.1 Pre-Requisite

In certain geographies, local regulations may require that if there are several countries of origin, all countries of origin must be indicated. Manufacturers and Retailers will collaborate to identify these local variations. Manufacturers can provide multiple instances of Country of Origin and Retailers will determine how many instances they will store.

10.2 When Would I Use This?

Trade Item Country of Origin should be provided at the trade item level that is relevant.

In some industries (such as food service or Hardlines) trade items are usually identified at the case level only, therefore Country of Origin would apply at the case level.

10.3 Examples of Country of Origin

Example 1

Country of Origin = Italy



Example 2:



- **Note:** The coffee beans are from Indonesia, Kenya and Ethiopia; the product was processed in Canada therefore the Country of Origin is Canada.

11 Item Futurisation

Item Futurisation primarily describes the process of informing (in advance) about changes to the master data of a Trade Item. When using Item Futurisation within GDSN, the main considerations are to:

- Control the synchronisation process
- Ensure the data recipient understands correctly the intention of the data source

This section is structured into a number of process scenarios which illustrate the possibilities. It also takes into consideration that one of the parties may not fully support Item Futurisation, but nevertheless is capable of providing advance information about changes to master data.

11.1 Why Would I Use This?

Prior to Item Futurisation, a variety of heterogeneous, non-standardised practices have been established to support Item Lifecycle. Data accuracy requires a standard approach of representing simultaneous availability of item data and future item changes (that do not require a GTIN change) to support full item lifecycle maintenance. This improves supply chain management in processes such as:

- Automation of operational processes, including
 - Purchase orders
 - Receipt of goods
 - Automated acceptance/rejection
- Automation of planning processes, including
 - Shelf planning
 - Store planning
 - Logistics
 - Assortment planning
 - Forecasting

During the Trade Item’s life cycle its characteristics may change due to many different reasons. These changes are characterised as Trade Item **versions**.

- **Important:** GDSN participants who publish changes in advance (i.e. use a future Effective Date) but do not implement full Item Futurisation (with multiple versions according to Effective Date), could run the risk of Data Recipients not receiving the information that the Data Source was intending. If the Source Data Pool has not implemented **IF**, there could be a risk that a subscription will be filled with the version most recently published in the Network and the retailer would not be aware of the correct (current or any intermediate) versions. Some data pools only store the last one received.
- **Important:** All changes that affect Trade Item life cycle must adhere to the [GTIN Management Standard](#).
- **Note:** Corrections (applying only to errors) should be covered by existing processes. Item Futurisation requires no extra correction functionality.
- **Note:** Any time when there is a version change in the Life Cycle of a Trade item there is a period in time where more than one version of the trade item can co-exist within the supply chain. Item Futurisation may help to minimise that period by explicitly declaring the dates of the change in advance of the change being released into the supply chain while still retaining information relating to previous trade item version(s). However using Item Futurisation does not imply absolute control of stock in the supply chain when a Trade Item changes from one version to another. Absolute control can only be guaranteed by using a new GTIN, and manufacturers should always allocate a new GTIN if stock separation is essential.
- **Note:** Item Futurisation is optional functionality within the GDS Network. As such, not all GDSN-certified data pools will be required to implement this functionality. The introduction of Item Futurisation into the GDSN Network will have no impact on existing parties except where they choose to implement Item Futurisation. Should a trading partner member of the GDSN community desire to support or utilise this functionality, they should contact their trading partners and their GDSN data pool to ensure full support.

11.2 Pre-Requirement

11.2.1 Pre-Requirements for Implementers

The Data Source must have the:

- Technical ability to store more than one item version simultaneously behind the firewall
- Technical ability and business process in place to handle effective date (especially future effective dates)

The Data Recipient must have:

- Technical ability of receiving and storing of multiple item versions
- Must be able to use the **effectiveDate** in a way to derive the different item versions and the time sequence

11.2.2 Pre-Requirements for Non-Implementers

Item Futurisation is optional functionality in GDSN. This means that information exchanges must still be capable of correct interpretation and processing even if one of the parties has not implemented Item Futurisation.

For the Data Source:

- It is assumed Version handling is not implemented internally
- The Data Source may opt to use value add services from source data pool
- Even if not an implementer, the Data Source can use standard GDSN attribute **effectiveDate** to control information in a way which can be correctly interpreted by a Data Recipient who has implemented Item Futurisation (see Section [11.8](#)).

For the Data Recipient:

- It is assumed he cannot handle multiple item versions
- The Data Recipient (or Recipient Data Pool) must be able to use the **effectiveDate** in a way to derive the different item versions and the time sequence
- Even if not an implementer, the Data Recipient can use standard GDSN attribute **effectiveDate** to understand information sent by a Data Source who has implemented Item Futurisation (see Section [11.7](#)).

11.3 When Would I Use This?

To answer this question it is helpful to have a brief look at the “GTIN Management Standard” as found on the [GTIN Management Standard](#) website.

A Global Trade Item Number (GTIN) is used to identify any item upon which there is a need to retrieve pre-defined information and that may be **priced** or **ordered** or **invoiced** at any point in any supply chain.

Although this list is not exhaustive, the basic pre-defined characteristics of a trade item include:

- The Product Name, Product Brand, and Product Description
- The trade item type and variety
- The net quantity of trade item (weight, volume, or other dimension impacting trade)

A modification to any of the basic elements that characterise a trade item will usually lead to a change in the GTIN.

Typically the gross dimensions modifications that do not affect net trade item quantity or measure do not impact the GTIN assignment. However, if any gross dimension (e.g. length, depth, weight, etc.) changes by more than 20% a new GTIN is required.

Item Futurisation is used to communicate those **minor changes** that do not require a new GTIN to trading partners.

11.4 Explanation of Relevant Attributes

11.4.1 Effective Date

All processes are driven by the date specified in Effective Date.

- **Note:** Versions are identified by Date, not by Time within Day. There will not be more than one GTIN Version on the same day.

When Item Futurisation is used the Effective Date is an anticipated date in the future when the changes are expected to occur.

11.5 Attribute Restrictions – Can Any Attributes not be “Futurised”?

#	Answer	Examples
1	It is not possible to create a Version of a GTIN if the change in attribute values requires a new GTIN to be allocated (according to the GTIN Management Standard). Thus the only restrictions on attributes are those attributes which when changed require a new GTIN to be allocated.	<p>Example 1: Net Content: any change to Net Content will always force a new GTIN to be allocated.</p> <p>Note: it is of course possible to send a new GTIN with the changed Net Content in advance i.e. with a future Effective Date.</p> <p>Example 2: if Width changes by more than 20%, then a new GTIN must be allocated. However if the change in Width is less than 20%, then the party allocating the GTIN may choose to keep the old GTIN and instead communicate a new GTIN Version to the Data Recipient.</p>
2	It is not possible to change the Effective Date for an existing version. For advice on how to work around when the Effective Date should be changed, see section 11.7 .	Not Applicable
3	The hierarchy must stay consistent across versions.	Not Applicable
4	Futurised Trade Item data must continue to be validated against all GDSN Validation Rules.	Not Applicable

11.6 Explanation of the function of Dates in Item Futurisation

11.6.1 Initial Creation

No End Date to the First Version

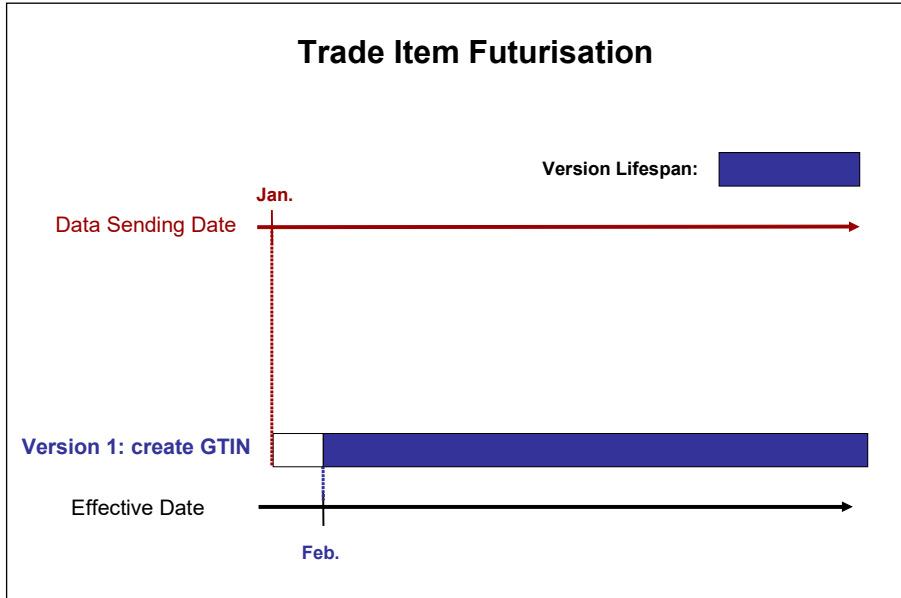

11.6.2 Second Version

Announce in March a change planned to take effect in May. This means the first version will cease to be the Current Version in May.

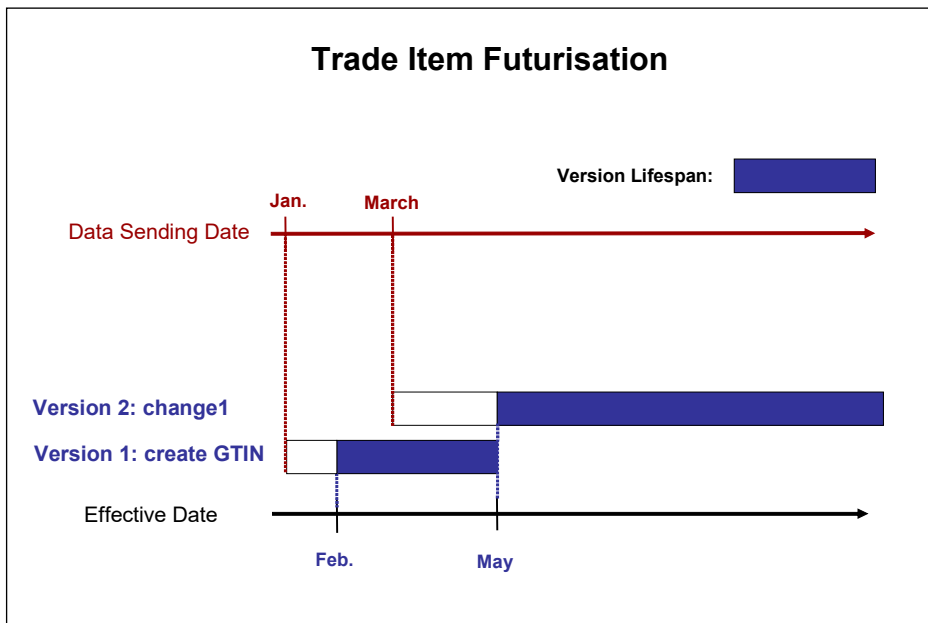

11.6.3 Third Version

Announce in April a change planned to take effect in June. This means the second version will cease to be the Current Version in June.

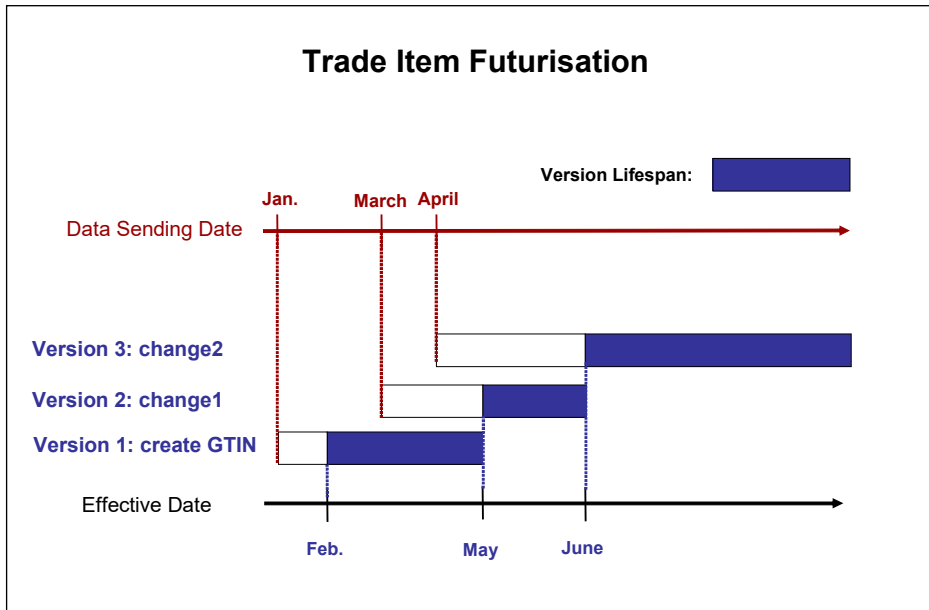

11.6.4 Discontinue the GTIN

This is announced in April and planned to take effect in October. This means the third version will cease in October when the GTIN is discontinued.

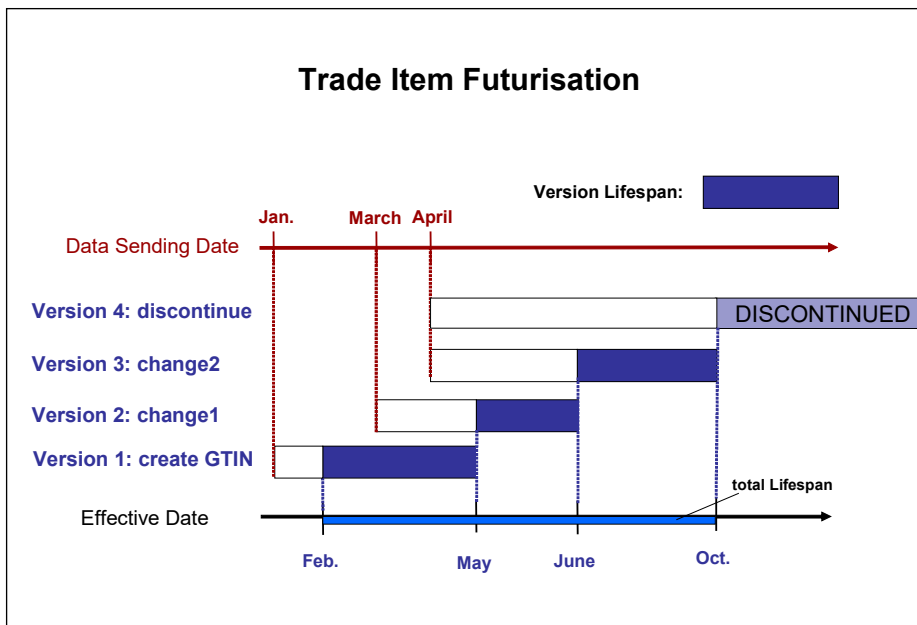

- **Note:** The “end date” of a version is the Effective Date of the next Version. This is why an End Date is not sent for each version.
- **Note:** A Future Version automatically becomes the Current Version when the calendar date reaches the Effective Date of the Item Version. This means there is no overlap between versions, and only one version is the Current version at any point in time.

Table 11-1 Description of Terms

Term	Description
Historic Version	Has a version start date that is previous to the version start date of the current Trade Item version.
Current Trade Item Version	Has the most recent version start date not in the future.
Future Trade Item Version	Has a version start date after the current date.
Intermediate Trade Item Version	Falls between current and one or more Future Trade Item Versions

11.7 Scenarios for Item Futurisation Implementers: Both Implemented

These scenarios assume that the data source and recipient have both implemented Item Futurisation.

- **Note:** dates in the examples are assumed to be all in one calendar year. For ease and to stay current, they are shown without a year e.g. as 1-Apr, not as 1-Apr-2008.

11.7.1 Create and Publish a New GTIN

Item Futurisation does not change the process for creating and publishing a new GTIN. The process continues as normal, as for any GDSN exchange.

Effective Date is as normally defined in the GDSN standards.

11.7.2 Create a New Future Version of a GTIN

Data Source

To create a new Future Version, the Data Source sends:

- A CHANGE message containing the revised attribute values;
- The same GTIN as before;
- A future Effective Date;

Note: the Data Pools can simply pass the message through to the Data Recipient, even if the Data Pools have not fully implemented Item Futurisation themselves.

Data Recipient – Message Processing

On receipt of the Item CHANGE message, the Data Recipient should:

- Find the GTIN in their internal database;
- Compare the data (message to database);
- Check whether the Effective Date is the current date already held in the internal database, or is a new Date not previously advised;
- On detecting a new future Effective Date, this creates a new Item Version record in the internal database.
- It is an internal matter for the DR to decide how to process the changes in the new Version (for example, a retailer detecting an increase in Height might choose to trigger re-planning Space Management for the GTIN).
- On detecting the same Effective Date, if the changes are acceptable, then overwrite the existing Item Version record in the internal database.

- **Note:** the processes internal to the retailer may be different depending on their internal established database functions and processes.

11.7.3 Create an Intermediate Version of a GTIN

- **Definition:** An Intermediate Version is a version which will be placed between two existing Future Trade Item Versions, or between the Current and one or more Future Trade Item Versions

For instance, if on 1-Jan there are already existing Versions dated 1-Feb and 1-April, then to create a Version dated 1-March is to create an Intermediate Version.

Data Source

To create an intermediate Future Version, the Data Source sends:

- A CHANGE message containing the revised attribute values;
- The same GTIN as before;
- A future Effective Date which has not been sent before and which lies between two existing Future Versions;

Note: the Data Pools can simply pass the message through to the Data Recipient, even if the Data Pools have not fully implemented Item Futurisation themselves.

Data Recipient – Message Processing

On receipt of the Item CHANGE message, the Data Recipient should:

- Find the GTIN in their internal database;
 - Compare the data (message to database);
 - On checking whether the Effective Date is the current date already held in the internal database, the Data Recipient finds it is a new date which lies between existing Future Versions in the internal database;
 - The Data Recipient creates a new Intermediate Item Version record in the internal database.
 - The new Intermediate Version will be sequenced by data between the existing Future Versions.
 - It is an internal matter for the DR to decide how to process the changes in the new Version (for example, a retailer detecting an increase in Height might choose to trigger re-planning Space Management for the GTIN).
- **Note:** the processes internal to the retailer may be different depending on their internal established database functions and processes.

11.7.4 Change an Existing Future Version of a GTIN

Data Source

To change an existing Future Version, the Data Source sends:

- A CHANGE message containing the revised attribute values;
- The same GTIN as before;
- A future Effective Date which has been sent before; this Effective Date is the identifier of the Version which the Data Source wishes to change;

Note: the Data Pools can simply pass the message through to the Data Recipient, even if the Data Pools have not fully implemented Item Futurisation themselves.

Data Recipient – Message Processing

On receipt of the Item CHANGE message, the Data Recipient should:

- Find the GTIN in their internal database

- Compare the data (message to database)
 - On checking whether the Effective Date is the current date already held in the internal database, the Data Recipient finds it is an existing date in the internal database
 - The Data Recipient reviews the changes from the message against the data in the existing Item Version record in the internal database. If acceptable, he applies the change to the existing Item Version record in his Internal Database.
- **Note:** the processes internal to the retailer may be different depending on their internal established database functions and processes.

11.7.5 Correct an Existing Future or Current Version of a GTIN

Data Source

To correct the Current Version or an existing Future Version, the Data Source sends:

- A CORRECT message containing the revised attribute values;
 - The same GTIN as before;
 - An Effective Date which has been sent before; this Effective Date is the identifier of the Version which the Data Source wishes to correct;
- **Note:** the Data Pools can simply pass the message through to the Data Recipient, even if the Data Pools have not fully implemented Item Futurisation themselves.
 - **Note:** by using the CORRECT action in GDSN, the Data Source is able to make corrections, even if those corrections are outside the GTIN Management Standard. Care should be taken as this kind of change can be disruptive to the supply chain unless properly managed. It should never be used as a way of avoiding the GTIN Management Standard.
 - **Important:** the Data Source has the responsibility to send changes & corrections for **each** Future Version (or the Current Version) to which the change applies. For instance, if Future Versions exist dated **1-Feb** and **1-Apr**, if the Data Source send a Correction to the Version 1-Feb, he should also consider whether he needs to send another correction to update the Version **1-Apr**.

Data Recipient – Message Processing

On receipt of the Item CHANGE message, the Data Recipient should:

- Find the GTIN in their internal database
 - Compare the data (message to database)
 - On checking whether the Effective Date is the current date already held in the internal database, the Data Recipient finds it is an existing date in the internal database
 - The Data Recipient reviews the changes from the message against the data in the existing Item Version record in the internal database. If acceptable, he applies the change to the existing Item Version record in his Internal Database.
- **Note:** the processes internal to the retailer may be different depending on their internal established database functions and processes.

11.7.6 Change the Effective Date of an Item Version

The process for a delayed Effective Date is

- Change the data of the old version back to the former data values
- Set up a new version with the revised data values

The process for an Effective Date which is brought earlier is

- Set up a new (earlier) version with the revised data values

This is because for implementers of Item Futurisation, the Effective Date is part of the key of the Item Version, so to "change" the Effective Date is to delete a record and create a new record.

11.7.7 Discontinue/Cancel a GTIN

Item Futurisation does not change the process of discontinuing or cancelling a GTIN. When the GTIN is discontinued, if there is more than one version of the GTIN, then all versions of the GTIN will be discontinued (or cancelled).

In effect the Discontinue Date (or Cancellation Date) of the GTIN becomes the "end date" of any versions which are still current or future at that time.

- **Note:** it is not possible to discontinue or cancel an individual GTIN **Version**.

11.8 Scenarios for Item Futurisation Data Recipient: Non-Implementers

This section assumes that the data recipient is not implementing Item Futurisation but the data source has implemented Item Futurisation.

- **Important:** As Item Futurisation is optional functionality in GDS, there should be no impact on a non-implementing Data Recipient if the Data Source chooses to implement Item Futurisation. However, the Data Recipient may have to filter out future versions that may be sent by the Recipient Data Pool or the Recipient Data Pool may filter the future versions for the data recipient as part of a "value add" service for the Data Recipient.

11.9 Scenarios for Item Futurisation Data Source: Non-Implementers

These scenarios assume that the Data Recipient has implemented Item Futurisation but the Data Source is not implementing Item Futurisation.

11.9.1 Create and Publish a New GTIN from a Non-Implementer Source

Item Futurisation does not change the process for creating and publishing a new GTIN. The process continues as normal, as for any GDSN exchange.

Effective Date is as normally defined in the GDSN standards.

11.9.2 Create a New Future Version of a GTIN from a Non-Implementer Source

Data Source

To create a new Future Version, the Data Source sends:

- A CHANGE message containing the revised attribute values, as normal;
- The same GTIN as before, as normal;
- A future Effective Date;

- **Note:** The Data Pools can simply pass the message through to the Data Recipient, even if the Data Pools have not fully implemented Item Futurisation themselves.

- **Note:** GDSN standards have always permitted a future Effective Date. However, in some geographies it has been the practice of some Data Recipients not to accept a future Effective Date.

Data Recipient – Message Processing

For the Data Recipient, there is no difference; the processing is exactly as if the Data Source had implemented Item Futurisation. See section [11.7.2](#) for details.

On receipt of the Item CHANGE message, the Data Recipient should:

- Find the GTIN in their internal database;
 - Compare the data (message to database);
 - Check whether the Effective Date is the current date already held in the internal database, or is a new Date not previously advised;
 - On detecting a new future Effective Date, this creates a new Item Version record in the internal database.
 - It is an internal matter for the DR to decide how to process the changes in the new Version (for example, a retailer detecting an increase in Height might choose to trigger re-planning Space Management for the GTIN).
 - On detecting the same Effective Date, if the changes are acceptable, then overwrite the existing Item Version record in the internal database.
- **Note:** the processes internal to the retailer may be different depending on their internal established database functions and processes.

11.9.3 Create an Intermediate Version of a GTIN from a Non-Implementer Source

Same as before, see section [11.7.2](#). If the DS has not implemented IF, there is no difference between creating a new Version and creating an Intermediate Version. He simply sends the change with the appropriate Effective Date.

For the IF-enabled Data Recipient, there is no difference; the processing is exactly as if the Data Source had implemented Item Futurisation. See section [11.7.3](#) for details.

11.9.4 Change an Existing Future Version of a GTIN from a Non-Implementer Source

If the DS has not implemented IF, there is no difference between creating a new Version and changing an existing Future Version. He simply sends the change with the appropriate Effective Date.

For the IF-enabled Data Recipient, there is no difference; the processing is exactly as if the Data Source had implemented Item Futurisation (see section [11.6.3](#) for details).

- **Important:** If the Data Source has not implemented IF then he will not explicitly specify which version(s) are changing. He might not have the control to refer to exactly the same Effective Date. The Data Recipient must decide how to apply the change. For instance, he could set up a new version according to the Effective Date. Or he could apply a correction to the existing Version.

11.9.5 Correct an Existing Future Version of a GTIN from a Non-Implementer Source

If the DS has not implemented IF, there is no difference between creating a new Version and correcting an existing Version. He simply sends the correction with the appropriate Effective Date.

For the IF-enabled Data Recipient, there is no difference; the processing is exactly as if the Data Source had implemented Item Futurisation (see section [11.6.3](#) for details).

- **Important:** The Data Source has not implemented IF so he does not have the capability to send changes & corrections for **each** Future Version (or the Current Version) to which the change applies. As always the DR should take care in interpreting corrections.

11.9.6 Discontinue a GTIN to a Non-Implementer Recipient

Item Futurisation does not change the process of discontinuing or cancelling a GTIN. When the GTIN is discontinued, if there is more than one version of the GTIN, then all versions of the GTIN will be discontinued (or cancelled).

In effect the Discontinue Date (or Cancellation Date) of the GTIN becomes the “end date” of any versions which are still current or future at that time.

- **Note:** it is not possible to discontinue or cancel or withdraw an individual GTIN Version.

11.10 Other Useful Information

1. It is not possible to **Delete** a Version. Only a GTIN can be marked for deletion or discontinuation.
2. The CIC message if generated by the retailer is applicable to all versions of the Trade Item, and not to a specific Trade Item Version. More detailed information will be developed beyond the creation of the BRAD Document to document at a later time.

An example may include TI-HI info missing. In this case all versions are treated as a single Trade Item and it would be up to the supplier to determine which version is affected.

11.11 Advice for Data Pools

This section provides information specific to Data Pools.

11.11.1 Technical Characteristics for Implementing Data Pools

Source Data Pool

- Technical ability to store more than one item version simultaneously.
- Technical ability to handle the effective date (especially future effective dates)
- Technical ability to send out data sorted by **effectiveDate** (oldest version first) – Best Practice
 - This facilitates a non-implementing recipient data pool to receive the latest version last

Recipient Data Pool

- Technical ability to handle more than one item version simultaneously.
- Technical ability to store multiple versions by using the effective date within the item as primary key
- Ability to filter preferred versions on behalf of data recipient (as a value added service). Especially if the data recipient is not implementing Item Futurisation.

11.11.2 Technical Characteristics for Non-Implementing Data Pools

Source Data Pool

- May not store more than one item version simultaneously (at data pool’s discretion)
- Future effective dates can be processed as a standard GDSN function

Recipient Data Pool

- May not store more than one item version simultaneously (at data pool's discretion)
- Only pass through the received CINs in a correct time sequence (first in first out)
- Optional: ability to filter the preferred item versions on behalf of the data recipient (add on service)

11.11.3 Risks to be noted

GDSN participants who publish changes in advance (i.e. use a future Effective Date) but do not implement full Item Futurisation (with multiple versions according to Effective Date) run the risk at times that Data Recipients may not receive the information the Data Source was intending:

- **Note:** If the SDP has not implemented IF, then a risk is that a subscription will be filled with the version most recently published in the Network and the retailer would not be aware of the correct (current or any intermediate) versions. Some data pools only store the last one received
- **Important:** General GDSN Risk: If the SDP has not implemented IF, then a risk is that when a new retailer subscribes to a GTIN for the first time AFTER an Intermediate Version has been sent by the DS, then the new retailer will receive the Intermediate Version but not the latest Future Version, and he will not be notified of that later Future Version even when it becomes the Current Version.

12 Broker Distributor Model

In a simple supplier model, the supplier is responsible for the flow of information and goods through the supply chain. In the Broker/Distributor model, the supplier has made a strategic decision to differentiate the flow of information and goods between several companies to the Retailer. As a result, we will explore how Data Synchronisation can be leveraged to enhance the Broker/Distributor model in a complex supply chain.

12.1 Pre-Requisite

- The Information provider and data recipient must be a member of GS1
- All parties must have a GLN assigned to their organisation to participate in the Global Data Synchronisation Network (GDSN)
- All parties (information providers and data recipients) agree to exchange data in GDSN through the use of a certified Data Pool

12.2 When Would I Use This?

This model is to serve as an example of how data synchronisation has been established in actual business relationships between Manufacturers, their Brokers, Distributors, Retailers, and Wholesalers. The information in this section should not be interpreted as a standard or requirement, but should be used to determine how your company may leverage data synchronisation to fit your relationship with your Trading Partners whether you are a Manufacturer, Broker, Distributor or Wholesaler.

12.3 How to Use These Guidelines

There is not one right way to describe how item synchronisation fits into the Broker/Distributor model. As a result, the best way to exemplify this model is to describe the 3 basic scenarios companies are following when implementing item synchronisation. Each scenario will be briefly described with information pertaining to the Brand Owner and/or Manufacturer, the Distributor, the Broker, and the

Wholesaler if applicable. Several business examples will be provided for each scenario followed by the overall item synchronisation model. The 3 basic scenarios included in this section are:

- Brand Owner takes sole responsibility for synchronisation (section [12.4](#))
 - Brand Owner delegates synchronisation responsibility (section [12.5](#))
 - A shared synchronisation responsibility between Brand Owner, Distributors, and Wholesalers (section [12.6](#))
-
- **Note:** A Broker serves as a sales agent for the Brand Owner, Manufacturer, and/or Wholesaler. As a result, the data synchronisation model for brokers fits into all three of the scenarios mentioned above.
 - **Note:** For a detailed technical definition of the acronyms and an understanding of the process flow depicted within this diagram, see Catalogue Item Sync Business Message Standard (BMS) which is located in [GDSN standards website](#).

12.4 Brand Owner Retains Sole Synchronisation Responsibility

This scenario is typically selected by Brand Owners using a network of distributors that may or may not manufacture but delivers products to the retailer. Key characteristics of the scenario are:

- There is no implication for the Data Synchronisation process based on the legal relationship between the Brand owner, a manufacturer and the distributor
- The Brand Owner determines the product specifications
- The Brand Owner serves as the single data source for product information (global, local and relationship dependent) and synchronises the information with the Retailer (Data Recipient)

The scenario is described in the following business examples.

12.4.1 Contracted Distributor

The most basic examples of the Brand Owner retaining sole synchronisation responsibility is that of a contracted Distributor. In this Business example (Pre-Requisite), the Brand Owner contracts the Distributor(s) to deliver the product to the Retailer on their behalf. The Brand Owner invoices the Retailer and the Distributor(s) is responsible for delivering the product to the Retailer. In this example, only the Brand Owner will be required to synchronise the item data with the Retailer. The Distributor does not need to be involved in the Item Synchronisation. See [12.4](#) to reference the data synchronisation model for this example.

- **Note:** This example remains the same if the Brand Owner either manufactures or contracts manufacturing of the product.

Figure 12-1 Brand Owner Contacts the Distributor(s)

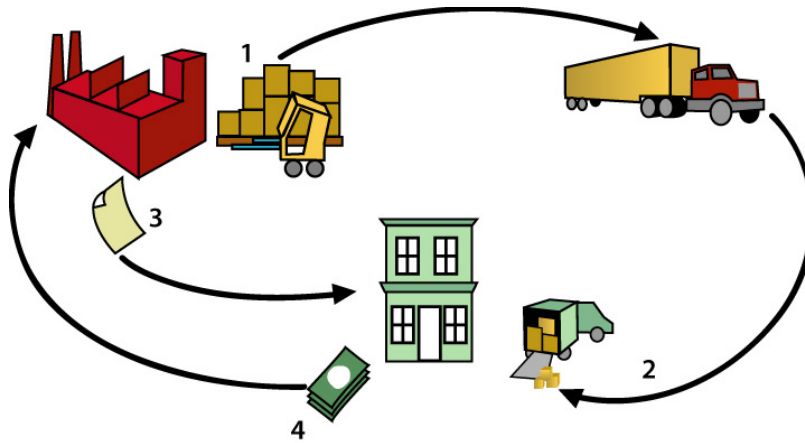

1. The Brand Owner manufactures the product and hires the distributor(s) who will...
2. deliver the product
3. The invoice is sent by the Brand Owner directly to the Retailer and...
4. payment is sent by the Retailer directly to the Brand Owner. The Distributer(s) does not have any relationship with the Retailer.

12.4.2 Multi-National/Multi-Distributor Network

In this Multi-National/Multi-Distributor example (Figure 12-2), the Brand Owner does not manufacture nor distribute the product. The product specifications are communicated through GDSN and non-GDSN channels (1) from the Brand Owner to the Manufacturer/Distributor(s). Once produced, the products are delivered (2) to the Retailer by the Manufacturer/Distributor(s). The invoice is sent by the Manufacturer/Distributor(s) to the Retailer (3) and payment is sent by the Retailer (4) directly to the Manufacturer/Distributor(s). The Brand Owner is the sole source of the item synchronisation message. The Brand Owner item synchronisation scenario may be referenced in Figure 12-4.

Figure 12-2 Brand Owner communicates product specifications through GDSN and non-GDSN channel. The Suppliers then manufacture and distribute the products to the Retailer.

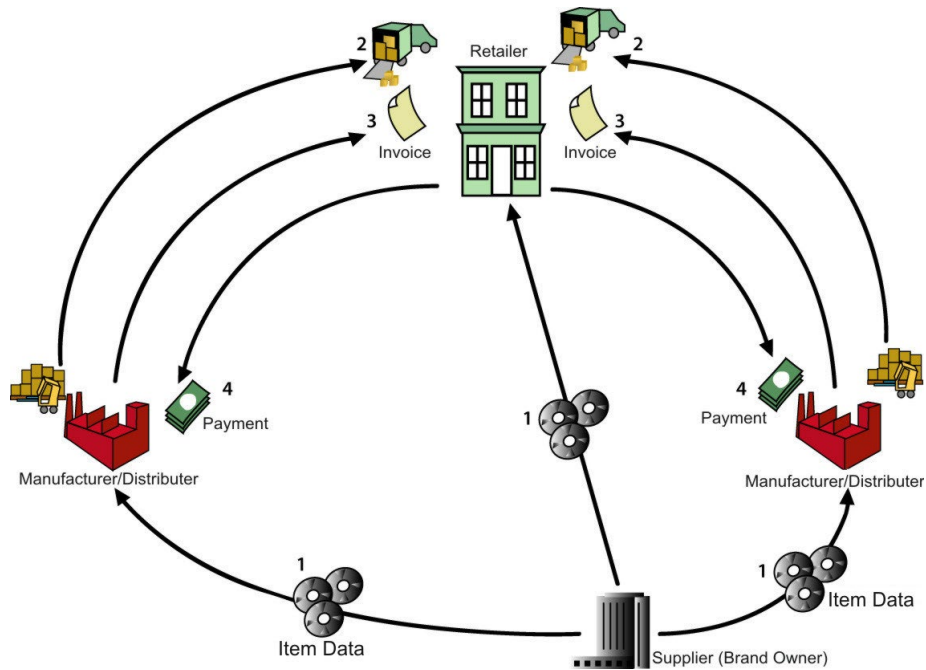

12.4.3 Broker Business Example

There are many roles a Broker plays in business relationships with Manufacturers, Wholesalers and Retailers. In order to focus on Item Synchronisation, this document concentrates on the two most common Broker relationships: **Supplier contracted product sales** and **Retailer contracted business intelligence**.

The Broker has a formal business relationship with the Supplier, not the Retailer even though there will be interaction between the Retailer and Broker. The Supplier begins by (1) presenting a new item to both the Broker and Retailer. Once accepted by the Retailer, The Broker (2) will sell the product into the Retailer. The Broker will communicate any changes to the Retailer that may occur during the life cycle of the product; however, (3) all product and payment exchanges will still flow directly between the supplier and Retailer.

In this example, the Brand Owner has chosen to synchronise its item data directly with the Retailer. An example of this item synchronisation scenario may be reference in [Figure 12-4](#). In some instances, the Brand Owner may also choose to synchronise its data with the Broker. This item synchronisation scenario may be referenced in [Figure 12-5](#).

Figure 12-3 Supplier Contacts Broker

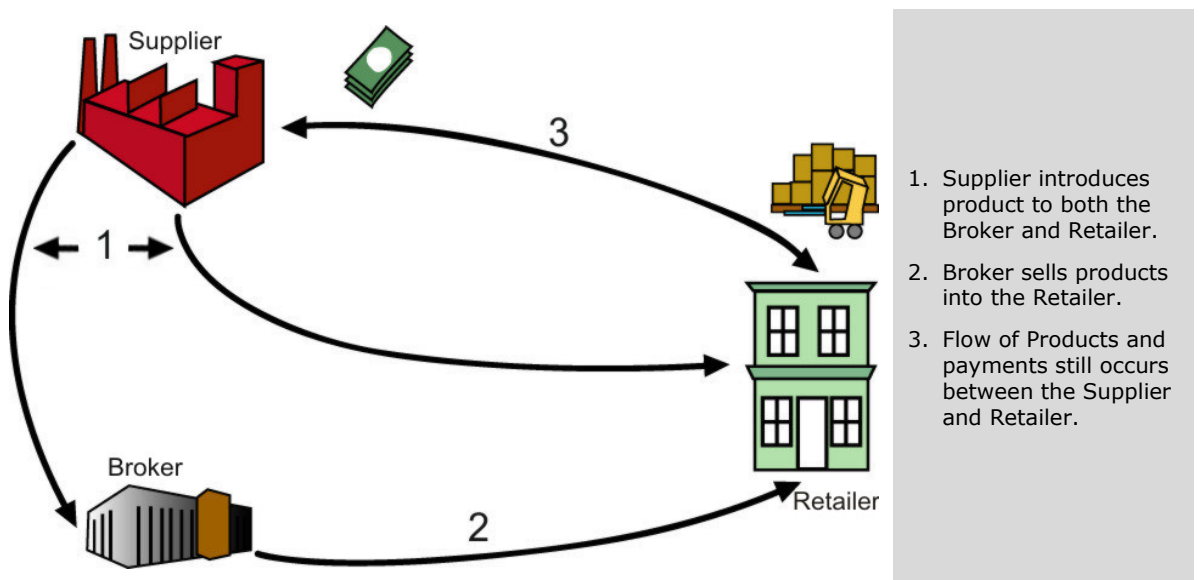

12.4.4 Item Synchronisation Scenario

The business examples described all share the same Item synchronisation scenario where the Brand Owner synchronises with the Retailer.

Figure 12-4 Brand Owner Synchronises Item

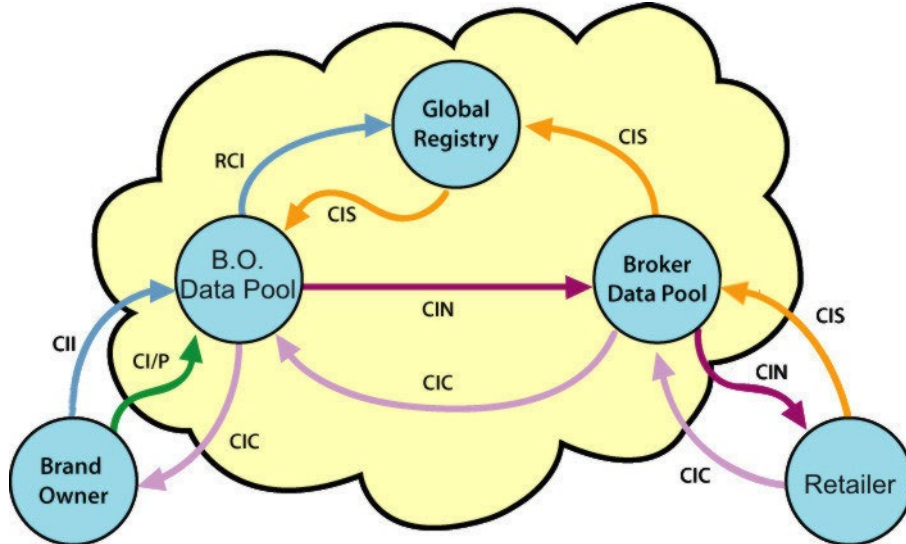

One unique variation can be found with the Broker model. The Brand Owner may also choose to synchronise with the Broker to ensure a fully synchronised supply chain.

Figure 12-5 Item Synchronisation sent to the Broker

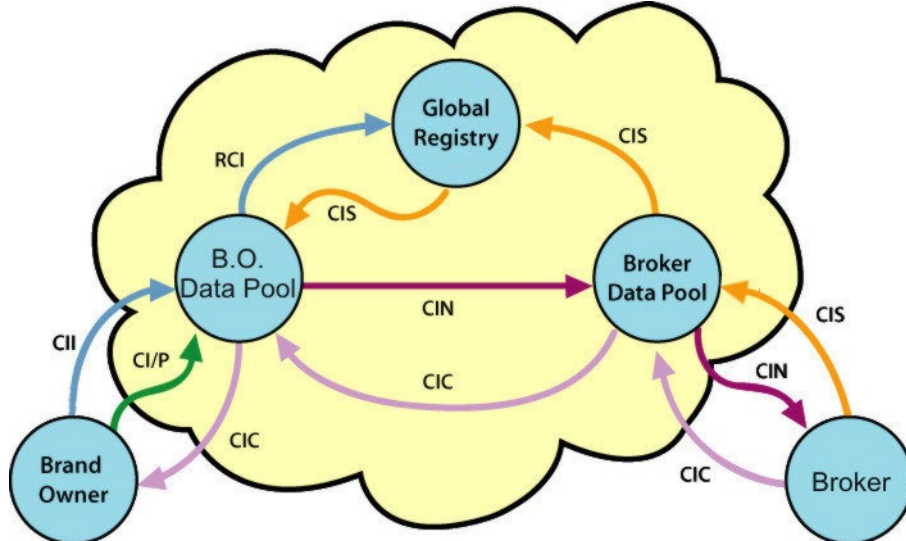

12.5 Brand Owner Delegates Synchronisation Responsibility

In some situations, the Brand Owner chooses not to participate in the synchronisation of item data that is supplied to its Retailers by a network of distributors. Key characteristics of the scenario are:

- The Brand Owner does not synchronise directly with the Retailer, although some brand owners may be synchronising with their distributors
- The Brand Owner determines the product specifications, but may not manufacture the product
- The Brand Owner typically does not distribute the product to the Retailer
- Multiple distributors can serve as a data source for the same product information and synchronise the information with the Retailer (Data Recipient).
- The data that is synchronised is neutral and may include relationship dependent data.

This scenario can be exemplified through the following business examples:

12.5.1 Wholesale Business Example

In a standard wholesale model, the Wholesaler purchases products from the manufacturer and then sells the product to the Retailer. In this specific example, the Retailer will expect item synchronisation with the Wholesaler and not the Manufacturer. The Brand Owner may also synchronise with the Wholesaler. For the Item Synchronisation model please reference [Figure 12-9](#).

Figure 12-6 Wholesale Business Example

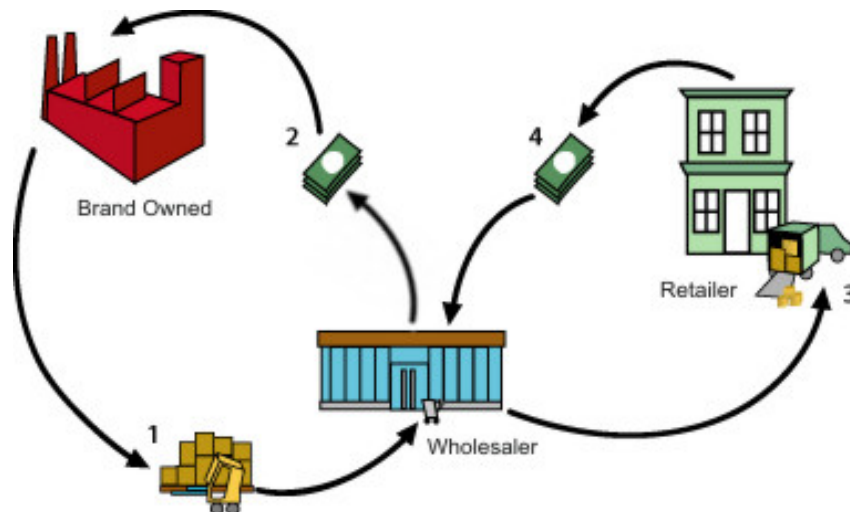

1. The Brand Owner produces the product and sells to the Wholesaler.
2. The Wholesaler then pays the Brand Owner for the products.
3. The Wholesaler sells and distributes the product to the Retailer.
4. The Retailer pays the Wholesaler for the products.

12.5.2 Multi-National/Multi-Distributor Network

A multi-national Brand Owner may decide to delegate item synchronisation to its network of distributors to ensure the proper communication of attributes unique to each distributor. This delegation will require the Brand Owner to communicate common attributes to each of the distributors in its network through GDSN or non-GDSN channels to guarantee the consistency of the GTIN coming from each distributor. In this example, the Brand Owner does not manufacture nor distribute the product. The product specifications are communicated through GDSN or non-GDSN channels from the Brand Owner to the Manufacturer/Distributor.

Figure 12-7 Brand Owner communicates product specifications through GDSN or non-GDSN channel. The Suppliers then manufacture and distribute the products to the Retailer.

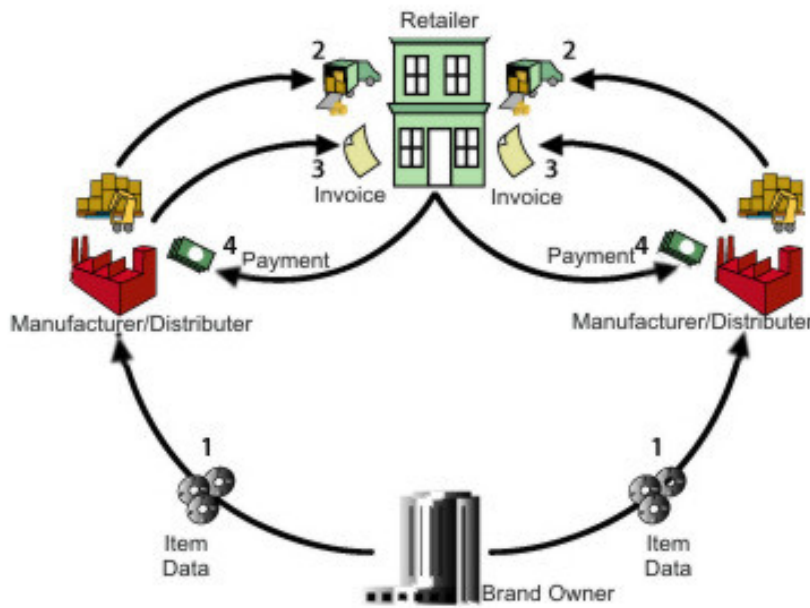

1. The Brand Owner communicates common attributes to the Manufacturer / Distributors.
2. The Manufacturer / Distributors produce and deliver products to the Retailer.
3. An invoice is sent by the Manufacturer / Distributors to the Retailer.
4. The Retailer sends payment directly to the Manufacturer / Distributors.

12.5.3 Private Label / Control Brand

In this business model, a Retailer may choose to select multiple manufacturers to produce the same product with the exact same specifications. In this situation the Brand Owner is the Retailer. Each manufacturer of the product will be required to synchronise the product through the GDSN. For the Item Synchronisation model please reference [Figure 12-9](#).

- **Important:** Retailers must be able to accept synchronised data from multiple manufacturers referencing the same GTIN.

Figure 12-8 Multi-Source Business Example

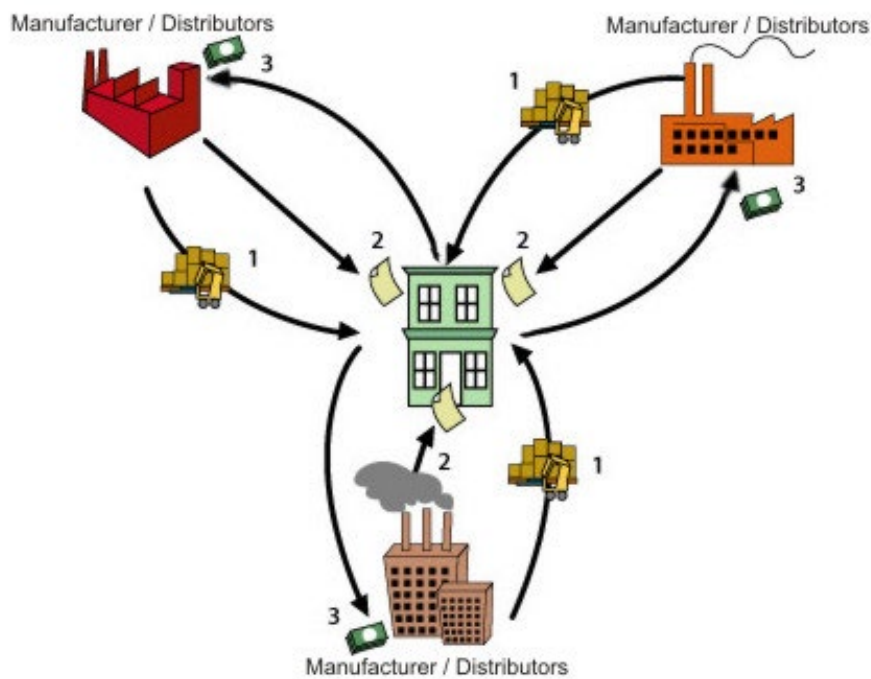

1. The Manufacturer / Distributors produce and deliver products.
2. An invoice is sent by each Manufacturer / Distributor to the Retailer.
3. Payment is sent directly to each Manufacturer / Distributor from the Retailer.

12.5.4 Item Synchronisation Scenario

The three business examples listed above reference the same item synchronisation model where multiple Manufacturers/Distributors can synchronise the same GTIN to the same Retailer.

Figure 12-9

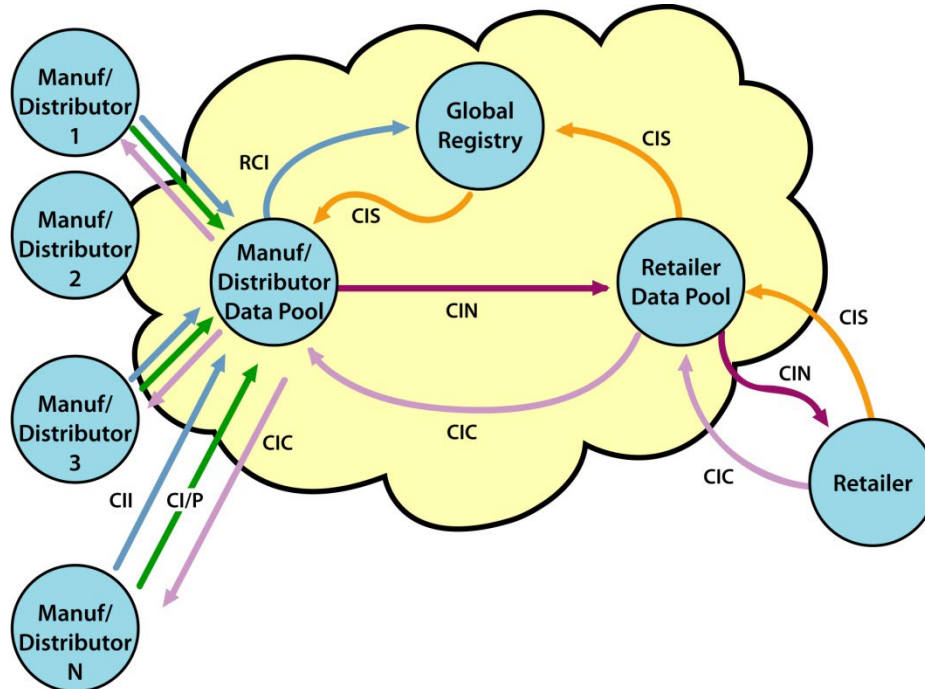

- **Note:** This diagram is not intended to imply that each of the suppliers must belong to the same data pool.

12.6 Shared Synchronisation Responsibilities

It is not uncommon for a Brand Owner that sells products to a Retailer through a network of distributors to also sell the same products themselves directly to Retailers. In this situation, the Brand Owner may decide to share synchronisation responsibilities with the distributors. Key characteristics of this scenario are:

- The Brand Owner uses a network of distributors that manufactures and delivers products to the retailer
- The brand owner is a different legal entity than the Manufacturer/Distributor entity
- Both the Brand Owner and Distributor play a role in the Global Data Synchronisation process
- The Brand Owner is not required to establish data sync prior to the distributor synchronising
- Multiple distributors can serve as a data source for the same product information and synchronise the information with the Retailer (Data Recipient)
- The data that is synchronised is neutral and may include relationship dependent data

This scenario can be exemplified through the following business examples:

12.6.1 Sell to Distributor

A Brand Owner may choose to sell its products to the Distributor. In this situation, the Brand Owner's responsibility is to synchronise the product with the Distributor who will then be responsible for synchronising with the Retailer. In this situation, the Brand Owner does not have a direct relationship with the Retailer. As a result, it is the responsibility of the Distributor to synchronise with the Retailer. For the Item Synchronisation model please reference [Figure 12-12](#).

Figure 12-10 Brand Owner Sells to Distributor

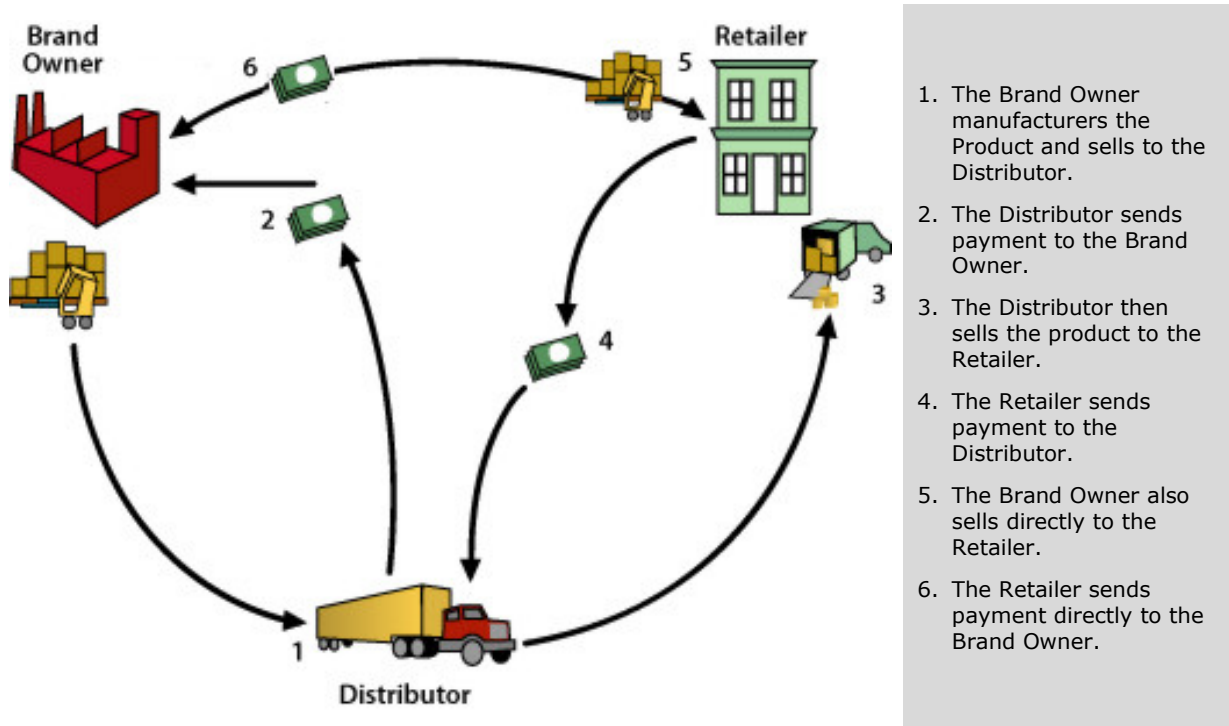

12.6.2 Wholesale Business Example

In this scenario the Brand Owner/Manufacturer is selling to a Wholesaler and a Retailer. Although it is common for the Brand Owner to delegate synchronisation responsibility to the Wholesaler, it is also possible for the Brand Owner to share synchronisation responsibility with its distributors. This is the situation found in a complex supply chain where the Brand Owner supplies the same product to the Retailer as well as the Wholesaler. For the Item Synchronisation model please reference [Figure 12-12](#).

Figure 12-11 Wholesale Business Example

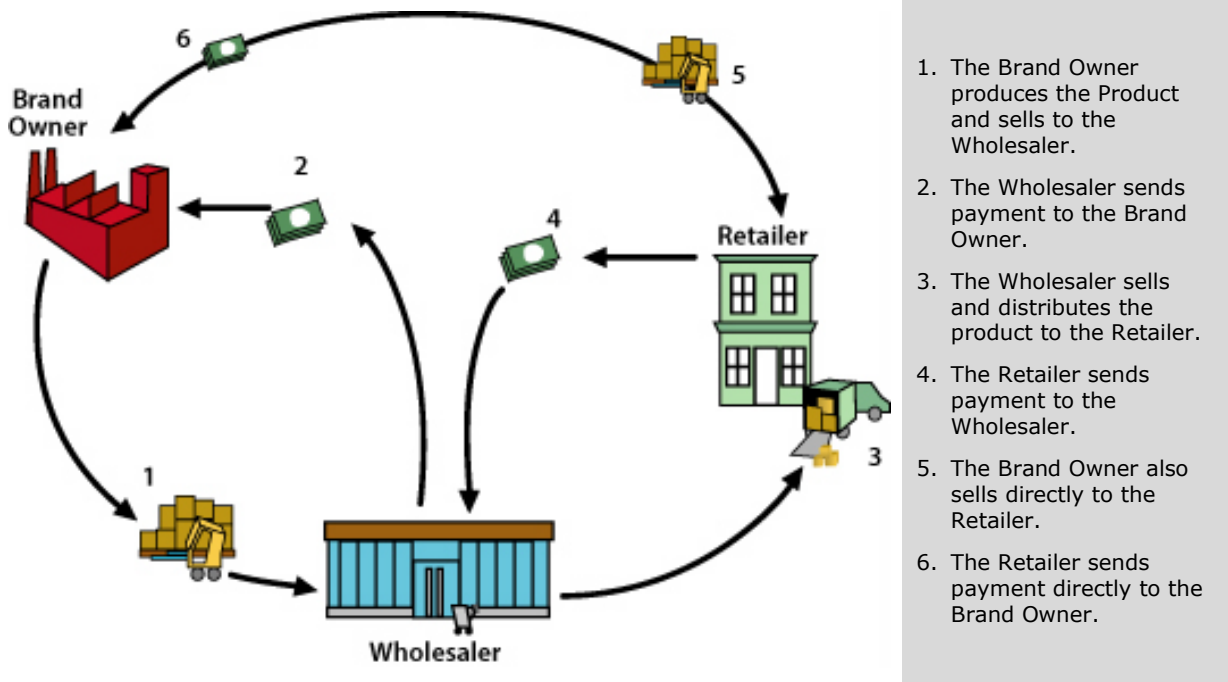

1. The Brand Owner produces the Product and sells to the Wholesaler.
2. The Wholesaler sends payment to the Brand Owner.
3. The Wholesaler sells and distributes the product to the Retailer.
4. The Retailer sends payment to the Wholesaler.
5. The Brand Owner also sells directly to the Retailer.
6. The Retailer sends payment directly to the Brand Owner.

12.6.3 Multi-National / Multi-Distributor Networks

In the situation where a Multi-National / Multi-Distributor Network uses a shared synchronisation model, the business example is the same if the Brand Owner delegates the item synchronisation to its distributor network. The Business Model remains the same ([Figure 12-7](#))

The Suppliers then manufacture and distribute the products to the Retailer.), however the Brand Owner will now synchronise their Items in addition to the Distributors. In this example, the Brand Owner does not manufacture nor distribute the product. The product specifications are communicated through GDSN or non-GDSN channels from the Brand Owner to the Manufacturer/Distributor.

Figure 12-12 Manufacturer/Distributor

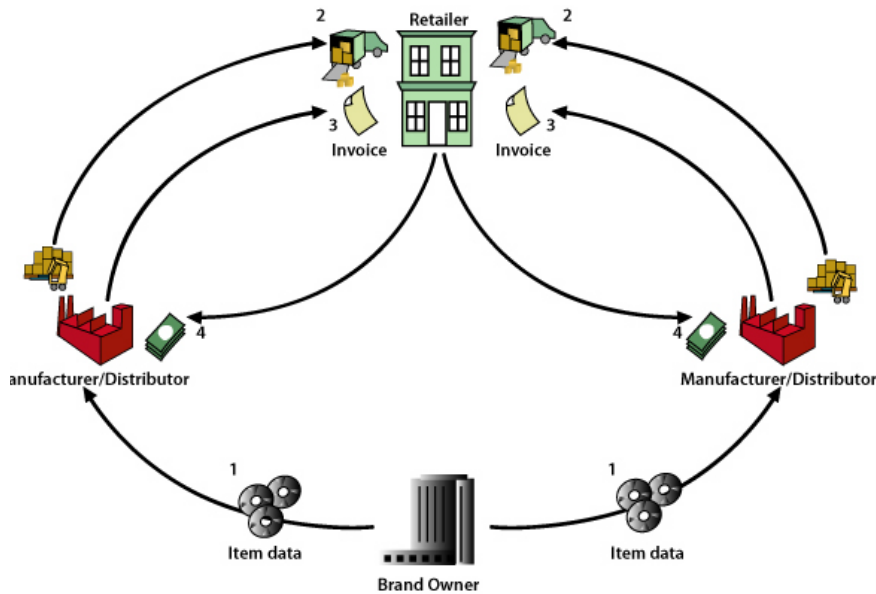

1. The Brand Owner communicates common attributes to the Manufacturer/Distributors.
2. The Manufacturer /Distributors produce and deliver products to the retailer.
3. An Invoice is sent by the Manufacturer/Distributors to the Retailer.
4. The Retailer sends payment directly to the Manufacturer/Distributors.

12.6.4 Item Synchronisation Scenario

As indicated by the business examples described in this section, the Brand Owners will synchronise its Items with the Retailer ([Figure 12-13](#)) as well as the Wholesalers and/or Distributors ([Figure 12-14](#)).

Figure 12-13

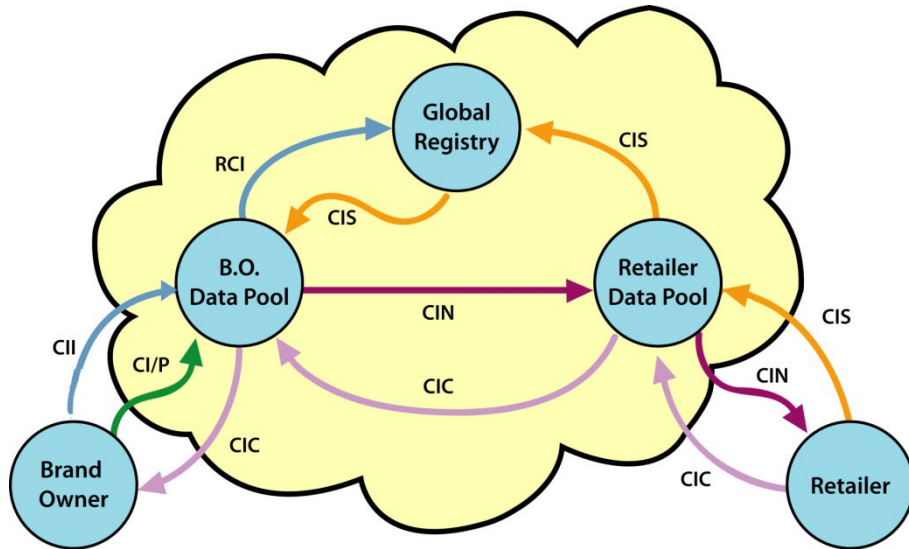
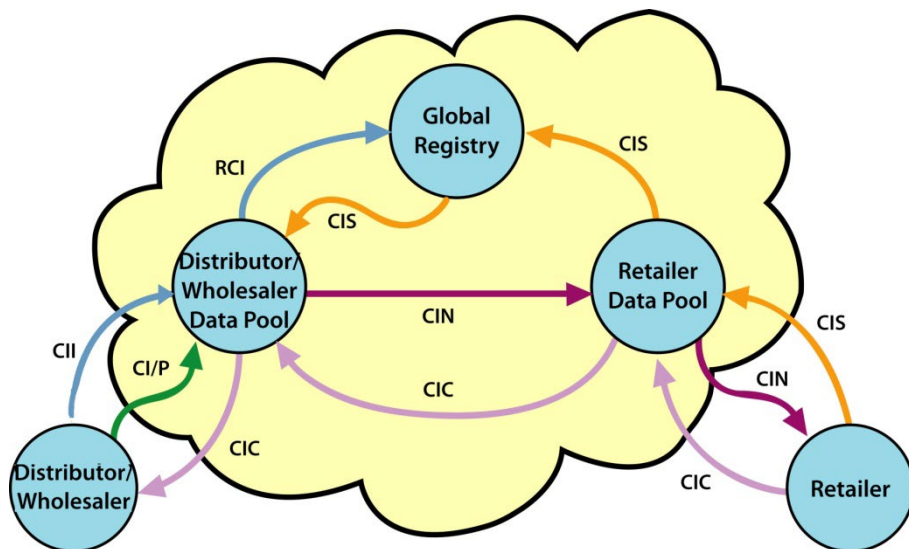

Figure 12-14



13 CIC Response to CIN

This section provides guidance on how the Catalogue Item Confirmation (CIC) Response message should be used in the Global Data Synchronisation Network (GDSN).

The CIC is generated by the Data Recipient (published to GLN) or their data pool in order to inform the Data Source of the status of the GTIN(s) within the Catalogue Item Notification (CIN) that was published as a result of a subscription/publication match.

In the case of a GSMP approved Warning (validation rule - not blocking the synchronisation), a data source data pool will send a CIC with Warning. A source data pool may also send a CIC with Errors (validation rule - blocking the synchronisation).

While it is highly recommended, within GDSN standards the CIC Response message is optional. If this message is sent, it must be generated **at the highest level of the published trade item hierarchy**. The Recipient Data Pool will send an error to the Data Recipient if this message is sent at any other level of the trade item hierarchy. The Data Pool(s) for both the Data Source and the Data Recipient are responsible for maintaining a synch list which is a catalogue of published Trade Item Hierarchies (highest level GTIN) and their response states.

Best practice is to send this message to the Data Source in response to any of these notification types: **New Item**, **Initial Load**, and **Change/Correction**. For CIC State "Review" it is recommended to provide Confirmation Status Code/Description, Additional Confirmation Status Long Description, Corrective Action, and Expected Corrective Information. When the CIC State "Reject" is sent, the Status Code/Description and Corrective Action Code may be included to provide additional clarity.

Best practise is to place the Validation Rule and/or Warning Identifier at the beginning of the Additional Confirmation Status Long Description.

- If an Identifier exists, in the following format: "Identifier: Free Form Text".
- If no Identifier exists, populate the free form text using the guideline "How to write a Validation Rule".

No CIC Response message is expected from the Data Recipient upon receipt of the Delete notification type, as a Delete message indicates the Data Source is no longer synchronising on that trade item hierarchy.

If no CIC Response message is sent by the Data Recipient, any subsequent updates to the trade item hierarchy will continue to be sent from the Source Data Pool.

13.1 Pre-requisite

- Trading partner relationship has been established in GDSN and data recipient has subscribed as appropriate
- Data Recipient has received a Catalogue Item Notification (CIN) from the Data Source

13.2 Examples of CIC Response Messages

The following are a few examples of CIC response messages that include various CIC States, CIC Status codes and CIC Corrective Action codes (when appropriate) for one specific trade item hierarchy.

In each of the below examples it could be the Data Recipient or a Data Pool (on behalf of the recipient) providing feedback via CIC.

Data Source published the following and is used for all examples:

TRADE ITEM HIERARCHY:	GTIN – 20061101234569 – Pallet level (PL) GTIN – 10061101234562 – Case level (CA) GTIN – 00061101234565 – Each level (EA)
INFORMATION PROVIDER GLN:	00123450000359
TARGET MARKET:	840 (United States)

TRADE ITEM HIERARCHY:	GTIN – 20061101234569 – Pallet level (PL) GTIN – 10061101234562 – Case level (CA) GTIN – 00061101234565 – Each level (EA)
MESSAGE TYPE:	Initial Load

13.2.1 Example 1

Data Recipient is in agreement with the data sent in the Initial Load CIN and has synchronised their system with the data provided.

GTIN	20061101234569
CIC State	SYNCHRONISED

13.2.2 Example 2 (Error – Blocking)

Data Recipient has issue with Gross Weight and Width at the Case level:

GTIN	20061101234569
CIC State	REVIEW
GTIN	10061101234562
confirmationStatusCode	CIC100
confirmationStatusCodeDescription	Attribute Analysis Requested
additionalConfirmationStatusLongDescription	VR XXXX: Gross Weight and Width
correctiveActionCode	ACTION_NEEDED (or possibly CORRECTION_MESSAGE)
expectedCorrectiveInformation	Gross Weight and Width at Case level issue Retailer Gross Weight = 4 lb. and Width = 15 in.

Or send twice, which is clearer for each attribute:

GTIN	20061101234569
CIC State	REVIEW
GTIN	10061101234562
confirmationStatusCode	CIC100
confirmationStatusCodeDescription	Attribute Analysis Requested
additionalConfirmationStatusLongDescription	VR XXXX: Gross Weight
correctiveActionCode	ACTION_NEEDED (or possibly CORRECTION_MESSAGE)
expectedCorrectiveInformation	Gross Weight at Case level issue Retailer Gross Weight = 4 lb.
GTIN	10061101234562
confirmationStatusCode	CIC100
confirmationStatusCodeDescription	Attribute Analysis Requested
additionalConfirmationStatusLongDescription	VR XXXX: Width
correctiveActionCode	ACTION_NEEDED (or possibly CORRECTION_MESSAGE)
expectedCorrectiveInformation	Width at Case level issue Retailer Width = 15 in.

13.2.3 Example 3 (Error – Blocking)

Receipt of a New Item publication when an Initial Load publication is desired.

GTIN	20061101234569
CIC State	REVIEW
GTIN	20061101234569
confirmationStatusCode	CIC101
confirmationStatusCodeDescription	Wrong CIN Publication Type
additionalConfirmationStatusLongDescription	Publication was sent as New Item publication and should have been Initial Load publication
correctiveActionCode	INITIAL_ITEM_LOAD_MESSAGE

13.2.4 Example 4 (Error – Blocking)

Unable to synchronise the item due to internal challenges.

GTIN	20061101234569
CIC State	REVIEW
GTIN	20061101234569
confirmationStatusCode	CIC102
confirmationStatusCodeDescription	Unable to Synchronise
additionalConfirmationStatusLongDescription	Unable to synchronise on random weight trade items
correctiveActionCode	NONE

13.2.5 Example 5 (Error – Blocking)

Missing GTIN in published hierarchy.

GTIN	20061101234569
CIC State	REVIEW
GTIN	20061101234569
confirmationStatusCode	CIC103
confirmationStatusCodeDescription	Missing GTIN in Item Hierarchy
additionalConfirmationStatusLongDescription	VR XXXX: Package level GTIN is missing in hierarchy
correctiveActionCode	ACTION_NEEDED
expectedCorrectiveInformation	Resolve with Withdrawal/Repub message choreography

13.2.6 Example 6 (Error – Blocking)

A missing attribute has been identified.

GTIN	20061101234569
CIC State	REVIEW
GTIN	10061101234562
confirmationStatusCode	CIC104
confirmationStatusCodeDescription	Required Attribute for Data Recipient Missing
additionalConfirmationStatusLongDescription	VR XXXX: Battery Size
correctiveActionCode	ACTION_NEEDED (or possibly CORRECTION_MESSAGE)

GTIN	20061101234569
expectedCorrectiveInformation	Battery Size needs to be populated for Digital Cameras

13.2.7 Example 7 (Error – Blocking)

Free form text to be used if there is not an appropriate CIC Status Code.

GTIN	20061101234569
CIC State	REVIEW
GTIN	10061101234562
confirmationStatusCode	CIC999
confirmationStatusCodeDescription	Free Form Text
additionalConfirmationStatusLongDescription	VR XXXX: Brief description of issue
correctiveActionCode	ACTION_NEEDED (or possibly CORRECTION_MESSAGE)
expectedCorrectiveInformation	Description of what needs to be done to resolve the discrepancy

13.2.8 Example 8 (Error – Blocking)

Data Recipient does not want to synchronise on this trade item hierarchy and does not want further updates. Also data Recipient wants to communicate to the Data Source to contact them for additional information. In this example, the Confirmation Status Code, Confirmation Status Code Description and Additional Confirmation Status Long Description fields are optional. However, if CIC999 is used, the Confirmation Status Code Description and Additional Confirmation Status Long Description fields are required.

GTIN	20061101234569
CIC State	REJECTED
GTIN	20061101234569
confirmationStatusCode	CIC999
confirmationStatusCodeDescription	Free Form Text Description User Defined
additionalConfirmationStatusLongDescription	Contact Joe Smith for additional information. joe.smith@yahoo.com (555) 444-2222
correctiveActionCode	CONTACT_TRADING_PARTNER

13.2.9 Example 9 (Error – Blocking)

Multiple issues with New Item publication.

GTIN	20061101234569
CIC State	REVIEW
GTIN	20061101234569
confirmationStatusCode	CIC101
confirmationStatusCodeDescription	Wrong CIN Publication Type
additionalConfirmationStatusLongDescription	Publication was sent as New Item publication and should have been Initial Load publication
correctiveActionCode	INITIAL_ITEM_LOAD_MESSAGE
GTIN	10061101234562
confirmationStatusCode	CIC100

GTIN	20061101234569
confirmationStatusCodeDescription	Attribute Analysis Requested
additionalConfirmationStatusLongDescription	Gross Weight
correctiveActionCode	ACTION_NEEDED (or possibly CORRECTION_MESSAGE)
expectedCorrectiveInformation	Gross Weight at Case level issue Retailer Gross Weight = 4 lb.

13.2.10 Example 10 (Warning – Not blocking)

Data Quality issue detected, GSMP approved Warning.

GTIN	20061101234569
CIC State	REVIEW
GTIN	20061101234569
confirmationStatusCode	CIC999
confirmationStatusCodeDescription	Free Form Text to be populated by the Data Recipient
additionalConfirmationStatusLongDescription	123: WARNING - If multiple product images are provided, then one of them should be identified as the main product image using isPrimaryFile with a value of TRUE, where the referenced file type code = 'PRODUCT_IMAGE'.
correctiveActionCode	WARNING

13.2.11 Example 11 (Warning & Error – Blocking)

Multiple issues with New Item publication. Data Quality issues found, which are both blocking and non-blocking.

GTIN	20061101234569
CIC State	REVIEW
GTIN	20061101234569
confirmationStatusCode	CIC104
confirmationStatusCodeDescription	Required Attribute for Data Recipient Missing
additionalConfirmationStatusLongDescription	VR XXXX: Battery Size missing
correctiveActionCode	ACTION_NEEDED (or possibly CORRECTION_MESSAGE)
confirmationStatusCode	CIC999
confirmationStatusCodeDescription	Free Form Text to be populated by the Data Recipient
additionalConfirmationStatusLongDescription	125: WARNING - Do not use attribute X anymore as it will be deprecated with the next GDSN release.
correctiveActionCode	WARNING

13.3 CIC States

CIC State	Definition	Guidelines
RECEIVED	Has been received by the Data Recipient, but no business decision has been made on the data.	This state provides a notice to the Data Source that the message has been received. This item has been added to the Sync List and any subsequent CIN(s) would be received by the Data Recipient. The Data Recipient should initiate a subsequent CIC message of either "SYNCHRONISED", "REVIEW" or "REJECTED".

CIC State	Definition	Guidelines
REJECTED	Data will no longer be synchronised or updates will no longer be provided.	Indicates that the Data Recipient is not interested in this Item, does not want to/or chooses not to synchronise on this item. With this state all synchronisation is terminated. The Sync List will reflect a "REJECTED" status, indicating that subsequent CIN(s) will no longer be received by the Data Recipient. Confirmation Status Code(s) and/or Corrective Action Code (s) may be included in the CIC. If a Data Recipient would like to update the CIC State from a REJECTED state to another state, the Data Recipient can send another CIC message with the updated CIC state, send a RFCIN (Request For Catalog Item Notification) message (isReloadFlag = false), or request a Republication (CIN) from the Data Source.
SYNCHRONISED	Data is integrated, in synch.	The Data Recipient has synchronised their system with the data provide by the Data Source. This does not necessarily mean that the item is active, completed or available for purchase by the Data Recipient. This item has been added to the Sync List in a synchronised state and any subsequent CIN(s) will be received by the Data Recipient.
REVIEW	The Request to the Data Source to review their data and take action (applies to adds & changes/correct) because the Data Recipient has received discrepant data which they cannot synchronise.	This indicates that further action needs to be taken by the Data Source and/or Data Recipient. The Sync List will reflect a "REVIEW" state and any subsequent CIN(s) will be received by the Data Recipient. Confirmation Status Code(s) and/or Corrective Action Code(s) should be included in the CIC. If the Data Recipient is unable to supply Confirmation Status Code(s) and/or Corrective Action Codes(s) within the CIC, alternate methods outside the network should be used to further clarify the state of review.

13.4 Confirmation Status Codes:

- **Note:** The status codes can only be sent when the CIC State = "REVIEW" or "REJECTED".

Code Name	Code Description	Guidelines
CIC100	Attribute Analysis Requested	Data Recipient is requesting further review of specific attribute(s).
CIC101	Wrong CIN Publication Type	The message publication type was not as expected by Data Recipient.
CIC102	Unable to Synchronise	Data Recipient is not able to synchronise data.
CIC103	Missing GTIN in Item Hierarchy	Data Recipient has identified a missing GTIN level(s) of the published hierarchy.
CIC104	Required Attribute Information for Data Recipient Missing	Data Recipient has identified missing attribute(s) that are mandatory for their specific GDSN implementation.
CIC019	Missing chemical ingredients information	The item is missing required information on chemical ingredients.
CIC020	Incorrect or outdated chemical ingredients information	The chemical ingredients information received is incorrect or outdated for the trade item
CIC200	Incorrect Context	The data sent to the recipient has been sent with an incorrect product context (wrong context for GPC brick).

Code Name	Code Description	Guidelines
CIC999	Free – form text description user defined	The Data Recipient is providing a free-form text explanation for the Confirmation Status Code they have returned to the Data Source or are providing information on additional issues that cannot be identified with a specific Confirmation Status Code. Possible Resolution: If further explanation is required, the Data Source should contact the Data Recipient.

13.5 Corrective Action Code Lists

- **Note:** When sending the Corrective Action Code the best practice is to only send one Corrective Action Code per Trade Item Hierarchy. The GTIN reflected in the confirmation detail should be the highest level of the Trade Item Hierarchy.

Corrective Action Code List	Corrective Action Code List Description
ACTION_NEEDED	Further action is needed. The data recipient will send instructions within the CIC message or contact the data source.
CHANGE_BY_REFRESH_MESSAGE	Please send a Change_by_Refresh message.
CONTACT_TRADING_PARTNER	Please contact the data recipient.
CORRECTION_MESSAGE	Please send a Correction message.
INITIAL_ITEM_LOAD_MESSAGE	Please send an Initial Item Load message, where the attribute isReload equals true.
NEW_ITEM_MESSAGE	Please send a New Item message, where the attribute isReload equals false.
NONE	No action needed.
WARNING	Warning the data submitted may need inspection and possibly correction.

13.6 Additional Resource Information

- For additional information on implementing the CIC message please refer to Catalogue Item Synchronisation Business Message Standard (BMS) – see latest version located on the GS1 website at: <https://www.gs1.org/standards/gdsn>
- For more information on measurement rules, please see [GS1 Package and Product Measurement Standard](#).

14 Display Space Planning

This section explains how to send information through GDSN to enable Space Management. The purpose of this document is to share with the GDSN trading partner community a recommended set of best practices and guidelines around the use attributes for product space planning.

For display space planning, it is important to have accurate dimensions and orientation relative to the space that a product will take on the shelf. The additional data fields and specifications described in this topic will help improve the accuracy of the information received by retailers. These parameters will ensure more products are prepared for shelf/floor space occupation and continued restocking, while minimising the lost sales due to insufficient ‘on-floor’ stock quantities.

14.1 Pre-Requisite

Correct and accurate measurement according to the [GS1 Package and Product Measurement Standard](#).

14.2 When Would I Use This?

This section can be used when a trading partner needs to collect, communicate or interpret attributes associated with space planning.

A manufacturer may have designed a Trade Item with a specific form of retail display in mind. In addition to the basic package measurements, the manufacturer may wish to advise the retailer of additional information which the retailer can integrate directly into a space planning, or planogram, system.

GDSN provides a series of optional attributes which the supplier can use to advise his customer of this data for Space Management.

- **Note:** the final decision of how to display an Item always rests with the retailer. The supplier is only making a suggestion or recommendation.

14.3 How to Send Data for Space Management

The data for Space Management will be sent as part of the normal Catalogue Item Notification (CIN) GDSN message. The Trade Item Display Dimensions class will allow communication of multiple dimensions and additional attributes associated with space management.

Space planning, or planogram, systems require not only an image of the product but also information on the size and position of the item when on display, on shelf or on some other fixture or placed on the floor. The item may have to be assembled for display, which may also change its size.

This guide covers:

- Dimensions
- Packing configuration
- Orientation
- Nesting

It also provides guidance on how to describe “inner packs” and “split cases”.

Each of these types of information can be taken in combination with any other. For example, nesting can be combined with orientation to ensure a nested product is displayed “the right way up”.

- **Note:** for information on making images available via GDSN, please see [GS1 Product Image Specification Standard](#)

14.3.1 Dimensions

This section will cover the requirements on dimensions when prepared for retail display or when out of package or assembled for use.

The product packaging when prepared for display may have different (additional) dimensions from standard dimensions. We need to allow multiple dimensions to be communicated for the Trade Item when these differ from the standard measurements.

- **Important:** The [GS1 Package and Product Measurement Standard](#) continue to apply to all trade items. This section permits additional sets of measurements, but the “standard” measurements according to the GS1 Package and Product Measurement Standard must always be supplied.

14.3.1.1 Attributes for Space Planning

Retailer needs to be aware that trade item might have multiple ways how to be marketed/displayed. For every display option there might be associated set of dimensions. Subsequently the retailer need to understand the display type associated with every set of dimensions.

For packaging levels above base units (which are naturally shelf ready) the retailer needs to know if they are "display ready".

- **Attribute Name: hasDisplayReadyPackaging**

Definition: Indicates that the Trade Item has Display Ready Packaging (also referred to as Shelf Ready Packaging or Retail Ready Packaging). Display Ready Packaging can be exhibited on the floor, a shelf or other location. It may or may not require some modification e.g. to raise a flap. If modifications are necessary, the measurements would be advised for the trade item as prepared for display.

- **Attribute Name: displayDimensionTypeCode**

Definition: Indication to distinguish between different forms of display (for example: in package, retail display and out of package) to correlate to the appropriate dimension measurement.

For items in Display Ready Packaging and for any item whose dimensions change when prepared for final use, these additional dimensions may be required:

14.3.1.2 Definitions of Display Measurement Types

The GDSN code list definitions for **displayDimensionTypeCode** can be found in the [GS1 Global Data Dictionary \(GDD\)](#).

Below, examples of the usage of these codes are provided along with illustrations of each type of display dimensions.

Standard (In Package)

Definition: Product is measured as the package was supplied. In most situations, the trade unit is in the state in which the customer would transport it. In Package is the equivalent of the standard measurements as per the [GS1 Package and Product Measurement Standard](#).

- If the product is supplied with many others in a case or other shipping carton, for example 12 bottles of shampoo in a case, then the measurements are taken once the product is removed from the case. To send the measurements of the whole case, use the GTIN for the case, not the GTIN for the individual product.
- If the product itself is in boxed form, for example a drill or a radio, then the measurements are taken with the product still in its box, as supplied.

In order to be backwards compatible, we suggest that sending no code in the measurement display form attribute means "In Package".

Figure 14-1 Standard (In Package)



Retail Display

Definition: Product is measured as modified for display.

Examples: Display Ready Packaging with fold-up lid or fold-forward front; a box of chocolate bars with display flap; display stand for dishware; merchandise for consumer purchase that is in a 'display' carton that requires modification, such as a product in cans contained within a carton; free-standing displays for a variety of grocery products, candles, decorative items like picture frames); a laptop computer.

Product is measured according to the space it occupies on the shelf.

Figure 14-2 Retail Display



In this example, the case is supplied as shown on the right. When the retailer prepares it for display, the outer packaging is raised and the flap is drawn forward at the bottom. So both the height and the depth have increased. The retailer needs to know the increased dimensions when planning space for this case on the shelf.

Out of Package

Definition: Product is removed from consumer packaging, assembled if necessary for final use and its dimensions measured.

This covers both "out of box" and "assembled".

The merchandiser, as the receiver of the data, may need these measurements in addition to "in package" if one instance of the product is taken out of box for display and other instances are left in box for purchase.

Examples: Computer desk; entertainment centre; microwave oven; lawnmower; a floor cleaner; a grouping of table and chairs; stove; telephone; camera; large appliance (e.g. washing machines); small appliance (e.g. food processors).

Figure 14-3 Out of Package Measurement Type (Floor Cleaner as supplied in a box)



Figure 14-4 Out of Package Measurement Type (Floor Cleaner removed from a box and ready for use)



In [Figure 14-5](#), self-assembly furniture is normally supplied in a “flat-pack” box. After assembly it will have different dimensions:

Figure 14-5 Out of Package Measurement Type (flat-pack” box)



Display Item Hanging

Definition: Item has been assembled for display and it has been set to hang from a frame or ceiling. The product may have a hanger in some cases (e.g. apparel).

The retailer needs to know how the item is presented, if hanging but not hanging from a shelf, and what its dimensions are when displayed hanging in this way.

Figure 14-6 Display Item Hanging



Display Item Hanging

In the example from [Figure 14-6](#) there are a number of display lamps hanging directly from the ceiling, for which the code "DISPLAY_ITEM_HANGING" would be used. Note that none of the lamps is hanging from a shelf.

Display Item Hanging From Shelf

Definition: Item has been assembled for display and it has been set to hang from the shelf itself. The product may have a hanger in some cases.

The retailer needs to know how the item is presented, if hanging from a shelf, and what its dimensions are when displayed hanging in this way.

Figure 14-7 Display Item Hanging From Shelf



On [Figure 14-7](#) above we can see on the upper section of the shelf a number of show/display items being exhibited hanging from the shelf. On [Figure 14-8](#) below, we find more examples of display products being exhibited hanging from a shelf.

Figure 14-8 Display Item Hanging From Shelf (Additional Examples)

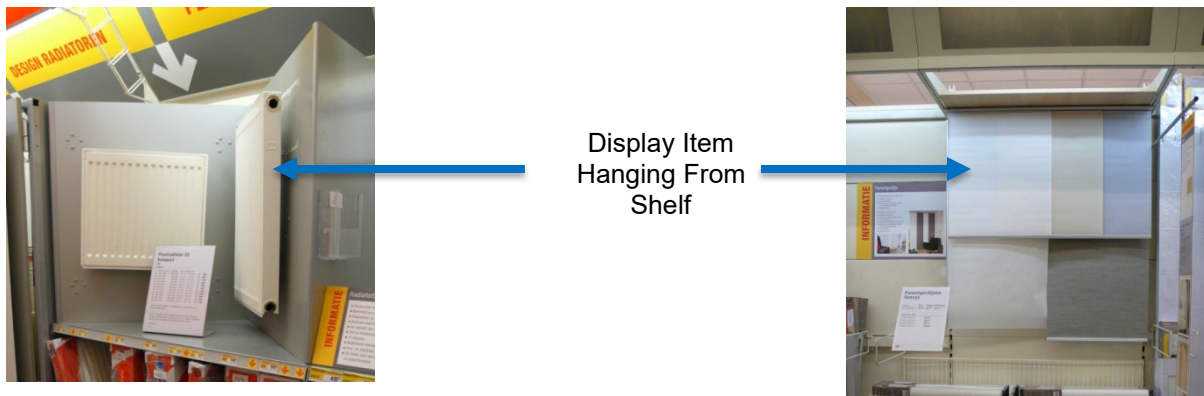

Display Item Standing

Definition: Item has been assembled for display and it has been placed for display directly on the floor.

The retailer needs to know how the item is presented, if standing on the floor, and what its dimensions are when displayed standing in this way.

In the showroom shown on [Figure 14-9](#) below there are a number of display items being exhibited standing directly on the sales floor, like the red lamp, the coffee tables, and the sofa.

Figure 14-9 Display Item Standing

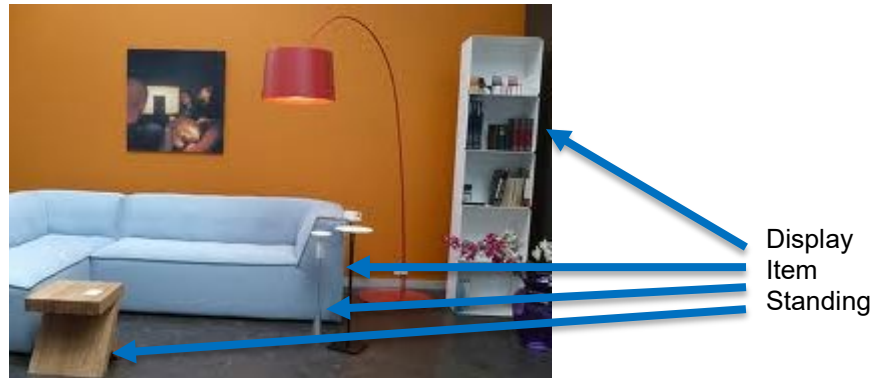

Display Item Standing On Shelf

Definition: Item has been assembled for display and it has been placed for display on the shelf.

The retailer needs to know how the item is presented, if standing on a shelf, and what its dimensions are when displayed standing in this way.

The display items in [Figure 14-10](#) (the out-of-box vacuum cleaners) are presented standing on shelf.

Figure 14-10 Display Item Standing On Shelf



Display Item Folded On Shelf

Definition: Item has been folded before being placed on display in a shelf or other container.

The retailer needs to know how the item is presented, if folded on a shelf or into a display case or other form of display, and what its dimensions are when folded and displayed in this way.

On the example below items are shown folded on a shelf.

Figure 14-11 Display Item Folded On Shelf



Maximum Door/Drawer/Lid Clearance

Definition: Item is displayed with the door or lid open to require the maximum clearance. This applies to refrigerators, dishwashers, ovens, washers, dryers, furniture, and laptop computers.

The retailer needs to know how much space the item will take when displayed fully open.

Figure 14-12 Maximum Door/Drawer/Lid Clearance

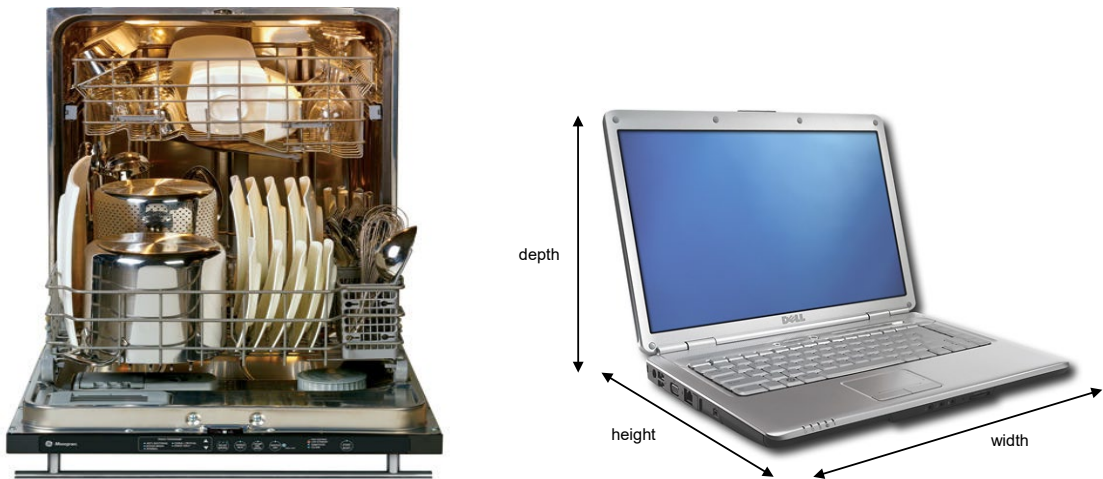

Maximum Door/Drawer/Lid Clearance, With Handle

Definition: Item is displayed with the door or lid including its handle open to require the maximum clearance. This applies to refrigerators, dishwashers, ovens, and furniture.

The retailer needs to know how much space the item will take when displayed fully open, allowing for the extra space the handle on a door or lid will take.

Figure 14-13 Maximum Door/Drawer/Lid Clearance, With Handle



14.3.2 Examples

Example 1: A blender is contained in a box for consumer purchase. The blender is normally displayed without the box by the Retail store. Without removing the box, the blender is not readily visible to the consumer. The blenders are purchased by the case from the Manufacturer.

tradeItem Unit Descriptor	Description	GTIN	has DisplayReady Packaging	display Dimension TypeCode	Dimensions		
					Height	Width	Depth
CS	6 Blenders	130410900048214			14 in	13 in	19 in
EA	1 Blender	030410900048217			12 in	6 in	6 in
TradeItemDisplayDimensions				Out of Box	11.2 in	5.3 in	4.8 in

Example 2: A toy car is contained in a box for consumer purchase. The box that contains the toy car has a flap that can be raised to enable the car to hang on a peg bar. Some Retail locations also choose to display the car out of the box to persuade consumers. The toy cars are purchased by the case from the Manufacturer.

tradeItem Unit Descriptor	Description	GTIN	has DisplayReady Packaging	display Dimension TypeCode	Dimensions		
					Height	Width	Depth
CS	12 Toy Cars	12345900048215			127 mm	1270 mm	1575 mm
EA	1 Toy Car	02345900048218			101 mm	127 mm	101 mm
TradeItemDisplayDimensions				Out of Box	152 mm	127 mm	101 mm
TradeItemDisplayDimensions				Retail Display	95 mm	114 mm	95 mm

Example 3: A candy bar is sold to the consumer in an outer wrapper. The candy bar can be placed on a shelf for display to consumers. The candy bars are purchased by the case from the Manufacturer. The case is a ready merchandised unit that contains a pull strip and graphics which

make it easy to identify, easy to open, easily placed and disposed of, allowing the optimisation of retail store replenishment and enhanced consumer visibility. The case changes dimensions when it is prepared for placement on the shelf.

tradeItem Unit Descriptor	Description	GTIN	has DisplayReady Packaging	display Dimension TypeCode	Dimensions		
					Height	Width	Depth
CS	60 Candy Bars	1334590004821 4	Y		6 in	7 in	20in
TradeItemDisplayDimensions				Retail Display	5 in	6.5 in	20 in
EA	1 Candy Bar	0334590004821 7			1 in	5 in	1.5 in

Example 4: A can of dog food is supplied ready for consumer purchase. The cans are purchased by the case from the Manufacturer. The case is a ready merchandised unit that contains a fold-forward front to dispense the cans and graphics which make it easy to identify, easy to open, easily placed and disposed of, allowing the optimisation of retail store replenishment and enhanced consumer visibility. The case does change dimensions when it is prepared for placement on the shelf.

tradeItem Unit Descriptor	Description	GTIN	has DisplayReady Packaging	display Dimension TypeCode	Dimensions		
					Height	Width	Depth
CS	36 Cans of dog food	14345900048213	Y		280 mm	230 mm	355 mm
TradeItemDisplayDimensions				Retail Display	280 mm	230 mm	430 mm
EA	1 Can of dog food	04345900048216			86 mm	71 mm	86 mm

Example 5: A self-assembly bookcase is supplied in a package, ready for purchase and assembly by the consumer. Once assembled at home the bookcase is a completely different size and shape to the original package.

tradeItem Unit Descriptor	Description	GTIN	has DisplayReady Packaging	display Dimension TypeCode	Dimensions		
					Height	Width	Depth
EA	1 Bookcase self-assembly	15345900048212			130 mm	300 mm	2050 mm
TradeItemDisplayDimensions				Out of Box	2020 mm	800 mm	280 mm

14.3.3 Packing Configuration

Retailers need to know the number of consumer trade items, which are contained in the space available within the Display Ready Packaging unit (e.g. tray or dolly). This is used when developing the planogram.

This is helpful because in the space management tools the retailer needs to know and manage the number of facings of consumer trade items, in addition to the dimensions, in order to optimise visual impact and generate sales.

To see how this can be helpful, see this example of a planogram diagram. The photo-montage uses small images of the products to build up a picture of how the retail shelving unit can look when fully stocked. For every product, the space planner must decide how many units will be placed on the shelf. With Display Ready Packaging, the whole case will be placed onto the shelf, so the space planner needs to know how many units in the case will face the front.

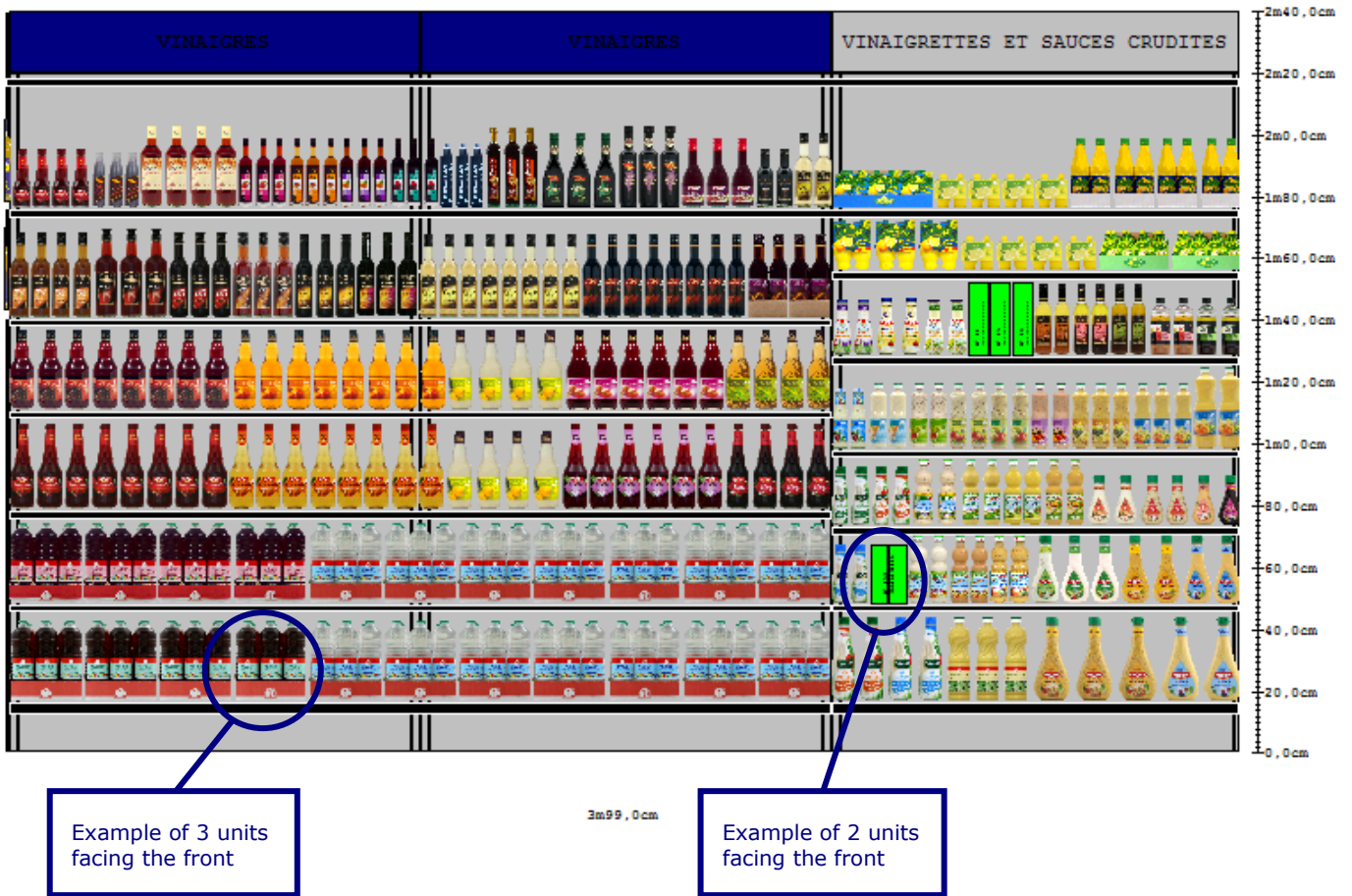

- The number of child Trade Items in the height is expressed, in the trade item, by the attribute **quantityOfCompleteLayersContainedInATradeItem**
- The number of child Trade Items in the width is expressed, in the trade item, by the attribute **tradeItemCompositionWidth**
- The number of child Trade Items in the depth is expressed, in the trade item, by the attribute **tradeItemCompositionDepth**
- **Note:** The default unit of measure to express a quantity for **tradeItemCompositionWidth** and **tradeItemCompositionDepth** is "UN" for unit; for example 6 UN.

Data recipients need to know that the Display Ready Packaging unit is packed irregularly if either one of the following conditions is met:

- When Display Ready Packaging unit dimensions cannot be recalculated from the child trade items dimensions.
- When the number of child trade items cannot be determined by the Display Ready Packaging unit dimensions.

This information is important to disable some automatic validation rules when an irregularly-packed Display Ready Packaging trade item message is received in the data recipient's system. For example, this information can be used by the manufacturer to indicate that the number of child trade items in the height, width or depth is not accidentally missing but will not be sent.

Example 1: A case with the option to present either three or four units to the front

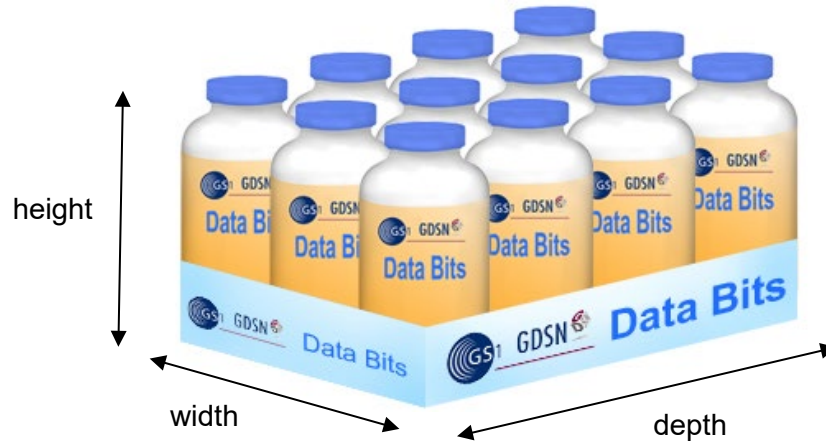

- Number of child Trade Items in the Width: 3
- Number of child Trade Items in the Depth: 4
- Number of child Trade Items in the Height: 1

In this example, the space planner will want to decide whether to have 3 or 4 facing the front of the shelf. As this case is packed in a regular rectangular format, **isTradeItemPackedIrregularly** is set to FALSE.

Example 2: Dimension of Display Ready Packaging is not consistent with the sum of the dimensions of the child Trade Items

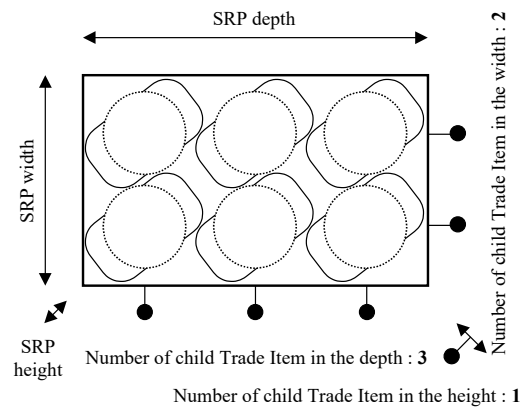

The angle of the jars packed in the case means that the depth is less and width is more than would have been expected from the dimensions of each jar. It is therefore important to alert the space planner by setting: **isTradeItemPackedIrregularly: TRUE**

Example 3: Number of child Trade Items per dimension is not consistent with the total number of the child Trade Items

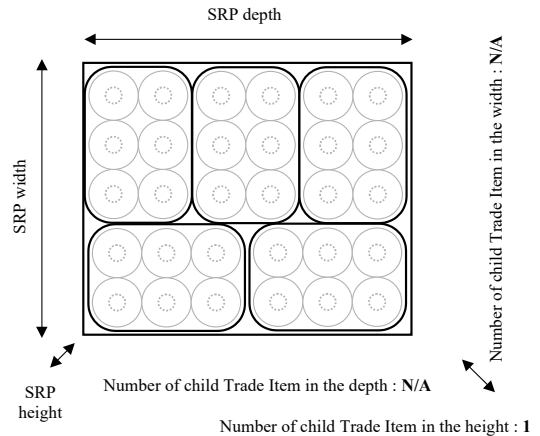

In this example, the attributes x and y cannot be sent as they cannot be decided. From one side it is 2 and from the other side it is 3.

isTradeItemPackedIrregularly : TRUE

Example 4: Irregular display or dimension of the child Trade Items

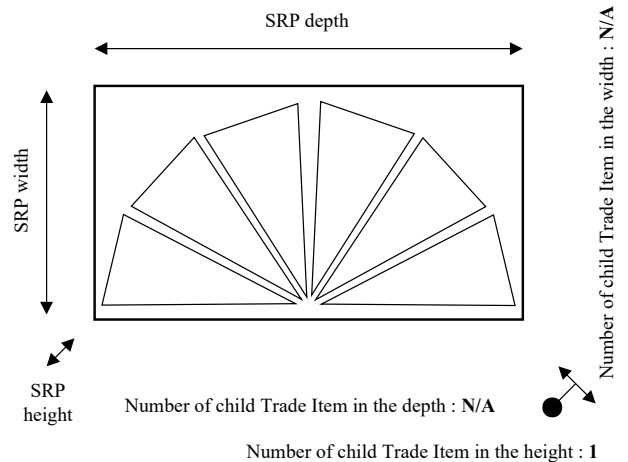

In this example, the attributes x and y cannot be sent as they cannot be decided, as the cheese segments are placed in a semi-circular arrangement.

isTradeItemPackedIrregularly : TRUE

14.3.4 Orientation

By orientation we mean “which way up” the product can be placed.

The [GS1 Package and Product Measurement Standard](#) imply an orientation by using phrases such as “default front” and “natural base” – but for some Trade Items the manufacturer may prefer to recommend one or more different orientations.

- **Note:** the final decision of how to display an Item always rests with the retailer. The supplier is only making a suggestion or recommendation.

To meet this business requirement, GDSN supports the following optional functionality:

- For each Trade Item, the manufacturer may recommend one or more orientations for display;
- If the manufacturer supplies more than one recommended orientation, he may communicate his relative preferences for each orientation;
- This optional functionality may apply to both consumer and non-consumer items.

14.3.4.1 Why is Orientation important?

For shelf planning it is important to have both accurate dimensions and also to know the possible orientations. The [GS1 Package and Product Measurement Standard](#) specify how to measure the dimensions but they do not include the preferred orientation(s) when on retail display. Only by knowing both the measurements and the orientation can the space that the product will take on the shelf be fully known. This will help improve the accuracy of the information received by retailers.

If the shelf dimensions are not available in GDSN then trading partners have to depend on additional (non-standard) processes to obtain it. The optional functionality will allow for more accurate product space requirements by maximising the product space ratio. Increasing the product count available on the retail floor will decrease 'out-of-stocks' where space is limited. Shelf space management processes will be more accurate, giving the retailer a more complete retail space analysis.

14.3.4.2 Three step process

- **Note:** Always start from the measurements taken according to the [GS1 Package and Product Measurement Standard](#). These are based on identifying the default front face (for consumer items) and identifying the natural base (for non-consumer items). The dimensions of Height, Width and Depth are measured accordingly.

If the orientation according to the [GS1 Package and Product Measurement Standard](#) does not match the orientation(s) suggested for display, then the supplier may recommend the display orientation(s):

1. Determine which face will be turned to the front when displayed for sales



- The numbering of faces is as determined for the [GS1 Product Image Specification Standard](#). This is consistent with planogram images.

Number	Face	Description
.1	Front	The front face when measured
.2	Left	The face to the left of the front, when measured.
.3	Top	The face on the top, when measured.
.4, .5, .6	n/a	<i>(These faces intentionally not used)</i>
.7	Back	The face at the back, when measured.
.8	Right	The face to the right of the front, when measured.
.9	Bottom	The face on the underside, when measured.

2. Determine whether the “front for display” face needs to be rotated
3. If there is more than one recommended orientation, the supplier may specify an order of preference – this is optional.

- **Note:** For the purposes of orientation of non-consumer items, assume that the ‘default front face’ will always correspond to the ‘width’ (shortest horizontal side after the natural base has been identified). If the manufacturer has designed the non-consumer item to be displayed with the longest horizontal side turned to the front, specify the orientation accordingly, using the steps below.
- **Note:** It is possible that when prepared for display the dimensions of the trade item are altered, for example by removing a cover or by erecting a fold-up or fold-forward flap. Please see section [14.3.1 Dimensions](#) for guidance on how to communicate the resulting dimensions.

14.3.4.3 Examples

In this section real examples are shown to illustrate how the attributes associated with orientation are used to communicate the supplier’s recommendations to the customer.

Example 1: Orientation as per the GS1 Package and Product Measurement Standard



Orientation Attribute	Value
Orientation Type	FRF_000 = Front face, rotate clockwise 0°
Orientation Preferences Sequence	<no data sent>

- **Note:** In this example, no rotation is recommended. The same effect could be obtained by not sending any Orientation information. As only one orientation is sent, the data source does not need to send a Preferences Sequence.

Example 2: Book

A book can typically be displayed in one of three positions:

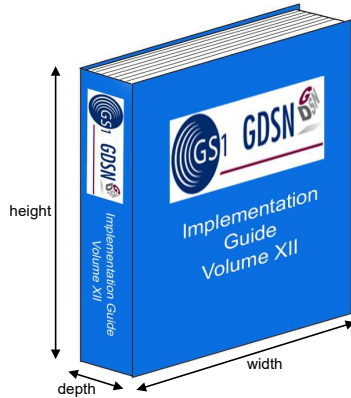

Orientation Sequence 1:
As measured: with the largest face to the front



Orientation Sequence 2:
Rotate left to show spine, remains upright



Orientation Sequence 3:
Rotate left to show spine and rotate left to lie flat

The data source has the option of specifying which of these orientations is preferred. For the purpose of this example, we will assume he would most like to display the largest surface, but allows spine (upright) as a first alternative, and spine (lying flat) as a further option.

Orientation Attribute	Value
First instance of TradeItemOrientation information	
Orientation Type	FRF_000 = Front face, rotate clockwise 0°
Orientation Preferences Sequence	1
Second instance of TradeItemOrientation information	
Orientation Type	LEF_000 = Left face, rotate clockwise 0°
Orientation Preferences Sequence	2
Third instance of TradeItemOrientation information	
Orientation Type	LEF_270 = Left face, rotate clockwise 270°
Orientation Preferences Sequence	3

Example 3: Boxed item with multiple orientations

Some items sold in small boxes can be displayed in a number of orientations. This typically includes breakfast cereals, boxes of biscuits or cookies, and some boxed culinary items. As well as the front and left faces, they are often displayed lying on the back face with the top face on display to the shopper. Also, they may have a front face in vertical (portrait) format and on the back face the same artwork showing in a horizontal (landscape) format.

This example shows a box of cookies with four possible orientations (front, back, side and base).

- As measured: with the largest, vertical, face to the front



- Rotated to show left side, and laid flat



- Turned to back, and rotated to show horizontal (landscape) format



- **Note:** When turning the item to the back side, for the purposes of describing the orientation, keep the base on the ground (i.e. rotate around a vertical axis, showing first the left side and then the back side). Do not “flip” forward twice, rotating through a horizontal axis. If the back side (now facing the front) then needs further rotation, this can be described with the codes available.
- Rotated forward to show top side (“fall forward”)



The data source has the option of specifying which of these orientations is preferred. For the purpose of this example, we will assume he would most like to display the largest surfaces (portrait, then landscape), with lying flat with long side to the front as a first alternative, and lying flat with short side to the front as a further option.

Orientation Attribute	Value
First instance of TradeItemOrientation information	
Orientation Type	FRF_000 = Front face, rotate clockwise 0°
Orientation Preferences Sequence	1
Second instance of TradeItemOrientation information	
Orientation Type	LEF_000 = Left face, rotate clockwise 0°
Orientation Preferences Sequence	3
Third instance of TradeItemOrientation information	
Orientation Type	BAF_270 = Back face, rotate clockwise 270°
Orientation Preferences Sequence	2
Fourth instance of TradeItemOrientation information	
Orientation Type	TOF_000 = Top face, rotate clockwise 0°
Orientation Preferences Sequence	4

Example 4: Large flexible bag of dog food, lying flat

This is a large and heavy (8.0Kg, 17.6lb) flexible bag. It is sold lying flat (default face on top, facing up). It may be orientated for retail display with either the left side panel or the bottom facing towards the consumer.



As measured



As displayed lying flat (recommended)

The data source has the option of specifying which of these orientations is preferred. For the purpose of this example, we will assume he would most like to display the left side panel with the writing upright; he allows the short (bottom) side facing out to the front as a further option.

Orientation Attribute	Value
First instance of TradeItemOrientation information	
Orientation Type	LEF_270 = Left face, rotate clockwise 270°
Orientation Preferences Sequence	1
Second instance of TradeItemOrientation information	
Orientation Type	BOF_000 = Bottom face, rotate clockwise 0°
Orientation Preferences Sequence	2

- **Note:** In this example, the manufacturer does not recommend to display the product in the orientation implied by the [GS1 Package and Product Measurement Standard](#). So orientationType = "FRF_000" is not given as an option.

Example 5: Frozen food product

Frozen products are typically displayed for sale either in upright freezers (where the item is often display standing upright) or in chest (bunker) freezers (where the item is usually displayed lying flat).

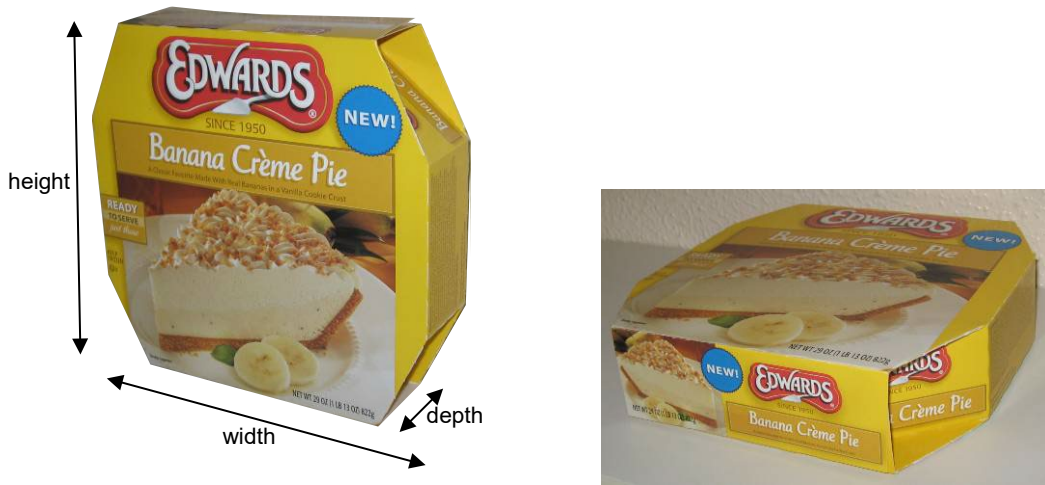

The data source has the option of specifying which of these orientations is preferred. For the purpose of this example, we will assume he chooses to express no preference.

Orientation Attribute	Value
First instance of TradeItemOrientation information	
Orientation Type	FRF_000 = Front face, rotate clockwise 0°
Orientation Preferences Sequence	<no data sent>
Second instance of TradeItemOrientation information	
Orientation Type	BOF_000 = Bottom face, rotate clockwise 0°
Orientation Preferences Sequence	<no data sent>

Example 6: Board game

Board games are normally displayed lying flat, but they will be measured with their main selling face to the front. When lying flat, they could have their long side or their short side facing the front.



The data source has the option of specifying which of these orientations is preferred. For the purpose of this example, we will assume he chooses to express no preference.

Orientation Attribute	Value
First instance of TradeItemOrientation information	
Orientation Type	FRF_000 = Front face, rotate clockwise 0°
Orientation Preferences Sequence	<no data sent>
Second instance of TradeItemOrientation information	
Orientation Type	BOF_000 = Bottom face, rotate clockwise 0°
Orientation Preferences Sequence	<no data sent>
Third instance of TradeItemOrientation information	
Orientation Type	LEF_270 = Left face, rotate clockwise 270°
Orientation Preferences Sequence	<no data sent>

Example 7: Ice Cream tub

Ice cream products sold in a tub may have the lid of the tub as the largest surface area used to market the product. For these items the lid is the default front. But it will generally be displayed standing on the base of the tub, not on its side.



The data source has the option of specifying which of these orientations is preferred. For the purpose of this example, we will assume he recommends the tub should stand on its base (as on the left in the picture above).

Orientation Attribute	Value
Orientation Type	BOF_000 = Bottom face, rotate clockwise 0°
Orientation Preferences Sequence	<no data sent>

- **Note:** As only one orientation is sent, the data source does not need to send a Preferences Sequence.

Example 8: Drinks can

Carbonated drinks sold in cans sometimes have the brand name running along the length of the can. If the manufacturer chooses to measure the can in accordance with the direction of the brand lettering (and in some retail displays, cans are positioned “lying down”), the manufacturer may offer an alternative orientation with the can standing upright on its natural base.

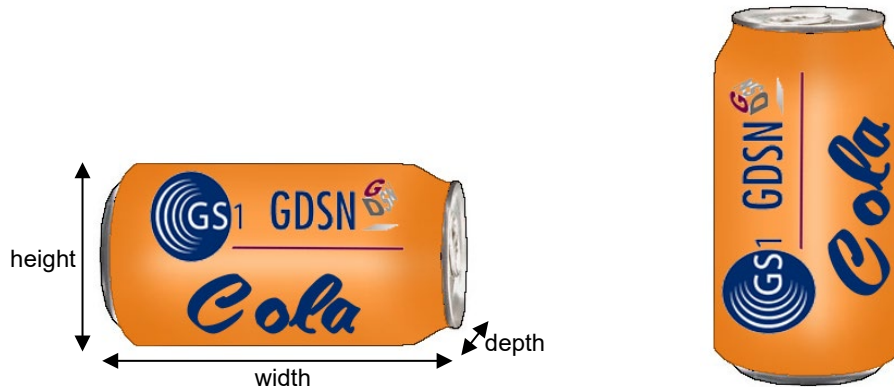

The data source has the option of specifying which of these orientations is preferred. For the purpose of this example, we will assume he prefers the can to stand upright.

Orientation Attribute	Value
First instance of TradeItemOrientation information	
Orientation Type	FRF_270 = Front face, rotate clockwise 270°
Orientation Preferences Sequence	1
Second instance of TradeItemOrientation information	
Orientation Type	FRF_000 = Front face, rotate clockwise 000°
Orientation Preferences Sequence	2

Example 9: Laptop



A laptop is supplied in a cardboard shipping box. This is the item sold at the retail point-of-sale.



When removed from the box, the major selling face (logo) of the laptop is on the front and the hinge is at the bottom.



When laid flat for use, the face with the logo is on top and the hinge has been moved to the back.

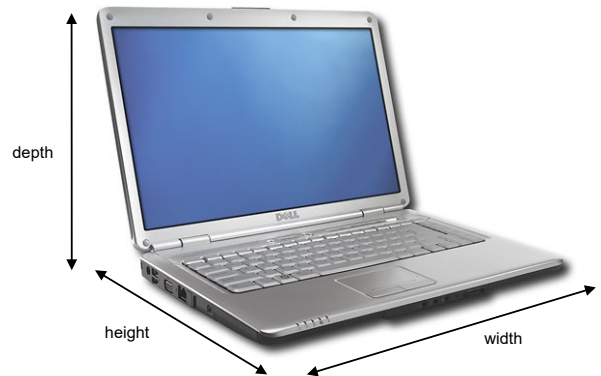

Furthermore, when opened for use, the dimensions change (see section [14.3.1](#)).

To convey this complex information, the Data Source must send both additional Dimensions information and also Orientation information.

Measurement Attributes	Value
These are the measurements of the shipping case.	
Width	408 MMT (millimetres)
Depth	357 MMT (millimetres)
Height	191 MMT (millimetres)
TradeItemDisplayDimensions Attribute	Value
First instance of TradeItemDisplayDimensions information =	
displayDimensionTypeCode	OUT_OF_PACKAGE (removed from consumer packaging, with logo facing front)
displayDimensions.width	337 MMT (millimetres)
displayDimensions.depth	39 MMT (millimetres)
displayDimensions.height	242 MMT (millimetres)
Second instance of TradeItemDisplayDimensions information	
displayDimensionTypeCode	RETAIL_DISPLAY (with lid opened for use)
displayDimensions.width	337 MMT (millimetres)
displayDimensions.depth	240 MMT (millimetres)
displayDimensions.height	350 MMT (millimetres)

Measurement Attributes	Value
Orientation Attribute	Value
First instance of TradeItemOrientation information	
Orientation Type	TOF_180 = Top face, rotate clockwise 180°
Orientation Preferences Sequence	<no data sent>

- **Note:** As only one orientation is sent, the data source does not need to send a Preferences Sequence.

Example 10: Non-consumer item rotated for display

The non-consumer trade item tray is measured on its natural base, with the Width measuring the shorter side, and the Depth measuring the longer side. In this example, it is designed to be displayed with the longer side facing the front, so it must be rotated either to the right or the left when planning the display space.



Orientation Attribute	Value
Orientation Type	RIF_000 = Right face, rotate clockwise 0°
Orientation Preferences Sequence	<no data sent>

- **Note:** As only one orientation is sent, the data source does not need to send a Preferences Sequence.

Example 11: Non-consumer Item: (Case warehoused and transported for strength, but displayed in a different orientation)

A trade item may be warehoused and transported in one orientation, so that the natural base for the case is as warehoused and transported. An example is when the consumer item is packed in small cardboard tubes, which are liable to crushing if the cases are stacked with the tubes lying horizontally. The manufacturer, therefore, stacks the cases so that the tubes are oriented vertically. When it is displayed for retail sale, the manufacturer may recommend that the tubes lie horizontally, for instance to optimise the branding marked on the product.

14.3.4.4 Notes on Orientation

- **Note:** the supplier can suggest more than one orientation, and can express a preference between the orientations.
- **Important:** It is essential, given that the measurements are according to the [GS1 Package and Product Measurement Standard](#), the images are following the same guidelines. This is specified in the GS1 Image standards. So when rotating the orientation of the product, the image is also rotated or an image of the face now rotated to the front is used.

- **Note:** Multi-lingual packaging with unilingual facings. For example, in Canada the product may have one selling face in French and a different selling face in English. For these packaging types, the intended Target Market may impact the imaging front face choice.

14.3.5 Nesting

The purpose of this section is to share with the GDSN trading partner community a recommended set of best practices and guidelines around the use of nesting dimensions for the optimal allocation of shelf space.

This manual provides clarification and recommended practices for utilising nesting properties properly in the context of building on the current accurate dimensional data for products. It also supports the recommendations identified in the *GS1 Data Quality Framework*, published in 2005.

GS1 Member Organisations provide excellent training and information on interpreting and applying the [GS1 Package and Product Measurement Standard](#), which form the foundation for accuracy of physical dimensional data. In addition, many GS1 Member Organisations provide services to audit product data and communicate the results between trading partners. Additional details regarding the rules for package measurement can be found in the [GS1 Package and Product Measurement Standard](#).

14.3.5.1 Benefits and Advantages of Use

Product nesting dimensions and supplementary information allow trading partners to optimise the application of shelf space while maintaining the integrity of the packaging measurement guidelines. Some specific benefits of using nesting attributes are as follows:

- Nesting dimensions allow businesses to accurately allocate shelf space while reducing out of stocks.
- Three dimensional nesting measurements will link nesting data with product rotation. Multiple axis implementation of acquired data will allow more flexibility in shelf and product configurations.
- Peg nesting is now calculable for increased on floor stock levels.
- Application of positive/negative nesting parameter allows a more realistic image adaptation of the stock layout.

Adherence to the practices identified in this document is an important step to establishing and maintaining an optimised shelf management system.

14.3.5.2 Definition of Nesting

nest-ing : To fit together in a stack.

Nesting is the dimensions of the space required by the addition of identical items, in identical directional orientation, where the total is less than the sum of the individual dimensions.

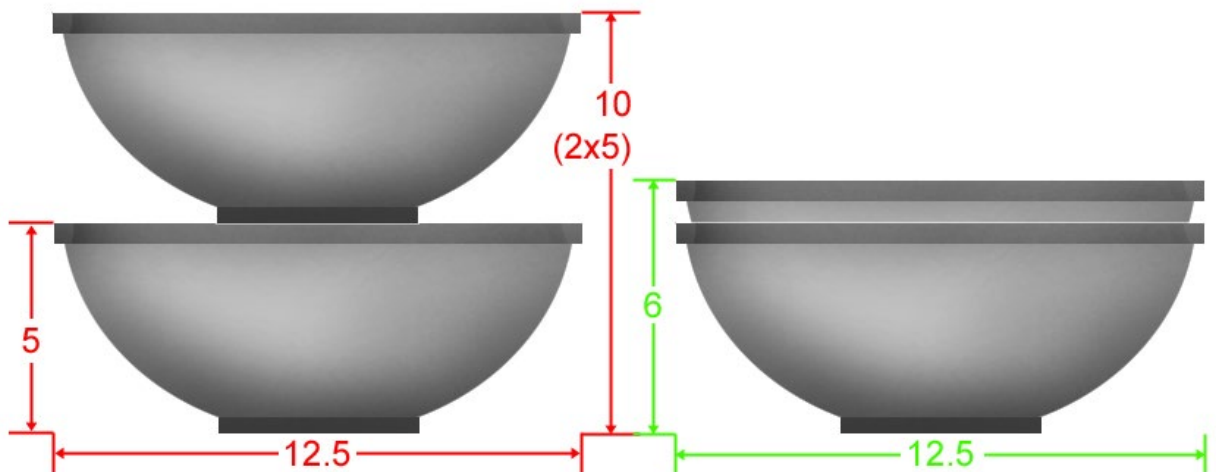

*In the example above the nesting dimensions would be H: 1; W: 0; D: 0. this dimension is relative to the additional space required by the addition of more identical items.

14.3.5.3 Positive and Negative (Type)

Positive and negative nesting is a determination as to the application of the space planning images relative to the nesting dimension(s). This in no way indicates a direction or method of calculation, but merely how the images interact with each other to present an accurate visual reference.

- Positive nesting is an arrangement where the higher item fits over and partially obscures the lower one.. The nesting dimension is the amount of image to be added for the visual representation of shelf space. The term *Positive Nesting* is used due to the fact that we are adding to the base product image.



- Negative nesting is where the additional (or secondary) product is the image that remains whole, and the previous products are partially obscured by each subsequent additional item. The nesting dimension is the amount of the base/previous image remaining for the visual representation of shelf space. The term *Negative Nesting* is used due to the fact that we are subtracting from, or covering, the original product image.

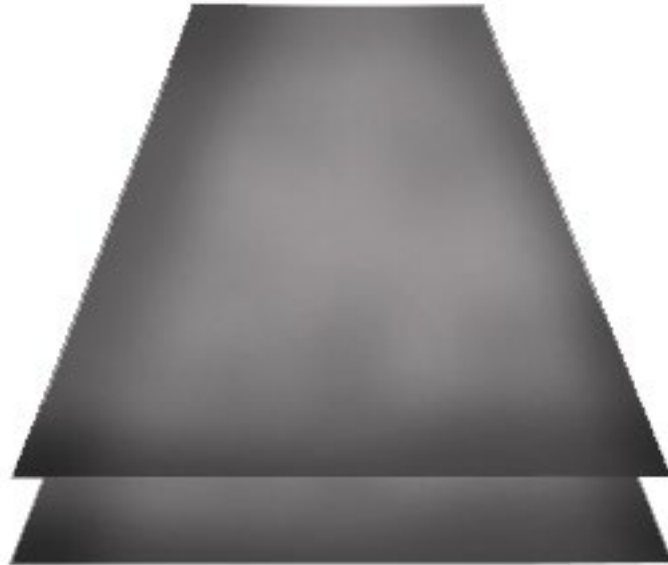

- **Note:** These two definitions are not only for vertical nesting scenarios, but also for horizontal (most commonly peg based) uses.

14.3.5.4 Vertical and Horizontal Nesting (Direction)

This data field indicates how the nesting is applied to the product. When coupled with the dimensions that are affected by nesting it can convey an accurate actual space required when the item is rotated.

** There are certain cases where the nesting can be applied in both a vertical and horizontal positioning, for these cases the direction will be indicated as 'both'.*

- Vertical nesting is the stacking of products where the greatest increase in dimension is vertical in nature

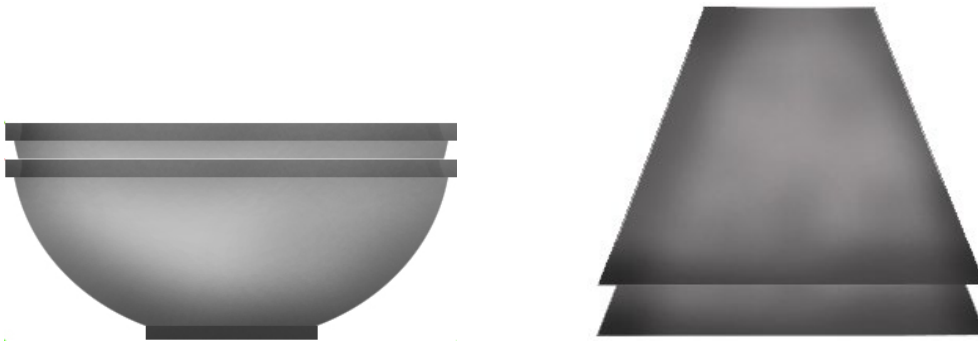

Horizontal nesting is primarily based on peg products and the actual amount of stock that can be placed in that environment.

**Due to the peg, the vertical dimension cannot change.*

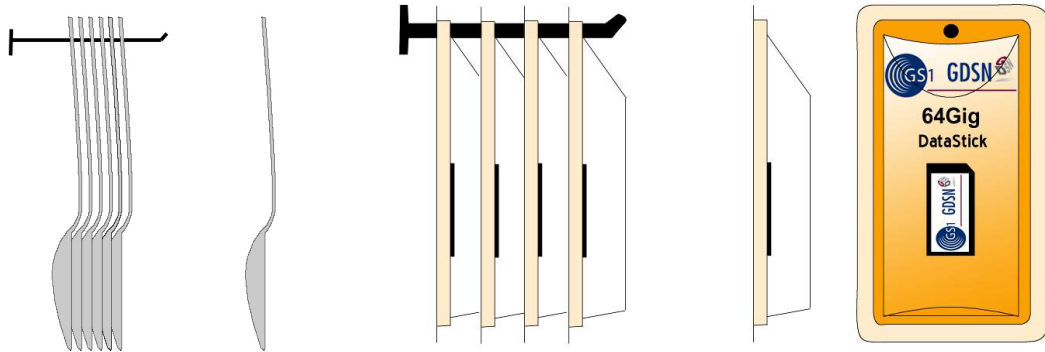

- In some instances the nesting may increase multiple dimensions (in this case the directional determination will be vertical).

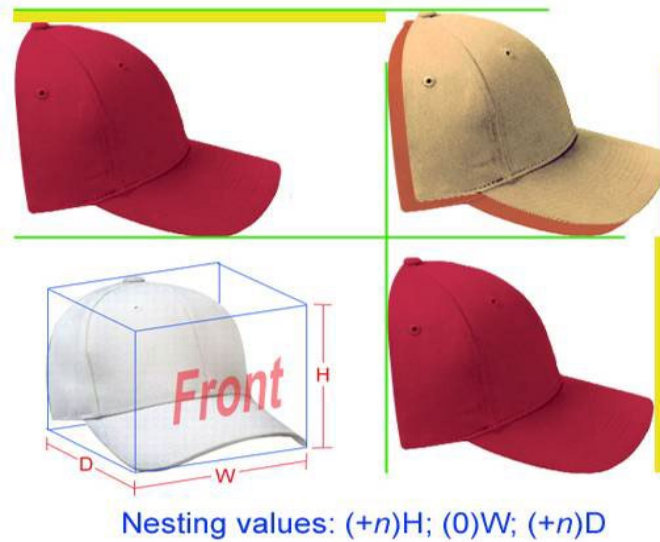

In the example above, you can see how an item can alter two dimensions with nesting, in this case both height and depth.

14.3.5.5 Nesting Measurement Procedures

The basic equation to determine the nesting value is:

$$N = \frac{(A-B)}{Tc - 1}$$

- **A = Actual/total dimension**
- **B = Base dimension (single unit)**
- **Tc = total count**
- **N = nesting value**

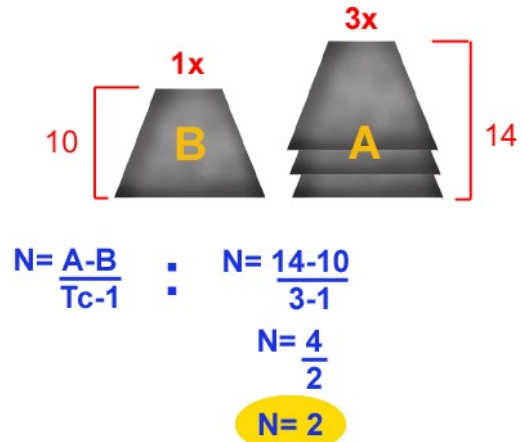

Begin with selecting multiple samples of the trade item to be measured. Each sample must share the same GTIN.

Using the measurement procedures identified below, perform the measurements of all trade item dimensions accordingly. This is your base height.

Repeat the measurement procedures below on a set of stacked/pegged products and record the dimensions, and quantity of items in the stack, accordingly. This is your actual height and total count.

Measurement procedures should strictly adhere to the guidelines published in the [GS1 Package and Product Measurement Standard](#) to ensure consistency.

Following are the recommended steps for performing measurements:

- Consumer Trade Items
 - Identify the default front of the sample. Place the sample on a smooth, flat surface so that the default front is facing you.
 - Utilising the proper tool, measure the width of the trade item and record the results.
 - Repeat the measurement for the trade item depth and height and record the results.
 - Repeat steps 1 thru 3 on the stack of items

- Non-consumer Trade Items

Not normally associated with nesting, these product types can also use the same procedure for the determination of nesting value as indicated in section 3.1.1.

14.3.5.6 Recording the Data

It is important that the data collected be applied to the dimensions of the product based on the [GS1 Package and Product Measurement Standard](#) designation of front.

With this in mind here is an example of how the data should be recorded where the nesting value would be applied to a face other than the default front.

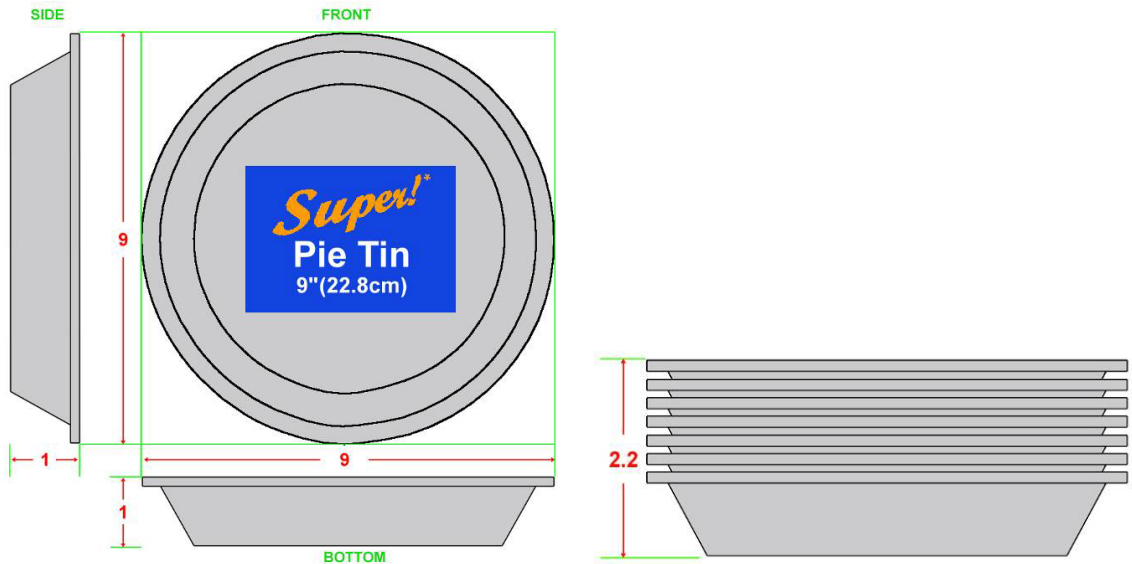

$$N = \frac{A-B}{Tc-1} \quad \blacksquare \quad N = \frac{2.2-1}{7-1} \quad \blacksquare \quad N = \frac{1.2}{6} \quad \blacksquare \quad N = 0.2$$

Product Dimensions			Nesting Dimensions			Type	Direction
Height	Width	Depth	Height	Width	Depth	Pos/Neg	Vert/Horiz
9	9	1	0	0	0.2	Positive	Vertical

The product dimensions are based on the default front determined using the [GS1 Package and Product Measurement Standard](#). With this in mind, the dimension affected by nesting would be the depth, and type of nesting is positive. The direction in this example is vertical.

14.3.6 Inner Packs

This section covers the requirements arising from the need for accurate dimensions for unmarked inners by space management systems. Because of the increased occurrence of unmarked shelf ready packaging the community identified a need to communicate dimension information for unmarked inners for shelf planning.

Some non-consumer trade items are offered in shelf-ready packaging which is intended for display at the point-of-sale. "Open Top Display", "Tear-Away Display Box" or "Tray-packs" are examples of such packaging. Many of these packaging levels are unmarked – without barcode printed on them. In most cases shelf ready packaging is trade item (logistical unit) with its own GTIN, but there are some groupings of base units used for better handling without assigned GTIN.

14.3.6.1 Marked Inners

These products are regular groupings of consumer units with their own barcode and GTIN and same rules would apply as for base consumer units. Because they are consumer units they would be measured according to standard front of the product.



14.3.6.2 Unmarked Inners

These products are regular groupings of consumer units not intended for purchase, without barcode printed. Example would be tray of instant soups that sits on the shelf. It doesn't have its own GTIN or barcode, but holds individual pouches, envelopes in place.



To be able to communicate dimensions for unmarked inners they have to have GTIN assigned to them. These GTINs could be virtual or physically marked on the packaging. Assignment of GTINs virtually does not force manufacturers to change the packaging, only assign GTIN to the product level.

This will help improve the availability of dimensions for unmarked inner packs and accuracy of the information received by retailers. Assigning or marking GTINs to all packaging levels of the hierarchy including unmarked inners allows alignment of dimensions for all levels.

14.3.7 Split Cases

Split case is the special case where case is split into two units which are used for display. This case is different than case with two or more inner packs which are display units (shelf ready). Because individual display units did not exist inside the case we cannot handle them as inners.

From all examples available to us by splitting the case we produced two equal display units. These units could be displayed side by side or one behind the other or just one of them. For this reason it is impossible to get dimension of the total "display unit", but we can measure and communicate the dimensions of one unit.





15 Extended Attributes

The GS1 GSMP now offers a variety of attribute solutions for conducting global data synchronisation within the GDSN. This provides users with the flexibility they need to build out their implementations using Standard Attributes, Global Data Dictionary Fast Track Attributes and Extended Attributes – non-standard attributes transported within the GDSN in a standard way. The types of attributes used within GDSN impacts where they are housed in GS1 standards and what type of functionality they have.

- **Important:** An Extended Attribute is not to be confused with an Extension. An Extension (e.g. the Hardlines Extension) is a part of the GS1 standards where attributes relevant for a specific sector or function have been grouped together.

Extended Attributes are non-standard attributes that are not found in the [GS1 Navigator](#), [GDSN](#) and are not part of the message standard but can be sent with the standard data over the GDS Network. For fuller definitions, see Section [15.6](#).

15.1 Pre-Requisites

- Trading partners wish to implement GDSN but not all data requirements are covered by existing GS1 GDSN standards.
- Trading partners reach agreement on exchanging non-standard information to supplement the standard information.

- Standard GDSN choreography is still used.

15.2 When Would I Use This?

- **Important:** Extended Attributes should be avoided whenever possible! Standard attributes should always be used if possible, and participants are recommended to refer to their Data Pool and their local GS1 Member Organisation for help in identifying the correct standard attributes.

However there are two occasions when it is not possible to use standard attributes:

- The data recipient has a new business requirement not yet covered by existing GS1 standards.
- During transition into GDSN, the data recipient or the data source is not able to receive or send some data using the normal standard attributes, perhaps because of temporary constraints in existing internal systems.

Until either (1) the business requirement is approved for inclusion in GS1 standards, or (2) the temporary system constraints are overcome, it is possible to deploy Extended Attributes in the GDSN Network to communicate non-standard data.

- **Note:** Because they are extended attributes, you have a risk that your Trading partner might not be able to support these attributes since they are not standard.

15.3 Guiding Principles for Extended Attributes

The guiding principles underlying the data management process are:

- Non-Standard Extended Attributes can be transported in-Network
- Attribute characteristics are defined and published for all attribute types. The current process for defining attribute characteristics of full standards will be followed for Fast Track attributes and non-standard Extended Attributes
- **Note:** Providing a full definition including data formats ensures that well-formed definitions are available for Data Sources and will minimise any misunderstanding or ambiguity.
- Once Extended Attributes have been fully defined, they can be used immediately in-Network. This is contingent on Data Pool capability to communicate Extended Attributes via GS1 Attribute/Value Pairs (A/VP)
- Extended Attributes must only be transported in-Network following the technical specifications of the GS1 A/VP schema
- Schema validation and validation rules are not supported for Fast Track and Extended Attributes

15.4 Features of Extended Attributes

- Extended Attributes are non-standard attributes which have gone through the Data Management harmonisation process and are approved for transport in the network. See [GDSN Extended Attributes](#).
- Extended Attributes are exclusively transported as Attribute Value Pairs.
- Extended Attributes may be used in the network immediately.
- Extended Attributes used in the network are posted on the GS1 site. See [GDSN Extended Attributes](#).
- There are no schema validations of Extended Attributes.
- Extended Attributes use XML instance files generated by the user.

15.5 How to create or remove Extended Attributes

The following section describes how to create and remove extended attributes.

15.5.1 Process for Creation of Extended Attributes

The major steps are as follows:

1. The Data Recipient communicates the request for additional non-standard data to his Data Pool or local GS1 MO.
2. Together they research the GS1 standards in case an existing attribute can be identified which will meet their needs.
 - **Note:** Given the nature of Extended Attributes, GS1 MOs will make every effort to harmonise Extended Attributes to uphold GS1 standards. Commercial GDSN certified Data Pools are under no obligation to do so, but can offer this service as a value added service.
3. If the DP/MO determination is that an attribute is not available in published GS1 standards, the DP/MO contacts GS1 to request access to the Extended Attribute tool on behalf of the Recipient.
4. The DP/MO uses the tool to load attributes and a Recipient profile.
 - **Note:** The tool prompts the DP/MO for the required information. If any of the required fields are missing, the spreadsheet will not be accepted by the tool. Additionally, duplicate attribute names are identified and eliminated.
5. A GS1 representative checks the attribute names to ensure naming rules have been followed and that all required information fields has been entered.
6. The Extended Attributes are immediately available for exchange in-Network when all the required information has been captured in the Extended Attributes Web Tool.

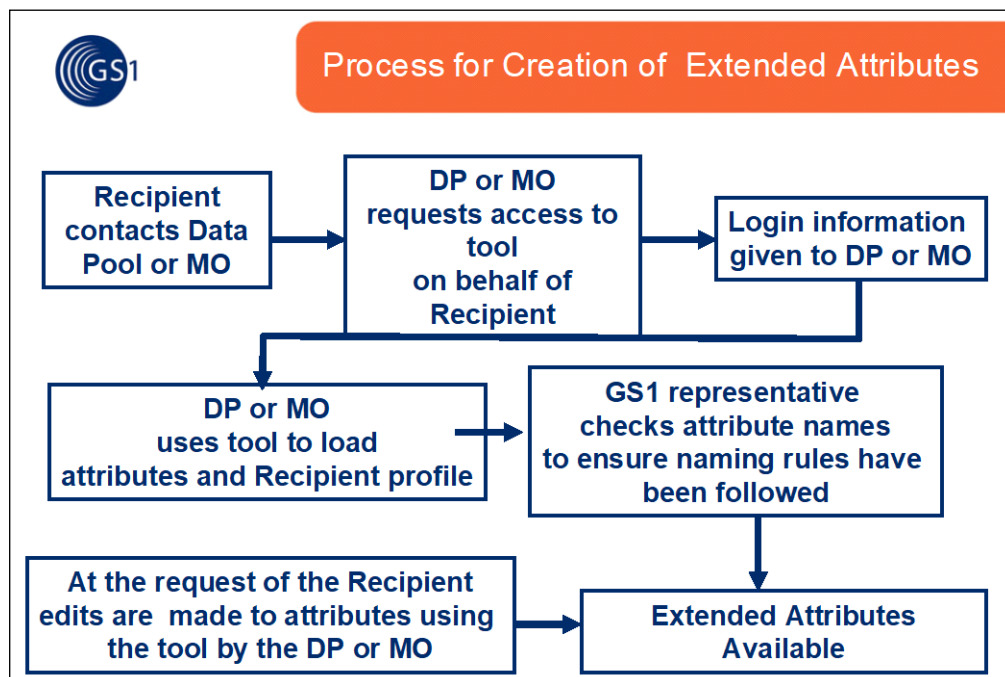

15.5.2 Processes for the Removal of Extended Attributes

Two processes have been established for the review and removal of Extended Attributes when they no longer serve their original purpose or when better alternatives are available. These processes are the following:

- Attribute Harmonisation Leads to Work Request Submission Process
- New GDSN Release Leads to Migration from Extended Attributes.

It is recognised that there could be many triggers for harmonisation with the GS1 Navigator, GDSN or removal from the Extended Attribute list, for example:

- A Sender or data pool recognises they are sending the same attribute value to multiple Recipients using different GDSN Extended Attributes
- The user community determines that a formal GSMP Change Request contains attributes currently being communicated as Extended Attributes

15.5.3 Attribute Harmonisation Leads to Work Request Submission Process

Typically, this process is triggered by the Data Source. It may also be initiated by a Certified Data Pool or GS1 MO. The Data Source has been inputting Extended Attributes for several Recipients and has identified common attributes. These common attributes would better serve the industry if they were normalised into one attribute term with one definition and one set of characteristics.

The major steps are as follows:

1. The Sender contacts their DP/MO.
 2. The DP/MO analyses the attributes or group of attributes and agrees that normalisation is the proper course.
 3. The Sender's DP/MO contacts other DP/MOs acting on behalf of the Recipients and Senders impacted by these attributes.
 4. The DP/MOs jointly discuss the attributes and evaluate the needs of the trading partners. They decide to enter a GSMP Change Request for the business requirements which until were sent as Extended Attributes.
 5. The GDS Standards Maintenance Group (SMG) processes the Work Request according to GSMP due process.
 6. Once the Standard Attributes are available, the Extended Attributes are removed from the GS1 site by the DP/MO using the web tool and observing whatever transition plan has been developed. This may be accelerated by using Fast Track attributes, until the approved business requirement for the new attributes becomes a part of the GS1 Business Message Standard (normally at the next available network Maintenance Release).
- **Note:** This process can also be triggered if a GDSN Participant raises a request to harmonise Extended Attributes with standard attributes that already exist.

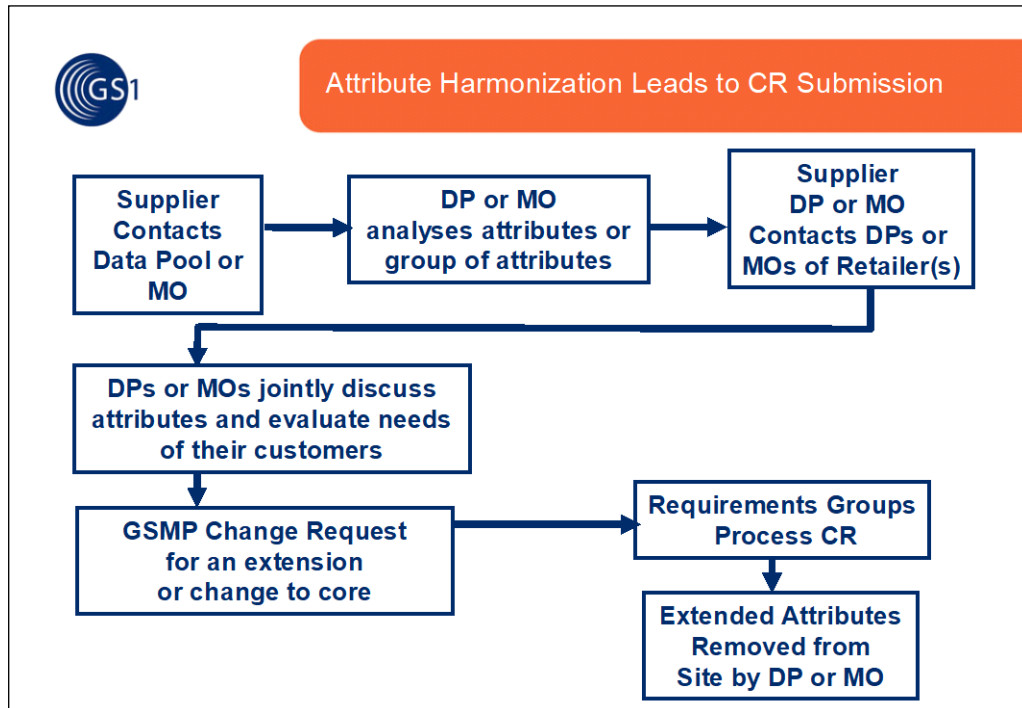

15.5.4 New GDSN Release Leads to Redundant Extended Attributes

This process is triggered by the introduction of a new GDSN Release.

The major steps are as follows:

1. A new GDSN Release (when a new version of the Trade Item Business Message Standard is deployed into the production GDS Network) triggers a review of existing Extended Attributes.
2. Any GDSN Participant, or the GS1 GSMP GMD SMG with the GDSN User Group, identifies the redundant Extended Attributes for removal. The attributes are redundant because they have since been replaced by standard attributes, now deployed into the Network in the new GDSN Release.
3. The Data Recipient (who had originally requested the Extended Attributes) announces the intention to migrate to using the standard attributes, and works with their (Recipient) Data Pool, the relevant Data Sources and their (Source) Data Pools to plan the transition and make the change.
4. The Extended Attributes are removed from the GS1 site by the DP/MO using the web tool.

15.6 Your Questions Answered

The following section presents some frequently asked questions regarding extended attributes.

15.6.1 Are Extended Attributes the attributes in an Extension?

No, these are two different concepts.

Extended Attributes are non-standard additions to the standard messages, and facilitate implementation when a Data Recipient has some non-standard requirements which have (not yet) been submitted to and approved through GSMP.

A GDSN Extension is a full part of the GS1 GDSN standards. It is known as an “extension” to show that it is not a part of the “core” message. The “core” is always sent; extensions are sent as appropriate. For example, the Regulatory Extension is only sent when the Data Source needs to communicate additional information about the regulations and regulatory approvals relevant to the Trade Item.

15.6.2 Are Extended Attributes part of the GS1 standards?

No, Extended Attributes are not part of the GS1 standards.

To aid visibility of specific non-standard requirements, GS1 has established a mechanism to publish Extended Attributes on the website of the GS1 Global Data Dictionary. But it does not include them within standards, nor does it endorse them in any way.

15.6.3 Are Extended Attributes the same as “AVP Attributes”?

No, these terms are not synonyms.

Extended Attributes refers to the definition of some non-standard data requirements.

AVP refers to a transport mechanism within GS1 XML Business Messages. It allows the data attribute Name and its Value to be sent together, without needing the data attribute Name to be defined in advance and “hard-coded” into the XML schema.

Some GS1 standard attributes and all extended Attributes use the AVP transport mechanism to send data via GDSN standard messages.

15.6.4 What if my customer demands some non-standard data? Can I send it to him through the GDS Network?

GS1 always encourages trading partners to use standard definitions whenever possible.

If the GS1 standards do not cover all the customer’s requirements, the customer may be able to use Extended Attributes to send the information. As a first step the customer should approach his GS1 Member Organisation or GDSN Data Pool.

If the customer really cannot find support for their business requirements within the GS1 standards, they may apply to have the non-standard requirements listed as Extended Attributes. Before they will be accepted as Extended Attributes, the customer’s local GS1 Member Organisation or the customer’s data pool must review the business requirements. They may be able to identify a way of using existing GS1 standards to meet the business requirements, or advise the customer to submit a GSMP Change Request to add the business requirements to the GS1 GDSN standards. Only if neither of these are possible will the request to list the requirements as Extended Attributes go forward to GS1.

15.6.5 What if my supplier cannot meet all my data needs through the GS1 GDSN Standards?

It depends on the reason why your supplier cannot meet your data needs.

Are all your requirements met by data attributes defined in the GS1 standards? Normally the supplier can only send data for which GS1 GDSN Standards have been defined.

If you have requirements which are not supported by the GS1 standards, discuss your requirements with your GS1 Member Organisation or GDSN Data Pool. They may be able to suggest how your requirements can be met within existing standards, or help you submit a Change Request to add your business requirements to the Standards. If, however, you urgently need non-standard data, your GS1 Member Organisation or GDSN Data Pool can assist you in requesting for your requirements to be listed as Extended Attributes.

Once the requirements are published as Extended Attributes, you can refer your supplier to the Extended Attribute definitions on the website of the GS1 Global Data Dictionary.

15.6.6 Can you explain the terminology? What “types” of attributes are supported?

GS1 GSMP offers 3 categories of attributes providing users with the flexibility to build out their GDSN implementation more quickly. The table below explains these categories.

- **Note:** The ability to allow a user to migrate towards the standard and to use non-standard attributes in-Network was new to GSMP in 2006. Management of these capabilities will continue to evolve.

Table 15-1 Terms Currently Used to Describe GDSN Attribute Types

Current Term	Current Term Definition
1. Standards	Attributes that have been approved through the GSMP due process and are entered into the GS1 Navigator, GDSN.
2. Fast Track (FT)	<p>When the business requirement for a new attribute is approved through the GSMP due process, the requester of the new attribute may request a quick interim implementation solution, known as a Fast Track (FT) solution. The GSMP modellers review the approved business requirements and assess if they should be allowed in-Network.</p> <p>FT use the Attribute / Value Pairs (A/VP) as the transport mechanism. A/VPs use one generic schema template that does not change with the introduction of new attributes, thus expediting their immediate introduction into the network. The disadvantage of this method is that attributes are not validated by the schema parser nor can relationships be established between the independent attributes.</p> <p>In any case, the approved business requirement for a new attribute will in due course become a part of the GS1 Business Message Standard (normally at the next available network Maintenance Release). When this permanent solution is implemented in-Network, any associated FT attributes will be removed from the A/VP communication (these will be sun-set over time)</p> <p>The FT is an interim solution of the GS1 GSMP attribute approval process and the A/VP is the method of transport.</p>
3. Extended Attributes	Extended Attributes are non-standard attributes that are not found in the or in the Fast Track and are not part of the message standard. They are however transported in a standard manner using A/VP transport mechanism that is also used for FT Attributes.

Historically, different terminology has been used, but these three terms are the only ones currently accepted.

15.7 Extended Attributes References

For more information on Extended Attributes and their role and management in GDSN, please refer to:

- [Extended Attributes](#)
- BMS and BRAD for Use of Attribute Value Pairs to Transmit Non-Standard Attributes in GDSN <https://www.gs1.org/access-gdsn-standards>

16 Variable Measure for Net Content

A trade item may contain a variable net content for one measure (e.g. count varies between 12 and 18 pieces) but be fixed for another measure (e.g. weight is always 11 kilograms).

When this happens, the recommendation is to populate net content with both measures (using an average value for the variable measure) and to ensure that the **isTradeItemAVariableUnit** flag is marked as TRUE. This will satisfy the system need for information. All of the trade item’s description fields (such as **descriptionShort**, **TradeItemDescription**, **invoiceName**, and **AdditionalTradeItemDescription**) may include the terms used by the supplier to describe the range for that variable measure.

- **Note:** Where the variable measure is a weight, the Gross and Net Weight values should be the average weight.
- **Note:** This best practice should be followed for any GTIN (any level of the item hierarchy) where there is a variable measure concern.

- **Note:** Net Content is normally only populated at the consumer unit level. When applying the following examples to a non-consumer unit, the net content values may not be populated. If net content is not populated the guidance around the other attributes should be followed.
- **Note:** While it is not specifically noted in the examples below, should the GTIN have a variable count and also have a child GTIN, then the average count should also be used in the **quantityOfNextLowerGTIN**.

16.1 Variable for One Measure

16.1.1 Example 1

A trade item which is a case of chicken which has a consistent weight, but variable count of 12 to 18 pieces would have the following information populated:

netContent: 15 PCS; 11 Kg

netWeight: 11 Kg

isTradeItemAVariableUnit: TRUE

grossWeight: 11.2 Kg

Description Fields: "...12-18 Count..."

Figure 16-1 Variable in Count



16.1.2 Example 2

A trade item which is a case of cheese which has a consistent count, but variable weight of 10 to 12 Kilograms would have the following information populated:

netContent: 11 Kg; 6 Ea

netWeight: 11 kg

isTradeItemAVariableUnit: TRUE

grossWeight: 11.2 Kg

Description Fields: "...10-12 Kilo..."

Figure 16-2 Variable in Weight



16.2 Variable for more than one measure

16.2.1 Example 1

A trade item which is a case of chicken with a variable weight of 10 to 12 kilograms and count of 12 to 18 pieces would have the following information populated:

netContent: 15 PCS; 11 Kg

netWeight: 11 Kg

grossWeight: 11.2 Kg

isTradeItemAVariableUnit: TRUE

Description Fields: "...12-18 Count..." AND "...10-12 Kilos..."

Figure 16-3 Variable in Both Measures



17 Promotional Item Information Module

The Promotional Item Information Module allows promotional item information that is related to a specific trade item to be passed in the network. This enables retailers to properly merchandise Promotional Trade Items and to calculate the impact and benefits of the promotional offer.

The objective of this guide is to explain how to effectively use the Promotional Item Information Module.

17.1 Terms used in this Section

Some terms used in this section are as follows:

- **Each:** In this section, identify a consumer unit which is not a pack (nor a case for cash and carry distribution channel). The trade item is declared as the base unit of its logistical hierarchy (**isTradeItemABaseUnit=TRUE**).

- **Multipack:** Identify a consumer unit composed of two or more **Eaches** that are also sold separately, that have been bound together in a new trade item. The **Eaches** are all the same (homogeneous).
- **Assortment Pack:** Identify a consumer unit composed of two or more **Eaches** that are also sold separately, that have been bound together in a new trade item. The **Eaches** are not the same (heterogeneous).
- **Standard Trade Item:** The Standard Trade Item is a trade item that serves as a base for the promotion. It is a trade item that is generally offered for sale by the manufacturer on an on-going basis. The Standard Trade Item is the one being used to calculate the price reduction or discount of the Promotional Trade Item. It is also the one being used to prove the legitimacy/validity of the promotion in regards to the legal regulations.
- The Standard Trade Item must be traded and published prior to the setup of a Promotional Trade Item.
- **Promotional Trade Item:** A Trade Item that has been modified from its normal structure to include a promotional offering that is physically affixed to the trade item. These promotional offerings maybe include free quantities, a free gift with the attachment of another trade item, or some other type of special packaging. Promotional Trade Items can be established as Promotional Multipacks, Promotional Assortment Packs or Promotional **Eaches**
- **Promotional Multipack and Promotional Assortment Pack:** A multipack or assortment pack that has been designed to reflect a promotional offer. Promotional Multipacks and Promotional Assortment Packs may or may not be associated with Standard Trade Items at the Pack level (Standard Multipack or Standard Assortment Pack). If a Promotional Pack/Promotional Assortment Pack is not associated with a Standard Trade Item at the Pack level, it will be associated with a Standard Trade Item at the **Each** level (Standard Each).
- **Promotional Each:** An **Each** that has been designed to reflect a promotional offer. A Promotional **Each** is always associated with a Standard Trade Item at the **Each** level. If a Promotional **Each** is offered for sale, it generally replaces the sale of the Standard Trade Item of a period of time.
- **Component:** Identifies an **Each** from which the Multipack or Assortment Pack is derived. A component of Promotional Multipack or Promotional Assortment Pack can be Promotional **Eaches** or non-promotional **Eaches**.

17.2 Pre-Requisites

- The supplier has previously offered a “standard” form of the product and now wishes to offer a “promotional” form of the product.
- A new GTIN has been allocated to identify the promotional form of the product. The “promotional” form and the “standard” form of the product are not identified by the same GTIN.
- The supplier can publish information on his products via GDSN to his customer(s).
- The supplier can prove the actual benefits of the promotion for the customers. The way the supplier has to prove these benefits depends on local regulations.
- Both parties are capable of exchanging information using the Promotional Item Information Module.
- **Note:** Legal regulations regarding promotional claims vary in different regions; therefore it is advised to take great care in validating that promotional claims are made compliant to all local regulations. The examples set on this document are therefore guidelines of particular scenarios that may not apply to all countries in the same way.
- **Note:** This guideline describes only promotions for which a new GTIN has to be allocated to identify the Promotional Trade Item. It is based on the [GS1 GTIN Management Standard](#) which specifies which kinds of promotions induce the allocation of a new GTIN.

17.3 When Would I Use This?

The Promotional Item Information Module would be used to communicate Promotional Trade Item offers such as:

- Free quantities
- Free samples
- Free gifts
- Unique packaging

The use of this module communicates information on these Promotional Trade Items and also establishes the link to the Standard Trade Items they temporarily replace or complement.

17.4 General Rule

- The Promotional Item Information Module should be coded at the hierarchy level (Trade Item Unit Descriptor Level) that contains the promotional product that will be offered to a consumer. This will be the Pack / Innerpack (Multipack), or the **Each** level.
- As a promotion is a time limited event, **startAvailabilityDateTime** and **endAvailabilityDateTime** must be indicated at the hierarchy level that contains the promotional product.
- This guide focuses on how effectively use the Promotional Item Information Module. However other attributes of the Trade Item must be used to describe the promotional offer. These attributes should be populated when describing a Promotional Trade Item.
 - **offerOnPack**: Describe the promotional offer as claimed for the consumer on the Promotional Trade Item's packaging.
 - Descriptive fields such as **descriptionShort**, **tradeItemDescription** should identify the product as a promotional product. They should also give some information on the promotional offering.
 - **Trade ItemPriceTypeCode**: Indicates the retail price as marked on the trade item package. It is an optional attribute, used if the retail price is on the trade item package.

17.5 How to Populate the Promotional Item Information Module

The Promotional Item Information describes promotional activity or claims that are physically declared on consumer trade items. The following section provides definitions for the attributes composing this module:

- **freeQuantityOfNextLowerLevelTradeItem**: The amount of free quantity contained in one component of a Promotional Assortment Pack. This quantity must be expressed by the same unit of measure as the net content of the component. If multiple net content expressions exist, the unit of measure used is consistent with the one used to display prices (if the latter is defined).
- **freeQuantityOfProduct**: The amount of free quantity contained in the offered Promotional **Each** or Promotional Multipack. This quantity must be expressed by the same unit of measure as the net content of the Promotional **Each** or Promotional Multipack. If multiple net content expressions exist, the unit of measure used is consistent with the one used to display prices (if the latter is defined).
- **nonPromotionalTradeItem**: GTIN for the Standard Trade Item. Used to identify the Standard Trade Item that is replaced by or coexists with the Promotional Trade Item offered.
- **promotionTypeCode**: Type of promotion. Used to identify the different types of free quantity promotional trade items and the nature of the link between the standard trade item and the promotional trade item

The GDSN code list definitions for **PromotionTypeCode** can be found in the [GS1Navigator, GDSN](#).

- **Note:** The definitions for the promotional types have some overlap. It is understood that the examples in section [17.6](#) are one reasonable interpretation of the differences between the codes.

17.6 Examples of Promotional Trade Items

Use of the Promotional Item Information Module depends on the type of promotion being offered. The user must follow the steps outlined for each specific scenario to properly identify the correct attributes and code names that correspond to each scenario.

These different steps generally consist of:

- Identifying the type of Promotional Trade Item (Each, Multipack or Assortment).
- Identifying the Standard Trade Item GTIN Specifying the free quantity and its unit of measure, relative to the Standard Trade Item.
- Identifying the type of promotion from the code names and definitions in the Promotional Type Code List.

17.6.1 Free Quantity

The examples that follow are all categories of promotion which offer a free quantity with the item. The amount of free quantity is displayed on the packaging.

17.6.1.1 Promotional Each with a Free Quantity

The Promotional **Each** offers a free quantity. It is neither a Multipack nor an Assortment Pack. This type of promotion requires a change in GTIN; the Promotional Trade Item and the Standard Trade Item do not share the same GTIN. The Standard Trade Item is always a Standard **Each**.

17.6.1.1.1 1st Scenario – Promotion Each with Free Components

The Promotional Each shares the same format, net content and characteristics as the Standard Each.

When the promotion contains free included components or material, the Promotional Item Information uses, at the BASE_UNIT_OR_EACH level, the following attributes:

- **nonPromotionalTradeItem:** GTIN for the Standard **Each** that shares the same format, content and characteristics as the Promotional **Each**.
- **promotionTypeCode:** FREE_COMPONENTS for the free included components or materials.
- **freeQuantityOfProduct:** Free quantity contained in the offered Promotional **Each**.

Example:



The Standard **Each** and the Promotional **Each** have the same net content = 250 g. The Promotional **Each** includes 10% free, so that the retail price is reduced even though if the actual net content stays the same. They share the same characteristics and format. The type of promotion is therefore a free component.

At the **BASE_UNIT_OR_EACH** level, the Promotional Item Information Modules used as follows:

- freeQuantityOfProduct = 25 g
- nonPromotionalTradeItem = GTIN for the Standard Each
- promotionTypeCode = FREE_COMPONENTS

17.6.1.1.2 2nd Scenario – Promotional Each with Free Quantity

The Promotional Each declares an additional free quantity over the Standard Each.

The Promotional **Each** has a net content greater than the Standard **Each**. The difference between those two net contents corresponds to the free quantity. The two **Eaches** have the same characteristics, format and are sold at the same price.

When the promotion is linked to a “bonus” quantity, the Promotional Item Information Module uses, at the **BASE_UNIT_OR_EACH** level, the following attributes:

- **nonPromotionalTradeItem:** GTIN for the Standard **Each** that shares the same format and characteristics as the Promotional **Each** that offers more free quantity.
- **promotionTypeCode:** BONUS_PACK for free additional quantities offered.
- **freeQuantityOfProduct:** Free quantity contained in the offered Promotional **Each**.

Example: (would be beneficial to include the picture of the Standard Trade Item as well as the Promotional Trade Item)



Standard **Each** contains 150 g and shares the same format and characteristics as the Promotional **Each** that offers more free quantity. The net content of the Promotional **Each** is 180 g. The Promotional **Each** is sold at the same price as the Standard **Each**.

At the **BASE_UNIT_OR_EACH** level, the Promotional Item Information Module is used as follows:

- freeQuantityOfProduct = 30 gr
- nonPromotionalTradeItem = GTIN for the Standard Each
- promotionTypeCode = BONUS_PACK

17.6.1.2 Multipack with a Free Quantity

This Promotional Trade Item is a Multipack that offers a free quantity. This type of promotion requires a change in GTIN or a new GTIN; the Promotional Multipack and the Standard Trade Item do not share the same GTIN. The Standard Trade Item can be a Standard Multipack or a Standard **Each**.

17.6.1.2.1 1st Scenario – Multipack with Free Components

The Promotional Multipack shares the same format, net content and characteristics as the Standard Multipack.

In the case where the promotion contains free included components or materials, the Promotional Item Information Module, at the **PACK_OR_INNER_PACK** level, uses the following attributes:

- **nonPromotionalTradeItem:** GTIN for the Standard Multipack that shares the same format and characteristics as the Promotional Multipack.
- **promotionTypeCode:** FREE_COMPONENTS
- **freeQuantityOfProduct:** Free quantity contained in the offered Promotional Multipack.

Example:



The existing Standard Multipack of six 1.5 litre bottles shares the same format and characteristics as the Promotional Multipack. The Standard Multipack and the Promotional Multipack have the same net content 9 lt. The difference is that for the Promotional Multipack, the consumer is charged for only five bottles but receives six bottles.

At the PACK_OR_INNER_PACK level, the Promotional Item Information is used as follows:

- **freeQuantityOfProduct** = 1,5 lt
- **nonPromotionalTradeItem** = GTIN for the Standard Multipack
- **promotionTypeCode** = FREE_COMPONENTS

17.6.1.2.2 2nd Scenario – Multipack with Free Quantity

The Promotional Multipack declares an additional free quantity over the Standard Multipack.

The Promotional Multipack has a net content greater than the Standard Multipack. The difference between those two net contents corresponds to the free quantity. The two Multipacks have the same characteristics, and are sold at the same price.

When the promotion is linked to a “bonus offer”, the Promotional Item Information Module uses the following attributes:

- **nonPromotionalTradeItem:** GTIN for the Standard Multipack that shares the same format and characteristics as the Promotional Multipack that offers more free quantity.
- **promotionTypeCode:** BONUS_PACK
- **freeQuantityOfProduct:** Free quantity contained in the offered Promotional Multipack.

Example:



The Promotional Multipack has a net content greater than the Standard Multipack. The Standard Multipack contains 15 cans whereas the Promotional Multipack contains 18 cans, where the three extra cans are free. The Promotional Multipack and the Standard Multipack are sold at the same price.

At the **PACK_OR_INNER_PACK** level, the Promotional Item Information Module is used as follows:

- **freeQuantityOfProduct** = 99 cl
- **nonPromotionalTradeItem** = GTIN for the Standard Multipack
- **promotionTypeCode** = BONUS_PACK

17.6.1.2.3 3rd Scenario – Promotional Multipack built from a Non Promotional Each

Standard Multipack does not exist. The Each contained within the Multipack is not promotional.

The promotion offers a Promotional Multipack created exclusively for an event. This Multipack contains an **Each** that is not promotional. At the **PACK_OR_INNER_PACK** level, the Promotional Item Information Module uses the following attributes:

- **nonPromotionalTradeItem:** GTIN for the Standard **Each** contained within the Promotional Multipack.
- **promotionTypeCode:** MULTI_PACK_AND_COMBINATION_PACK
- **freeQuantityOfProduct:** Free quantity contained in the offered Promotional Multipack.

Example:



This is a multipack that contains 3 **Eaches**, 1 is free. The consumer pays twice the normal price of the **Each**. Standard Multipacks that share the same format as the Promotional Multipacks do not exist (Standard Multipack of two **Each** or Standard Multipack of three **Eaches** do not exist). As the promotional module must refer to a commercialised non Promotional Trade Item, the only possibility is to refer to the Standard Each contained within the promotional Multipack.

At the **PACK_OR_INNER_PACK** level, the Promotional Item Information Module is used as follows:

- **freeQuantityOfProduct** = net content of 1 **Each** (expressed in the same unit of measure).
- **nonPromotionalTradeItem** = GTIN for the Standard **Each** contained within the Promotional Multipack
- **promotionTypeCode** = MULTI_PACK_AND_COMBINATION_PACK

17.6.1.2.4 4th Scenario – Promotional Multipack built from a Promotional Each

A Standard Multipack does not exist. The Each contained within the Promotional Multipack is promotional.

The promotion offers a Promotional Multipack created exclusively for an event. This Multipack contains an **Each** that is promotional. The Promotional Item Information Module is used both at the **PACK_OR_INNER_PACK** level and at the **BASE_UNIT_OR_EACH** level.

At the **PACK_OR_INNER_PACK** level, the Promotional Item Information Module uses the following attributes:

- **nonPromotionalTradeItem:** GTIN for the Standard **Each** to which refers the Promotional **Each** contained within the Promotional Multipack.
- **promotionTypeCode:** MULTI_PACK_AND_COMBINATION_PACK
- **freeQuantityOfProduct:** Free quantity contained in the offered Promotional Multipack.

At the **BASE_UNIT_OR_EACH** level, the Promotional Item Information Module uses the following attributes:

- **nonPromotionalTradeItem:** GTIN for the Standard **Each**
- **promotionTypeCode:** BONUS_PACK for free additional quantities offered (example below) or FREE_COMPONENTS for free included components or materials
- **freeQuantityOfProduct:** Free quantity contained in the offered Promotional **Each**.

Example:



Standard Multipacks that share the same format as the Promotional Multipacks do not exist (Standard Multipacks of two 400 ml **Eaches** or Standard Multipacks of two 300 ml **Eaches** do not exist). As the promotional module must refer to a commercialised non Promotional Trade Item, the only possibility is to refer to the Standard **Each** that contains 300 ml (GTIN1). The **Each** (that contains 400 ml, GTIN2) composing the Promotional Multipack (GTIN3) is itself promotional.

At the **PACK_OR_INNER_PACK** level (GTIN3), the Promotional Item Information Module is used as follows:

- **freeQuantityOfProduct** = 200 ml
- **nonPromotionalTradeItem** = GTIN for the Standard **Each** (300 ml) = GTIN1
- **promotionTypeCode** = MULTI_PACK_AND_COMBINATION_PACK

At the **BASE_UNIT_OR_EACH** level (GTIN2), the Promotional Item Information Module is used as follows:

- **freeQuantityOfProduct** = 100 ml
- **nonPromotionalTradeItem** = GTIN for the Standard **Each** (300 ml) = GTIN1
- **promotionTypeCode** = BONUS_PACK

17.6.1.3 Free Quantity on One or More Components of an Assortment Pack

This type of promotion is an Assortment Pack that offers a free quantity on one or more different components. This type of promotion requires a new GTIN; the Promotional Trade Item and the Standard Trade Item do not share the same GTIN.

In an Assortment Pack scenario, the free quantity description is linked to the **Eaches** that make up the contents of the pack. The Standard Trade Item is always a Standard **Each**. The Promotional

Item Information Module is applied to each **Each** contained in the Assortment Pack that contains a free quantity offered in the promotion.

17.6.1.3.1 1st Scenario – Assortment Pack built from Non Promotional Eaches

A Standard Assortment Pack does not exist. The Eaches contained within the Assortment Pack are not promotional.

The promotion offers a Promotional Assortment Pack created exclusively for an event. This Assortment Pack contains **Eaches** that are not promotional.

At the **PACK_OR_INNER_PACK** level, the Promotional Item Information Module is applied to each **Each** contained in the Assortment Pack and uses the following attributes:

- **nonPromotionalTradeItem:** GTIN for one of the Standard **Eaches** included in the Promotional Assortment Pack that contains the free quantity offered.
- **promotionTypeCode:** MULTI_PACK_AND_COMBINATION_PACK
- **freeQuantityOfNextLowerLevelTradeItem:** Free quantity contained in the Standard **Each** included in the Promotional Assortment Pack.

Example 1



Standard Assortment Packs that share the same format as the Promotional Assortment Packs do not exist. As the promotional module must refer to commercialised non Promotional Trade Items, the only possibility is to refer to the Standard **Each** that contains 400 ml (GTIN 1) and to the Standard **Each** that contains 150 ml (GTIN 2). The promotion is divided up between the package's contents. The Assortment Pack is promoting two atomisers, one 400 ml, and one 150 ml, whereby 50ml of the combined atomiser content is free.

The Promotional Item Information Module is repeated twice:

1st repetition:

- **freeQuantityOfNextLowerLevelTradeItem** = 36,36 ml $\langle (400 / (400 + 150)) * 50 \rangle$
- **nonPromotionalTradeItem** = GTIN 1
- **promotionTypeCode** = MULTI_PACK_AND_COMBINATION_PACK

2nd repetition:

- **freeQuantityOfNextLowerLevelTradeItem** = 13,64 ml $\langle (150 / (400 + 150)) * 50 \rangle$
- **nonPromotionalTradeItem** = GTIN 2
- **promotionTypeCode** = MULTI_PACK_AND_COMBINATION_PACK

- **Note:** The only way to describe this scenario is to repeat the information within the Promotional Item Information Class.

17.6.1.3.2 2nd Scenario – Promotional Assortment Pack built from Promotional Eaches

A Standard Assortment Pack does not exist. The Eaches contained within the Assortment Pack are promotional.

The promotion offers a Promotional Assortment Pack created exclusively for an event. This Assortment Pack contains **Eaches** that are themselves promotional. The Promotional Item Information Module is used both at the **PACK_OR_INNER_PACK** level and at the **BASE_UNIT_OR_EACH** level.

At the **PACK_OR_INNER_PACK** level, the Promotional Item Information Module is applied to each Promotional **Each** contained in the Assortment Pack and uses the following attributes:

- **nonPromotionalTradeItem:** GTIN for the Standard **Each** to which refers the Promotional **Each** contained within the Assortment Pack.
- **promotionTypeCode:** **MULTI_PACK_AND_COMBINATION_PACK** to offer a promotional pack.
- **freeQuantityOfNextLowerLevelTradeItem:** Free quantity contained in the Promotional **Each** included in the Promotional Assortment Pack.

At the **BASE_UNIT_OR_EACH** level, the Promotional Item Information Module is applied to each **Each** contained in the Assortment Pack and uses the following attributes:

- **nonPromotionalTradeItem:** GTIN for the Standard **Each**
- **promotionTypeCode:** **BONUS_PACK** for free additional quantities offered (example 1 below) or **FREE_COMPONENTS** for free included components or materials (example 2 below)
- **freeQuantityOfProduct:** Free quantity contained in the offered Promotional **Each**.

Example 1



Standard Assortment Packs that share the same format as the Promotional Assortment Packs do not exist (Standard Assortment Packs of three 250 ml **Eaches** or Standard Assortment Packs of three 200 ml **Eaches** do not exist). As the promotional module must refer to commercialised non Promotional Trade Items, the module must detail the relationship to both the Promotional **Each** (that contains 250 ml) and the relationship of the Standard **Each** (that contains 200 ml).

At the **PACK_OR_INNER_PACK** level, the Promotional Item Information Module is repeated three times for each of the unique Promotional **Eaches** contained in the Promotional Assortment Pack:

1st repetition:

- **freeQuantityOfNextLowerLevelTradeItem** = 50 ml
- **nonPromotionalTradeItem** = GTIN for the first Standard **Each** (200 ml)
- **promotionTypeCode** = **MULTI_PACK_AND_COMBINATION_PACK**

2nd repetition:

- **freeQuantityOfNextLowerLevelTradeItem** = 50 ml
- **nonPromotionalTradeItem** = GTIN for the second Standard **Each** (200 ml)
- **promotionTypeCode** = MULTI_PACK_AND_COMBINATION_PACK

3rd repetition:

- **freeQuantityOfNextLowerLevelTradeItem** = 50 ml
- **nonPromotionalTradeItem** = GTIN for the third Standard **Each** (200 ml)
- **promotionTypeCode** = MULTI_PACK_AND_COMBINATION_PACK

At base unit #1 (BASE_UNIT_OR_EACH level), the Promotional Item Information Module is used as follows:

- **freeQuantityOfProduct** = 50 ml
- **nonPromotionalTradeItem** = GTIN for the first Standard **Each** (200 ml)
- **promotionTypeCode** = BONUS_PACK

At base unit #2 (BASE_UNIT_OR_EACH level), the Promotional Item Information Module is used as follows:

- **freeQuantityOfProduct** = 50 ml
- **nonPromotionalTradeItem** = GTIN for the second Standard **Each** (200 ml)
- **promotionTypeCode** = BONUS_PACK

At base unit #3 (BASE_UNIT_OR_EACH level), the Promotional Item Information Module is used as follows:

- **freeQuantityOfProduct** = 50 ml
- **nonPromotionalTradeItem** = GTIN for the third Standard **Each** (200 ml)
- **promotionTypeCode** = BONUS_PACK

- **Note:** The only way to describe this scenario is to repeat the information within the Promotional Item Information Class.

Example 2:

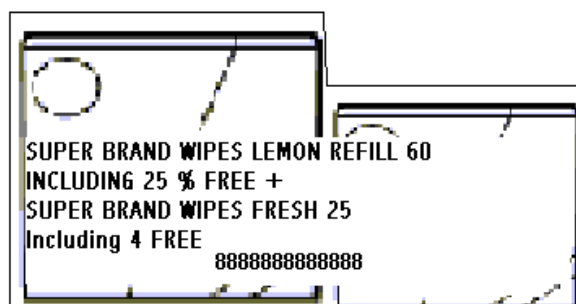

The **Eaches** contained within the Assortment Pack are also promotional. This Promotional Assortment Pack offers 25% of a wipes refill for free in addition to a package of 25 wipes that includes 4 free wipes.

At the PACK_OR_INNER_PACK level, the Promotional Item Information Module is repeated twice:

1st repetition:

- **freeQuantityOfNextLowerLevelTradeItem** = 15 PC

- **nonPromotionalTradeItem** = GTIN for the first Standard **Each** (box of lemon wipes)
- **promotionTypeCode** = MULTI_PACK_AND_COMBINATION_PACK

2nd repetition:

- **freeQuantityOfNextLowerLevelTradeItem** = 4 PC
- **nonPromotionalTradeItem** = GTIN for the second Standard **Each** (box of Fresh wipes)
- **promotionTypeCode** = MULTI_PACK_AND_COMBINATION_PACK

At base unit #1 (BASE_UNIT_OR_EACH level), the Promotional Item Information Module is used as follows:

- **freeQuantityOfProduct** = 15 PC
- **nonPromotionalTradeItem** = GTIN for the first Standard **Each** (box of lemon wipes)
- **promotionTypeCode** = FREE_COMPONENTS

At base unit #2 (BASE_UNIT_OR_EACH level), the Promotional Item Information Module is used as follows:

- **freeQuantityOfProduct** = 4 PC
- **nonPromotionalTradeItem** = GTIN for the second Standard **Each** (box of Fresh wipes)
- **promotionTypeCode** = FREE_COMPONENTS

- **Note:** The only way to describe this scenario is to repeat the information within the Promotional Item Information Class.

17.6.2 "Low Price" Promotion, no Free Quantity Specified

This Promotional Trade Item is a special "low price" promotion that does not specify the free quantity. This type of promotion requires a different GTIN (see the note below); the Promotional Trade Item and the Standard Trade Item do not share the same GTIN. This section includes the price reduction explicitly specified on the pack (flash packs).

In this case:

- The **freeQuantityOfNextLowerLevelTradeItem** and **freeQuantityOfProduct** attributes are not used.
 - The **promotionTypeCode** attribute still contains the same "FREE_QUANTITY" code name.
 - The **nonPromotionalTradeItem** attribute contains the associated Standard Trade Item's GTIN
- **Note:** In the actual GTIN Management Standard, the special "Low Price" or "Special Price" promotions case is not specified. This guide requires allocating a new GTIN to enforce the change of price at the point-of-sale. Indeed, the possible coexistence of the Promotional and Standard Trade Items at the point-of-sale induces a need for a different GTIN to identify the Promotional Trade Item as its price is lower.

17.6.2.1 1st Scenario – Price reduction for a Promotional Each

The Promotional Trade Item is an Each.

The Promotional **Each** shares the same net content as the Standard **Each** but the consumer is charged less when buying the Promotional **Each**. The amount of free quantity is not indicated on the packaging; only "special offer" is displayed. The new price is not displayed

At the BASE_UNIT_OR_EACH level, the Promotional Item Information Module uses the following attributes:

- **nonPromotionalTradeItem:** GTIN for a standard base unit
- **promotionTypeCode:** FREE_QUANTITY

Example:



The Promotional Item Information Module is used as follows:

- **nonPromotionalTradeItem:** GTIN for a standard base unit
- **promotionTypeCode:** FREE_QUANTITY

17.6.2.2 2nd Scenario – Price Reduction for a Promotional Multipack or Promotional Assortment Pack built from a Multipack or Assortment Pack

The Promotional Trade Item comes in either a Multipack or an Assortment Pack that shares the same format, net content and characteristics as the Standard Multipacks or Assortment Packs.

The Promotional Multipack or Assortment Pack shares the same net content as a Standard Multipack or Assortment Pack but the consumer is charged less when buying the promotional pack than when buying the standard pack. The amount of free quantity is not indicated on the packaging; only “special offer” is displayed.

At the PACK_OR_INNER_PACK level (Multipack or Assortment Pack), the Promotional Item Information Module uses the following attributes:

- **nonPromotionalTradeItem:** GTIN for the standard pack that is used as a promotional base
- **promotionTypeCode:** FREE_QUANTITY

17.6.2.3 3rd Scenario – Price Reduction for a Promotional Multipack built from a Standard Each

The Promotional Trade Item comes in a Multipack which for a Standard Multipack does not exist.

The Promotional Trade Item is a Multipack. The Standard Multipack does not exist, thus the Standard Trade Item is the **Each**, component of the pack. The consumer is charged less when buying the Promotional Multipack than when buying individually the components within the Multipack. The amount of free quantity is not indicated on the packaging; only “special offer” is displayed.

At the PACK_OR_INNER_PACK level, the Promotional Item Information Module uses the following attributes:

- **nonPromotionalTradeItem:** GTIN for the Standard **Each** contained within the Promotional Multipack
- **promotionTypeCode:** FREE_QUANTITY

Example:

The Promotional Multipack is made up with twice the same box of facial tissues. The consumer is charged less when buying the Promotional Multipack than when buying two boxes of facial tissues. The amount of free quantity is not indicated on the packaging; only "special offer" is displayed.

A standard two box Multipack does not exist. The Standard Trade Item is therefore the Standard **Each** included in the pack, i.e. the box of facial tissues.

At the PACK_OR_INNER_PACK level, the Promotional Item Information Module uses the following attributes:

- **nonPromotionalTradeItem:** GTIN for the Standard **Each** (box of facial tissues)
- **promotionTypeCode:** FREE_QUANTITY

17.6.2.4 4th Scenario – Price Reduction for a Promotional Assortment Pack built from a Standard Each

The Promotional Trade Item is an Assortment Pack which for a Standard Assortment Pack does not exist

The Promotional Trade Item is an Assortment Pack. The Standard Assortment Pack does not exist, thus the Standard Trade Items are the Standard **Eaches** included in the Assortment Pack.

The consumer is charged less when buying the promotional pack than when buying individually the components of the pack. The amount of free quantity is not indicated on the packaging; only "special offer" is displayed.

The Promotional Item Information Module is repeated at the PACK_OR_INNER_PACK level for every different **Each** contained in the pack. The Promotional Item Information Module uses the following attributes:

- **nonPromotionalTradeItem:** GTIN for one of the Standard **Eaches** contained in the promotional pack.
- **promotionTypeCode:** FREE_QUANTITY
- **Note:** For the 3rd scenario and the 4th scenario, if the promotional pack contains **Eaches** that are promotional ("Low Price" promotion type), the Promotional Item Information Module is used both at PACK_OR_INNER_PACK level (Multipack or Assortment Pack) and at the BASE_UNIT_OR_EACH level with **promotionTypeCode:** FREE_QUANTITY.

17.6.3 Promotional Contest or Coupon

This type of promotion does not require a change in GTIN for its promotional consumer units and therefore cannot use the Promotional Item Information Module to specify details of the promotion. One option is to communicate the promotion by allocating a new GTIN for the logistic units (e.g. case or pallet) (if the promotion is targeting a certain time frame or clientele). Another option is to use the attribute **offerOnPack** and the other descriptive fields in the TradeItem document.

17.6.4 Free sample (That Cannot be Sold Separately to a Consumer)

- **Note:** Depending on local regulations, if the net content of a free sample is over a specific threshold (identified by the regulation), it might be considered part of the Standard Trade Item's net content and be included in the price difference, even if the contents of the Standard Trade Item and sample are heterogeneous.

The [GS1 GTIN Management Standard](#) indicate that if the net content's adjustment is declared by the provider, a new GTIN must be created specifically for the new consumer unit.

Samples with a net content which is lower than the specific threshold

There is little chance that the promotion will require a change in GTIN. Therefore, it is impossible to use the Promotional Item Information Module as an outline guide.

One option is to communicate the promotion by allocating a new GTIN for the logistic units (e.g. case or pallet) (if the promotion is targeting a certain time frame or clientele). Another option is to use the attribute **offerOnPack** and the other descriptive fields in the TradeItem document.

If the promotion requires a change in GTIN (because, according to GS1 stipulations, the dimensional increase of the promotional product exceeds 20% of the standard product's dimensions) and if the contents of the sample are not considered part of the net content of the Promotional Trade Item, the free quantity does not need to be indicated.

At the BASE_UNIT_OR_EACH level, the Promotional Item Information Module uses the following attributes:

- **nonPromotionalTradeItem:** GTIN for the standard base unit
- **promotionTypeCode:** SAMPLE

Samples with a net content which is greater than the specific threshold

When the promotion requires a change in GTIN (because, according to GS1 stipulations, the dimensional increase of the promotional product exceeds 20% of the Trade Item's dimensions), the sample's contents will be considered part of the net content of the Promotional Trade Item. It is therefore a free quantity.

At the BASE_UNIT_OR_EACH level, the Promotional Item Information Module use the following attributes:

- **freeQuantityOfProduct:** free sample content quantity
- **nonPromotionalTradeItem:** GTIN for the Standard Trade Item
- **promotionTypeCode:** SAMPLE

17.6.5 Free Gift

This Promotional Trade Item includes a free gift which cannot be sold separately to a consumer.

No need for GTIN change

Providing that the Promotional Trade Item's dimensions remain within the GS1 standard limit (20%) of the Standard Trade Item, there is no change in GTIN and is therefore impossible to use the Promotional Item Information Module as an outline guide.

One option is to communicate the promotion by allocating a new GTIN for the logistic units (e.g. case or pallet) (if the promotion is targeting a certain time frame or clientele). Another option is to use the attribute **offerOnPack** and the other descriptive fields in the TradeItem document.

Need for GTIN change

When a free item exceeds the dimension limits defined by GS1 standards (20%), the Promotional Trade Item and Standard Trade Item do not share the same GTIN, therefore at the BASE_UNIT_OR_EACH level, the Promotional Item Information Module is used as follows:

- **nonPromotionalTradeItem:** GTIN for the Standard Trade Item
- **promotionTypeCode:** FREE_GIFT_ATTACHED

Example:



In the example, the bottle of alcoholic beverage on the left is the Standard Trade Item. The promotion attaches a free empty display bottle for the consumer to use in conjunction with enjoying the alcoholic beverage.

17.6.6 Unique Packaging (ex: Tin Box)

No need for GTIN change

Providing that the Promotional Trade Item’s dimensions remain within the GS1 standard limit (20%) of the Standard Trade Item, there is no change in GTIN and is therefore impossible to use the Promotional Item Information Module as an outline guide.

The promotion is outlined by logistic units and uses the attribute offerOnPack and the other descriptive fields in the TradeItem document.

Need for GTIN change

When a free item exceeds the dimension limits defined by GS1 standards (20%), the Promotional Trade Item and Standard Trade Item do not share the same GTIN, therefore at the BASE_UNIT_OR_EACH level, the Promotional Item Information Module is used as follows:

- **nonPromotionalTradeItem:** GTIN for the Standard Trade Item
- **promotionTypeCode:** SPECIAL_PACKAGING

Example:



In the example, the bottle of alcoholic beverage on the left is the Standard Trade Item. The promotion consists of an attractive metal “tin” as celebration packaging for the standard item. This is particularly common for special events and seasonal celebrations.

18 Packaging, Platform Information Module

The goal of this section is to provide some useful information regarding the content and use of new code lists for packaging types, packaging material and platform types.

18.1 Who Will Use this?

This guide is intended for all trading partners – both information providers and information recipients – who synchronise product packaging information through GDSN in order to support their business and supply chain. The current guide was created primarily by participants that hail from the FMCG sector; however, these recommendations and principles apply to all environments and verticals where the referred code lists are in use.

18.2 Code Lists Packaging Type

The following section provides reference regarding the use of the packaging type code list and related complementary information. The information for packaging type is mainly communicated through the following attributes:

- **packagingTypeCode:** used to express the main packaging types that are present in the trade item (e.g. a box).
 - **packagingFeatureCode:** A packaging feature that facilitates the usage of the product by the consumer. Features do not affect the core composition of the packaging type nor modify its usage.
 - **packagingFunctionCode:** used to express a particular functionality that the packaging may be able to perform due to its properties (e.g. Anti-Tampering, vacuum-packaged, etc.)
 - **packagingShapeCode:** A code depicting the shape of a package for example cone.
- **Note:** For the official definitions of these attributes please see [GS1 Navigator, GDSN](#).
 - **Note:** New with Major Release 3.1 the packaging Material Type Code is now associated to the packaging Type.

The attributes mentioned above can be used in conjunction to convey more granular or specific information to describe the packaging of a trade item.

The **packaging type** of a trade item refers to each of the various types of packaging that contributes to the trade items structural integrity and characteristics in its final distribution form (i.e. how it is made available to the end user of the product).

- **Note:** Multiple packaging types may be specified. In case more than one packaging type is provided the first one in the sequence should always be considered as the prevalent packaging type.

18.2.1 Pre-Requisite

The data source must have access to corroborated factual information of the packaging characteristics (desirably physically verifiable) for each item in a given hierarchy.

18.2.2 When Would I Use This?

Packaging information for a trade item is set up as part of the trade item data that is communicated by trading partners.

Therefore, it is assumed when an organisation makes use of these attributes, it is because trading partners have agreed to synchronise packaging information through GDSN.

18.2.3 How to Express the Packaging Type of the Trade Item?

Packaging type information is populated in the following fashion:

- Use **packagingTypeCode** to indicate the main type of packaging present in the trade item. This information is always available and can always be provided, though the attribute is not mandatory and can be left blank.
 - **Note:** Even in the case of trade items that do not have any packaging at all, or whose packaging is impossible to identify this information can still be provided by expressing that the packaging is unspecified (code PUG) or that the item is not packed (code NE).
- Utilise **packagingFunctionCode**, **packagingFeatureCode**, **packagingShapeCode** and **packagingMaterialTypeCode** to indicate whether the packaging performs a particular functionality or provides specific features, shape, and materials. Not all packaging types have this type of information associated with them, so this information may not apply to all trade items.
 - **Note:** While in a substantial number of cases it is the packaging that is responsible for the form of a trade item, it is important to point out that the form of the trade item is in essence independent to the packaging type. A trade item may have no packaging and still have a defined form.
- Utilise the packaging material attributes to specify the material(s) of which the packaging of the trade item is composed.



18.2.3.1 How to Determine the Packaging Type

First step to identify to set up a trade item’s packaging information is to determine what the packaging type is. In order to select the principal packaging type in a trade item, one must look for the prevalent type of packaging present. *Prevalent* can be defined as the part of the packaging that fulfils one or a combination of the following traits:

- Gives the trade item structural form or shape
- Is the largest single packaging element in the item
- Is the most abundant single packaging element in the trade item
- Contains the bulk of the trade items information and imaging
- Is essential for the preservation of the trade item’s integrity

Examples of prevalent packaging type determination:

Example	Prevalent packaging type	Rationale:
<p>Crate of beer</p> 	Crate	It is the main packaging element in the item in this level of the hierarchy and provides structural integrity for the article.

Example	Prevalent packaging type	Rationale:
<p>Chocolates</p> 	Box	It is the main packaging element in the item in this level of the hierarchy and provides structural integrity for the article. It also contains the most important information about the product.
<p>Cola Tray</p> 	Tray	Even though the outermost packaging element is a layer of shrink-wrap, the main packaging element in the item is still the tray that provides the structural integrity for the article. It is the most significant proportion of packaging and makes it possible to move the trade item around as a whole. (The shrinkwrap can be specified as an additional feature of the packaging).
<p>Soap</p> 	Pouch	That is the packaging element that provides the structural integrity for the article, and has the most important information of the item.

18.2.3.2 How to Select a Packaging Type Code

Once the prevalent packaging type has been identified, the next step is to select the appropriate code from the applicable code list that will be used to convey what the packaging type is to trading partners.

- Important:** Different terminology may be used across different countries and different industries to address what is in essence the same basic type of packaging; considering that standardisation is essential for an efficient communication of information, the standard list acknowledges only the foremost name given to packaging types. There is however a glossary of alternative terms used for the basic packaging types which can help orientate those that may be familiar with an alternative name for a packaging type.

In the event that the term traditionally used for the identified prevalent packaging type is not included in the **packagingTypeCode** please make use of the table below which lists the alternative names for packaging types.

Table 18-1 Alternative Names for Packaging Types

Packaging Terms	Consider Using	Other attributes to support
Ammo Pack	Box	packagingFeatureCode= INTERNAL_DIVIDER
Ampoule non-protected	Ampoule	
Ampoule protected	Ampoule	packagingFunctionCode= PROTECTED
Attachment	Select appropriate packagingTypeCode	check the packagingFeatureCode for a full list
Bag sift proof	Bag	packagingFunctionCode= SIFT_PROOF
Bag super bulk	Bag	

Packaging Terms	Consider Using	Other attributes to support
Bag without inner coat/liner	Bag	
Bag, large	Bag	
Bag, multiply	Bag	
Bag, pinpack	Bag	packagingFunctionCode=PINPACK
Bag, water resistant	Bag	packagingFunctionCode=WATER_RESISTANT
Bale	Banded Package	
Bale, compressed	Banded Package	packagingFunctionCode=COMPRESSED
Bale, non-compressed	Banded Package	
Balloon, non-protected	Bottle	
Balloon, protected	Bottle	packagingFunctionCode= PROTECTED
Ballot, paquet	Box or Packed unspecified	
Banding	Banded Package	
Barge	Should not be used as it is not a packaging type.	
Barrel bung type	Barrel	packagingFeatureCode=BUNG_SEAL
Basin	Cup/Tub	
Beam	Select appropriate packagingTypeCode	packagingFeatureCode=BEAM
Belting	Banded Package	
Big Bag / Tote	Bag	
Bin	select an appropriate packagingTypeCode or use Rigid Intermediate Bulk Container from the Platform Type Code List	
Bing Chest	select an appropriate packagingTypeCode or use Rigid Intermediate Bulk Container from the Platform Type Code List	
Blister, pinpack	Blister pack	packagingFunctionCode=PINPACK
Board in bundle/bunch/truss	Card	
Board in pack/sheaf/bunch	Card	
Board, clip	Card	
Board, pinpack	Card	packagingFunctionCode=PINPACK
Bobbin	Reel	
Bolt	Reel	
Bottle, crate	Crate	
Bottle, gas	Bottle	
Bottle, non-protected bulbous	Bottle	
Bottle, non-protected, cylindrical	Bottle	packagingShapeCode=CYLINDRICAL
Bottle, wicker	Bottle	packagingFeatureCode=WICKER_OUTER_CONTAINER
Bottlecrate, bottlerack	Crate or Rack	
Bowl/Cup/Tub	Cup/Tub	
Box, composite	Box	packagingMaterialTypeCode=COMPOSITE

Packaging Terms	Consider Using	Other attributes to support
Box, sift proof walls	Box	packagingFunctionCode= SIFT_PROOF
Box, slite	Box	
Box, with inner container	Box	packagingFeatureCode= INNER_CONTAINER
Bracing	Banded Package	
Bucket/Pail	Bucket	
Bulk	select an appropriate packagingTypeCode or use Rigid Intermediate Bulk Container from the Platform Type Code List	
Bulk Container	Flexible Intermediate Bulk Container	
Bundle	Banded Package	
Butt	Barrel	
Cabinet	Select appropriate packagingTypeCode	
Cage, roll	Cage	doesPackagingHaveWheels=TRUE
Can, cylindrical	Can	packagingShapeCode=CYLINDRICAL
Can, other shape	Can	packagingShapeCode=UNSPECIFIED
Can, rectangular	Can	packagingShapeCode=RECTANGULAR
Can, with handle and spout	Can	packagingFeatureCode=HANDLE packagingFeatureCode=SPOUT
Canister	Can	
Capsule	Jar	
Car Load, Rail	Should not be used as it is not a packaging type. Replaced by TradeItemUnitDescriptorCode (Code Value "TRANSPORT_LOAD"); transportationModeCode = GROUND. If packagingTypeCode is needed, use PUG Packed, unspecified"	
Carboy	Barrel	some packagingFeatureCode codes may apply
Carboy non-protected	Barrel	some packagingFeatureCode codes may apply
Carboy protected	Barrel	packagingFunctionCode= PROTECTED, some packagingFeatureCode codes may apply
Card/Cage	Card	
Cardboard carrier	Tray	Populate appropriate packagingMaterialTypeCode
Case, isothermic	Case	packagingFunctionCode= ISOTHERMIC
Case, skeleton	Case	
Cask	Barrel	
Cellplate	Tray	
Chest	select an appropriate packagingTypeCode or use Rigid Intermediate Bulk Container from the Platform Type Code List	
Churn	Jug	
Clamshell	Clamshell	

Packaging Terms	Consider Using	Other attributes to support
Coil	Banded Package	
Composite packaging glass receptacle	Select appropriate packagingTypeCode	
Composite packaging plastic receptacle	Select appropriate packagingTypeCode	
Cones	Select appropriate packagingTypeCode	packagingShapeCode=CONE
CONEX	Should not be used as it is not a packaging type. Replaced by TradeItemUnitDescriptor Code (Code Value "TRANSPORT_LOAD"); transportationModeCode = GROUND If packagingTypeCode needed use PUG Packed, unspecified	
Container	select an appropriate packagingTypeCode or use Rigid Intermediate Bulk Container from the Platform Type Code List	
Container bottle like	Bottle, box, or select an appropriate packagingTypeCode	
Container non-protected	Bottle, box, or select an appropriate packagingTypeCode	
Container protected	Bottle, box, or select an appropriate packagingTypeCode	packagingFunctionCode= PROTECTED
Container, Commercial Highway Lift	Should not be used as it is not a packaging type. Replaced by TradeItemUnitDescriptor Code (Code Value "TRANSPORT_LOAD"); transportationModeCode = GROUND If packagingTypeCode needed use PUG Packed, unspecified	
Container, Engine	Should not be used as it is not a packaging type. Replaced by TradeItemUnitDescriptor Code (Code Value "TRANSPORT_LOAD"); transportationModeCode = GROUND If packagingTypeCode needed use PUG Packed, unspecified	
Container, MAC-ISO, LT. WGT. 8x8x20 Foot Air	Should not be used as it is not a packaging type. Replaced by TradeItemUnitDescriptor Code (Code Value "TRANSPORT_LOAD"); transportationModeCode = GROUND If packagingTypeCode needed use PUG Packed, unspecified	
Container, Multi-walled, Secured to Warehouse Pallet	select an appropriate packagingTypeCode or use Rigid Intermediate Bulk Container from the Platform Type Code List	
Container, Navy Cargo Transporter	Should not be used as it is not a packaging type. Replaced by TradeItemUnitDescriptor Code (Code Value "TRANSPORT_LOAD"); transportationModeCode = GROUND If packagingTypeCode needed use PUG Packed, unspecified	
Containers of Bulk Cargo	select an appropriate packagingTypeCode or use Rigid Intermediate Bulk Container from the Platform Type Code List	

Packaging Terms	Consider Using	Other attributes to support
Core	Use code 'Not Packed' and attribute tradeItemFormDescription instead	
Corner Reinforcement	Select appropriate packagingTypeCode	packagingFunctionCode=REINFORCED and/or packagingFeatureCode=EDGE_PROTECTION
Cradle	select an appropriate packagingTypeCode or use Rigid Intermediate Bulk Container from the Platform Type Code List	
Crate, Corner Reinforcement	Crate	packagingFunctionCode= REINFORCED and/or packagingFeatureCode=EDGE_PROTECTION
Crate, multiple layer, cardboard	Crate	packagingFeatureCode=INTERNAL_DIVIDER
Crate, multiple layer, plastic	Crate	packagingFeatureCode=INTERNAL_DIVIDER
Crate, multiple layer, wooden	Crate	packagingFeatureCode=INTERNAL_DIVIDER
Crate, reusable	Crate	
Demijohn, non-protected	Bottle	
Demijohn, protected	Bottle	packagingFunctionCode= PROTECTED
Dispenser	Select appropriate packagingTypeCode	packagingFunctionCode= DISPENSER
Double-length Rack	Rack	
Double-length Skid	Use code 'Packed, Unspecified'	platformTypeCode could be 44 - Skid
Double-length Tote Bin	select an appropriate packagingTypeCode or use Rigid Intermediate Bulk Container from the Platform Type Code List	
Drum	Barrel	
Dry Bulk	select an appropriate packagingTypeCode or use Rigid Intermediate Bulk Container from the Platform Type Code List	
Duffle bag	Bag	
Edge Protection	Select appropriate packagingTypeCode	packagingFeatureCode=EDGE_PROTECTION
Egg Container	Carton	packagingFeatureCode=INTERNAL_DIVIDER
Envelope, small sealed	Envelope	
Filmpack	Wrapper	
Firkin	Barrel	
Flask	Bottle	
Flo-bin	select an appropriate packagingTypeCode or use Rigid Intermediate Bulk Container from the Platform Type Code List	
Flow Wrapped	Wrapper	
Flowpack	Wrapper	
Foil	Wrapper	
Forward Reel	Reel	
Frame	Rack	

Packaging Terms	Consider Using	Other attributes to support
Girders in bundle/bunch/truss	Banded package	
Half-Standard Rack	Rack	
Half-Standard Tote Bin	select an appropriate packagingTypeCode or use Rigid Intermediate Bulk Container from the Platform Type Code List	
Hamper	Basket	
Hanger Rack	Rack	
Hogshead	Barrel	
Hopper Truck	Should not be used as it is not a packaging type. Replaced by TradeItemUnitDescriptor Code (Code Value "TRANSPORT_LOAD"); transportationModeCode = GROUND If packagingTypeCode needed use PUG Packed, unspecified	
Household Goods Container,	Packed, Unspecified	
Intermodal Trailer/Container Load (Rail)	select an appropriate packagingTypeCode or use Rigid Intermediate Bulk Container from the Platform Type Code List	
Jerrican	Bottle	
Jutebag	Bag	
Keg	Barrel	
Kit	Multipack	
Knockdown Rack	Rack	
Knockdown Tote Bin	select an appropriate packagingTypeCode or use Rigid Intermediate Bulk Container from the Platform Type Code List	
Label Tag	Select appropriate packagingTypeCode	packagingFeatureCode=LABEL
Lift Van	Should not be used as it is not a packaging type. Replaced by TradeItemUnitDescriptor Code (Code Value "TRANSPORT_LOAD"); transportationModeCode = GROUND If packagingTypeCode needed use PUG Packed, unspecified	
Lifts	Select appropriate packagingTypeCode	packagingFeatureCode=HANDLE
Liners	Select appropriate packagingTypeCode	packagingFeatureCode=LINER
Lip/Top	Select appropriate packagingTypeCode	packagingFeatureCode=LID
Log	Use code 'Not Packed' or Select appropriate packagingTypeCode	
Loose	Not Packed	variableTradeItemTypeCode=LOOSE
Lug	Select appropriate packagingTypeCode	packagingFeatureCode=LUG
Matchbox	Box	
MILVAN	select an appropriate packagingTypeCode or use Rigid Intermediate Bulk Container from the Platform Type Code List	
Mixed	use packaging Unspecified or indicate two packaging types	

Packaging Terms	Consider Using	Other attributes to support
Mixed Container Types	use packaging Unspecified or indicate two packaging types	
MSCVAN	select an appropriate packagingTypeCode or use Rigid Intermediate Bulk Container from the Platform Type Code List	
Multi-Roll Pack	Multipack	
Noil	Packed unspecified	Use 'Cloth or Fabric' to Populate appropriate packagingMaterialTypeCode
Not available	Packed unspecified	
Not wrapped	Not Packed	
On Hanger or Rack in Boxes	Rack	consider using doesItemComeWithHanger
On Own Wheel	select an appropriate packagingTypeCode	doesPackagingHaveWheels=TRUE
Other	Packed unspecified	
Over Wrapped	Wrapper	
Pack	Packed unspecified or Multipack	
Package	Packed, Unspecified	
Package with bottle grip-holes cardboard	Multipack	packagingFeatureCode=HANDLE, and Populate appropriate packagingMaterialTypeCode
Package, paper wrapped	Wrapper	Populate appropriate packagingMaterialTypeCode
Packed Aluminium	Packed unspecified	Populate appropriate packagingMaterialTypeCode
Packet	Wrapper	
Pail	Bucket	
Pallet - 2 Way	Pallet	
Pallet - 4 Way	Pallet	
Paper	Wrapper	Populate appropriate packagingMaterialTypeCode
Parcel	Packed unspecified	
Partitioning	select an appropriate packagingTypeCode	packagingFeatureCode=INTERNAL_DIVIDER
Pieces	Not Packed or Unspecified	
Pinpack	Card	packagingFunctionCode=PINPACK
Pipe Rack	Rack	
Pipeline	Use code 'Not Packed' or select appropriate packaging type	
Pipes in bundle/bunch/truss	Banded Package	
Pipes in pack, sheaf, bunch	Banded Package	
Pirns	Reel	
Pitcher	Jar or Jug	packagingFeatureCode=HANDLE
Planks in bundle/bunch/truss	Banded Package	
Plant Container	Packed unspecified	

Packaging Terms	Consider Using	Other attributes to support
Plastic-Wrapped Tray	Tray	packagingFeatureCode=WRAP and Populate appropriate packagingMaterialTypeCode
Plate	Tray	
Plates in bundle/bunch/truss	Banded Package	
Plates in pack, sheaf, bunch	Banded Package	
Platform	packagingTypeCode could be Pallet	Use the appropriate code from the platform type code list.
Pocket	Bag or Pouch or Envelope	
Potato container	Pallet Box or Box	
Primary Lift Container	select an appropriate packagingTypeCode or use Rigid Intermediate Bulk Container from the Platform Type Code List	
Private Vehicle	Should not be used as it is not a packaging type. Replaced by TradeItemUnitDescriptor Code (Code Value "TRANSPORT_LOAD"); transportationModeCode = GROUND If packagingTypeCode needed use PUG Packed, unspecified	
Punnet	Basket	
Rail (Semiconductor)	Tube	
Rednet	Net	
Reinforcement	Select appropriate packagingTypeCode	packagingFunctionCode= REINFORCED
Retort	Ampoule	
Reverse Reel	Reel	
Rod	Cylinder	
Rods in bundle/bunch/truss	Banded Package	
Roll Cage	Cage	doesPackagingHaveWheels=TRUE
Roll container	Pallet Box	doesPackagingHaveWheels=TRUE
Sachet / Stickpack	Envelope or Wrapper	
Sack	Bag	
SEAVAN	Packed, Unspecified	
Separator/Divider	select an appropriate packagingTypeCode	packagingFeatureCode=INTERNAL_DIVIDER
Set	Multipack	
Sheet	Use the appropriate code from the platform type code list.	
Sheets in bundle/bunch/truss	Banded Package	
Shook	Banded Package	
Shrinkwrap	Shrinkwrapped	
Skid	Use pallet	platformTypeCode = 44 - Skid
Skid, elevating or lift truck	Use pallet	platformTypeCode = 44 - Skid
Slip Sheet	Use pallet	platformTypeCode = 9 - Slip Sheet
Spin Cylinders	Tube	

Packaging Terms	Consider Using	Other attributes to support
Splash Blend	use appropriate packaging Type Code	Recommended this type of information be placed in tradeItemDescription or additionalTradeItemDescription
Spool	Reel	
Stick Pack	Wrapper	
Suitcase	Case	
Tank	Cylinder	
Tank Car	Should not be used as it is not a packaging type. Replaced by TradeItemUnitDescriptorCode (Code Value "TRANSPORT_LOAD"); transportationModeCode = GROUND If packagingTypeCode needed use PUG Packed, unspecified	
Tank Truck	Should not be used as it is not a packaging type. Replaced by TradeItemUnitDescriptor Code (Code Value "TRANSPORT_LOAD"); transportationModeCode = GROUND If packagingTypeCode needed use PUG Packed, unspecified	
Tetrapack	Brick or Gable Top	
Three pack	Multipack	
Tierce	Barrel	
Tote Bin	Packed unspecified or Pallet Box	
Tray for bottles	Tray	
Tray one layer no cover	Tray	
Tray, Shrinkwrap	Tray	
Tray/Tray pack	Tray	
Trolley	Cage or Rack	
Truck	Should not be used as it is not a packaging type. Replaced by TradeItemUnitDescriptor Code (Code Value "TRANSPORT_LOAD"); transportationModeCode = GROUND If packagingTypeNeeded use PUG Packed, unspecified	
Trunk and Chest	Basket	
Trunk, Salesmen Sample	Case	
Tub with lid	Cup/Tub	packagingFeatureCode=LID
Tube collapsible	Tube	
Tube, test	Tube	
Tube, with nozzle	Tube	packagingFeatureCode=SPOUT
Tubes in bundle/bunch/truss	Banded Package	
Tun	Barrel	
Two pack	Multipack	
Two sided cage on wheels with fixing strap	Cage	doesPackagingHaveWheels=TRUE
Uncaged	Not packed	

Packaging Terms	Consider Using	Other attributes to support
Unit	Not Packed or Unspecified	
Unpacked or unpackaged	Not Packed	
Van Pack	Should not be used as it is not a packaging type. Replaced by TradeItemUnitDescriptor Code (Code Value "TRANSPORT_LOAD"); transportationModeCode = GROUND If packagingTypeNeeded use PUG Packed, unspecified	
Vat	Barrel	
Vehicle in Operating Condition	Should not be used as it is not a packaging type. Replaced by TradeItemUnitDescriptor Code (Code Value "TRANSPORT_LOAD"); transportationModeCode = GROUND If packagingTypeNeeded use PUG Packed, unspecified	
Vehicles	Should not be used as it is not a packaging type. Replaced by TradeItemUnitDescriptor Code (Code Value "TRANSPORT_LOAD"); transportationModeCode = GROUND If packagingTypeNeeded use PUG Packed, unspecified	
Vial	Case or Bottle	
Wheeled Carrier	Select appropriate packagingTypeCode	doesPackagingHaveWheels=TRUE
Wrapped	Wrapper	
Wrapped in Plastic	Wrapper	Populate appropriate packagingMaterialTypeCode







- **Note:** There are also other various types which are in use among trading partners today but are not supported in the current packaging type code list. These packaging types do not always map directly to a code from the current code list. The reason why they don't have a one-to-one match is that many of these codes do not represent a packaging type but other characteristics instead.

Below we include some considerations and examples for an appropriate selection of a packaging type code. These examples have been selected as they apply to types of products that are commonly a source of confusion.

- **Note:** These examples represent general guidelines. Trading partners should decide on the best packaging type for each product based on its individual characteristics.

Table 18-2 Examples of Packaging Type Codes

Example	Illustration	Description
Pallet Box		This packaging type is used for the sort of products seen below which cannot be handled without a platform and in most cases have the platform permanently attached. If the packaging can be handled without a platform, other codes such as "Crate" and "Box" should be used instead.

Example	Illustration	Description
<p>Gable-Top</p>		<p>Gable-tops are per definition not stackable as their top has always a protuberance that prevents them to be stacked. Note that the term "Gable-top" is used almost exclusively for containers for comestible perishable liquids such as juice, milk, yoghurts, etc.</p>
<p>Brick</p>		<p>Contrary to the "Gable-top", a "Brick" is always stackable and has a flat top as a norm. Note that the term "Brick" is used almost exclusively for containers for comestible perishable liquids such as juice, milk, yoghurts, etc.</p>
<p>Case</p>		<p>Used to describe a packaging type which besides the basic functions of packaging, serves as a sheath, shell or armour for the trade item. A case it's usually not disposable or has a life-span at least as long as that of the product and/or content itself. Important: Therefore, within the context of determining the packaging type, the term "Case" is never intended to be used as a synonym for a shipping unit of merchandise.</p>
<p>Carton</p>		<p>Refers to mostly re-closable containers for fresh foods such as eggs, fruit etc. Important: Within the context of packaging type descriptions, the term "Carton" is not intended to be used for the definition of the packaging type for liquids such as milk and juice. For those cases please refer to the codes "Brick" and "Gable-top". Important: The usage of 'carton' as a packaging type is completely detached from the material of which a 'carton' type container is made. Therefore, there may be items with a packaging classified as a 'carton' made out of plastic or others materials. Please not that when selecting this code.</p>
<p>Wrapper</p>		<p>Used for all instances of packaging made of wrapping materials which are later on sealed along the edges. This covers virtually all wrapper variations with the exception of shrink-wrap and stretch-wrap which are not sealed in the same fashion.</p>
<p>Shrink-wrap and Stretch-wrap</p>		<p>These two packaging types are only to be used when there is no other packaging type present in the article than the shrink/stretch-wrap itself. These types of packaging will typically apply to pallet units where the only packaging for the entire pallet load is the shrink/stretch-wrap.</p>

Example	Illustration	Description
<p>Multi-pack</p>		<p>This term is to be utilised when the trade item is a set of multiple units whose prevalent packaging cannot be described with a specific packaging type or is a derivation of the packaging of the individual units.</p> <p>Note: Trade items with a “Multi-pack” packaging type must always be consumer units. To provide more detail about the type of packaging used in a “Multi-pack” refer to section 18.2.3</p>
<p>Pouch</p>	<p>This is a “Pouch” This is a “Bag”</p> 	<p>A “Pouch” differentiates from a “Bag” because pouches do always have a base which was made with the purpose of allowing the product to stand, whereas in a bag, there is no base and they will only stand if the content is able to stand on its own.</p>
<p>Bag-in-Box</p>		<p>Common packaging type within the foodservice sector that is used mostly for liquids that are dispensed later as drinks, for instance. A bag-in-box exists as a single unit and the internal sack (which holds the actual liquid) cannot be separated from the external protective box without damaging the product.</p>
<p>Usage of “Not Packed” and “Packed, unspecified”</p>		<p>The code “Not packed” is utilised when a trade item contains no packaging at all (instances where the product itself requires no packaging form, for instance, a book).</p> <p>In contrast the code “Packed, unspecified” is to be used when the trade item does have a form of packaging type which cannot be defined by any of the codes currently in the list.</p> <p>Important: If the code “Packed, unspecified” is used, the implementer is expected to submit a change request to the GSMP for the addition of the appropriate type of packaging to the list. “Packed, unspecified” is therefore only meant to be used in a temporary basis while the appropriate codes are set up.</p>

Example	Illustration	Description
<p>Tray</p>		<p>This packaging type is used for all products that contain a tray at any level (base unit/pack/case/pallet). This code also covers all 'ready to cook' plates in which some products are sold and 'divider sheets/slip sheets' which are used to hold layers on a pallet.</p> <p>It includes plates, cardboard carriers, cell plates, divider sheets/slip sheets, plastic-wrapped trays, trays for bottles, trays one layer no cover, trays tablet, trays shrink-packed or trays pack.</p>

18.2.3.3 How to Provide Further Details about the Packaging?

Once the appropriate code to express the type of packaging of the trade item has been selected, further detail can be provided about the properties of the packaging.

The most important are:

Packaging functions: specified through the attribute "packagingFunctionCode", consist of a series of properties that the packaging is expected to contain and/or perform, such as:

- evidencing tampering attempts (Tamper evident)
- having specific protection and or treatments (Coated, Reinforced)
- providing usage functionality for the consumer (Dispenser)
- being able to maintain specific circumstances for the content (Antiseptic, Oxygen-infused).

- **Note:** Multiple functions can be selected from the list as combinations of functions are possible.

Packaging features: specified through the attribute "packagingFeatureCode", consist of a series of properties that the packaging may have as attachments, improvements and additions that assist in the usage and/or handling:

- a grip to help in the handling (Handle)
- specify the package has dividers to separate individual items for safe handling (Internal Dividers)
- certain attachments (Label, Tags, etc.)
- being able to maintain the packaging shape & content (Edge protection).

- **Note:** Multiple features can be selected from the list as combinations of features are possible.

Packaging shapes: specified through the attribute “packagingShapeCode”, allows communication of the shape or form of the packing:

- Cone, Rectangular, Cylindrical, Spherical are just a few.

- **Note:** Only a single shape can be selected.

Packaging Owner Name: describes potential branding of certain packaging like Tetra, CHEP, EPAL, etc.

Packing Material Types: See [GS1 standards website](#).

18.3 Code Lists Platform Type

The following section provides advice regarding the setup of platform information for a trade item. Platform information can come from the following articles:

- Pallet platforms that conform to industry standard sizes (e.g. ISO-pallets)
- Other means of transportation such as bulk containers and dollies.

18.3.1 Pre-Requisite

The data source must know the type of shipping platform/container that is used in the transportation of the trade item.

18.3.2 When Would I Use This?

Accurate information of the type of platform is essential to ensure a smooth and safe handling of a product throughout the supply chain. Trading partners have a constant need for reliable information regarding the platforms, cages, bulk containers and other means used for the transportation and storage of products across the supply chain.

Platform information for a trade item is set up as part of the trade item data that is communicated by trading partners.

Therefore, it can be assumed that when an organisation makes use of these attributes, it is because trading partners have agreed to synchronise packaging information through GDSN.

18.3.3 How to Express Platform Type Information?

The following section provides some recommendations for the communication of platform information. Platform information is determined by defining:

- The type of platform used
- Additional characteristics are expressed through other attributes.
 - Dimensions
 - Features
 - Function
 - Returnable Asset Information
 - If branded platforms like EPAL, CHEP use packagingOwnerName
- The material of which the platform is made (for communication of materials please refer to section [18.4](#)).

18.3.3.1 How to Select the Appropriate Platform Type Code



The type of platform that is used in a trade item can be specified through the use of the **platformTypeCode** attribute. This attribute is populated with a code from the platform type list.

Trading partners that make use of a standardised platform type can easily choose the right platform type from the list as all the codes have a definition which includes the dimensions for the platform.

- **Important:** In case of the platform type does not conform to the size of any of the identified standard platform types, the code 50 "Custom Platform" should be used. There is a new class of attributes that allow the population of width and depth. The height is made optional for platforms only.
- **Important:** The actual dimensions of the full pallet/platform with the trade items on it would be communicated via Trade Item Measurements Module. Only the packaging and pallet/platform dimensions are populated in the dimension class in Packaging Information Module.
- **Important:** The usage of "Custom Platform" is not to be confused with that of the code "Unspecified" which is used to indicate that a trade item is palletised but the type of platform itself is not available. The measurements of the platform are therefore not provided when the platform type is set to "Unspecified" as they are not known.

The [GDSN code list definitions for PlatformTypeCode](#) can be found in the [GS1 Navigator, GDSN](#).

Examples of Platform Types

Example	Illustration	Description
Dolly		This term refers to all portable, wheeled platforms usually with a frame that are used either to transport, store or display items.
Reusable containers		A shipping and storage container that is designed for reuse without impairment of its protective function. It may be repaired, refitted, or both, to prolong its life or to adapt it for shipment of items other than that for which it was originally intended. Source: https://acc.dau.mil/CommunityBrowser.aspx?id=31275

18.3.4 Intermediate Bulk Containers

An Intermediate Bulk Container (IBC) derives its name from where it is used within the supply chain. The IBCs are primarily used to transport and store material that is used in an intermediate processing step prior to finished goods.

Many times these containers have fill and discharge openings to facilitate filling the container and removing its contents in smaller measured units as needed. IBC can have a removable / replaceable liner to accommodate different types of material from grain to liquids.

Within the IBC family there are two major categories: Flexible IBC (FIBC) and Rigid IBC (RIBC)

It is important to distinguish the two categories. When referring to the GS1 Package and Pallet-Platform types FIBCs are considered packaging types as they are not a platform and RIBCs are

considered a Pallet-Platform "IF" they have an integrated platform suitable for lifting by a fork lift or other jacking device.

The following are examples of FIBC



The following are examples of different Rigid Intermediate Bulk Containers that are platform Type Code. If the platform is NOT attached to the container, consider using the packaging Type Code of the same name.



18.4 Code Lists Packaging Material

Packaging material information is exchanged between trading partners to communicate the materials or combination of materials of which each part of the packaging or Platform/Pallet of a product is made.

Within GDSN a flexible and comprehensive model exists for the communication of packaging material information, therefore, all materials that are used in the packaging, along with their properties may be fully described.

18.4.1 Pre-Requisite

The data source must have access to corroborated factual information about which materials are used in the composition of the packaging/platform/pallet and the properties of said materials.

18.4.2 When Would I Use This?

Packaging material information for a trade item is set up as part of the trade item data that is communicated by trading partners.

Therefore, it can be assumed when an organisation makes use of these attributes, it is because trading partners have agreed to synchronise packaging information through GDSN.

- **Note:** This information is usually important to trading partners as it is used to calculate recycling fees/taxes that need to be paid in order to process and dispose of the materials of which the packaging is made once the later has been discarded. Given that different fees exist in all countries as well as different categorisations of the materials, the attributes used to pass this information can be used in multiple combinations in order to adapt to all possible scenarios.
- **Note:** Additionally basic sustainability for packaging can be supplied here. If there is a need to supply information concerning Sustainability to support Metrics, then refer to [Section 28: Packaging Sustainability](#).

18.4.3 How To Express the Materials Used in a Trade Item?

In order to communicate packaging material information, the following attributes are used:

- **packagingMaterialTypeCode:** it is used to communicate the type or types of materials of which the packaging Type is made. It can be repeated and specified for each material.
- **Note:** The packaging Material Type Code is related to the packaging type code. If there are multiple packaging types, each would have the associated packaging material information associated to it.

18.4.3.1 Identifying the Packaging Materials

In order to declare the materials of which the packaging trading partners must agree and consider which factors affect the material declaration such as:

- Usage of the packaging material information (recycle tax fee calculation, informative, etc.)
- Local recycling laws and material categories that are therein applied (e.g. EU Commission Directive 94/62 EC).
- If the proportion of a material is significant enough to be listed (according to local regulations)
- With these aspects in mind, trading partners can collect the required material data to enable them to determine how much detail is necessary to express the material characteristics.

Once the information provider has collected the required material information (data sheets, packaging providers, etc.) the corresponding attributes may be used as recommended below to provide detailed packaging material information.

18.4.3.2 Selecting the Appropriate Material Code

The first step is to determine for which packaging type you will gather information. Then for each packaging type you can obtain the packaging material information to set up the code(s) that express the basic material(s) of which the packaging is made. The codes for packaging material types are communicated through the attribute **packagingMaterialTypeCode**.

The packaging material type code list includes clear definitions for every type of material that is contained in the list. Even with the definitions, sometimes alternative names exist for a type of material. In order to provide some orientation about alternative names for codes in the list, [GS1 Navigator, GDSN](#) is offered as a reference.

The GDSN code list definitions for **PackagingMaterialTypeCode** can be found in the [GS1 Navigator, GDSN](#).

18.4.4 How to Provide Further Details about the Packaging Materials?

Additional attributes are available to express information about the packaging materials. For each packaging material type, you can specify additional information.

In addition there are complex packaging types where the actual materials cannot be separated from one another known as Composites. This scenario has some additional attribute population required.

The most important are:

Packaging Material Applied Process Code: The code of the processes applied to the material or used in the manufacturing of the material to modify/enhance its properties.

- Chemically Hardened
- Moisture Resistant, Water Repellent
- Moulded, Insulated, Vacuum packed, etc.

Packaging Material Composition Quantity: The quantity of the packaging material of the trade item. Can be weight, volume or surface, can vary by country. Allows for the representation of the same value in different units of measure.

18.4.4.1 How to specify details for material type of Composite, Laminated Carton, Paperboard or Other

If you are using one of the combination codes, you have the ability to specify the packaging material composition quantity or material thickness by each constituent.

Example:

Comments	Attribute	Value
The main packaging material is a combined paperboard and plastic which cannot be separated	packagingMaterialTypeCode	COMPOSITE
The weight of the combined material	packagingMaterialCompositionQuantity	10 GRM
This is how we specify the paperboard constituent	CompositeMaterialDetail/ packagingMaterialTypeCode	PAPER_PAPERBOARD
	CompositeMaterialDetail/ packagingMaterialCompositionQuantity	7 GRM
This is how we specify the plastic constituent	CompositeMaterialDetail/ packagingMaterialTypeCode	PLASTIC_OTHER

Comments	Attribute	Value
	CompositeMaterialDetail/ packagingMaterialCompositionQuantity	3 GRM

18.5 Packaging Example



Comments	Attribute	Value
The main packaging is the bottle	packagingTypeCode	BOTTLE
It has a label	packagingFeatureCode	LABEL
It has a cap	packagingFeatureCode	CAP
	packagingWeight	1.2 GRM
The bottle is made of multiple polymers	packagingMaterialTypeCode	POLYMER_HDPE
	packagingMaterialCompositionQuantity	1 GRM
	packagingMaterialTypeCode	POLYMER_PE
	packagingMaterialCompositionQuantity	0.2 GRM
Next is the blister protection	packagingTypeCode	BLISTER_PACK
	packagingWeight	0.5 GRM
	packagingMaterialTypeCode	POLYMER_LDPE
	packagingMaterialCompositionQuantity	0.5 GRM
Next is the card backing	packagingTypeCode	CM
	packagingWeight	0.4 GRM
	packagingMaterialTypeCode	PAPER_PAPERBOARD
	packagingMaterialCompositionQuantity	0.4 GRM

19 Min Max Values

When populating data where there is a Minimum and Maximum set of values, these attributes should be populated with the lower limit in the minimum and the upper limit in the maximum.

However, not all situations have a range for the information being requested. The table below gives guidance as best practice on how to populate.

Information Type Available	Populated In	Value
Range of Lowest to Highest	Minimum Values Field	Lowest Value
	Maximum Values Field	Highest Value
Less Than a Value	Minimum Values Field	Leave Null
	Maximum Values Field	Highest Value
Greater Than a Value	Minimum Values Field	Lowest Value
	Maximum Values Field	Leave Null
Single or Recommended Value	Minimum Values Field	Single Value populated in both fields
	Maximum Values Field	

19.1 Examples

A trade item has a storage weight range of 5 grams to 36 grams. Since there is a range, both Minimum and Maximum values would be populated and would be different.

Attribute	Value	UoM
variableWeightRangeMaximum	36	Grams
variableWeightRangeMinimum	5	LGrams

A trade item has an individual unit size of no more than 5 oz. Since the value is a less than value, only Maximum value would be populated.

Attribute	Value	UoM
individualUnitMaximum	5	oz
individualUnitMinimum		

A trade item has an order quantity of no less than 12. Since the value is a greater than value, only Minimum value would be populated.

Attribute	Value
orderQuantityMaximumSize	
orderQuantityMinimumSize	12

20 Relevant Product Hierarchy Levels & Common Values

This section provides advice on which levels of a typical product hierarchy are appropriate for each attribute, and whether the same value should be sent for every level in the product hierarchy.

- **Note:** This information was published in incomplete form as an Appendix to the BMS in early versions of the Trade Item standard. The GS1 GDSN Business Requirements Group (BRG) formally confirmed that this information is advisory, not normative, and ensured the information was completed for all attributes. Because it is classified as advisory, it is made available via this Implementation Guide, not as a formal part of the BMS.

20.1 Why Would I Use This?

Many optional attributes make business sense to be used only at some levels of the product hierarchy. For example:

- For an electrical product, it makes sense to provide **CumulativeEnergyDemand** at the **Each** level only. It does not need to be repeated for a Case.
- For any product, it makes sense to allow the Data Source to publish firstOrderDateTime at any level of the product hierarchy and the values might be different at each level. The published hierarchy might include an existing **Each** (already published in another hierarchy) contained in a new configuration of Case not made available before, where the Case has a different **firstOrderDateTime** from the Each.

20.2 Pre-Requisites

- The Data Source has analysed what data is to be published and has identified the attributes to be used. Its master data environment is capable of storing and making available for publication the relevant attributes at the appropriate levels of the product hierarchy.
- The Data Recipient has the capability to store different data at different levels of the product hierarchy. Its master data environment is capable of receiving, storing and using in its internal processes of the relevant attributes at the appropriate levels of the product hierarchy.

20.3 When Would I Use This?

When the Data Source has identified the information to be published, he should prepare a mapping from his internal database(s) to send the data to the Source Data Pool. When preparing the mapping, one key question is which attributes are relevant for each level of the product hierarchy.

The [Common Values Relevant Levels Spreadsheet](#) shows the detail, by attribute, of the advice based on many implementations in many countries:

- which levels of the product hierarchy may typically be relevant for the attribute
 - whether the data value for the attribute should be the same at all levels of the product hierarchy
 - comments e.g. to explain why some levels are relevant
- **Note:** The information is advisory. It is the responsibility and privilege of the Data Source to determine which data attributes will be published at which product hierarchy level. The XML Schema is capable of holding all attributes at all levels of the product hierarchy. Provided no formal [GDSN Validation Rules](#) are broken, the message should not be rejected on the basis of attributes being populated at a particular level.

20.4 Explanation of the Report Contents

Column	Column Name	Description
(1)	Extension Name /Fast Track	The list contains all available Trade Item attributes, including Core Trade Item, Fast Track, and Extension attributes. The list is sequenced by Class, within Extension.
(2)	Class Name	Note: The list is updated during the GDSN Maintenance Release process
(3)	Attribute Name	Fast Track attributes are included under Extension Name "Fast Track" and Class is left blank. Note: Fast Track attributes are communicated using the AVP Extension .

Column	Column Name	Description
(4)	Product Hierarchy Level	<p>The 'product hierarchy level' column advises which Trade Item Unit Descriptors are most commonly used for sending the attribute.</p> <p>'All' means that the attribute could be sent for any or all hierarchy levels.</p> <p>'Lowest level' means that the attribute is advised to be sent for the lowest hierarchy level only. Most commonly this is the "Base Unit or Each" level, but some hierarchies may use a different Trade Item Unit Descriptor at this level, such as "Case" for some FoodService trade items.</p> <p>'Non-lowest level' means that the attribute can be sent for any or all hierarchy levels except the lowest one. Typically it will not be sent for the lowest level.</p> <p>'Highest level' means that the attribute is advised to be sent for the highest hierarchy level only. Most commonly this is the "Pallet" level, but where no GTIN has been allocated to identify the logistics unit (e.g. pallet) as an item of trade, the product hierarchy will use a different Trade Item Unit Descriptor at this level, typically "Case".</p> <p>'Non-pallet level' means that the attribute typically will not be sent for the "Pallet" level, but it can be sent for any or all other hierarchy levels. If no "Pallet" level is sent, then the attribute can be sent for any or all levels.</p> <p>The comment 'Typically applicable to a consumer unit' has been added for some attributes which might normally be expected to be sent for the lowest hierarchy level only. In a simple product hierarchy such as "Pallet – Case – Each" where only the Each is intended for sale at a Retail Point-of-sale, these attributes would typically be sent only at the lowest level.</p> <p>However some other products are designed and intended to be sold to consumers at more than one level. For example, a drinks manufacturer may make a product available as a single bottle, a 6-pack of the bottles and a case of four 6-packs, all designed for sale at the Retail Point-of-sale. In the product hierarchy the attribute <i>isTradeItemAConsumerUnit</i> is set to TRUE for the Each, the Pack, and the Case. In this example, the attributes marked 'Typically applicable to a consumer unit' may be expected to be sent for the Each, the Pack and the Case.</p> <p>Note: For more information on Product Hierarchy Reference Levels, refer to section 4, Trade Item Unit Descriptors (Building Trade Item Hierarchy) for the complete list...</p>
(5)	Common Value Indicator	<p>The 'common attribute value' condition indicates whether the value for the attribute is advised to be the same value in all levels of a given hierarchy. This feature is optional to support for the data pools and trading partners but helps them to achieve consistent data handling in the hierarchy.</p> <p>Common Value Indicator = NO:</p> <p>Meaning: The attribute value is not common to all levels of the trade item hierarchy</p> <p>Example: grossWeight is not common to all levels of the trade item hierarchy, so the value can be different on the different hierarchy levels e.g.</p> <p>grossWeight of Each = 10 lbs / 4,5 kg grossWeight of Pallet = 100 lbs / 45 kg).</p> <p>Common Value Indicator = YES:</p> <p>Meaning: The attribute value is common to all levels of trade item hierarchy</p> <p>Example: shipFromLocationIdentification is common to all levels of the trade item hierarchy, so this value should be the same for each hierarchy level e.g.</p> <p>shipFromLocationIdentification = '1234567890128' for all levels published in the trade item hierarchy</p> <p>Note: The comment 'To allow for assortments' has been added for some attributes which might normally be expected to have the same value at all levels. Some assortment items might require different values for each hierarchy level.</p> <p>For example: a manufacturer offers a Trade Item which is a Case of jam, with different flavours available at the Each level:</p> <ul style="list-style-type: none"> - 4 x Strawberry - 4 x Raspberry - 4 x Blackcurrant <p>If the manufacturer is using the Variant attribute to hold the flavour, the Each trade items will have the respective flavour in Variant, and the Case trade item may have a Variant of "Mixed" or "Strawberry,Raspberry,Blackcurrant".</p>

Column	Column Name	Description
(6)	Comments	Additional information helpful for implementation. For example an additional comment may explain why the attribute might apply to more than one level of a trade item hierarchy, or to give examples.

20.5 Implementation Considerations

Supporting the functionality:

- This rule could be an additional validation for the GDSN data pools.
- Data pools MAY validate the master data of their data sources against this rule but CAN NOT enforce this validation on the data sources of other data pools (incoming CINS).
- Special rule for mixed hierarchies: the validation of 'common' condition CAN be ignored in case of parents with mixed children (and above that level) as they are implicitly not common at all levels of that hierarchy.

20.6 Standards Maintenance Considerations

The GDSN Maintenance Release process will take into account these considerations before assigning the appropriate 'Product Hierarchy Level' and 'Common Value Indicator' condition to a new attribute:

- Can the attribute be used in more than one hierarchy level?
- Will the supplier (manufacturer) provide the same value for every levels of the trade item hierarchy?
- Will a distributor or importer provide the same value for every levels of the trade item hierarchy (example different trade items from different suppliers in the same case)?
- If the answer is 'true' for every question above then the attribute can have its Common Value Indicator set to '**Yes**'.

For each successive GDSN Release, the GS1 development team provides a list of suggested values for any new attributes in the release to the GDSN Trade Item Implementation Guide team – who will review the suggested values, amend where necessary, and when satisfied the revised values will be submitted for Public Review. Once any comments arising from Public Review are resolved, a new issue of the advice will be published.

21 Order Sizing Factor

This section defines and describes Order Sizing Factor and addresses how to implement it in the GS1 Global Data Synchronisation Network (GDSN).

Order Sizing Factor addresses:

- **Scenario 1:** When there is a mix of product where neither weight (gross or net) nor cube alone can be used to calculate how much product can be ordered to optimise the amount of product within a truckload, and thereby minimise transportation charges.
- **Scenario 2:** It may also be used to define price discount ranges or conditions of delivery.

Normally it is applied to orderable items

21.1 Pre-Requisites

- The supplier is responsible for creating a methodology for the calculation of Order Sizing Factor, for calculating the Order Sizing Factor values, and for communicating how OSF should be used by the buyer.
- The supplier is also responsible for communicating to the buying function that an order sizing factor is available along with the benefits of its use.

21.2 Scenario 1: Truckload Sizing

An example of this might be where a load has a mix of detergent and paper towels. Using the weight of the product to calculate truckload would more than cube out the truck.

21.2.1 Example 1: Similar Small Cases

A buyer interested in purchasing the product pictured below together with other products with relatively small cases might mistakenly think that an additional layer of product should be ordered to fill the truck to the ceiling. A buying system using true cube (multiplying each dimension of the case and then multiplying by the number of cases) will not appropriately account for:

1. The space between the edge of the cases (35" by 44.375") and the edge of the pallet (40" by 48")
2. The space between the top of the product stack and the ceiling of the truck.

Order Sizing Factor can eliminate these shortcomings.

Figure 21-1 Order Sizing Factor Example

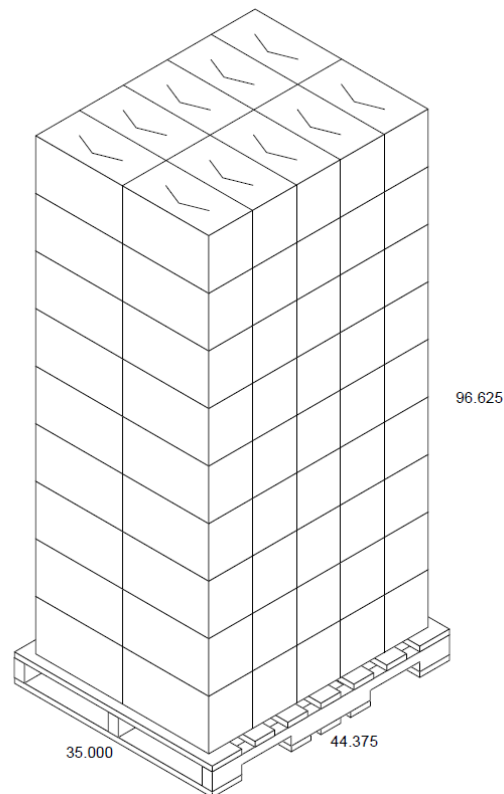

21.2.2 Example 2: Mixed Product Densities

There are situations where a variety of products are being ordered for delivery together where this is a wide variation in either weight or cube. Using weight alone to determine a full truckload would result in over cubing the truck. Using cube alone would create truckloads that weigh too much. Using an algorithm that builds a truck until either one of the two parameters (weight or cube were exceeded) would likely result in lighter product being loaded on top of very heavy product. This is not acceptable because it adds weight on top of a stack of heavy product. The order multiple established for the heavy product will have been designed to support its own weight. Adding a different product on top may well exceed the weight tolerance for the lowest layer of product thereby damaging the product. Quite often the buyer only has one parameter to control when an order constitutes a "full truck", Order Sizing Factor can fulfil this need.

An order for a mixed truckload of dry cereal combined with canned soup might be a useful example to think of. Dense products like meat, canned goods, and liquids will "weigh out" the truck first, before the truck would "cube out." Low density products like cereal or finished baked goods will "cube out" a truck first.

- **Note:** It is not uncommon for certain groups of products to be ordered by different ordering parameters from the same supplier. For example:
 - Food products could be ordered by the gross weight, while Health and Beauty Care (HBC) items are ordered using the Order Sizing Factor
 - In this example, Food and HBC would ship on separate orders (truck, rail, etc.).
 - Some well-established synonyms for Order Sizing Factor include COF (Cube Order Factor), CAW (Cube Adjusted Weight), or Loading Equivalent (LEQ).

21.2.3 When Would I Use This?

Whenever a single shipping configuration is offered by the supplier and used by the buyer, Order Sizing Factor can be published and used at the case level of the product hierarchy.

However, when Order Sizing Factor is published at the shipping configuration level of the product hierarchy, this value should supersede the order sizing factor provided at the case level (if any).

- **Note:** Whenever the Order Sizing Factor is published at the shipping configuration level, it is important that the receiver of this information use this value rather than what is found at the case level of the product hierarchy. In this situation, the value published at the shipping configuration level will be different and significantly more accurate for the buyer than what is at the case level. This is because Order Sizing Factor is directly affected by the shipping configuration used by the buyer and seller.

21.3 Scenario 2: Pricing & Transport Optimisation

An alternative use of Order Sizing Factor is based on a “points” scheme, determined by the supplier. These points are then used for price brackets or conditions of delivery that will apply to the related trade item. The points are awarded on a “per GTIN” basis, calculated from the quantity of that GTIN ordered by the customer, and applied to the order line item or to the order as a whole by the supplier.

21.3.1 Example 1: Chocolate Bar 50grs x 6

- **Each** – price varies according to bands of “points”
 - €1.857 (<1,000 points)
 - €1.796 (1,000 to 2,999 points)
 - €1.771 (3,000 to 4,999 points)
 - €1.760 (5,000 to 6,999 points)
 - €1.752 (7,000 to 12,999 points)
 - €1.748 (13,000 points or more)
 - €1.733 (price for optimised truckload, regardless of number of points)

- **Case** – 1 carton ordered = 15 points for every case ordered

The only information to be sent in Item Sync is that the Order Sizing Factor for the Case is “15 points”.

The seller will separately inform the buyer of the prices applying to each band of points, and also the price for the optimised truckload. For example, this may be done using GDSN Price Sync, or in some way outside of the Network.

The buyer will later place a purchase order for the Chocolate Bars. On receipt of the purchase order, the seller will calculate the total number of points “earned” by the buyer for the Trade Item and apply the corresponding price.

21.3.2 Example 2: Bathroom Sponge

- 2 points per sponge
- 1000 points earns free delivery on the whole order

The only information to be sent in Item Sync is that the Order Sizing Factor for the Each is “2 points”.

The seller will separately inform the buyer of the delivery price condition applying to orders with more than 1000 points. For example, this may be done using GDSN Price Sync, or in some way outside of the Network.

The buyer will later place a purchase order for the Bathroom Sponges. On receipt of the purchase order, the seller will calculate the total number of points “earned” by the buyer for the Trade Items on the order and apply the corresponding delivery price condition.

21.3.3 When Would I Use This?

Whenever the supplier offers additional pricing options based on the quantities ordered, with different weighting (“points”) for each orderable Trade Item, and knowledge of the weighting (“points”) available can be used by the buyer to optimise orders, Order Sizing Factor can be published and used at the orderable level(s) of the product hierarchy.

22 Tax, Duties & Fees Information

A common requirement for retailers is to know the tax applicable to selling a trade item. The item’s manufacturer normally knows this information, at least at a national level, and sometimes at a more local level.

GDSN standards support several scenarios for passing this information. This section illustrates the possibilities with examples.

22.1 Pre-Requisite

Since the use of tax codes is managed by local code lists, the examples used in the Implementation Guide is fictitious data. Users are advised to contact their data pool and/or local GS1 MO for further information on how the tax attributes are used in particular countries.

22.2 When Would I Use This?

When a trade item is subject to tax, levy, or charge and when the data source is able to communicate how the trade item is classified for those purposes, then the data recipient can be advised of the tax classification, rate, amount or applicability to ensure accurate application of taxes when the item is sold, transported or disposed of further down the supply chain.

- **Important:** If you need to specify a tax rate for a different Target Market, then you must publish that Target Market with the proper tax rate. You can not specify a different Target Market. For example if I publish an item to the Netherlands, I cannot send the tax rates for Belgium in the Netherlands trade item.
- **Important:** If you need to specify a tax rate for a sub-region of a target market, this is not possible today other than publishing an item to a sub-region. This could be a potential enhancement in the future.

22.3 How to communicate Trade item Tax Information

Within the Duty Fee Tax Information Module, the tax subclasses have the ability to be repeated to represent multiple types of tax rates, amounts, charges, or tax information.

22.3.1 What Information can be communicated?

There are different kinds of tax information:

Mandatory attributes that needs to be populated.

- Duty Fee Tax Agency responsible for the Tax, Fee or Duty
- Duty Fee Tax type code which describes the type of Tax referenced (e.g. VAT)

Optional attributes

- Whether tax is applicable can be expressed as a code (e.g. APPLICABLE, EXEMPT, etc.)
 - Duty Fee Tax Category Code
- The tax rate, expressed as a percentage (e.g. 5%)
 - Duty Fee Tax Rate
- The tax amount, expressed as a currency amount (e.g. €10.00)
 - Duty Fee Tax Amount
- The tax exempt party role that is exempt from a tax (e.g. Consumer)
 - Duty Fee Tax Exempt Party Role Code
- The tax levy basis on which the taxation is based upon (e.g. 3 grams)
 - Duty Fee Tax Basis
- Tax effective start and end date if applicable for a tax that may be upcoming, eliminated, modified, etc.
 - Duty Fee Tax Effective Start Date Time
 - Duty Fee Tax Effective End Date Time
- Tax reduction criteria if a supplier under certain conditions may have a reduced tax
 - Duty Fee Tax Reduction Criteria Description
- **Note:** Only the Duty Fee Tax Agency and the Duty Fee Tax Type Code are mandatory; all other attributes are optional.
- **Note:** A Trade Item might be subject to more than one Tax. For instance, it might be subject to a Sales Tax (as a percentage) and to a Waste Disposal Charge (as a fixed currency amount). This is possible, provided that all the relevant attributes are supplied for each Tax in turn.

22.3.2 Examples

- **Note:** The data used in these examples is fictitious and should not be used as real data.
- **Important:** Before implementing GDSN Tax information, it is essential to check with your GDSN Data Pool or local GS1 Member Organisation, to obtain the latest information on values acceptable in your trading sector.

Additionally check the GS1 website as GS1 Member Organisations have the ability to upload their [Local Code Lists](#).

22.3.2.1 Example 1: Tax Rate

Communicate only a VAT rate of 17.5%

Attribute	Value	Comments
Duty Fee Tax Agency Code	ABC	The XX authority for VAT
Duty Fee Tax Type Code	VAT	Local Code list code
Duty Fee Tax Agency Name	XX Authority	(O) Up to 200 characters
Duty Fee Tax Country Code		(O) Not sent Usually only sent if different then Target Market
Duty Fee Tax Effective End Date Time		Not sent
Duty Fee Tax Effective Start Date Time		Not sent
Is Trade Item a Combination Item		Not sent
Duty Fee Tax Classification Code		Not sent
Duty Fee Tax Type Description	Value Added Tax	Up to 70 characters
Duty Fee Tax Amount		Tax Amount is not sent
Duty Fee Tax Category Code		Not sent (Old Applicability Code)
Duty Fee Tax Basis		Not sent
Duty Fee Tax Country Subdivision Code		Not sent
Duty Fee Tax Exempt Party Role Code		Not sent
Duty Fee Tax Rate	17.5	Tax Rate is sent
Duty Fee Tax Reduction Criteria Description		Not sent

22.3.2.2 Example 2: Tax Amount

Communicate the Waste Disposal Charge of 1.50€

Attribute	Value	Comments
Duty Fee Tax Agency Code	XYZ	Environmental Entity in XX
Duty Fee Tax Type Code	WST	Local Code list code
Duty Fee Tax Agency Name		(O) Up to 200 characters
Duty Fee Tax Country Code		(O) Not sent Usually only sent if different then Target Market
Duty Fee Tax Effective End Date Time		Not sent
Duty Fee Tax Effective Start Date Time		Not sent
Is Trade Item a Combination Item		Not sent
Duty Fee Tax Classification Code		Not sent
Duty Fee Tax Type Description	Waste Disposal Charge	Up to 70 characters
Duty Fee Tax Amount	1 .50 €	Tax Amount is sent
Duty Fee Tax Category Code		Not sent (Old Applicability Code)
Duty Fee Tax Basis		Not sent
Duty Fee Tax Country Subdivision Code		Not sent
Duty Fee Tax Exempt Party Role Code		Not sent
Duty Fee Tax Rate		Tax Rate is not sent
Duty Fee Tax Reduction Criteria Description		Not sent

22.3.2.3 Example 3: Implied Tax Rate

Communicate the Tax code that has implied Tax Rate

Attribute	Value	Comments
Duty Fee Tax Agency Code	ABC	The XX authority for Taxes
Duty Fee Tax Type Code	VAT_REDUCE	Local Code list code
Duty Fee Tax Agency Name		(O) Up to 200 characters
Duty Fee Tax Country Code		(O) Not sent Usually only sent if different then Target Market
Duty Fee Tax Effective End Date Time		Not sent
Duty Fee Tax Effective Start Date Time		Not sent
Is Trade Item a Combination Item		Not sent
Duty Fee Tax Classification Code		Not sent
Duty Fee Tax Type Description	Reduced tax Rate 17.5	Up to 70 characters
Duty Fee Tax Amount		Tax Amount is not sent
Duty Fee Tax Category Code		Not sent (Old Applicability Code)
Duty Fee Tax Basis		Not sent
Duty Fee Tax Country Subdivision Code		Not sent
Duty Fee Tax Exempt Party Role Code		Not sent
Duty Fee Tax Rate		Tax Rate is not sent
Duty Fee Tax Reduction Criteria Description		Not sent

22.3.2.4 Example 4: Tax amount using Levy Basis

Communicate a tax amount with Levy Basis Where the charge per WEEE is 1, 50€ and there are 2 sources of electrical components contained

Attribute	Value	Comments
Duty Fee Tax Agency Code	XYZ	Environmental Entity in XX
Duty Fee Tax Type Code	WEEE	Local Code list code
Duty Fee Tax Agency Name		(O) Up to 200 characters
Duty Fee Tax Country Code		(O) Not sent Usually only sent if different then Target Market
Duty Fee Tax Effective End Date Time		Not sent
Duty Fee Tax Effective Start Date Time		Not sent
Is Trade Item a Combination Item		Not sent
Duty Fee Tax Classification Code		Not sent
Duty Fee Tax Type Description	WEEE Charge	Up to 70 characters
Duty Fee Tax Amount	3.00 €	Tax Amount is sent
Duty Fee Tax Category Code		Not sent (Old Applicability Code)
Duty Fee Tax Basis	.002 MP	Item has .002 Metric tons of WEEE applicability
Duty Fee Tax Country Subdivision Code		Not sent
Duty Fee Tax Exempt Party Role Code		Not sent
Duty Fee Tax Rate		Tax Rate is not sent
Duty Fee Tax Reduction Criteria Description		Not sent

22.3.2.5 Example 5: Applicability Code Used

Communicate a tax applicability code where the tax rate is the High applicability within a target market

Attribute	Value	Comments
Duty Fee Tax Agency Code	ABC	The XX authority for Taxes
Duty Fee Tax Type Code	VAT	Local Code list code
Duty Fee Tax Agency Name		(O) Up to 200 characters
Duty Fee Tax Country Code		(O) Not sent Usually only sent if different then Target Market
Duty Fee Tax Effective End Date Time		Not sent
Duty Fee Tax Effective Start Date Time		Not sent
Is Trade Item a Combination Item		Not sent
Duty Fee Tax Classification Code		Not sent
Duty Fee Tax Type Description	VAT Charge	Up to 70 characters
Duty Fee Tax Amount		Tax Amount is not sent
Duty Fee Tax Category Code	HIGH	Sent (Old Applicability Code)
Duty Fee Tax Basis		Not sent
Duty Fee Tax Country Subdivision Code		Not sent
Duty Fee Tax Exempt Party Role Code		Not sent
Duty Fee Tax Rate	21.0	Tax Rate is sent
Duty Fee Tax Reduction Criteria Description		Not sent

22.3.2.6 Example 6: Zero Tax Rate plus Applicability

Communicate a tax applicability with a zero tax rate

Attribute	Value	Comments
Duty Fee Tax Agency Code	ABC	The XX authority for Taxes
Duty Fee Tax Type Code	Z	Local Code list code
Duty Fee Tax Agency Name		(O) Up to 200 characters
Duty Fee Tax Country Code		(O) Not sent Usually only sent if different then Target Market
Duty Fee Tax Effective End Date Time		Not sent
Duty Fee Tax Effective Start Date Time		Not sent
Is Trade Item a Combination Item		Not sent
Duty Fee Tax Classification Code		Not sent
Duty Fee Tax Type Description	Zero Rated	Up to 70 characters
Duty Fee Tax Amount		Tax Amount is not sent
Duty Fee Tax Category Code	ZERO	Sent (Old Applicability Code)
Duty Fee Tax Basis		Not sent
Duty Fee Tax Country Subdivision Code		Not sent
Duty Fee Tax Exempt Party Role Code		Not sent
Duty Fee Tax Rate	0	Tax Rate is sent
Duty Fee Tax Reduction Criteria Description		Not sent

22.3.2.7 Example 7: Expire one Tax rate and introduce another

Communicate the end of a tax rate end of year 2011 and a new tax rate beginning the New Year

First Repetition of Tax Information:

Attribute	Value	Comments
Duty Fee Tax Agency Code	ABC	The XX authority for Taxes
Duty Fee Tax Type Code	VAT	Local Code list code
Duty Fee Tax Agency Name		(O) Up to 200 characters
Duty Fee Tax Country Code		(O) Not sent Usually only sent if different then Target Market
Duty Fee Tax Effective End Date Time	2011-12-31T23:59:59	End of year
Duty Fee Tax Effective Start Date Time		Not sent
Is Trade Item a Combination Item		Not sent
Duty Fee Tax Classification Code		Not sent
Duty Fee Tax Type Description	Value Added Tax	Up to 70 characters
Duty Fee Tax Amount		Tax Amount is not sent
Duty Fee Tax Category Code		Sent (Old Applicability Code)
Duty Fee Tax Basis		Not sent
Duty Fee Tax Country Subdivision Code		Not sent
Duty Fee Tax Exempt Party Role Code		Not sent
Duty Fee Tax Rate	17.5	Tax Rate is sent
Duty Fee Tax Reduction Criteria Description		Not sent
Duty Fee Tax Agency Code	ABC	The XX authority for Taxes
Duty Fee Tax Type Code	VAT	Local Code list code
Duty Fee Tax Agency Name		(O) Up to 200 characters
Duty Fee Tax Country Code		(O) Not sent Usually only sent if different then Target Market
Duty Fee Tax Effective End Date Time	2012-01-01T00:00:00	Beginning of New Year
Duty Fee Tax Effective Start Date Time		Not sent
Is Trade Item a Combination Item		Not sent
Duty Fee Tax Classification Code		Not sent
Duty Fee Tax Type Description	Value Added Tax	Up to 70 characters
Duty Fee Tax Amount		Tax Amount is not sent
Duty Fee Tax Category Code		Sent (Old Applicability Code)
Duty Fee Tax Basis		Not sent
Duty Fee Tax Country Subdivision Code		Not sent
Duty Fee Tax Exempt Party Role Code		Not sent
Duty Fee Tax Rate	18.5	Tax Rate is sent
Duty Fee Tax Reduction Criteria Description		Not sent

22.3.2.8 Example 8: Levy Amount, Tax Rate on Levy, and Tax Rate

Communicate a WEEE Levy charge and the WEEE charge has a VAT tax and the Item has a VAT Tax implied

First Repetition of Tax Information:

Attribute	Value	Comments
Duty Fee Tax Agency Code	XYZ	Environmental Entity in XX
Duty Fee Tax Type Code	WEEE_LEVY	Local Code list code
Duty Fee Tax Agency Name		(O) Up to 200 characters
Duty Fee Tax Country Code		(O) Not sent Usually only sent if different then Target Market
Duty Fee Tax Effective End Date Time		Beginning of New Year
Duty Fee Tax Effective Start Date Time		Not sent
Is Trade Item a Combination Item		Not sent
Duty Fee Tax Classification Code		Not sent
Duty Fee Tax Type Description	WEEE levy charge	Up to 70 characters
Duty Fee Tax Amount	5.00 €	Tax Amount is sent
Duty Fee Tax Category Code		Sent (Old Applicability Code)
Duty Fee Tax Basis		Not sent
Duty Fee Tax Country Subdivision Code		Not sent
Duty Fee Tax Exempt Party Role Code		Not sent
Duty Fee Tax Rate		Tax Rate is not sent
Duty Fee Tax Reduction Criteria Description		Not sent

Second Repetition of Tax Information:

Attribute	Value	Comments
Duty Fee Tax Agency Code	ABC	The XX authority for Taxes
Duty Fee Tax Type Code	VAT_ON_WEEE	Local Code list code
Duty Fee Tax Agency Name		(O) Up to 200 characters
Duty Fee Tax Country Code		(O) Not sent Usually only sent if different then Target Market
Duty Fee Tax Effective End Date Time		Beginning of New Year
Duty Fee Tax Effective Start Date Time		Not sent
Is Trade Item a Combination Item		Not sent
Duty Fee Tax Classification Code		Not sent
Duty Fee Tax Type Description	VAT on WEEE Levy	Up to 70 characters
Duty Fee Tax Amount		Tax Amount is not sent
Duty Fee Tax Category Code		Sent (Old Applicability Code)
Duty Fee Tax Basis		Not sent
Duty Fee Tax Country Subdivision Code		Not sent
Duty Fee Tax Exempt Party Role Code		Not sent
Duty Fee Tax Rate	17.5	Tax Rate is sent
Duty Fee Tax Reduction Criteria Description		Not sent

Third Repetition of Tax Information:

Attribute	Value	Comments
Duty Fee Tax Agency Code	ABC	The XX authority for Taxes
Duty Fee Tax Type Code	VAT_STD	Local Code list code
Duty Fee Tax Agency Name		(O) Up to 200 characters
Duty Fee Tax Country Code		(O) Not sent Usually only sent if different then Target Market
Duty Fee Tax Effective End Date Time		Beginning of New Year
Duty Fee Tax Effective Start Date Time		Not sent
Is Trade Item a Combination Item		Not sent
Duty Fee Tax Classification Code		Not sent
Duty Fee Tax Type Description	Value Added Tax 21.0%	Up to 70 characters
Duty Fee Tax Amount		Tax Amount is not sent
Duty Fee Tax Category Code		Sent (Old Applicability Code)
Duty Fee Tax Basis		Not sent
Duty Fee Tax Country Subdivision Code		Not sent
Duty Fee Tax Exempt Party Role Code		Not sent
Duty Fee Tax Rate		Tax Rate is sent
Duty Fee Tax Reduction Criteria Description		Not sent

22.3.2.9 Example 9: Tax Type Code Goods and Services Tax with a Federal Tax Agency

Goods and Services Tax applied at the Point-of-sale taxes to meet Canadian business regulatory requirements

Attribute	Value	Comments
Duty Fee Tax Agency Code	CRA	The authority for taxes at the Federal level is Canadian Revenue Agency
Duty Fee Tax Type Code	GST	Local Code list code
Duty Fee Tax Agency Name	Canadian Revenue Agency	(O) Up to 200 characters
Duty Fee Tax Country Code	CA	(O) Not sent Usually only sent if different then Target Market
Duty Fee Tax Effective End Date Time		Not sent
Duty Fee Tax Effective Start Date Time		Not sent
Is Trade Item a Combination Item		Not sent
Duty Fee Tax Classification Code		Not sent
Duty Fee Tax Type Description	Goods and Services Tax	Up to 70 characters
Duty Fee Tax Amount		Not sent
Duty Fee Tax Category Code	Applicable	This is the Applicability Code <u>Select one:</u> - Applicable - Not Applicable - Exempt
Duty Fee Tax Basis		Not sent
Duty Fee Tax Country Subdivision Code		Not required

Attribute	Value	Comments
Duty Fee Tax Exempt Party Role Code		Not sent
Duty Fee Tax Rate		Not sent
Duty Fee Tax Reduction Criteria Description		Not sent

22.3.2.10 Example 10: Tax Type Code Harmonised Sales Tax with a Federal Tax Agency

Harmonised Sales Tax applied at the Point-of-sale taxes to meet Canadian business regulatory requirements

Attribute	Value	Comments
Duty Fee Tax Agency Code	CRA	The authority for taxes at the Federal level is Canadian Revenue Agency
Duty Fee Tax Type Code	HST	Local Code list code
Duty Fee Tax Agency Name	Canadian Revenue Agency	(O) Up to 200 characters
Duty Fee Tax Country Code		(O) Not sent Usually only sent if different then Target Market
Duty Fee Tax Effective End Date Time		Not sent
Duty Fee Tax Effective Start Date Time		Not sent
Is Trade Item a Combination Item		Not sent
Duty Fee Tax Classification Code		Not sent
Duty Fee Tax Type Description	Harmonised Sales Tax	Up to 70 characters
Duty Fee Tax Amount		Not sent
Duty Fee Tax Category Code	Applicable	This is the Applicability Code <u>Select one:</u> - Applicable - Not Applicable - Exempt
Duty Fee Tax Basis		Not sent
Duty Fee Tax Country Subdivision Code		Not Required
Duty Fee Tax Exempt Party Role Code		Not sent
Duty Fee Tax Rate		Not sent
Duty Fee Tax Reduction Criteria Description		Not sent

22.3.2.11 Example 11: Tax Type Code Provincial Sales Tax (PST) with a Provincial Tax Agency for 4 Provinces

Provincial Sales Tax applied at the Point-of-sale taxes to meet Canadian business regulatory requirements

Attribute	Value	Comments
Duty Fee Tax Agency Code	BC	
Duty Fee Tax Type Code	PST	Local Code list code
Duty Fee Tax Agency Name	British Columbia Ministry of Finance – Revenue Division (BC)	<i>The authority for taxes at Provincial level.</i> The agency responsible for the Provincial Sales Tax Collection Repeats for Each Canadian Province where PST is applicable.
Duty Fee Tax Country Code		

Attribute	Value	Comments
Duty Fee Tax Effective End Date Time		Not sent
Duty Fee Tax Effective Start Date Time		Not sent
Is Trade Item a Combination Item		Not sent
Duty Fee Tax Classification Code		Not sent
Duty Fee Tax Type Description	Provincial Sales Tax	Up to 70 characters
Duty Fee Tax Amount		Not sent
Duty Fee Tax Category Code	Not Applicable	This is the Applicability Code <u>Select one:</u> - Applicable - Not Applicable - Exempt
Duty Fee Tax Basis		Not sent
Duty Fee Tax Country Subdivision Code		Not required
Duty Fee Tax Exempt Party Role Code		Not sent
Duty Fee Tax Rate		Not sent
Duty Fee Tax Reduction Criteria Description		Not sent
Duty Fee Tax Agency Code	MB	
Duty Fee Tax Type Code	PST	Local Code list code
Duty Fee Tax Agency Name	Manitoba Finance Taxation Division (MB)	<i>The authority for taxes at Provincial level.</i> The agency responsible for the Provincial Sales Tax Collection Repeats for Each Canadian Province where PST is applicable.
Duty Fee Tax Country Code		
Duty Fee Tax Effective End Date Time		Not sent
Duty Fee Tax Effective Start Date Time		Not sent
Is Trade Item a Combination Item		Not sent
Duty Fee Tax Classification Code		Not sent
Duty Fee Tax Type Description	Provincial Sales Tax	Up to 70 characters
Duty Fee Tax Amount		Not sent
Duty Fee Tax Category Code	Applicable	This is the Applicability Code <u>Select one:</u> - Applicable - Not Applicable - Exempt
Duty Fee Tax Basis		Not sent
Duty Fee Tax Country Subdivision Code		Not required
Duty Fee Tax Exempt Party Role Code		Not sent
Duty Fee Tax Rate		Not sent
Duty Fee Tax Reduction Criteria Description		Not sent
Duty Fee Tax Agency Code	QC	
Duty Fee Tax Type Code	PST	Local Code list code

Attribute	Value	Comments
Duty Fee Tax Agency Name	Revenue Quebec (QC)	<i>The authority for taxes at Provincial level.</i> The agency responsible for the Provincial Sales Tax Collection Repeats for Each Canadian Province where PST is applicable.
Duty Fee Tax Country Code		
Duty Fee Tax Effective End Date Time		Not sent
Duty Fee Tax Effective Start Date Time		Not sent
Is Trade Item a Combination Item		Not sent
Duty Fee Tax Classification Code		Not sent
Duty Fee Tax Type Description	Provincial Sales Tax	Up to 70 characters
Duty Fee Tax Amount		Not sent
Duty Fee Tax Category Code	Applicable	This is the Applicability Code <u>Select one:</u> - Applicable - Not Applicable - Exempt
Duty Fee Tax Basis		Not sent
Duty Fee Tax Country Subdivision Code		Not required
Duty Fee Tax Exempt Party Role Code		Not sent
Duty Fee Tax Rate		Not sent
Duty Fee Tax Reduction Criteria Description		Not sent
Duty Fee Tax Agency Code	SK	
Duty Fee Tax Type Code	PST	Local Code list code
Duty Fee Tax Agency Name	Government of Saskatchewan (SK)	<i>The authority for taxes at Provincial level.</i> The agency responsible for the Provincial Sales Tax Collection Repeats for Each Canadian Province where PST is applicable.
Duty Fee Tax Country Code		
Duty Fee Tax Effective End Date Time		Not sent
Duty Fee Tax Effective Start Date Time		Not sent
Is Trade Item a Combination Item		Not sent
Duty Fee Tax Classification Code		Not sent
Duty Fee Tax Type Description	Provincial Sales Tax	Up to 70 characters
Duty Fee Tax Amount		Not sent
Duty Fee Tax Category Code	Applicable	This is the Applicability Code <u>Select one:</u> - Applicable - Not Applicable - Exempt
Duty Fee Tax Basis		Not sent
Duty Fee Tax Country Subdivision Code		Not required
Duty Fee Tax Exempt Party Role Code		Not sent
Duty Fee Tax Rate		Not sent
Duty Fee Tax Reduction Criteria Description		Not sent

22.4 Code Conventions for Tax Agency and Tax Type

GS1 has decided not to administer a global code list or standard for the attributes which identify a Tax:

- Duty Fee Tax Agency Code
- Duty Fee Tax Type Code

This is because the definition of taxes is constantly changing as governments and regulatory bodies at all levels frequently revise taxation.

- **Important:** Before implementing GDSN Tax information, it is essential to check with your GDSN Data Pool or local GS1 Member Organisation, to obtain the latest information on values acceptable in your trading sector.

Additionally check the GS1 website as GS1 Member Organisations have the ability to upload their [Local Code Lists](#).

22.5 Applicable Validation Rules for Tax

This section provided guidance for tax related [GDSN Validation Rules](#).

22.5.1 GDSN Validation Rule 528

For: Target Market 036 = Australia and dutyFeeTaxTypeCode is equal to 'WET' (Wine Equalisation Tax)

THEN: percentageOfAlcoholByVolume must be populated

22.5.2 GDSN Validation Rule 533

For: Target Market 528 = Netherlands

THEN: dutyFeeTaxCategoryCode must be populated

22.5.3 GDSN Validation Rule 571

For: Target Market 752 = Sweden

IF: dutyFeeTaxAgencyCode is populated

THEN: dutyFeeTaxAgencyCode must = 9SE

22.5.4 GDSN Validation Rule 578

For: Target Markets 056 = Belgium, 208 = Denmark, 246 = Finland, 276 = Germany, 356 = India
372 = Ireland, 380 = Italy, 442 = Luxembourg, 616 = Poland, 643 = Russia

AND: Excluding certain Healthcare trade items - GPC codes for 10005844 medical devices and 10005845 pharmaceutical drugs

EITHER: isTradeItemAConsumerUnit = TRUE

OR: isTradeItemAConsumerUnit = FALSE and TradeItemUnitDescriptorCode =
BASE_UNIT_OR_EACH

THEN: VAT Rate must be sent - the dutyFeeTaxTypeCode must include a value for a VAT tax

22.5.5 GDSN Validation Rule 603

For: Target Markets 250 = France, 249 = France

AND: tradeItemTradeChannelCode = 'GROCERY'

THEN: dutyFeeTaxAgencyCode must equal '65'

22.5.6 GDSN Validation Rule 618

For: Target Markets 250 = France

AND: gpcCategoryCode is in class '50202200' and does not = '10000142'

AND: isTradeItemAConsumerUnit = 'true'

THEN: at least one iteration of the dutyFeeTaxTypeCode must equal '3001000002008', '3001000002244', '3001000002312' or '3001000002329'

23 Dates

This section seeks to provide best practice guidance on the usage of the various date fields which exist in GDSN. When reviewing GDSN, there are a number of date fields which can be found. In most cases, the definition is good; however it is not complete enough to aid the typical user to understand the best use of the field. Additional guidance is presented here to help.

23.1 Pre-Requisite

This work has the pre-requisite that the user understands the choreography of GDSN, and the various trading partners therein engaged.

23.2 When Would I Use This?

This guide would be used anytime use of a date attribute is needed in GDSN.

23.3 Date Fields

- **Note:** For the technical definition (including ordinality and cardinality) please see [GS1 Navigator, GDSN](#)

Date Field	Attribute Name(s)
Audio Visual Media Date Time	audioVisualMediaDateTime
Availability Dates: Start & End	startAvailabilityDateTime endAvailabilityDateTime
Campaign Dates: Start & End	campaignStartDateTimecampaignEndDateTime
Cancel Date	cancelledDateTime
Certification Effective Date	certificationEffectiveStartDateTime certificationEffectiveEndDateTime
Change Date	lastChangeDateTime
Consumer Availability Date	consumerFirstAvailabilityDateTime
Community Visibility Date	communityVisibilityDateTime
Deposit Value Date	depositValueEffectiveDateTime depositValueEndDateTime
Discontinued Date	discontinuedDateTime
Effective Date	effectiveDateTime
Exclusivity Date	endDateTimeOfExclusivity
File Effective Date	fileEffectiveStartDateTime fileEffectiveEndDateTime

Date Field	Attribute Name(s)
Max Buying Quantity Date	startDateMaximumBuyingQuantity endDateMaximumBuyingQuantity
Min Buying Quantity Date	startDateMinimumBuyingQuantity endDateMinimumBuyingQuantity
Order Date	firstOrderDateTime lastOrderDateTime
Packaging Material Launch Date	packagingMaterialLaunchDateTime
Permit Date	permitStartDateTime permitEndDateTime
Price Effective Dates	priceEffectiveStartDatepriceEffectiveEndDate
Production Variant Effective Date	productionVariantEffectiveDate
Publication Date	publicationDateTime
Registration Date	registrationDateTime
Returnable Date	firstReturnableDateTimeTime lastReturnableDateTimeTime
Seasonal Availability Date	seasonalAvailabilityStartDateTime seasonalAvailabilityEndDateTime
Ship and Delivery Date	firstShipDateTime lastShipDateTime
Tax Type Effective Date	dutyFeeTaxEffectiveStartDateTimedutyFeeTaxEffectiveEndDateTime
Registration End Date Time	registrationEndDateTime
Regulated Chemical Sunset Date	regulatedChemicalSunsetDate
Content Date	contentDate
Contributor Date	contributorDate
(Books & Periodicals Publication) Date	(Books & Periodicals Publication) date

23.3.1 Audio Visual Media Date Time

audioVisualMediaDateTime

GDSN Section	AudioVisualMediaProductDescriptionInformationModule
Class Name	AudioVisualMediaDateInformation
Attribute Name	audioVisualMediaDateTime
Attribute Definition	The date for audio or visual media products for example release date.
Implementation Guidance	This attribute is used in conjunction with audioVisualMediaDateTypeCode to specify a variety of dates normally associated with audio visual media products, for example, FIRST_EDITION, LAST_MANUFACTURER_UPDATE, RENTAL_STREET, RERELEASE and THEATRICAL_RELEASE.

23.3.2 Availability Dates: Start & End

startAvailabilityDateTime

GDSN Section	Delivery Purchasing Information Module
Class Name	DeliveryPurchasingInformation
Attribute Name	startAvailabilityDateTime

Attribute Definition	The date (CCYY-MM-DDTHH:MM:SS) from which the trade item becomes available from the supplier; including seasonal or temporary trade item and services.
Implementation Guidance	Guidance will be provided once the GDS SMG Clarifies the use of this attribute.

endAvailabilityDateTime

GDSN Section	Delivery Purchasing Information Module
Class	DeliveryPurchasingInformation
Attribute	endAvailabilityDateTime
Attribute Definition	The date from which the trade item is no longer available from the information provider; including seasonal or temporary trade item and services.
Implementation Guidance	Guidance will be provided once the GDS SMG Clarifies the use of this attribute.

23.3.3 Campaign Dates: Start & End

campaignStartDateTime

GDSN Section	Marketing Information Module
Class Name	MarketingCampaign
Attribute Name	campaignStartDateTime
Attribute Definition	The date suggested by the supplier for the campaign to start. It indicates the beginning of a marketing campaign.
Implementation Guidance	A Campaign is a marketing event to promote the item. A campaign can be on going and as such dates might not be populated.

campaignEndDateTime

GDSN Section	Marketing Information Module
Class	MarketingCampaign
Attribute	campaignEndDateTime
Attribute Definition	The date suggested by the supplier for the campaign to end. It indicates the end of a marketing campaign.
Implementation Guidance	A Campaign is a marketing event to promote the item. A campaign can be on going and as such dates might not be populated.

23.3.4 Cancel Date

GDSN Section	Trade Item
Class Name	TradeItemSynchronisationDates
Attribute Name	cancelledDateTime
Attribute Definition	Date on which the cancellation of the launch of a trade item what was never and will never be manufactured is made.
Implementation Guidance	Cancel date is used for items which have never nor will ever be manufactured. The cancel date and the Discontinue date are mutually exclusive and cannot be populated on one GTIN simultaneously. The date can be set to one day in the past, but no farther in the past. This is to allow for the time zone changes around the world.

23.3.5 Certification Effective Date

certificationEffectiveStartDateTime

GDSN Section	Certification Information Module Diet Information Module
Class Name	CertificationInformation
Attribute Name	certificationEffectiveStartDateTime
Attribute Definition	The date and time upon which the certification is effective.
Implementation Guidance	This date/time applies to a specific certification, as outlined in the rest of the class. This date is the date upon which the item begins to be certified for conditions or requirements of that certification. This is also used for chemical ingredient certifications.

certificationEffectiveEndDateTime

GDSN Section	Certification Information Module Diet Information Module
Class Name	CertificationInformation
Attribute Name	certificationEffectiveEndDateTime
Attribute Definition	The date and time upon which the certification is no longer effective.
Implementation Guidance	This date/time applies to a specific certification, as outlined in the rest of the class. This date is the date upon which the item is not longer to be certified for conditions or requirements of that certification. This is also used for chemical ingredient certifications for the date the supplier or 3rd party performs a chemical assessment upon a trade item formulation. Usually the supplier or third party will issue a certification number for the assessment which would be associated with this date. This tells the recipient the last time an assessment has been done. If a trading partner sees new chemical regulation and a new assessment has not been completed, this will alert the recipient to request updated information.

23.3.6 Change Date

GDSNSection	Trade Item
Class Name	TradeItemSynchronisationDates
Attribute Name	lastChangeDateTime
Attribute Definition	Indicates the point in time where the last modification on a Trade Item was made.
Implementation Guidance	This is a system generated date by the source data pool to help inform the data recipient of the last update or modification by the information provider.

23.3.7 Consumer Availability Date

GDSN Section	Delivery Purchasing Information Module
Class Name	DeliveryPurchasingInformation
Attribute Name	consumerFirstAvailabilityDateTime
Attribute Definition	The first date/time that the buyer is allowed to sell the trade item to consumers. Usually related to a specific geography. ISO 8601 date format CCYY-MM-DDTHH:MM:SS.

Implementation Guidance	This date/time is when the consumer can make a purchase or order an item, whether or not they physically are able to take possession of the item at time of purchase or order. For example - First date upon which an item can be presented to the consumer for purchase- such as New Movie releases in the US is on Tuesdays and not prior.
--------------------------------	--

23.3.8 Community Visibility Date

GDSN Section	Trade Item
Class Name	TradeItemSynchronisationDates
Attribute Name	communityVisibilityDateTime
Attribute Definition	The date from which the neutral trade item information (i.e. not the private information, not relationship-dependent data and not price data) is available to all members of the target data pool, without restriction. Until this date only the data recipients to whom the data source has explicitly published the data can have access to the data. By setting this date a data source gives permission for wider publication of the generic item data.
Implementation Guidance	This date provides the recipient data pool the knowledge when information about a public item can be made available to all data recipients. This is mutually exclusive with the partyReceivingPrivateDataGLN attribute for Australia and New Zealand.

23.3.9 Deposit Value Date

depositValueEffectiveDateTime

GDSN Section	Packaging Information Module
Class Name	PackageDeposit
Attribute Name	depositValueEffectiveDateTime
Attribute Definition	First date that the deposit value is valid for the deposit code. CCYYMMDD
Implementation Guidance	This is the date upon which the deposit value for the GTIN is valid as published in the item message. This date is optional. For some items, there may be multiple deposit values. There can be a different set of dates for the each deposit value. Currently in the item message, this is an issue with correlating the deposit value and country subdivision codes together

depositValueEndDateTime

GDSN Section	Packaging Information Module
Class Name	PackageDeposit
Attribute Name	depositValueEndDateTime
Attribute Definition	Last date that the deposit value in the currency is valid for the deposit code.
Implementation Guidance	This is the last date upon which the deposit value for the GTIN is valid as published in the item message. This date is optional. For some items, there may be multiple deposit values. There can be a different set of dates for the each deposit value. Currently in the item message, this is an issue with correlating the deposit value and country subdivision codes together.

23.3.10 Discontinued Date

GDSN Section	Trade Item
Class	TradeItemSynchronisationDates
Attribute	discontinuedDateTime

Attribute Definition	Date on which the consumer product variant of the trade item, which has been manufactured, is no longer being manufactured. Note: The name of this attribute will change to consumerProductVariantDiscontinuedDateTime in a future release.
Implementation Guidance	The discontinue date should be equal to the last expiry date of the trade item. For items without an expiry date, the date should be equal to the date when the last shipment has been made to the data recipients. The cancel date and the Discontinue date are mutually exclusive and cannot be populated on one GTIN simultaneously. See section 4 of the GS1 General Specifications for more information.

23.3.11 Effective Date

GDSN Extension/Section	Trade Item
Class Name	TradeItemSynchronisationDates
Attribute Name	effectiveDateTime
Attribute Definition	Date on which the information of the master data is valid for order to pay.
Implementation Guidance	The Data Recipient should not apply the changes to the item until this date. If for any reason the date is a date in the past, the changes should be immediately applied by the data recipient. Data Recipients may want this date to be a date in the future. This will provide them notice of the change to allow them time to be ready to accept the change. For more information on early notification of future information, see the section on Item Futurization.

23.3.12 Exclusivity Date

GDSN Extension/Section	Delivery Purchasing Information Module
Class Name	DeliveryPurchasingInformation
Attribute Name	endDateTimeOfExclusivity
Attribute Definition	The Date & Time at which a product is no longer exclusive to that trading partner.
Implementation Guidance	This date is geared toward notification to a trading partner(s) to signify when an exclusivity agreement will end and the item will be made available to other data recipients from the information provider.

23.3.13 File Effective Date

fileEffectiveStartDateTime

GDSN Extension/Section	Referenced File Header Module Referenced File Detail Information Module Safety Data Sheet Module Warranty Information Module
Class Name	ReferencedFileInformation
Attribute Name	fileEffectiveStartDateTime
Attribute Definition	The date upon which the target of this external link begins to be effective for use.

Implementation Guidance	<p>This is the date when the link can begin to be used by the recipient in their business processes as defined by the other attributes in the External File Class.</p> <p>When the link contains several files, this date refers to the individual file which is listed in the fileName attribute.</p> <p>When the link is to a website a start date are optional, but may be used to signify when the site is available for use.</p>
--------------------------------	---

fileEffectiveEndTime

GDSN Extension/Section	<p>Referenced File Header Module</p> <p>Referenced File Detail Information Module</p> <p>Safety Data Sheet Module</p> <p>Warranty Information Module</p>
Class Name	ReferencedFileInformation
Attribute Name	fileEffectiveEndTime
Attribute Definition	The date upon which the target of this external link ceases to be effective for use.
Implementation Guidance	<p>This is the date when the link should stop being used by the recipient in their business processes as defined by the other attributes in the External File Class.</p> <p>When the link contains several files, this date refers to the individual file which is listed in the fileName attribute.</p> <p>When the link is to a website an end date is optional, but may be used to signify when the site is no longer available for use.</p>

23.3.14 Max Buying Quantity Date

startDateMaximumBuyingQuantity

GDSN Extension/Section	Delivery Purchasing Information Module
Class Name	DeliveryPurchasingInformation
Attribute Name	startDateMaximumBuyingQuantity
Attribute Definition	The start date for when the maximum buying quantity is available to the trading partner.
Implementation Guidance	<p>If this date is present, the agreed maximum buying quantity amount is applicable. If maximum buying quantity is present and the date is not present, then the buying quantity is perpetually in effect. The start date is the first date when the agreed maximum quantity is in effect. This date is not meant to apply to the maximum or minimum order quantity or to the order quantity multiple.</p>

endDateMaximumBuyingQuantity

GDSN Extension/Section	Delivery Purchasing Information Module
Class Name	DeliveryPurchasingInformation
Attribute Name	endDateMaximumBuyingQuantity
Attribute Definition	The start date for when the maximum buying quantity is available to the trading partner.
Implementation Guidance	<p>If this date is present, the agreed maximum buying quantity amount is applicable. If maximum buying quantity is present and the date is not present, then the buying quantity is perpetually in effect. The end date is the last date when the agreed maximum quantity is in effect.</p> <p>This date is not meant to apply to the maximum or minimum order quantity or to the order quantity multiple.</p>

23.3.15Min Buying Quantity Date

startDateMinimumBuyingQuantity

GDSN Extension/Section	Delivery Purchasing Information Module
Class Name	DeliveryPurchasingInformation
Attribute Name	startDateMinimumBuyingQuantity
Attribute Definition	The start date for when the minimum buying quantity is available to the trading partner
Implementation Guidance	<p>If this date is present, the agreed minimum buying quantity amount is applicable. If minimum buying quantity is present and the date is not present, then the buying quantity is perpetually in effect. The start date is the first date when the agreed minimum quantity is in effect.</p> <p>This date is not meant to apply to the maximum or minimum order quantity or to the order quantity multiple.</p>

endDateMinimumBuyingQuantity

GDSN Extension/Section	Delivery Purchasing Information Module
Class Name	DeliveryPurchasingInformation
Attribute Name	endDateMinimumBuyingQuantity
Attribute Definition	The end date for when the minimum buying quantity is no longer available to the trading partner.
Implementation Guidance	<p>If this date is present, the agreed minimum buying quantity amount is applicable. If minimum buying quantity is present and the date is not present, then the buying quantity is perpetually in effect. The end date is the last date when the agreed minimum quantity is in effect.</p> <p>This date is not meant to apply to the maximum or minimum order quantity or to the order quantity multiple.</p>

23.3.16Order Date

firstOrderDateTime

GDSN Extension/Section	Delivery Purchasing Information Module
Class Name	DeliveryPurchasingInformation
Attribute Name	firstOrderDateTime
Attribute Definition	Indicates the earliest date that an order can be placed for the trade item.
Implementation Guidance	<p>This date can be populated at the Target Market Level and/or to specific trading partners within the Target Market. If populated in a TM and TPN, then the value is the first date upon which orders will be accepted for the item. If populated for a Specific Trading Partner, then the value is the first date upon which orders from that specific partner will be accepted for the item.</p> <p>Accepted means that the order will be accepted into the order recipient's order system and will be processed beginning on this date. Lead Time should not be considered in the calculation of this date. The value could be August 1 for all recipients, but for a specific trading partner the date might be sent as July 1 as an exclusive offer for that trading partner.</p>

lastOrderDateTime

GDSN Extension/Section	Delivery Purchasing Information Module
Class Name	DeliveryPurchasingInformation
Attribute Name	lastOrderDateTime
Attribute Definition	Indicates the latest date that an order can be placed for the trade item.

Implementation Guidance	<p>This date can be populated at the Target Market Level and/or to specific trading partners within the Target Market. If populated in a TM and TPN, then the value is the last date upon which orders will be accepted for the item. If populated for a Specific Trading Partner, then the value is the last date upon which orders from that specific partner will be accepted for the item.</p> <p>Accepted means that the order will not be accepted into the order recipient's order system and will not be processed after this date.</p> <p>Lead Time should not be considered in the calculation of this date.</p> <p>The value could be July 1 for all recipients, but for a specific trading partner the date might be sent as August 1 as a special offer for that trading partner to aid in closing out inventory.</p>
--------------------------------	--

23.3.17 Packaging Material Launch Date

GDSN Extension/Section	Packaging Information Module Platform Information Module
Class Name	PackagingMaterial
Attribute Name	packagingMaterialLaunchDateTime
Attribute Definition	The first date that a change in packaging material has occurred. This change does not result in a new GTIN at any level of the item hierarchy, such as, an increase or decrease in packaging material and is delivered to the retailer.
Implementation Guidance	There has been a non-major change to the packaging. This date signifies when this new packaging launched.

23.3.18 Permit Date

permitStartDateTime

GDSN Extension/Section	Regulated TradeItem Module
Class Name	PermitIdentification
Attribute Name	permitStartDateTime
Attribute Definition	The start date on which the permit is effective.
Implementation Guidance	<p>This is the date for the actual permit, not the Regulatory Act from where the permit was derived. For example alcohol, tobacco, or fisheries permits.</p> <p>If there are no permit dates, the phrase "COMPLIANT WITH REGULATION" should be populated in the Permit Identification attribute.</p> <p>If the Permit Identification attribute is populated with any other value, then at least one of the dates should be populated.</p>

permitEndDateTime

GDSN Extension/Section	Regulated TradeItem Module
Class Name	PermitIdentification
Attribute Name	permitEndDateTime
Attribute Definition	The date on which the permit expires.
Implementation Guidance	Consult with your local MO for implementation guidance.

23.3.19 Price Effective Dates

effectiveStartDate

GDSN Extension/Section	Sales Information Module
Class Name	TradeItemPrice
Attribute Name	priceEffectiveStartDate
Attribute Definition	This is the effective start date of the price agreed to by the trading partners. This start date is mandatory and, if no end date is communicated, then implies that the price is effective until further notice. Various types of dates may be pre-aligned between buyer and seller. For example, based upon a prior agreement between trading partners this date may relate to any of the following events, first order date, first ship date, and first arrival date.
Implementation Guidance	This date refers to the TradeItemPrice information in the Item Message. This date is the first date upon which the price will be effective or honoured.

effectiveEndDate

GDSN Extension/Section	Sales Information Module
Class Name	TradeItemPrice
Attribute Name	priceEffectiveEndDate
Attribute Definition	The effective end date of the price is optional based upon the agreement by the trading partners. If an invalid end date is communicated, then it is implied that the price and its effective date are effective until further notice. Examples of invalid dates include 99/99/9999, 00/00/0000, blank, etc. These invalid end dates should not be communicated. Various types of dates may be pre-aligned between buyer and seller. For example, based upon a prior agreement between trading partners this date may relate to any of the following events, last order date, last ship date, and last arrival date.
Implementation Guidance	This date refers to the TradeItemPrice information in the Item Message. This date is the last date upon which the price will be effective or honoured.

23.3.20 Production Variant Effective Date

GDSN Extension/Section	Trade Item
Class Name	TradeItemInformation
Attribute Name	productionVariantEffectiveDateTime
Attribute Definition	The start date of a production variant. The variant applies to products having a date mark (a best before date or expiration date) on the package that comes on or after the effective date.
Implementation Guidance	This date is the date upon which the new variant of the GTIN is first going to be produced. Please note that the use of production variant is for minor product changes as detailed in the GTIN Management Standard. This is a non-declared change to the GTIN which does not require a new GTIN, but the manufacturer would like to communicate the change information so that the recipient can update their non-supply chain information. This information is related to the food and beverage extension. For temporary promotional changes, it is recommended that the Trade item Promotional Extension is utilized.

23.3.21 Publication Date

GDSN Extension/Section	Trade Item
Class Name	TradeItemSynchronisationDates
Attribute Name	publicationDateTime

Attribute Definition	A date on which all static data associated with the trade item becomes available for viewing and synchronisation.
Implementation Guidance	This is a system generated date signifying when the publication for this item is created by the information provider. A typical use of this at a data recipient is to aid in message research and data recovery. There is no business process application for this attribute.

23.3.22 Registration Date

GDSN Extension/Section	Catalogue Item Registration Response
Class Name	CatalogueItemRegistrationResponse
Attribute Name	registrationDateTime
Attribute Definition	Date assigned by the registry of successful registration.
Implementation Guidance	This date is assigned by the Global Registry and not by users.

23.3.23 Audio Visual Media Date Time

GDSN Section	AudioVisualMediaProductDescriptionInformationModule
Class Name	AudioVisualMediaDateInformation
Attribute Name	audioVisualMediaDateTime
Attribute Definition	The date for audio or visual media products for example release date.
Implementation Guidance	This attribute is used in conjunction with audioVisualMediaDateTypeCode to specify a variety of dates normally associated with audio visual media products, for example, FIRST_EDITION, LAST_MANUFACTURER_UPDATE, RENTAL_STREET, RERELEASE and THEATRICAL_RELEASE.

23.3.24 Returnable Date

firstReturnableDateTime

GDSN Extension/Section	Delivery Purchasing Information Module
Class Name	OrderableReturnableInformation
Attribute Name	firstReturnableDateTime
Attribute Definition	The first date on or after which non-sold trade items can be returned. This information provides the retailer with any conditions required by the information provider as to the date on or after which non-sold trade items may be returned in order to receive credit from the appropriate party.
Implementation Guidance	This is the date at which the supplier will begin accepting returns for non-sold trade items. Prior to this date, returns for credit may not be accepted.

lastReturnableDateTime

GDSN Extension/Section	Delivery Purchasing Information Module
Class Name	OrderableReturnableInformation
Attribute Name	lastReturnableDateTime
Attribute Definition	The last date AND time when a non-sold trade item must be received by the manufacturer to receive credit
Implementation Guidance	This is the last date at which the supplier will accept returns for non-sold trade items. After this date, returns for credit may not be accepted. Currently, this is only available in the Electronic Game, Film Publication, Music Recording, and Healthcare Extensions

23.3.25 Seasonal Availability Date

seasonalAvailabilityStartDateTime

GDSN Extension/Section	Marketing Information Module
Class Name	Season
Attribute Name	seasonalAvailabilityStartDateTime
Attribute Definition	Indicates the start date of the trade item's seasonal availability.
Implementation Guidance	<p>These dates are specific to a day, month, and year. For seasonal items which are available every year, then the items will need to have a change published to update the seasonal availability dates to be specific to the year.</p> <p>Note: GDSN date attributes are not normally used to populate or provide temporary suspensions or interruptions of service dates.</p>

seasonalAvailabilityEndDateTime

GDSN Extension/Section	Marketing Information Module
Class Name	Season
Attribute Name	seasonalAvailabilityEndDateTime
Attribute Definition	Indicates the end date of the trade item's seasonal availability.
Implementation Guidance	<p>These dates are specific to a day, month, and year. For seasonal items which are available every year, then the items will need to have a change published to update the seasonal availability dates to be specific to the year.</p> <p>Note: GDSN date attributes are not normally used to populate or provide temporary suspensions or interruptions of service dates.</p>

23.3.26 Ship and Delivery Date

firstShipDate

GDSN Extension/Section	Delivery Purchasing Information Module
Class Name	DeliveryPurchasingInformation
Attribute Name	firstShipDateTime
Attribute Definition	Indicates the earliest date that the trade item can be shipped. This is independent of any specific ship-from location.
Implementation Guidance	<p>If the item is shipped via a pick up method, where the buyer uses their own transportation network, this date is the date upon which the first pick up can be accomplished. If the supplier is using their own transportation network to deliver the item to the buyer, this date is the date upon which the first shipments can be accomplished.</p> <p>A supplier in this instance is taken to cover whoever is shipping the goods which may or may not be the actual manufacturer of the goods, for example a distributor.</p> <p>Where both dates are specified for a pair of dates (start and end, first and last, etc.), the end or last date must be equal to or after the start or first date.</p>

lastShipDate

GDSN Extension/Section	Delivery Purchasing Information Module
Class Name	DeliveryPurchasingInformation
Attribute Name	lastShipDate
Attribute Definition	Indicates the latest date that the trade item can be shipped. This is independent of any specific ship-from location.

GDSN Extension/Section	Delivery Purchasing Information Module
Implementation Guidance	<p>If the item is shipped via a pick up method, where the buyer uses their own transportation network, this date is the date upon which the last pick up can be accomplished. If the supplier is using their own transportation network to deliver the item to the buyer, this date is the date upon which the last shipments can be accomplished.</p> <p>A supplier in this instance is taken to cover whoever is shipping the goods which may or may not be the actual manufacturer of the goods, for example a distributor.</p> <p>Note: The last ship date is not Trading Partner Dependent and as such is one date for all data recipients for the specified Target Market.</p> <p>Where both dates are specified for a pair of dates (start and end, first and last, etc.), the end or last date must be equal to or after the start or first date.</p>

23.3.27 Tax Type Effective Date

taxTypeEffectiveStartDateTime

GDSN Extension/Section	Duty Fee Tax Information Module
Class Name	DutyFeeTaxInformation
Attribute Name	dutyFeeTaxEffectiveStartDateTime
Attribute Definition	The effective date on which the tax, fee or duty must start being collected.
Implementation Guidance	Consult with your local MO for implementation guidance.

taxTypeEffectiveEndDateTime

GDSN Extension/Section	Duty Fee Tax Information Module
Class Name	DutyFeeTaxInformation
Attribute Name	dutyFeeTaxEffectiveEndDateTime
Attribute Definition	The effective date on which the tax, fee or duty must end being collected.
Implementation Guidance	Consult with your local MO for implementation guidance.

23.3.28 Registration End Date Time

GDSN Extension/Section	GDSN Chemical Ingredients Extension
Class Name	Registration
Attribute Name	registrationEndDateTime
Attribute Definition	The last date that the registration number is valid.
Implementation Guidance	The registration end date is based upon an agency like the Environmental Protection Agency in the US, issues a registration number for use of a chemical by a supplier. These registrations may sometimes have a limit of use; this would be the date that the registration ends.

23.3.29 Regulated Chemical Sunset Date

GDSN Extension/Section	GDSN Chemical Ingredients Extension
Class Name	Regulated Chemical
Attribute Name	regulatedChemicalSunsetDate
Attribute Definition	As the date from which the placing on the market and the use of a substance is prohibited or restricted.
Implementation Guidance	This is the date which the placing on the market and the use of a substance becomes prohibited or restricted.

23.3.30 Content Date

GDSN Extension/Section	GDSN Trade Item Extension for Books and Publications
Class Name	Content
Attribute Name	contentDate
Attribute Definition	Date information applicable to the Additional Description Information
Implementation Guidance	This is the date that any Additional Description Information was last changed or updated.

23.3.31 Contributor Date

GDSN Extension/Section	GDSN Trade Item Extension for Books and Publications
Class Name	Contributor
Attribute Name	contributorDate
Attribute Definition	The date specified that is associated with the person or organization identified as a contributor.
Implementation Guidance	This is the date that is associated with the creation of the work by the person or organization identified as a contributor and generally corresponds to the copyright date found in the product.

23.3.32 (Books & Periodicals Publication) Date

GDSN Extension/Section	GDSN Trade Item Extension for Books and Publications
Class Name	Publication Date Information
Attribute Name	(Books & Periodicals Publication) date
Attribute Definition	The date specified in the field. Mandatory in each occurrence of the composite, and non-repeating. May carry a dateformat attribute: if the attribute is missing, then indicates the format of the date; if both dateformat attribute and element are missing, the default format is YYYYMMDD.
Implementation Guidance	This is the date that the product was first released in any market.

24 Regulatory Compliance Attributes

Regulatory Compliance Attributes in Trade Item reside in an extension called Regulatory Compliance Extension. From version 2.8 of the Trade Item standard, this extension is deprecated as the attributes are added into Trade Item Core (and made repeatable). This Implementation Guide is common to both implementations, although when still residing in the extension, the attributes cannot be repeated, meaning only one instance of the attributes can be populated.

24.1 Pre-Requisites

- Trading partners wishing to exchange information about trade items
- Adherence to any regulation relevant for the target market of the data recipient that is proven by a reference number

24.2 When Would I Use This?

- The target market of the data recipient has regulations requiring that one or more reference numbers relating to regulatory compliance must be provided

- The data recipient requires that trade items meeting a specific regulatory act are identified and that the permit number is provided.

24.3 Guiding Principles for Regulatory Compliance

In some cases it may be unclear whether a reference number associated with a trade item should be considered an Additional Trade Item Identification Number or if it is a reference proving regulatory compliance. The recommendation is to use the regulatory compliance attributes whenever the number is required based on a regulation and is not primarily used as an additional item number with allocation rules similar or identical to those of GTIN.

The “permit number” may be known as a permit number, a reference number, a licence number, a compliance number or similar phrase. It is not restricted to documents formally headed “Permit”. It may take the form of alphabetic, numeric or other text characters.

24.4 Contents of the regulatory compliance attributes

The regulatory compliance information consists of five attributes

Attribute Name	Cardinality	Definition
regulatoryAct	1..1	The name given to the requirement assigned by the regulatory agency
regulatoryAgency	1..1	The required information is the name of the specific entity in charge of issuing the permit to a company
regulatoryPermitIdentification	1..1	Identification of the permit or licence given by the regulatory agency
permitStartDate	0..1	The start date on which the permit is effective.
permitEndDate	0..1	The date on which the permit expires.

24.5 Examples

24.5.1 Pharmaceuticals in Sweden

Pharmaceuticals in Sweden need some references to identifiers of authority approvals at various levels. There are three approval numbers that identify the:

- sales permit number assigned to a company that is granted permission to sell a specific pharmaceutical in the Swedish market (MT number)
- product approval identifier, regardless of supplier and package type/size (NPL- id)
- product in a specific package type/size from a specific supplier (NPL- pack-id)

24.5.2 MT Number

Attribute name	Value	Comment
regulatoryAct	MT number	Market Authorisation Number
regulatoryAgency	MPA	Swedish Medical Product Agency
regulatoryPermitIdentification	12345	5-8 digit number
permitStartDate	2011-03-21	Start date
permitEndDate	Null	Not used

24.5.3 NPL-ID

Attribute name	Value	Comment
regulatoryAct	NPL-id	National Product Database ID
regulatoryAgency	MPA	Swedish Medical Product Agency

Attribute name	Value	Comment
regulatoryPermitIdentification	12345678901234	14 digit number
permitStartDate	Null	Not used
permitEndDate	Null	Not used

24.5.4 NPL-Pack-ID

Attribute name	Value	Comment
regulatoryAct	NPL-pack-id	National Product Database Package ID
regulatoryAgency	MPA	Swedish Medical Product Agency
regulatoryPermitIdentification	23456789012345	14 digit number
permitStartDate	Null	Not used
permitEndDate	Null	Not used

25 Mergers, Acquisitions, & Divestitures

The phrase mergers, acquisitions and divestitures (abbreviated M&A) refers to the buying (acquisitions), selling (divestiture, also known as divestment or divesture) and combining (merger) of all or part of different companies or businesses. M&A's are normally executed in order to aid, finance or help a company grow rapidly in a given industry. Whether a purchase or unification is considered a merger or an acquisition lies in how the purchase is communicated and received by the target company's board of directors, employees and shareholders.

Both the **Buyers** (companies who are acquiring or merging with another company or business) and **Sellers** (companies who are being acquired or merging with another company or business) will benefit from the use of a comprehensive implementation guideline outlining activities, processes and best practices required during a M&A with reference to managing and communicating product data with their trading partners. They will need to work towards integrating the acquired products into the buyer's portfolio with minimal impact, address issues such as who maintains the right to use the GS1 Company Prefix(es) and the GS1 identification numbers [e.g. Global Trade Item Numbers® (GTINs®), Global Location Numbers, (GLNs), Serial Shipping Container Code (SSCC) etc.] built off of the Company Prefix, when ownership of the product or company changes, and how these changes are communicated with the all their trading partners and GS1 Member Organisations (MOs).

- **Note:** The GS1 Company Prefix is the foundation for all GS1 identification numbers, and it uniquely identifies the company to which it is assigned. When multiple companies use the same Company Prefix it can cause confusion in the supply chain, making unique product identification and product traceability challenging.

Trading partners need M&A implementation guidance to:

- ensure that subsequent use of data is based on a consistent set of terminology and best practice processes, by both buyers and sellers
- enable the buyers and sellers to outline key areas of responsibility and to determine what is expected, and what are acceptable results
- provide the basis for an open relationship between buyers and sellers as well as an understanding of accountability by both parties
- encourage commitment from both the buyers and sellers on key activities with a common understanding of expectations
- contribute to a more timely and seamless M&A

This guide will eliminate confusion on time-lines, reduce multiple meanings for terms and remove the uncertainty on the management and assignment of GTINs as well as promoting standardisation of present practices and bring uniformity to activities, processes and information.

25.1 Overview

This section explains how Trade Items that have been registered and published in the Global Data Synchronisation Network (GDSN) are impacted as a result of an M&A. It will detail:

- actions necessary to move or remove impacted Global Trade Item Numbers (GTINs) from an Information Provider (IP)
- a recommended communication process to share M&A details with Trading Partners receiving GDSN messaging for the impacted GTINs
- timing of each of these actions

Many different classes or types of mergers and acquisition exist in the business world. Since the impact to the GDSN is not predicated by class or type, this implementation guide will address M&A's broadly.

GDSN Implementation steps vary based on legal agreements, the breadth of the product portfolio impacted and by the supply chain execution. These differences will be explained in Section [25.5.1](#).

25.1.1 Merger Defined

In business or economics a merger is a combination of two companies into one larger company. Such actions are commonly voluntary and involve stock swap or cash payment to the target organisation.

In the pure sense of the term, a merger happens when two or more companies, often of about the same size, agree to go forward as a single new company rather than remain separately owned and operated.

- Operations and identities are integrated
- Shareholders come together to benefit from the resources of the enlarged organisation

Figure 25-1 Mergers

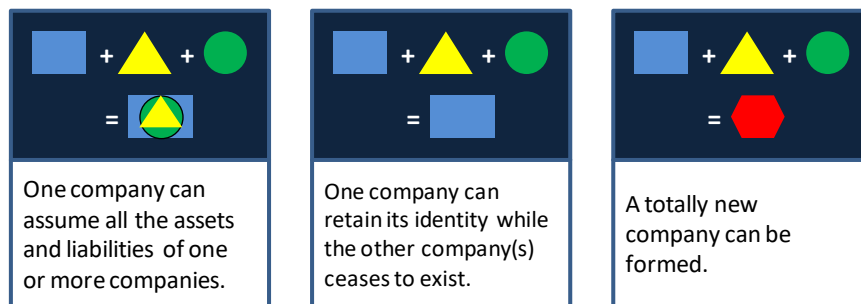

A merger can resemble a takeover but it often results in a new company name (the combination of the names of the original companies) and possibly, in new branding. In some cases, terming the combination of companies a "merger" rather than an acquisition is done purely for political or marketing reasons.

25.1.2 Acquisitions & Divestitures Defined

An acquisition is the purchase of a company or a portion of a company by another company.

When one company completely takes over another and clearly establishes itself as the new owner, the purchase is called an acquisition. From a legal point of view, the acquired company ceases to exist, the buyer consumes the business and only the buyer's stock continues to be traded. The acquisition process is very complex, with many dimensions influencing its outcome.

Divestitures are the actions or process of selling off subsidiary business interests or investments.

Various types of acquisitions/divestitures can be executed such as;

- The shares of a company are acquired (**Full Acquisition**)

- Some or all of the assets are acquired
- A portion of an existing company (**Partial Acquisition**) is acquired
- An existing company **Splits** into two separate new legal entities
- An existing company **Sells** part of its operation to another company (divestiture)

25.1.3 M&A GDSN Pre-Requisite

- The current Information Provider and/or the new Information Provider must subscribe to the GS1 system through a GS1 Member Organisation (MO)
- All parties must have a Global Location Number (GLN) assigned to their organisation
- One party (the purchaser or the seller) involved in the M&A must exchange data across the GDSN using a certified Data Pool
- A GS1 Company Prefix (GCP) is utilised in the creation of a GTIN

25.1.4 When Would I Use This?

The guide should be used when a M&A impacts:

- Global Trade Item Numbers (GTINs) that have been Registered and Published via GDSN
- a change in Information Provider (IP) or Brand Owner
- Global Location Number (GLN) changes as a result of a M&A.
- The M&A Trade Item Implementation Guide can be utilised to determine the best practices to facilitate the timely notification of these impacts to the community. It contains guidelines to follow for establishing new trade item Brand Owners, new Information Providers, new GTINs and key facts that should be communicated to Trading Partners receiving GDSN messages for the impacted GTINs. It is imperative that key information is conveyed to all impacted Trading Partners in the value chain within a reasonable period of time.

25.1.5 Background Material

Section 1.6 of the [GS1 General Specifications](#) contains rules for maintaining GS1 Company Prefixes and GS1 identification keys (GTINs) when a M&A occurs. This information should be reviewed in order to understand how these rules effect GDSN processing. The GTIN Management Standard and GLN Allocation Rules are specified in the [GS1 General Specifications](#) (sections 4.5 and 4.6) and all parties should be familiar with them.

GTINs that are exchanged via the GDSN must be registered in the Global Registry. This registration is performed for each GTIN, GLN, and TM (Target Market) combination. The Global Registry verifies the uniqueness of every GTIN, GLN, TM combination, ensuring only one combination exists worldwide. Changes to a GTIN registration key (GTIN/GLN/TM) as a result of a M&A must follow the GDSN Business Message Standards (BMS). Please see [GDSN standards](#) to gain more in depth knowledge of this process.

25.2 Business Definitions for terminology and dates used in various M&A Scenarios

Following are definitions for terminology or dates that will be used to describe various M&A Scenarios and/or Best Practice Guidelines.

25.2.1 Business Terminology

The following section provides information on various M&A related business terms.

25.2.1.1 Brand Name

A word, name, banner, symbol (especially one legally registered as a trademark) used by a merchant, manufacturer, or service provide to identify its products/services distinctively from others of the same type. The product brand is usually prominently displayed on a company’s goods and in advertising.

Figure 25-2 Sample Brand Names



25.2.1.2 Product Range

Different formulas, designs, forms, types or variations of a brand name leverage across multiple unrelated product categories (i.e. Beverages, Sauces, Biscuits, and Detergents). A Product Range can be a complete portfolio of products that a firm sells or an organisation may market products under several product ranges.

Figure 25-3 Sample Product Range



Company with a **single** product range for **multiple** product categories sold under a **single** brand name.

Company with **multiple** product ranges for **multiple** categories sold under **multiple** brand names.

25.2.1.3 Product Group, Product Family or Product Line

These are groups of items that are closely related, either because they function in a similar manner, are sold to the same customer groups, are marketed through the same types of outlets, or fall within given price ranges.

A **Product** group uses similar or the same production processes, have similar physical characteristics, and may share customer segments, distribution channels, pricing methods, promotional campaign and other elements. Products comprising a family are usually priced and discounted as a group. (i.e., buy any 2 XYZ Healthcare Company products and receive a \$1.00 off your purchase.)

Figure 25-4 Sample of a Product Group/Line

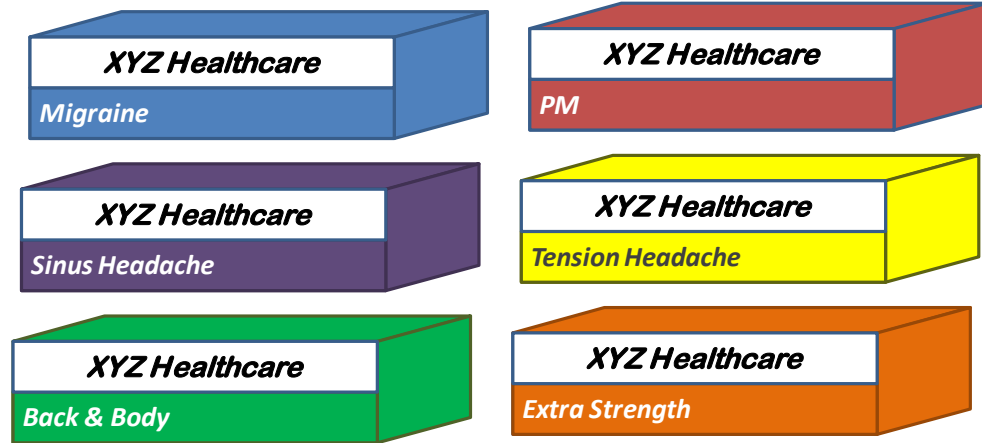

25.2.1.4 GS1 Company Prefix (GCP)

The GS1 Company Prefix (GCP) is a variable length number licensed to an organisation by a GS1 Member Organisation. Organisations use GCPs to create GTINs and Global Location Numbers (GLNs) as well as other GS1 identification keys. Companies may subscribe to one or more GCPs, in order to meet the requirements of their product portfolios and branding practices.

A GTIN includes a GCP and a unique item reference assigned by the GCP subscriber (or, in some countries, by the GS1 Member Organisation). GTINs are always 14 digits, but can be represented in barcode symbols with one or more leading zeroes omitted depending on the selected barcode standard's constraints. The GCP always starts at the second position (from the left) of the 14-digit string. If the first digit of the GCP is a zero (GS1 Prefixes 000-019) then the string with the leading zero omitted is termed a U.P.C. Company Prefix. The number of digits available for use as an item reference in the GTIN is contingent on the GCP length.

Figure 25-5 Sample of a GCP in a GTIN Structure



To Create a GTIN, an Organisation with a 7-Digit GCP must create a 5-digit item reference.

Company Prefix: 7612345

			
	Small	Medium	Large
Item Reference	00001	00002	00003
Check Digit	4	1	8
GTIN	07612345000014	07612345000021	07612345000038
GTIN-13 representation	7612345000014	7612345000021	7612345000038

To Create a GTIN, an Organisation with an 8-Digit GCP must create a 4-digit item reference.

Company Prefix: 01234567 (=U.P.C Prefix: 1234567)

			
	Small	Medium	Large
Item Reference	00001	00002	00003
Check Digit	7	4	1
GTIN	00123456700017	00123456700024	00123456700031
GTIN-13 representation	0123456700017	0123456700024	0123456700031
GTIN-12	123456700017	123456700024	123456700031

25.2.1.5 Transition Period

This is the physical amount of time that is agreed upon by the Buyer and Seller to execute the terms of their M&A. Normally, this is the period of time that the Seller commits to provide certain services on behalf of the new Buyer.

The Transition Period, updates to Transition timeline, if necessary should be communicated to Trading Partners. This communication occurs outside of the GDSN and should occur prior to any changes to transactions flowing through the GDS Network.

- **Note:** Transition time lines will vary by M&A agreement. The timing is determined independently between the impacted organisations.

25.2.1.6 Transition Service Agreement (TSA)

This is a Post-closing agreement between a Buyer and Seller as a result of the M&A. TSAs occur in situations, where it can take a period of time to replace corporate functions (IT, legal, accounting, distributions, warehousing) that had previously been provided by the parent company but were not included with the sale of the business or, where it will take time to integrate these functions into a single new process.

Details of the TSA are shared with Trading Partners to ensure they understand how business will be conducted this interim period.

Figure 25-6 Sample TSA Communication to a Trading Partner

Dear Customer,

*This is to announce the legal ownership sale of Prince Edward branded confections products from the ABC Corporation to the XYZ Corporation, effective June 15, 2007. ABC Corporation has entered into a contractual agreement with XYZ Corporation to continue to manage all business processes until the conclusion of a Transition Service Agreement (TSA). **This transition period could last as long as nine months beyond the legal ownership transfer date of June 15, 2007.***

ABC Corporation will continue to perform all processing functions related to the selling, ordering, invoicing and distribution of the Prince Edwards branded confections products. All customer orders will continued to be entered and prepared in accordance with ABC Corporations policies through the conclusion of this TSA agreement. This means that customers should not change vendor structures for Prince Edwards branded confections products during the TSA

timeframe. All Prince Edwards branded confections orders should continue to be placed on ABC Corporation POs and they will continue to be shipped on ABC Corporation trucks. The Prince Edwards branded confections businesses will be billed on separate invoices but will remain part of ABC Corporations distribution network during the transition period. No changes to the remittance or payments will occur. ABC Corporation's goal is to continue to provide quality services to customers throughout the TSA.

25.2.2 Date Terminology

25.2.2.1 Announcement Date

This is the date when news or an event concerning a given company is announced to the public. Researchers use these announcements to evaluate the economic impact of events of interest. For example, when a company hires a new CEO, the announcement date is the day it is released or announced to the media. The Announcement occurs outside of GDSN processes.

Figure 25-7 Sample Divestiture Announcement to the General Public

K-Foods Announces Agreement to Sell Pizza Business to N-Foods

Northfield, Ill., Jan. 5, 2010 – K-Foods today announced that, after several months of discussions, it has agreed to sell the assets of its North American pizza business to N-Foods for a total consideration of \$3.7 billion. The company estimates that its pizza business generated 2009 net revenues of \$1.6 billion, under U.S. Generally Accepted Accounting Principles. The sale, which is subject to customary conditions including regulatory clearances, includes the DIG, TMM, and JAK Brands in the United States, the DIB Brand in Canada and the CAF Pizza Kitchen trademark license. It also includes Wisconsin manufacturing facilities (Medford and Little Chute) and the right to take on the leases for the pizza depots and delivery trucks. K-Foods anticipates that approximately 3,400 employees will transfer with the business to N-Foods.

The transaction is expected to close in 2010.

25.2.2.2 Start Date

This is the date upon which something is **considered to take effect** or becomes official. This is normally different from the date upon which an event actually occurs, is recorded or announced.

With electronic information sharing, this date reflects the **official date upon which the information content of the message becomes valid**. This date can be used for an initial trade item offering or to mark a change in the information related to an existing trade item. With changed information, the start date indicates when the changes take effect. This date signifies when information can be used for business transactions.

25.2.2.3 Transmission Date

Normally, a system generated date to reflect when updates or modifications occur and are recorded as an official record.

If the Transmission Date is in advance of the Start Date, the Information Provider is giving an advanced notice of the record change to the Data Recipient.

25.2.2.4 Non- Active Date

This is the date from which information about a trade item **can no longer be obtained** from a specified Information Provider by a Data Recipient. The Information Provider will no longer share, add or update information about the Item with Data Recipients via GDSN.

25.2.2.5 Inactive Date

This is the date upon which the Information Provider desires information about a trade item to **stop being available** from an Information Provider. The Information Provider uses this date to signal that the item is now considered inoperative by their organisation.

- **Note:** This timelines varies by Industry and/or Sector. Please see [GDSN standards](#) for the specific GS1 standard.

Figure 25-8 Sample Date Usage

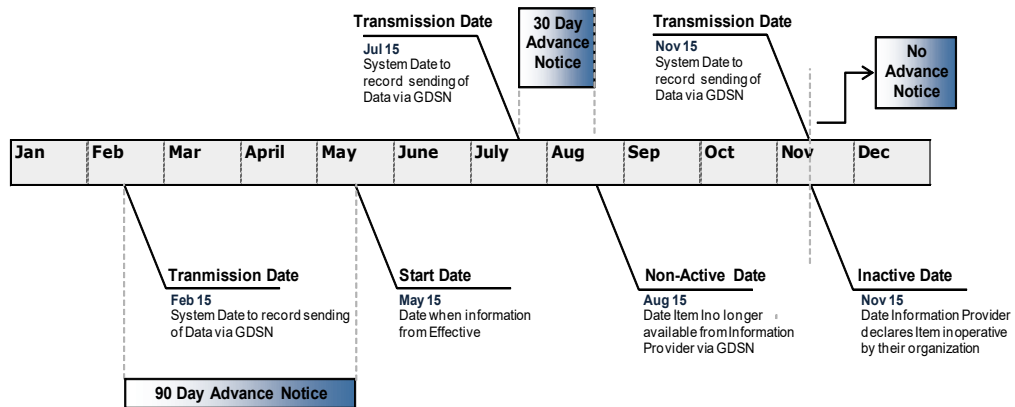

25.2.2.6 Date Attributes in GDSN

The date definitions above reflect the stages of a M&A activity. In GDSN, there are many date attributes. More details are given in [Section 23 Dates](#).

Current practices and expectations are not consistent. For example, some trading partners mainly use First Order Date and Last Order Date to indicate when trade items are first available or are no longer available. Other trading partners may choose to use Start Availability Date Time and End Availability Date Time. For this reason no single recommendation has been made in this topic regarding the GDSN attributes to use for Start Date Time and Non-Active Date. For the latest advice, users are recommended to refer to [Section 23 Dates](#). They may also obtain useful advice from their GDSN Data Pool or GS1 Member Organisation.

Discontinue Date Time is the recommended GDSN attribute for the Inactive Date.

25.3 M&A Best Practices for effective GDSN Item Catalogue Setup

Following are recommended best practices principles to be deployed by Trading Partners to facilitate changes that result from M&As.

25.3.1 New GTINs / New Information Providers

When new GTINs must be established or when an existing GTIN Information Provider must be changed:

- Treat the communication as a New Item introduction - Follow Trading Partners Standard New Item Lead time requirements
- Publication message type will generally be "New" versus "Initial Item Load" - This practice will vary by Trading Partner

Figure 25-9 New Item Process Timeline

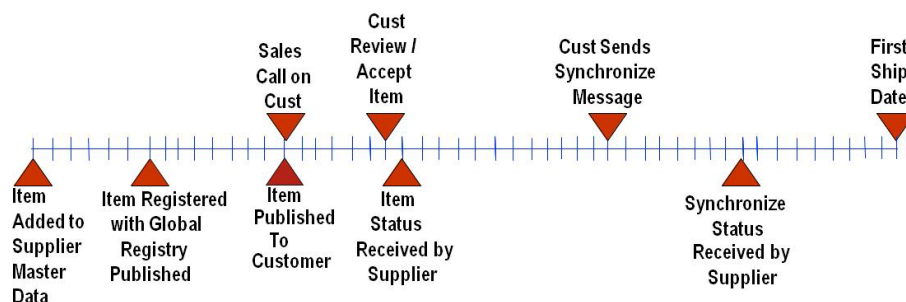

25.3.2 Advance Notification

Provide an **Advance Notification** of new GTINs or key Item Changes to allow trading partners time to gain new item acceptance, set up their internal systems, and establish shelf and/or warehouse space.

- This advance notification can occur outside as well as via the GDSN
- If using GDSN for advanced notification, set the **Transaction Date** in advance of the **Start Date** (The length of advance notice timeline can be relationship specific)
 - For more information, refer to [Section 11 Item Futurisation](#).

If an attribute is changed for a trade item **that impacts** a purchase order configuration or requirement, provide an advanced notice of the change

If an attribute is changed on a trade item that **does not impact** purchase order configuration, send the record when the record should be active

25.3.3 Replacement and Replace by GTINs

When it is necessary to assign new GTINs as a result of a M&A (or is a GTIN Management Standard rule impact) it is recommended that the Seller and Buyer utilise the **"Replaced By GTIN"** and the **"Replaces GTIN"** attributes show this relationship to prior GTINs. Establishing this relationship:

- Facilitate Master Data alignment
- Link historical inventory movement
- Enhances product Traceability even with a change in Information Providers

Sample Use: M&A occurs where the Seller retains ownership of the GCP used in the GTIN scheme. This results in new GTINs for the purchased product by the Buyer

Figure 25-10 Replacement and Replace by GTINs

When Seller removes GTIN from Network	When Buyer Adds New GTIN to the Network
GTIN: 00021000123456	GTIN: 00088430123459
Replaced By GTIN: 00088430123459	Replaces GTIN: 00021000123456

25.3.4 Brand Ownership Change

If a Brand is sold to another company, the Seller should reflect the sale via GDSN by updating the **"GLN of the Brand Owner"** for the impacted GTINs soon as the Sale is finalised.

- This does not change the Information Provider of the GTIN
 - Signifies only brand ownership change
 - This can be communicated before the physical operations transitions are completed
- **Note:** The Seller in the short term is acting according to the details of the Transition Service Agreement (TSA). Often there is a short period immediately after the M&A takes effect when the Buyer is not in a position, normally due to system and procedural constraints, to exercise his "normal" responsibilities. This is why the TSA is important, to set out explicitly who does what immediately following the M&A.

25.3.5 Advance GTIN Publication

A Data Source can **register** a GTIN in advance of publishing the information to a Trading Partner. For example:

- GTIN Registration Date: Jan 15, XX01
- GTIN 1st Publication Date: Mar 15, XX01

Rationale for advanced Registration:

- Reserves GTIN number Globally
- Complete GTIN Registry validations
- Data can be change as frequent necessary without GDSN constraints that occur after publication

25.4 GDS Flexibility that drive varying Trading Partner Execution Partner and Core GDS Concepts

The GDSN Model allows Trading Partners flexibility in setting up or establishing the level at which for various messages are received or processed. This design was enabled to facilitate linkage existing internal legacy systems and therefore as a means to expedite GDSN adoption.

A review of areas where setup/business practice can vary by Trading Partner will help the reader understand the M&A implementation steps detailed later in the guide. Additionally, a few core GDS concepts will also be covered in this section to ensure the reader understand why specific changes are requirement when a M&A is executed.

25.4.1 GDS Flexibility by Trading Partner

How record received in advanced of the official start date are processed by Data Recipients

- Many hold the transaction and stage the data to process when effective
- Some only accept for execution on the start date

Data Owners should understand the business practices of their Trading Partners and work with their Data Pools as necessary to facilitate effective communication and data setup.

Timing of the alignment of product records from one Data Owner to another can be based on many different factors:

- When inventory is depleted from prior owner
- When Purchase Order configurations are impacted
- When Sales Relationship Changes
- Immediately upon notice

As a result, the timeline associated with a M&A implementation can vary significantly. Only the process steps will remain common.

A level at which a Data Recipient establishes their Subscriptions may or may not impact future communications of M&A GTIN.

Subscription Level	Impact GDSN Communications?
By GLN	Yes
By GTIN	Yes
By Target Market	Depends
By GPC	No

The timing for communicating a GTIN Inactive Date and whether to use both a GTIN Non-Active Date and an Inactive Date will vary by Data Source.

- Data Sources may base this decision on Inventory deployment, Master Data record management, Business requirements to process Receivables for the impacted products.
- Data Recipients may link both or only one of these Dates to product Re-Ordering.

- **Note:** It is important to remember that only the Inactive Data impacts a GTIN record status in the Global Registry.

The following chart displays the timing of when a Data Source starts, the GTIN reuse Rules, and how communicated to the Global Registry. This will be predicated based on the Data Source internal record needs.

Timing	Method
On the Transition End Date	Advanced Inactive Date
A period in time after the Transition End Date	Using the Non-active date to correlate to the transition end date and following up with an Inactive Date with no advanced notice
On the Transition End Date	Inactive Date set to match Transition End Date

25.4.2 Core GDS Concepts

Concept 1: The products associated with M&As are normally:

- Not new to the marketplace
- Not new to a customer

As a result, Data Recipients will normally have some internal records for these products prior to when the M&A occurs. Data Recipients may use different methods and timing to process changed/updated data received via GDSN as a result of a M&A.

Table 25-1 Concept 1: Example of changes to internal records for existing products before and after M&A

Retailer Setup before M&A			Retailer Setup after M&A with New GTIN		
GDS Attribute	Possible Retailer Structure		GDS Attribute	Possible Retailer Structure	
Information Provider GLN	Vendor Code	Manufacture GLN	Information Provider GLN	NEW Vendor Code	NEW Manufacture GLN
Brand Owner	Vendor Code		Brand Owner	NEW Vendor Code	
GTIN	Internal Item Code	GTIN	GTIN	Internal Item Code	NEW GTIN

Concept 2: GTINs are registered with the Global Registry based on a registration Key. This registration key is the combination of GTIN, GLN and TM.

If the Registration Key (GTIN/GLN/TM) is **impacted by** the M&A:

- data cannot be transferred from one owner to another
- registration of the GTIN with the new Key must occur which requires new Trading Partner publications

If the GTIN Registration Key is **NOT impacted**:

- registered GDSN Data ownership can transfer to new owner
- minor updates to GTIN Item attributes may occur (i.e. Brand Owner GLN)
- existing Trading Partner publications and Data Pool Sync List remain intact

Concept 3: GCP Subscriptions, permanent or temporary, must be managed with the issuing GS1 Member Organisation

Data Recipients, Data Pools, and GS1 MOs should confirm that a GCP has been correctly registered with the responsible GS1 MO. They are encouraged to use GEPIR for this task.

- **Note:** In North America, legacy company prefixes may be owned (rather than subscribed to or licensed) by the organisation.

Concept 4: GTINs are comprised of a GS1 Company Prefix (GCP):

- if a new GCP is necessary, this equates to the need for new GTINs
- GTINs in existence prior to M&A and developed prior to completion of agreed upon transition plan may be temporarily used by new owners

- **Note:** Timing of the temporary use should be aligned with the [GS1 General Specifications](#) (available from your local GS1 Member Organisation).

- **Note:** For GTINs that are individually issued by a GS1 Member Organisation, please refer to your GS1 MO for guidance.

25.5 High-level Process Steps to execute a M&A

There are 5 basic steps for effectively portraying the outcome of a M&A to Trade Items that have been synchronised between Trading Partners via GDSN.

Figure 25-11 Process Steps to execute M&A

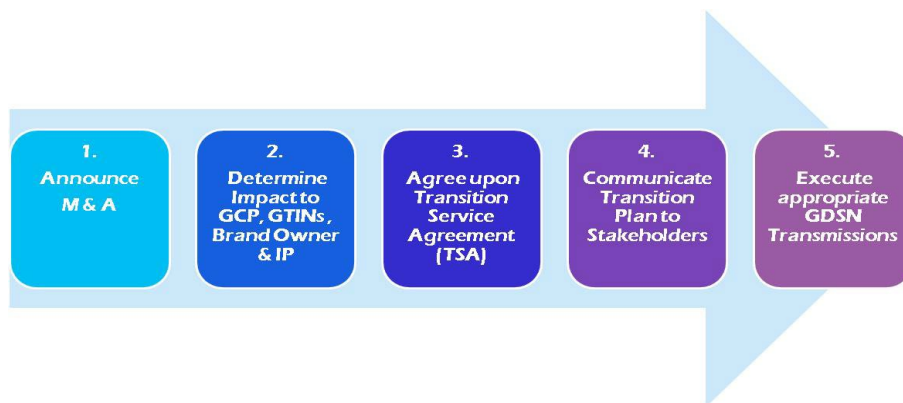

Step 1: Announce the M&A to the Public.

After the successful agreement of a M&A, the organisations involved will normally publicly announce the outcome of the M&A. The publication normally includes the business objective of the M&A, tentative structuring plans and potential timing.

The announcement of a M&A is handled outside of the GDSN process. M&A announcements are made in press releases, notices on the organisations websites, public news sources and trade releases. Generally organisations involved in the M&A will develop specific employee and customer communications to ensure key stakeholders are apprised of the situation and its expected outcomes. While in most countries the M&A can be publicly announced upon agreement between the involved parties, local government regulations and agencies approvals can impact the end state of the M&A and the timing of integration activities.

Normally, other than general interest, business practices with Trading Partners will not be impacted immediately when the M&A is announced.

How your company deals with merger issues such as communication, customer notification and integration of systems will play a huge role in determining the overall success or failure of data synchronisation before, during and after the merger or acquisition.

Don't wait until the deal is finalised to think about these issues. Assemble a team of stakeholders and experts to analyse the challenges and risks of integrating the two companies and have an action plan in place long before the official merger date.

Step 2: Determine the impact on GCP, GTINs, Brand Owner & Information Provider

During M&A negotiation, organisations are limited to the information they can legally share with each other or to which the organisations desire to share with each other. As a result, immediately after the close of the M&A and public announcement, the organisations begin to exchange strategic information necessary to obtain their sought after M&A end state.

The information exchanged during this time includes, the assessment of the products and services that will be carried forward, integrated or terminated in the future. This also includes the analysis of physical locations, plants and offices, employees and other resources.

During this time, the organisations should also determine the impact of the M&A to their existing:

- GCP Subscription (section [25.4.2](#))
- GTIN Scheme
- Brand Ownership
- GDSN Item Catalogue Information Provider structure

The outcome of this assessment will determine potential changes to products that will be necessary to communicate to GS1 Organisations, Employees, Data Pools and Trading Partners.

Step 3: Agree upon the Transition Service Agreement (TSA)

Typically, there is a time lag between the announcement date and the time when physical changes in ownership take place. M&A implementations are normally staged based on the time and resources available to make changes, the market impact of the changes, necessary system reconfigurations and legal implications.

Organisations assemble a team of stakeholders and experts to analyse various challenges and risks on how to execute the M&A. The team develops and agree upon a transitional and long term action plan. This is normally targeted to be completed within the first month following the M&A announcement. The outcome of this team is developed into a Transition Service Agreement (TSA). This captures how all the agreed processes will be handled prior to and after the physical transfer of the M&A impacted assets.

- **Note:** Make sure that this communication is shared with the Retailer's GDS contact to ensure a smooth transition.

During the transition period, changes to business practices are usually minimised. Business practices, including GDS transactions (new item introductions, item changes and corrections, GDSN message) continue as prior to the M&A announcement.

Step 4: Communicate Transition Plan to Stakeholders

After agreement to the Transition Service Agreement (TSA), key facts should be officially communicated to stakeholders to ensure their alignment and understanding of current and future processes.

In addition to the normal business process impact, these plans should detail:

- GTIN impact based upon the rules established in section 1.6 of the [GS1 General Specifications](#)
 - Item Catalogue Information Provider (IP) impacts
 - Brand ownership changes
 - the estimated timeframe to implement the GDSN changes
- **Note:** This communication occurs outside of the GDSN. The GTIN publications, changes etc. will follow the announced plan.

Step 5: Execute appropriate GDSN Transmissions

The final step in the process to execute the necessary GDSN transmissions as identified in the prior steps. The steps are detailed in the section below “GS1 Change Situations & Steps Required”.

25.5.1 Key Factors for Managing a M&A via GDSN

The impact on four key attributes as a result of a M&A determines what actions are necessary to manage GDSN communications. The four key attributes are:

- GTINs
- The GCP use for GTIN composition
- GLN of the Information Provider (IP)
- Brand Owner GLN

The need to update or change any of these attributes is driven by the GS1 GCP standards, the impacted organisations existing GDSN Item Catalogue setup and their GLN structures.

The following matrix displays each possible attribute outcome that can occur according to changes in each of these four attributes. Each M&A should be assessed against this matrix to determine the appropriate Standard GDSN action steps that should be taken to effectively manage GTIN setup and GDSN Item Catalogues.

Table 25-2 M&A Attribute Impact

Situation #	M & A Attribute Impact			
	GTIN #	GCP for GTIN Structure	IP	Brand Owner GLN
1	New GTINs	New GCP for GTIN Composition	New IP	New Brand Owner GLN
2	GTINs Retained	GCP Retained	New IP	New Brand Owner GLN
3	GTINs Retained	GCP Retained	IP Retained	New Brand Owner GLN
4	GTINs Retained	GCP Retained	New IP	Old Brand Owner GLN
5	New GTINs	New GCP for GTIN Composition	New IP	Old Brand Owner GLN

25.6 M&A Business Scenario Summary

Here is a summary of the 16 most common Business Scenarios. Each Scenario is described in business terms in the next section. Analysis shows that each Scenario leads to a single “Situation” combination of requirements for changes in GDSN, known here as a “GS1 Change Situation”.

Table 25-3 Business Scenario Summary

Scenario #	Business Scenario	Change Situation
Scenario 1:	Partial Divestiture/Acquisition: Product Range sold with a Shared GCP	25.8.1
Scenario 2:	Split: A Company with a Single GLN splits into 2 New Organisations	25.8.1
Scenario 3:	Full Acquisition / Total Company Merger: A Full Company merger into a single Item Catalogue and single GCP	25.8.1
Scenario 4:	Full Acquisition / Total Company Merger: A Company is fully acquired by another company with future consolidated Item Catalogues.	Situation 2: Changed Ownership Retains Item Numbers
Scenario 5:	Partial Divestiture/Acquisition: Product Range sold with a Unique GCP	Situation 2: Changed Ownership Retains Item Numbers

Scenario #	Business Scenario	Change Situation
Scenario 6:	Partial Divestiture/Acquisition: Product Range sold with a Shared GCP and future Production/Distribution Rights	Situation 2: Changed Ownership Retains Item Numbers
Scenario 7:	Full Acquisition / Total Company Merger: A Full Company merger with separate Item Catalogues	25.8.3
Scenario 8:	Partial Divestiture/Acquisition: Product Range sold with a Shared GCP & future Brokerage Rights	25.8.3
Scenario 9:	Partial Divestiture/Acquisition: Product Range sold with a Unique GCP & future Brokerage Rights	25.8.3
Scenario 10:	Licence Agreement with Full Rights: brand agreement for a specific product line: Licensor Allocates Item Numbers	25.8.4
Scenario 11:	Change in Broker/Distributor for a Product Range who maintains Item Information	25.8.4
Scenario 12:	Licence Agreement with Full Rights: brand agreement for a specific product line: Licensee Allocates Item Numbers	Situation 5: New Arrangements with No Change of Brand Owner

25.7 M&A Business Scenario Details

Here are the details for each Business Scenario. A link is included to each GS1 Change Situation. The details of the steps to be carried out in GDSN for each GS1 Change Situation are detailed in the next section.

Following are examples of general M&A scenarios that occur regularly. These scenarios have been aligned to one of the Standard M&A GDSN Situation Steps. This alignment should be used by readers to access how a particular situation should be executed to facilitate the GDSN setup.

25.7.1 Situation 1: Complete Change

These Business Scenarios all link to [GS1 Change Situation 1](#); New GTINs, New GCP for GTIN Composition, New Information Provider GLN and New Brand Owner GLN

Business Scenario	Business Circumstances
<p>Scenario 1: Divestiture/Acquisition: A Product Range sold with a Shared GCP</p>	<p>A Product Range is purchased from a company whose GTIN numbering scheme consists of a GCP that will be retained by the selling company.</p> <p>As a result, the Acquiring company will need to establish new GTINs for the acquired products with a GTIN scheme comprised of a GCP owned by the Acquiring company. This will require registration of the new GTINs with the Global Registry as well as new publications to trading partners to reflect the new GTINs and new IP GLN associated with the acquired products.</p> <p>It will also require the divesting organisation to remove publications for the prior, obsolete GTINs and to record a discontinuation date with the Global Registry.</p> <p>The timing of these transactions will be negotiated between the two organisations and specified in their Transition Service agreement.</p>

Business Scenario	Business Circumstances
<p>Scenario 2: Split: A Company with a Single GLN splits into 2 New Organisations</p>	<p>A Company splits its assets into 2 new organisations. Prior to the split, the company utilised a single GCP for all products owned by the organisation.</p> <p>In order to minimise the impact on the supply chain, the existing GCP will usually be retained by the new organisation that will have the largest number of GTINs under the new company structure. This new company will be able to retain all existing GTINs, IP GLNs and Brand Owner GLN declaration.</p> <p>The other new company will need to establish new GTINs for their products with a GTIN scheme comprised of a new GCP obtained from their GS1 Member Organisation. This new setup will require registration of the new company's GLN and GTINs with the Global Registry as well as new publications to trading partners to reflect the new GLN, GTINs and new IP GLN associated with the products.</p> <p>The organisation with the larger number of GTINs that retained the prior GCP will need to remove publications for the prior, obsolete GTINs for the product they will no longer own. This organisation must also record a discontinuation date for those obsolete GTINs with the Global Registry.</p> <p>The timing of these transactions will be negotiated between the two organisations and specified in their Transition Service agreement.</p>
<p>Scenario 3: Full Acquisition / Total Company Merger: A Full Company merger into a single Item Catalogue and single GCP</p>	<p>A company is entirely purchased by another company. The Acquiring company will own all products from the previous company. This includes the GTIN scheme and the GCPs previously owned by the prior company. The Acquiring company business practice is to use a single GCP for all products owned by the company. They have elected to change the GTIN scheme on all their newly-acquired products to use this same single GCP.</p> <p>To execute this process, the acquiring company will need to establish new GTINs for the acquired products with a GTIN scheme comprised of their single GCP. This will require registration of the new GTINs with the Global Registry as well as new publications to trading partners to reflect the new GTINs and the new IP GLN associated with the acquired products.</p> <p>It will also require the divesting organisation to remove publications for the prior, obsolete GTINs and to record a discontinuation date for those obsolete GTINs with the Global Registry.</p> <p>The timing of these transactions will be negotiated between the two organisations and specified in their Transition Service agreement.</p>

25.7.2 Situation 2: Changed Ownership Retains Item Numbers - with New Publisher

These Business Scenarios all link to [GS1 Change Situation 2](#); GTINs Retained, GCP Retained, New Information Provider GLN and New Brand Owner GLN

Business Scenario	Business Circumstances
<p>Scenario 4: Full Acquisition / Total Company Merger: A Company is fully acquired by another company with future consolidated Item Catalogues.</p>	<p>A company is entirely purchased by another company. The Acquiring company will own all products from the previous company. This includes the GTIN scheme and the GCPs previously owned by the prior company.</p> <p>The Acquiring company elects to keep the acquired products GTIN scheme intact but chooses to consolidate their GDSN item catalogue into their existing GDSN item catalogue. The acquired products will be published using the purchasing company's prior GDSN IP GLN.</p>

Business Scenario	Business Circumstances
<p>Scenario 5: Partial Divestiture/Acquisition: A Product Range sold with a Unique GCP</p>	<p>A Product Range is purchased from a company whose GTIN numbering scheme for the purchased products contain a unique GCP, used previously by the Seller for only the products divested. As a result, the Seller has agreed to transfer ownership of this GCP to the Acquiring organisation. This results in less disruption in the supply chain.</p> <p>The Acquiring organisation will retain all previous GTINs and the GCP for the acquired products. They intend to consolidate the acquired products into their existing GDSN item catalogue. This will require new registration with the Global Registry as well as new publications to trading partners to reflect the new IP address associated with the acquired products.</p> <p>It will also require the divesting organisation to remove publications for these GTINs previously published under their IP GLN and to record a discontinuation date with the Global Registry.</p> <p>The timing of these transactions will be negotiated between the two organisations and specified in their Transition Service agreement.</p>
<p>Scenario 6: Partial Divestiture/Acquisition: A Product Range sold with a Shared GCP and future Production/Distribution Rights</p>	<p>A Product Range is purchased from a company whose GTIN numbering scheme for the purchased products contain a unique GCP, used previously by the Seller for only the products divested. The new Owner has decided to engage the Seller to continue to Produce/Distribute the acquired product line. The Seller will receive a fee from the new Owner for their on-going production/distribution services. The Acquiring company will assume Marketing, Sales and Invoicing for the acquired products. The Seller has agreed to transfer ownership of this unique GCP to the Acquiring organisation. This results in less disruption in the supply chain.</p> <p>The Acquiring organisation will retain all previous GTINs and the GCP for the acquired products. They intend to consolidate the acquired products into their existing GDSN item catalogue. This will require new registration with the Global Registry as well as new publications to trading partners to reflect the new IP GLN associated with the acquired products.</p> <p>The timing of these transactions will be negotiated between the two organisations and specified in their Transition Service agreement.</p>

25.7.3 Situation 3: New Brand Owner Retains Old Item and Publisher Numbers

These Business Scenarios all link to [GS1 Change Situation 3](#); GTINs Retained, GCP Retained, Information Provider GLN Retained and New Brand Owner GLN

Business Scenario	Business Circumstances
<p>Scenario 7: Full Acquisition / Total Company Merger: A Full Company merger with separate Item Catalogues</p>	<p>A company is entirely purchased by another company. The Acquiring company will own all products from the previous company. This includes the GTIN scheme and the GCPs previously owned by the prior company. The Acquiring company elects to keep the acquired products GTIN scheme intact and they choose to keep a separate GDSN item catalogue for these new products.</p> <p>The acquired products will continue to be published using the purchasing company's GDSN IP GLN.</p>

Business Scenario	Business Circumstances
<p>Scenario 8: Partial Divestiture/ Acquisition: A Product Range sold with a Shared GCP and future Brokerage Rights</p>	<p>A Product Range is purchased from a company whose GTIN numbering scheme consists of a GCP that will be retained by the Selling company. The new Owner has decided to engage the Seller to continue to Produce, Distribute, Market, Sell and Invoice the acquired product line. The Seller will receive a brokerage fee from the new Owner for their on-going services.</p> <p>The Divesting company has agreed to maintain the existing GTINs for the divested products and set up new items with the previous GTIN scheme (using a GLN owner by the Divesting company) as long as they continue to be contracted brokers of these products for the Acquiring company. The Divested company will continue to maintain the GDSN item catalogue for this product range.</p> <p>As a result of this contractual agreement, the only impact to the GDSN is to update the Brand Owner GLN to reflect the ownership of the Acquiring Company. This will be sent as a GTIN Change transaction to existing Trading Partners.</p> <p>If the broker relationship between the Divesting Company and the Acquiring Company is dissolved, the GTIN structure for this product range will be impacted and future GTIN number practices will need to be renegotiated at that time.</p>
<p>Scenario 9: Partial Divestiture/ Acquisition: A Product Range sold with a Unique GCP and future Brokerage Rights</p>	<p>A Product Range is purchased from a company whose GTIN numbering scheme consists of a unique GCP used exclusively for this product range. The new Owner has decided to engage the Seller to continue to Produce, Distribute, Market, Sell and Invoice the acquired product line. The Seller will receive a brokerage fee from the new Owner for their on-going services.</p> <p>The Divesting company has agreed to transfer ownership of the unique GCP to the Acquiring Company. They will inform the appropriate GS1 MO of this agreement. The Divesting company will continue to maintain and set up new GTINs using this GCP as contracted by the Acquiring company. The Divested company will continue to maintain the GDSN item catalogue for this product range.</p> <p>As a result of this contractual agreement, the only impact to the GDSN is to update the Brand Owner GLN to reflect the ownership of the Acquiring Company. This will be sent as a GTIN Change transaction to existing Trading Partners.</p> <p>If the broker relationship between the Divesting Company and the Acquiring Company is dissolved, the GTIN structure for this product range will not be impacted since the ownership of the GLN resides with the Acquiring Company.</p>

25.7.4 Situation 4: New Publisher, Data Unchanged

These Business Scenarios all link to [GS1 Change Situation 4](#); GTINs Retained, GCP Retained, New Information Provider GLN and Old Brand Owner GLN

Business Scenario	Business Circumstances
<p>Scenario 10: Licence Agreement with Full Rights: A brand agreement for a specific product line: Licensor Allocates Item Numbers</p>	<p>A company licenses the use of a brand name for an existing product family. The company will transfer the right to Produce, Distribute, Market, Sell and Modify formulas for this product line to another company in exchange for a Brand Licence fee. The Licensing Company (the Licensor) will retain ownership of the Brand name and will continue to sell other product lines (different from this line) under this same brand name.</p> <p>The Licensor has elected to allow current and future products using this Brand name for this line to maintain the existing GTIN numbering scheme. This scheme consists of a GCP that is used by the Licensor for other products that sold under this same Branding. To ensure uniqueness, the Licensor has assigned a "block" of GTINs to be used by the Licensee for new products that are developed for this line in the future. This setup results in less disruption in the supply chain.</p> <p>The Licensee will retain all previous GTINs and use of the GCP for the acquired products. The Licensee will consolidate the licensed products into their existing GDSN item catalogue. This will require new registration with the Global Registry as well as new publications to trading partners to reflect the new IP GLN associated with the acquired products.</p> <p>The Brand Owner will continue reflect the legal ownership of the Licensor.</p> <p>The timing of these GDSN transactions will be negotiated between the two organisations and specified in their Transition Service agreement.</p>

Business Scenario	Business Circumstances
<p>Scenario 11: Change in Broker/Distributor for a Product Range who maintains Item Information</p>	<p>A company contracts with a Broker/Distributor to Ship, Market and Sell products to their Trading Partners. The Broker/Distributor may play the role of an information provider and communicates Item Information and maintains GDSN communication for this product range. A change occurs in the Brokerage/Distributorship of this product range.</p> <p>Since the previous Broker/Distributor communicated and maintained Item Information via GDSN on behalf of the Brand owner, a new item catalogue will have to be set up by the new Broker/Distributor. This will require new registration with the Global Registry as well as new publications to trading partners to reflect the new IP GLN associated with the Brokered products.</p> <p>This will also require the prior Broker/Distributor organisation to remove publications for these GTINs previously published under their IP GLN and to record a discontinuation date with the Global Registry.</p> <p>The timing of these transactions will be negotiated between the two organisations and specified in their Transition Service agreement.</p>

25.7.5 Situation 5: New Arrangements with No Change of Brand Owner

This Business Scenarios links to [GS1 Change Situation 5](#); New GTINs, New GCP for GTIN Composition, New Information Provider GLN and Old Brand Owner GLN

Business Scenario	Business Circumstances
<p>Scenario 12: Licence Agreement with Full Rights: A brand agreement for a specific product line : Licensee Allocates Item Numbers</p>	<p>A company licenses the use of a brand name for an existing product family. The company will transfer the right to Produce, Distribute, Market, Sell and Modify</p> <p>Formulas for this product line are licensed to another company in exchange for a Brand Licence fee. The Licensing company (the Licensor) will retain ownership of the Brand name and will continue to sell other product lines (different from this product line) under this same brand name.</p> <ul style="list-style-type: none"> ■ The Licensor has requested the Licensee to establish a new GTIN scheme, comprised of a GCP that is owned by the new Licensee for all current and future products. This will require the Licensee to register the new GTINs with the Global Registry as well as set up publications to trading partners to reflect the new GTINs and new IP GLN associated with the licensed products. The Brand Owner will continue reflect the legal ownership of the Licensor. ■ It will also require the Licensor to remove publications for the prior, obsolete GTINs and to record a discontinuation date with the Global Registry. ■ The timing of these transactions will be negotiated between the two organisations and specified in their Transition Service agreement.

25.8 GS1 Change Situations & Steps Required

The GDSN M&A implementation steps for each of the 5 Situations are depicted below.

- **Note:** These situations apply only if both parties, the seller and buyer, are current participants in GDSN. The implementation steps required when one of the parties involved in the M&A is not a current GDSN participant will be covered in section [M&A GDSN Situation Steps – A Non GDSN User](#).
- **Note:** There could be additional steps and requirements if the parties concerned are in different data pools. Consult your data pools if you are in this situation.



25.8.1 Situation 1: Complete Change

This GS1 Change Situation corresponds to a complete new start. All identifiers will be changed to reflect the new ownership: New GTINs, New GCP for GTIN Composition, New Information Provider GLN and New Brand Owner GLN

Step	Owner	Action Step	GDSN Process		
			Message Type	Attributes Updated or Added	Timing
1	Seller	The Seller publicly announces the agreement to sell a product group to the Buyer but retains ownership of the GCP previous used in the GTIN composition for this product group	None		1st week of M&A finalisation
2	Seller & Buyer	The organisations complete a Transition Service Agreement (TSA) and communicate key facts from the Agreement to their trading partners. The TSA stipulates: The Seller agrees to provide on-going operational services for a period of 6 months The Seller may also be assigning new GTINs for the acquired products using a GCP owned by their organisation during this transition period.	None		Within 30 days of M&A announcement
3	Seller	The Seller updates the GLN of the Brand Owner on their GDSN Item Catalogue for this product group to reflect the sale of the Brand to the Buyer Note: This does not impact the Information Provider at this time. This product update is optional but it is considered a best practice.	Catalogue Item Notification (CIN)	GLN of Brand Owner Transmission Date Start Date	Within 30 days of M&A legal ownership transfer date
4	Data Recipient	The Data Recipient receives the updated Brand information from the Seller and sends an appropriate response message to the data provider Note: The Data Recipient may record this information and begin to align these products to the new brand owner or they may choose to wait until the end of the product transition period.	Catalogue Item Confirmation (CIC)	None	1 wk after receipt
5	Buyer	The Buyer begins their internal item setup process for the Acquired products. The Buyer registers new GTINs with GDSN The Buyer should ensure subscriptions exist from their Trading Partners for the Acquired product group	New Item Registration	All of the Buyer's Standard Item Attributes	Anytime during the Transition Period
6	Buyer	The Buyer launches new products with packaging displaying the ownership change and new GTINs The Buyer's business practice is to provide a minimum 60 days advance notice to trading partners of new item information	New or Initial Item Load Publication (Dependent on Trading Partner)	Transmission Date Start Date Replaces GTIN	60 Days prior to the Start Date

Step	Owner	Action Step	GDSN Process		
			Message Type	Attributes Updated or Added	Timing
7	Data Recipient	The Data Recipient records the Start Date sent to them from the Buyer and sends an appropriate response message Note: Best Practice is a response message within 30 days of the new item publication	Catalogue Item Confirmation (CIC)	None	30 days after receipt
8	Seller	Thirty days in advance, the Seller communicates to trading partners a product Non-Active Date, to signify when information for Divested products will no longer be obtainable from the Seller Note: Non-Active Date will be reflected via the GDSN End Availability Date or Last Order Date	Catalogue Item Notification (CIN)	Transmission Date Non-Active Date Replace By GTIN	30 days prior to the Non-Active Date
9	Data Recipient	The Data Recipient records the Non-Active Date sent to them from the Seller to signify the discontinuance of information for these GTINs. This may or may not trigger the need to delete a subscription for the Divested products from the Seller Note: The Data Recipient will continue to receive information for these GTINs from the Buyer as new owner (see step 7).	Subscription Delete		1 wk after receipt
10	Seller	The Seller will execute Publication Deletes for the Divested product group. This will stop communication of any information for the Divested product group with Trading Partners This does not impact communication with the Global Registry or the Seller's Data Pool.	Publication Delete	None	
11	Seller	Six months after the end of the transition period, the Seller will end the maintenance of the Divested Product Group item records in their Product Master with an established Inactive date Note: Timing of the Inactive message will vary by Information Provider.	Catalogue Item Notification (CIN)	Transmission Date Discontinue Date	Within 1 wk of setting the Non-Active Date
12	Global Registry	Global Registry will record the Inactive Date submitted by the Seller	None		Timing based on internal business practices

25.8.2 Situation 2: Changed Ownership Retains Item Numbers

This GS1 Change Situation corresponds to a complete business takeover that allows the new owner to adopt all existing item identifiers. No item identifiers will be changed, but the new owner has become the Brand Owner and also the Publisher of the information: GTINs Retained, GCP Retained, New Information Provider GLN and New Brand Owner GLN.

Step	Owner	Action Step	GDSN Process		
			Message Type	Attributes Updated or Added	Timing
1	Buyer	The Buyer publicly announces the complete acquisition of another organisation	None		1st week of agreement finalisation
2	Buyer & Seller	The Buyer and the Acquired organisation (Seller) develop a Transition Service Agreement (TSA) to stipulate interim and longer term operating practices. Key facts are communicated to trading partners.	None		Within 30 days of M&A announcement
3	Buyer	The Buyer notifies the Local GS1 Organisation of the acquisition and informs them of the company's intention with regard to future use of the acquired GCPs. The Buyer intends to retain full use of the Acquired Company's GCPs The Buyer should ensure subscriptions exist from their Trading Partners for the Acquired product group	None		Within 30 days of M&A announcement
4	Seller	The new owner has the Seller update the GLN of the Brand Owner on their GDSN Item Catalogue records to reflect the ownership change. Note: This does not impact the Information Provider at this time. This product update is optional but it is considered a best practice.	Catalogue Item Notification (CIN)	GLN of Brand Owner Transmission Date Start Date	Within 30 days of M&A legal ownership transfer date
5	Data Recipient	The Data Recipient receives the updated Brand information from the Seller and sends an appropriate response message to the data provider Note: The Data Recipient may record this information and begin to align these products to the new brand owner or they may choose to wait until the end of the product transition period.	Catalogue Item Confirmation (CIC)	None	1 wk after receipt
6	Buyer	The Buyer begins their internal business consolidations. This includes combining GDSN Item Catalogues into a single Information Provider. This requires new registration of the acquired products under the Buyer's Information Provider GLN. The Buyer updates the packaging of the acquired products to display the ownership change. The Buyer registers the old GTINs and new IP GLN with GDSN	New Item Registration	All of the Buyers Standard Item Attributes	Anytime during the Transition Period

Step	Owner	Action Step	GDSN Process		
			Message Type	Attributes Updated or Added	Timing
7	Buyer	<p>Thirty days in advance of the updated product availability, the Buyer publishes the old GTINs for acquired products to Trading Partners using their IP GLN</p> <p>Start Date normally corresponds with Supply Chain or other Business Practice timelines.</p> <p>The Buyer should ensure subscriptions exist from their Trading Partners to accept the acquired product publications</p>	New or Initial Item Load Publication (Dependent on Trading Partner)	<p>Transmission Date</p> <p>Start Date</p>	30 Days prior to the Start Date
8	Data Recipient	<p>The Data Recipient records the Start Date sent to them from the Buyer and sends an appropriate response message to the new Information Provider</p> <p>Note: Best Practice is a response message within 30 days of the new item publication</p>	Catalogue Item Confirmation (CIC)	None	30 days after receipt
9	Seller	<p>Thirty days in advance, the Seller, as directed by the Buyer, communicates to trading partners a product Inactive date to signify when information for the acquired products will no longer be obtainable from the Seller.</p> <p>Note: As the Selling Organisation was totally Acquired by the Buyer and the old GTINs will continued to be used by the new organisation, there is no need to keep historic records active under the Buyer. As a result, the Non-Active Date time frame is not used in this situation</p>	Catalogue Item Notification (CIN)	<p>Transmission Date</p> <p>Inactive Date</p>	30 days prior to the Inactive Date
10	Data Recipient	<p>The Data Recipient records the Inactive Date sent to them from the Seller to signify the discontinuance of information for these GTINs from the prior owner</p> <p>This may or may not trigger the need to delete a subscription for the Divested products from the Seller</p> <p>Note: The Data Recipient will continue to receive information for these GTINs from the Buyer as new owner (see step 7).</p>	Subscription Delete		1 wk after receipt
11	Seller	<p>The Seller will execute Publication Deletes for the Divested product group.</p> <p>This will stop communication of any information for the Divested products with Trading Partners</p> <p>This does not impact communication with the Global Registry or the Seller's Data Pool</p> <p>Note: The Buyer should also notify that Data Pool to when inactivate the Seller IP GLNs since the prior organisation will no longer be in existence</p>	Publication Delete	None	
12	Global Registry	Global Registry will record the Inactive Date submitted by the Seller	None		

25.8.3 Situation 3: New Brand Owner Retains Old Item and Publisher Numbers

This GS1 Change Situation corresponds to a change in brand ownership where the item maintenance and publication arrangements are not otherwise changed: GTINs Retained, GCP Retained, Information Provider GLN Retained and New Brand Owner GLN.

Step	Owner	Action Step	GDSN Process		
			Message Type	Attributes Updated or Added	Timing
1	Buyer	The Buyer publicly announces the complete acquisition of another organisation	None		1st week of agreement finalisation
2	Buyer & Seller	The Buyer and the Acquired organisation (the Seller) develop a Transition Service Agreement (TSA) to stipulate interim and longer term operating practices. Key facts are communicated to trading partners.	None		Within 30 days of M&A announcement
3	Buyer	The Buyer notifies the Local GS1 Organisation of the acquisition and informs them of the company's intention with regard to future use of the acquire GCPs. The Buyer intends to retain full use of the Acquired Company's GCPs The Buyer intends to retain a separate on-going GDSN Item Catalogue for the Acquired Company's products under the previous owners IP GLN	None		Within 30 days of M&A announcement
4	Seller	The new owner has the Seller update the GLN of the Brand Owner on their GDSN Item Catalogue records to reflect the ownership change. Note: This does not impact the Information Provider. This product update is optional but it is considered a best practice.	Catalogue Item Notification (CIN)	GLN of Brand Owner Transmission Date Start Date	Within 30 days of M&A legal ownership transfer date
5	Data Recipient	The Data Recipient receives the updated Brand information from the Seller and sends an appropriate response message to the data provider Note: The Data Recipient may record this information and begin to align these products to the new brand owner or they may choose to wait until the end of the product transition period.	Catalogue Item Confirmation (CIC)	None	1 wk after receipt
6	Buyer	The Buyer begins their internal business consolidations. GDSN Item Catalogues will NOT be consolidated into a single Information Provider. Therefore, no new registration of the acquired products under the Buyer's Information Provider GLN is necessary. The Buyer updates acquired products packaging to display the ownership change and these flow through the supply chain with normal Inventory turns	None		

25.8.4 Situation 4: New Publisher, Data Unchanged

This GS1 Change Situation corresponds to a change in licensing or distribution arrangements where the brand ownership is not changed. Item identifiers are controlled by the brand owner: GTINs Retained, GCP Retained, New Information Provider GLN and Old Brand Owner GLN.

Step	Owner	Action Step	GDSN Process		
			Message Type	Attributes Updated or Added	Timing
1	Brand Owner	The Company publicly announces the agreement to license the use of a brand name for an existing product family. The company will transfer the right to produce, distribute, market, sell and modify formulas for this product family to another company (the Licensee) in exchange for a Brand License fee. The licensing company (the Licensor) will retain ownership of the Brand name and will continue to sell other product lines (different from this line) under this same brand name.	None		1st week of agreement finalisation
2	Brand Owner & Licensee	The two organisations complete a legal contract and communicate key facts from the agreement to their trading partners. The Licensor has elected to allow current and future products using this Brand name for this line to maintain the existing GTIN numbering scheme. This scheme consists of a GCP that is used by the Licensor for other products that are sold under this same Branding. To ensure uniqueness, the Licensor has assigned a "block" of GTINs to be used by the Licensee for new products that are developed for this line in the future. This setup results in less disruption in the supply chain.	None		Within 30 days of M&A announcement
3	Brand Owner	Notify the Local GS1 Organisation of the Licensing Agreement and their GTIN scheme arrangement	None		Within 30 days of M&A announcement
4	Licensee	The Licensee begins their internal item setup process for the Licensed products. The Licensee registers the Old GTINs with GDSN using their IP GLN	New Item Registration	All of the Brand Owner's and Licensee's Standard Item Attributes	Anytime during the Transition Period
5	Licensee	The Licensee needs to establish an Item Catalogue for these products with their Trading Partners. Per agreement with the Brand Owner, the Licensee sets this up to coincide with new packaging changes The Licensee updates product packaging to reflect the manufacturing location change and product contact information The Licensee provides a 60 advance notice to Trading Partners of the package change and the new IP GLN for this product line. The Licensee should ensure subscriptions exist from their Trading Partners for the Licensed product line	New or Initial Item Load Publication (Dependent on Trading Partner)	Transmission Date Start Date	60 Days prior to the Start Date

Step	Owner	Action Step	GDSN Process		
			Message Type	Attributes Updated or Added	Timing
6	Data Recipient	The Data Recipient records the Start Date sent to them from the Licensee and sends an appropriate response message Note: Best Practice is a response message within 30 days of the new item publication	Catalogue Item Confirmation (CIC)	None	30 days after receipt
7	Brand Owner	Thirty days in advance, the Brand Owner communicates to trading partners a product Non-Active Date, to signify when information for Licensed products will no longer be obtainable from the Brand Owner. Note: Non-Active Date will be reflected via the GDSN End Availability Date or Last Order Date.	Catalogue Item Notification (CIN)	Transmission Date Non-Active Date	30 days prior to the Non-Active Date
8	Data Recipient	The Data Recipient records the Non-Active Date sent to them from the Brand Owner to signify the discontinuance of information for these GTINs from the Brand Owner This may or may not trigger the need to delete a subscription for these products from the Brand Owner Note: The Data Recipient will continue to receive information for these GTINs from the Buyer as new owner (see step 7).	Subscription Delete		1 wk after receipt
9	Brand Owner	The Brand Owner will execute Publication Deletes for the Licensed product line This will stop communication of any information for the Licensed product line with Trading Partners from the Brand Owner This does not impact communication with the Global Registry or the Seller's Data Pool Note: A Inactive Date will not be sent by the Brand Owner since these GTINs will remain active	Publication Delete	None	Within 1 wk of setting the Non-Active Date

25.8.5 Situation 5: New Arrangements with No Change of Brand Owner

This GS1 Change Situation corresponds to a change in licensing or distribution arrangements where the brand ownership is not changed. Item identifiers are controlled by the licensee: New GTINs, New GCP for GTIN Composition, New Information Provider GLN and Old Brand Owner GLN.

Step	Owner	Action Step	GDSN Process		
			Message Type	Attributes Updated or Added	Timing
1	Brand Owner	The Company publicly announces the agreement to license the use of a brand name for an existing product family. The company will transfer the right to produce, distribute, market, sell and modify formulas for this product family to another company (the Licensee) in exchange for a Brand License fee. The licensing company (the Licensor) will retain ownership of the Brand name and will continue to sell other product lines (different from this line) under this same brand name.	None		1st week of agreement finalisation
2	Brand Owner & Licensee	The two organisations complete a legal contract and communicate key facts from the agreement to their trading partners. The Licensor has requested the Licensee to establish a new GTIN scheme, comprised of a GPC that is owned by the new Licensee for all current and future products. The current scheme consists of a GCP that is used by the Licensor for other products that are sold under this same Branding. organisation	None		Within 30 days of M&A announcement
3	Licensee	The Licensee begins their internal item setup process for the licensed products The Licensee registers new GTINs under their IP with GDSN	New Item Registration	All of the Buyers Standard Item Attributes	Anytime during the Transition Period
4	Licensee	The Licensee launches new products with packaging displaying the Manufacturer change and updated contact information The Licensee's business practice is to provide a minimum 60 days advance notice to trading partners of new item information The Licensee should ensure subscriptions exist from their Trading Partners for the Acquired product group	New or Initial Item Load Publication (Dependent on Trading Partner)	Transmission Date Start Date Replaces GTIN	60 Days prior to the Start Date
5	Data Recipient	The Data Recipient records the Start Date sent to them from the Licensee and sends an appropriate response message Note: Best Practice is a response message within 30 days of the new item publication	Catalogue Item Confirmation (CIC)	None	30 days after receipt

Step	Owner	Action Step	GDSN Process		
			Message Type	Attributes Updated or Added	Timing
6	Brand Owner	<p>Thirty days in advance, the Brand Owner communicates to trading partners a product Non-Active Date, to signify when information for Licensed products will no longer be obtainable from the Brand Owner.</p> <p>Note: Non-Active Date will be reflected via the GDSN End Availability Date or Last Order Date.</p>	Catalogue Item Notification (CIN)	Transmission Date Non-Active Date	30 days prior to the Non-Active Date
7	Data Recipient	<p>The Data Recipient records the Non-Active Date sent to them from the Brand Owner to signify the discontinuance of information for these GTINs from the Brand Owner</p> <p>This may or may not trigger the need to delete a subscription for these products from the Brand Owner</p> <p>Note: The Data Recipient will align the end date with their internal item record maintenance policy for products discontinue for sale by a specific manufacturer</p>	Subscription Delete		1 wk after receipt
8	Brand Owner	<p>The Brand Owner will execute Publication Deletes for the Licensed product line</p> <p>This will stop communication of any information for the Licensed product line with Trading Partners from the Brand Owner</p> <p>This does not impact communication with the Global Registry or the Seller's Data Pool</p> <p>Note: A Inactive Date will not be sent by the Brand Owner since these GTINs will remain active</p>	Publication Delete	None	Within 1 wk of setting the Non-Active Date
9	Brand Owner	<p>Six months after the end of the transition period, the Brand Owner will end the maintenance of the Licensed Product line's prior GTIN item records in their Product Master with an established Inactive date</p> <p>Note: Timing of the Inactive message will vary by Information Provider.</p>	Catalogue Item Notification (CIN)	Transmission Date Inactive Date	Timing based on internal business practices
10	Global Registry	Global Registry will record the Inactive Date submitted by the Brand Owner	None		

25.8.6 M&A GDSN Situation Steps – A Non GDSN User

The standard set of GDSN M&A Situation Steps can not apply to a M&A if either the Buyer or Seller, or the Licensee or Licensor **is not** a GDSN user. The impact to a GDSN Item catalogue is simplified if this is the situation.

- **Note:** The same business processes (best practices) should be followed; however, for any participant who is NOT using GDSN, the information will be exchanged using methods other than the GDSN.

The General rules if a Non GDSN User is involved in the M&A are:

- If the Buyer or Licensee is a GDSN user but the Seller or Licensor is not a GDSN user, the Buyer or Licensee will publish the GTINs as part of their normal GDSN Item process.
 - Setup procedures and timing will follow the organisation’s normal GDSN item procedures
- If the Buyer or Licensee is not a GDSN user but the Seller or Licensor is a GDSN user, the M&A will result in the discontinuation of these products in GDSN.
 - The removal or discontinuation of these products from GDSN would remain the responsibility of the Seller or Licensor.
 - The Seller or Licensor would need to implement Publication Delete) messages for all impacted GTIN and record an appropriate item Non-Active and/or Inactive date, as per the organisation’s standard procedures for discontinuing a product.

25.9 Retailer M&A Best Practices

When a seller notifies a buyer/ Data Recipient of a M&A, and one or both parties are participating in the GDSN, the department(s) responsible for the GDSN should also receive notification. The scope (business scenario, key facts, etc.) and timeline of events should be included in this notification. For a successful transition, it is important for the Data Recipient to ensure changes are reflected within their internal systems at the appropriate time. Failure to implement M&A changes could result in synchronisation from data sources that no longer own, sell and maintain products.

There are five M&A business situations:

- Situation 1: Complete Change
- Situation 2: Changed Ownership Retains Item Numbers
- Situation 3: New Brand Owner Retains Old Item and Publisher Numbers
- Situation 4: New Publisher, Data Unchanged
- Situation 5: New Arrangements with No Change of Brand Owner

The details for each situation are covered in section [25.7](#) with steps to complete the M&A in section [25.8](#). If a party of the M&A is not a GDSN participant, information is provided in section [M&A GDSN Situation Steps – A Non GDSN User](#)

Because of the complexity of each M&A and the diversity of each Data Recipient’s system, communication to the seller and buyer regarding expectations and system/process capabilities and limitations within the GDSN are required for each situation. Some suggested topics to address include:

- What M&A scenario is occurring?
- What is the timeline, scope and step to complete the event?
- What events should occur within and outside of GDSN? For example, contracts, insurance, etc.
- How are CIN messages being used with the organisation?
- Are attribute values such as Dates, Brand Owner, etc. recognised within a CIN message so action(s) can occur?
- Is a Publication Delete required to stop item synchronisation?

- Should a CIC Reject message be sent to stop synchronisation?
- Are CIC messages sent?
- Are new subscriptions required and if so, what is the timing?
- Is a CIN message required to set up a new item?
- Is a name change required for an existing GLN?

25.10 Other Useful Information

Please see following resources for more information:

- GDSN Product Hierarchy Common Values Spread sheet
- Dates

26 Repeatability of Modules

26.1 General Remarks

There are some modules in GDSN that allow the data source to publish more than one set of information. For example, there may be several product characteristics associated with a Trade Item, and the Product Characteristics Module has a data structure which allows for multiple characteristics to be sent in a single instance of the extension.

Some other GDSN modules do not allow for more than one set of information. Occasionally, this can be an issue for data sources and data pools if there is a business need for sending more than one set of information. In this instance it would be necessary to publish the entire module more than once (repeatability).

27 Business to Government (B2G)

The purpose of this section is to provide guidance to Suppliers, GDSN Data Pools and Governmental Agencies on how to utilise GDSN to pass product information from the Supplier to Governmental Agencies responsible for admitting cargo at international borders.

Governmental Agencies can benefit from the availability of authoritative, structured, globally relevant product information to facilitate product admission at international borders. This product information would be utilised to more efficiently recognise repetitive, low-risk products, evaluate risks of low-volume products, and ideally release all or most products in advance of arrival. Optionally, some Governmental Agencies may use the data in collaboration with suppliers to assist in detecting shipments of counterfeit products as violations of intellectual property rights. The Global Data Synchronisation Network (GDSN) has the ability to assist in providing the information needed to these Governmental Agencies.

The GDSN has the ability to provide product information electronically from the supplier of the item to a recipient. While this information is traditionally supply chain logistical data, a subset of these data elements describe or classify products and satisfy the government use case. Governmental Agencies would become new recipients of GDSN data. Governmental Agencies would access GDSN information via a GDSN Data Pool about products of common interest to regulatory Agencies to make this information available to targeting systems. Importers would include the Global Trade Item Number (GTIN) of imported products in the electronic entry information they file with the government, and the government would use the GTIN submitted in the entry to access related structured GDSN product information on file as an input to their targeting systems. Those products with low risk profiles could then be released in advance of arrival, when possible, without physical inspection. If not found to be of sufficiently low risk, importers would instead have advance notice of required holds and be able to plan accordingly.

For this use case to be made functional, there are a few challenges which need to be resolved to provide the ease of use needed for suppliers and Governmental Agencies to readily adopt this

solution. These challenges are not hard to overcome. This use case will outline those challenges and identify appropriate resolutions for them.

- **Note:** This topic provides guidance (not standards) for trading partners to gain a better understanding of the use of GDSN by Governmental Agencies. Each agency has the ability to specify the attributes which will support its own processes and programs.

27.1 Who Will Use this?

This guidance should be used by the following types of organisations:

- **Supplier** - This actor is the supplier of product information. The supplier may be the actual manufacturer, brand owner, or a supplier/importer of the item. For the Agencies, this actor would be the manufacturer and/or brand owner that oversees product creation and is responsible for placing it into the supply chain, as they know the product best. For some items, such as private-label retail products, the private label brand owner may have to publish the data through the GDSN to have their items available to Governmental Agencies.
- **GDSN Certified Data Pool (Data Pool)** - This is the technology provider who operates a solution whereby product information is shared using the GDSN standards. This actor role would have service contracts with the Suppliers and Agencies.
- **Note:** Some data pools are operated by a GS1 Member Organisation (MO) and others are not. There is no functional difference between GDSN data pools with or without a GS1 member organisation association.
- **Governmental Agencies (Agencies)** - These are the recipients of the product information in the government area. These Agencies are recognisable as a part of an official government body. The primary intent of this guidance is aimed at Federal or National governments, but is not limited to these. Local level Governmental Agencies might find similar uses for this information and might utilise GDSN messaging as defined in this guidance.
- **Note:** Governmental Agencies will receive product information data files and, depending on the Data Pool selected, may also be able to access GDSN product information published/available to them by ad hoc query using a web-screen. This document assumes that Governmental Agencies will use data files to ensure that a local product data repository remains highly available to government targeting systems.
- **Business to Government Recipient** - This actor is a party who is receiving product information via GDSN. Under this use case, the recipient is typically a Governmental Agency.

27.2 Implementation Procedures

For this use case to be functional, there are a few challenges that need to be resolved to provide the ease of use expected by suppliers and Governmental Agencies. These challenges are not hard to overcome; their challenges and resolutions are outlined here.

The first challenge is to help the Governmental Agencies in the subscription process. GDSN requires that recipients enter subscriptions to acquire access to the publications. The options for creating subscriptions are by GTIN, GPC, GLN, Target Market (TM) or a combination of these. The following are the challenges of each type of Subscriptions.

- **Subscription by GTIN** - The Agencies will not have advanced notice of a GTIN. Typically they find a new product when it is presented at the border for entry into the country. This type of subscription would not be effective for this use case.
- **Subscription by GLN** - The Agencies would need to know what companies would be presenting items to be able to subscribe at this level. Similar to the GTIN approach, with new companies starting each day, the agency may not know of a company until an item is presented for entry.

- **Subscription by Target Market (TM)** - This subscription is important but not in isolation. A TM subscription would help to ensure that the agency receives GTINs for products intended for distribution in their country, but agency missions are focused on a specific set of product categories (for example, on medical products or food products). Using TM in combination with the GPC subscription type might be useful, but not as currently implemented.
- **Subscription by GPC** - This subscription is important but, as implemented, includes a major limitation for the Agencies. Currently each subscription is limited to a single value at the GPC Brick level. The level of effort required to create and maintain hundreds or thousands of subscriptions to ensure information were received on all products of interest would, in most cases, be overwhelming to the Agencies.

The second challenge for Governmental Agencies is to ensure they can get all products that match their subscriptions. Current GDSN processes require the supplier of data to publish their items privately to specific GLNs or as a public item for any GLN. Any public publications would match any subscription from the Agencies causing the product information to be fulfilled. However, the majority of publications have been published privately, which does cause a challenge for the Agencies to get the data that they need.

The third challenge is to provide a list of the attributes that would be shared with the Governmental Agencies. The Agencies do not need the bulk of the attributes being populated in GDSN. The Agencies are primarily interested in attributes which identify the product, description, classification, manufacturer, country or countries of origin, and product images. Other attributes such as marketing, nutrition, hazardous material, and product dimensions are optional for this use case.

27.2.1 How would Governmental Agencies subscribe to GDSN Product Information?

The Agencies would enter subscription data into their Recipient Data Pool. The agency would submit their subscriptions, typically specifying the Target Market and the GPC Class. This would be entered using a Data Pool tool. Once the information is received, the tool could either automatically or manually create the initial subscriptions in the format needed by the GDSN Global Registry (GR).

A Data Pool that has or anticipates having an agency as a customer would need to support an agency's subscriptions at the GPC Class level. From the agency's subscription, appropriate subscriptions to the GR at the GPC Brick level would be submitted. Note that there would be a need to manage GPC Changes that affect GPC Class to Brick mapping over time.

- **Note:** Governmental Agencies would be subject to normal subscription fees of the GDSN data pool. All GDSN-compliant data pools will provide access to all products published in that same or another GDSN-compliant data pool, so data pool selection will not limit access to product data. Data pools will use normal publication/subscription services for suppliers to send data to governments.
- **Note:** Governmental Agencies have the option to use the current GDS subscription types if they choose to.

27.2.1.1 Pre-Requisite

The Data Pools should develop a subscription tool for the Agencies under this use case. It would be difficult for the Agencies to manage multiple thousands of subscriptions at the brick level once completely built out, as GPC has over 3,500 bricks as of 2012. But Agencies could manage the significantly smaller set of GPC Class levels important for them (GPC Class is the level immediately above the brick about 900 as of 2012). Subscriptions at the class level would be easier to manage over time as that level is relatively stable from one GPC publication to the next.

The agency would need to understand the data attributes available in the GDSN, and in particular, the Global Product Classification (GPC) brick code and brick code attributes. Agencies would need to have the ability to detail the list of classes for which they wish to receive product information. The recipient Data Pool who has an agency as a customer would need to build a "tool" whereby the agency could submit subscriptions at this GPC Class level. Once the tool has the subscription classes loaded, the tool would manage and submit appropriate subscriptions to the GR at the GPC Brick level.

27.2.1.2 When Would I Use This?

An agency would use the Class Level Subscription Tool to provide subscription classes to their data pool when they are ready to receive product information from the GDSN. This level of readiness would be determined by the agency through its adoption of GDSN. This adoption would require choosing and contracting with a GDSN data pool, developing a method and process through which GDSN product information can be accepted and utilised, and communication with the agency’s target trade community about their desire and process for using GDSN. Once a government has established a subscription at the Class level, all new products published for the matching bricks and to the agency would automatically be made available to that government through this Business-to-Government (B2G) data synchronisation process.

27.2.1.3 How Would the Tool Work?

The Class Level Subscription tool would be a value-added service provided by the data pools. The look and feel of the tool will vary from one data pool to the next based on the systems and programs they use to develop the tool. The tool should be simple and not overly complicated. Basic information that should be included in the tool is:

- **Agency’s Global Location Number (GLN)** - The agency submitting the subscription, this will also be the GLN used by source data pools as they publish to the recipient’s GLN.
- **Global Product Classification (GPC) Class for subscription** - These would be the GPC classes for which product information is requested. Multiple class values should be supported.
- **Target Market** - The target market of interest to the Governmental Agency, which would typically be the market to which the country of the Governmental Agency belongs.
- **A subscription identifier or document number** - This would be an identification number associated with the subscription being submitted, distinguishing it from other subscriptions.

The tool will also need the ability to allow changes and amendments over time. These changes would include adding classes to the subscription, and removing classes from the subscription.

The GDSN data pools operating the tools will need to map the GPC class to the GPC Brick using the full GPC code set fields found at the [GPC Website](#) (see [Figure 27-1](#)). Then using these bricks, the data pool would create GDSN Catalogue Item Subscription (CIS) messages according to the current GDSN Standards. The CIS would be sent to the GS1 Global Registry® for processing.

The data pool will also need to develop a process for managing changes from one publication of GPC to the next as they are deployed in GDSN.

Figure 27-1 Diagram of the Subscription Process

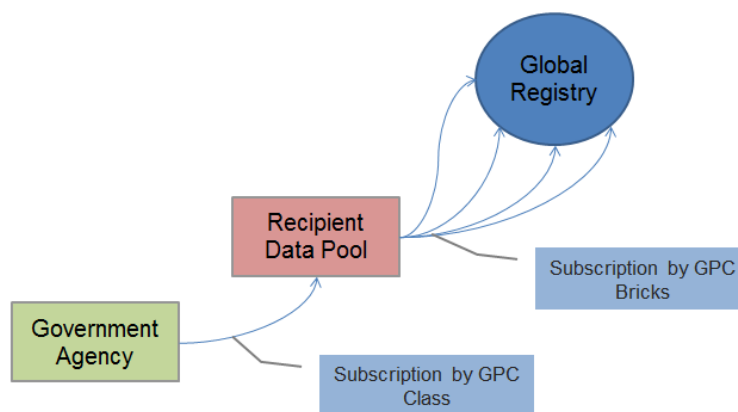

27.2.2 How is product information published to the Governmental Agency?

Governmental Agencies will need to obtain information for all products which match their subscriptions. Current GDSN processes require the supplier of data to publish their items privately to specific recipient GLNs or as a public item for any GLN (see [Figure 27-1](#)). Any public publications which match any subscription from the Agencies will cause the product information to be fulfilled.

However, the majority of publications have been published privately, which does cause a challenge for the Agencies to get the data that they need.

To overcome this challenge, the Agencies and their data pool partner will need to work together to inform the Supplier community of the Agencies’ intent to obtain product information through GDSN. Part of this communication, which is external to GDSN, would be to explain the benefits to the Supplier for providing product information using the GDSN.

The Supplier would need to add the Agencies’ GLN to the product publications. Once this is accomplished, all product information matching an agency’s subscription would be published from the source data pool to the agency (through the Agency’s recipient data pool). The Agency can then begin to use the information as needed.

The benefits of publishing to the Agency can be, but is not limited to, the expedited border release of commonly traded, low risk products when imported by the supplier or their customers. However, it is up to the Supplier to determine their desire to participate. By choosing not to publish to an Agency, the Supplier understands that the Agencies will not have access to GDSN product information to facilitate the product release process.

The choice of whether multiple Agencies of the same government wish to have their own subscription or if all Agencies of one government share one subscription is a decision for each government. Both models can be supported, and arguably, although the latter is more efficient, it may create local performance issues if data has to be further replicated to multiple targeting systems.

27.2.2.1 Pre-Requisite

The pre-requisite is that a Supplier has an item registered in the GDSN Global Registry and determines to publish the item to a Governmental Agency. The Governmental Agency would need a subscription which matches the publication. If so, the data pool would publish the Catalogue Item Notification (CIN) for the matching product hierarchy to the Governmental Agency.

27.2.2.2 When Would I Use This?

This would be used for all items which are registered at the data pool and for which there is a benefit for synchronising with the Governmental Agency.

27.2.2.3 How would the Data be sent to the Agency?

The recipient data pool for Governmental Agencies would need to provide a subscription as noted in the previous section. The Agencies will need to provide communications with the assistance of their recipient data pools instructing Suppliers on how to send product information to the Agency using the GDSN. This information should include the benefits gained by the Agency and the Supplier for having synchronised data.

With this information the Supplier can make a decision on sending data to the agency using GDSN. If they utilise the GDSN, product information which matches the Agencies’ subscriptions will be forwarded using the standard GDSN methodology.

Figure 27-2 Diagram of the publication process

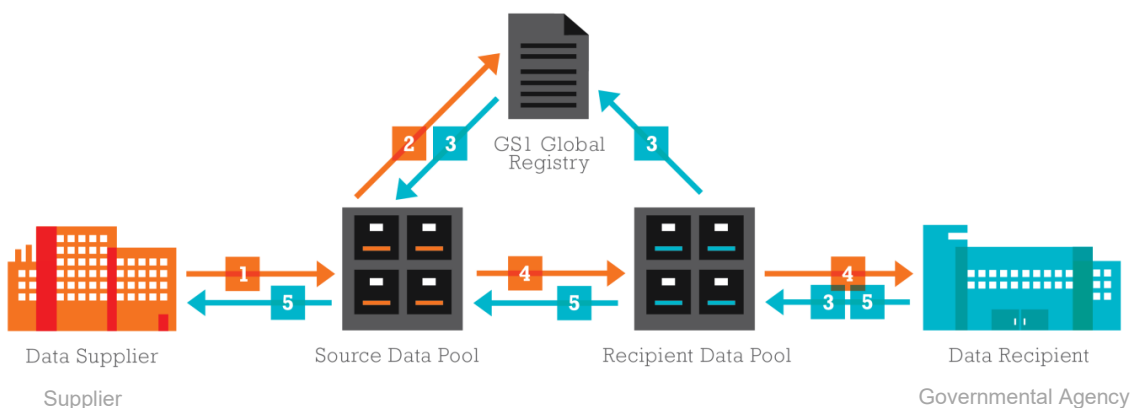

27.2.3 What attributes are needed to support the B2G process?

The Governmental Agencies will need a set of information for their processing of items, such as when the item crosses borders. This information is a subset of the information normally available through the GDSN B2B process. GDSN has a large set of attributes which can provide a very robust picture of an item. However, most of this information may not be useful in governmental applications.

Agencies receiving product information from Suppliers through the GDSN will clearly benefit from having access to basic attributes such as the product GTIN, product name, brand owner name, description, GPC classification brick and GPC attributes, manufacturer, country or countries of origin, and product images. Other sets of attributes may provide additional benefits or provide assistance in other processes, such as those attributes in areas like marketing, nutrition, hazardous materials, and product dimensions. This document is a guideline for use and is not fully inclusive of all programs, processes or agency needs.

27.2.3.1 Pre-Requisite

An item needs to be published to the Agency using a certified GDSN data pool and the Agency has a matching subscription.

27.2.3.2 When Would I Use This?

The following list is a basic set of information which might prove useful to an agency; however other attributes may be requested or used for different processes under taken by an agency. These other attributes will be communicated directly from the agency needing them.

27.2.3.3 What Attributes will be shared?

The following sections describe several sets of attributes that will be provided as mandatory for the GDSN message or as examples of data which can be used. The full set of actual attributes requested by an agency (as spelled out in their community documentation) would be drawn from the CIN received from the source data pool. The recipient Data Pool will have a process to pass the Supplier’s CIN attributes across to the Agency. This will ensure that each Agency receives the attributes relevant to the product.

It should be understood that for any publication and agency request, the more robust the product information is, the more use the Agency will derive from it. No messages will be refused/rejected by the Agency for missing values. However, the more missing values, the more difficult it may be for the Agency to understand the product and to include in any process or programs which use this type of product information.

Governmental Agencies must understand the existing definitions of data attributes, such as **tradeItemCountryOfOrigin**, and if functionality or attributes are needed over and above what is available in GDSN, work through the GDSN change request process to make appropriate revisions.

27.2.3.4 Legend

B2G Requirements	Definition
GDSN Mandatory	These attributes are mandatory or core attributes for the GDSN Message. A message cannot be published without these elements.
Optional	These attributes, while not required for a well formed GDSN message, add value to the product information supplied for the trade item. If available and applicable, population of value for these attributes would aid in the Agencies programs and processes. Without this information, items may not be handled via an automated or expedited fashion and not get the full advantage of the agency’s processes or programs.

27.2.3.5 GDSN Mandatory Attributes

The following is a list of the GDSN Mandatory attributes which are most applicable to the agency programs known at the time of publication of this document. There may be other GDSN mandatory attributes which can provide benefit to an agency. It will be up to the agency to detail those additional attributes in its community communications. These attributes, by being required to be sent for a well formed GDSN message to be published, will provide some basic information about the product for the agency.

Table 27-1 Basic GDSN Mandatory Attribute List for use by Governmental Agencies

Attribute Name	Definition	B2G Requirements
globalTradeItemNumber	See GS1 Navigator, GDSN for the latest definition.	GDSN Mandatory
informationProviderOfTradeItem/gln	The party providing the information about the trade item. Also see GS1 Navigator, GDSN.	GDSN Mandatory
informationProviderOfTradeItem/partyName	See GS1 Navigator, GDSN for the latest definition.	GDSN Mandatory
targetMarketCountryCode	See GS1 Navigator, GDSN for the latest definition.	GDSN Mandatory
gpcCategoryCode *	See GS1 Navigator, GDSN for the latest definition.	GDSN Mandatory
tradeItemUnitDescriptor	See GS1 Navigator, GDSN for the latest definition.	GDSN Mandatory
isTradeItemABaseUnit	See GS1 Navigator, GDSN for the latest definition.	GDSN Mandatory
totalQuantityOfNextLowerLevelTradeItem	See GS1 Navigator, GDSN for the latest definition.	GDSN Mandatory
quantityOfChildren	See GS1 Navigator, GDSN for the latest definition.	GDSN Mandatory
quantityofNextLowerLevelTradeItem	See GS1 Navigator, GDSN for the latest definition.	GDSN Mandatory
brandName	See GS1 Navigator, GDSN for the latest definition.	GDSN Mandatory
effectiveDateTime	See GS1 Navigator, GDSN for the latest definition.	GDSN Mandatory
publicationDateTime	See GS1 Navigator, GDSN for the latest definition.	GDSN Mandatory
lastChangeDateTime	See GS1 Navigator, GDSN for the latest definition.	GDSN Mandatory
startAvailabilityDateTime	See GS1 Navigator, GDSN for the latest definition.	GDSN Mandatory

* The Global Product Classification (GPC), Import Classification, and Additional Classifications (such as UNSPSC or eCI@ss) provide various different levels of information which is used to help categorise an item for Agencies. While each can provide clarity on their own, the combination of the GPC, Import Classification, and specifically UNSPSC provides a greater level of clarity and understanding as to what an item is.

27.2.3.6 Optional Attribute Groups

The following is a list of optional attribute groupings which can provide a benefit to Governmental Agencies known at the time of this publication. There may be other optional attribute groupings which can provide benefit to an agency. It will be up to the agency to detail those additional attributes in its community communications.

- Hazardous Material/Chemical Ingredient Attribute Sets – For chemical and dangerous goods products
- Food and Beverage Extension Attribute Set – For consumer-packaged Food and Beverage products
- Healthcare Extension Attribute Set – For pharmaceutical and medical device products

- Chemical Ingredient Extension Attribute Set - For reporting of chemicals of concern when contained in a product
- Image/External File/Meta Data Attribute Set – To provide links to images or other external files to help provide clarity about an item
- Certification Attribute Set – For certifications obtained by the item for its production, or capabilities

27.2.3.7 Optional Attribute Example

The following attribute set is an example of information that may be requested by a Governmental Agency when these attributes provide supplemental value to understanding product risk. The inclusion of these attributes in an agency CIN request will depend on the type of product (e.g., food and beverage, healthcare, chemicals) and the mission of that agency. This example is to illustrate those attributes which might be beneficial to a Governmental Agency for use at border crossing. The attributes listed below are in addition to the GDSN Mandatory listed in Section [27.2.3.5](#).

Table 27-2 Optional Attributes

Attribute Name	Definition	B2G Requirements	B2G Rationale
classificationCategoryName gpcCategoryName	See GS1 Navigator, GDSN for the latest definition.	Optional	Provides the GPC Brick Name. Most Data Pools automatically pass this information
gpcAttributeTypeCode	See the GS1 Navigator, GDSN for the latest definition.	Optional	GPC attributes will help to provide more detail about the item and will help to readily identify it as it is reviewed by the agency
gpcAttributeTypeName	See GS1 Navigator, GDSN for the latest definition.	Optional	
gpcAttributeValueCode	See GS1 Navigator, GDSN for the latest definition.	Optional	
gpcAttributeValueName	See GS1 Navigator, GDSN for the latest definition.	Optional	
additionalTradeItemClassificationSystemCode	See GS1 Navigator, GDSN for the latest definition.	Optional	Additional Classification Systems help to provide more clarity as to the item, such as UNSPC, eCI@ss, and GMDN. In particular, UNSPSC is a recommended classification to provide for US Customs as they have built look ups and references to that system.
additionalTradeItemClassificationCodeValue*	See GS1 Navigator, GDSN for the latest definition.	Optional	
additionalTradeItemClassificationVersion	See GS1 Navigator, GDSN for the latest definition.	Optional	
additionalTradeItemClassificationCodeDescription	See GS1 Navigator, GDSN for the latest definition.	Optional	
importClassificationType	See GS1 Navigator, GDSN for the latest definition.	Optional	Providing the import classification system values for the target market will help to reference the item to its corresponding tariff and duty codes.
importClassificationValue*	See GS1 Navigator, GDSN for the latest definition.	Optional	
countryOfActivity	The geographic area where an activity has taken place. See GS1 Navigator, GDSN.	Optional	Information as to the country where certain processes or activities which the item has undergone will help to provide The ability to match the item against country watch lists.
countryOfOriginStatement	See GS1 Navigator, GDSN for the latest definition.	Optional	
manufacturer	Party name and identification information for the manufacturer of the trade item. See GS1 Navigator, GDSN.	Optional	This should be the company which is in control of the manufacturing process.
manufacturerOfTradeItem/partyName	See GS1 Navigator, GDSN for the latest definition.	Optional	

Attribute Name	Definition	B2G Requirements	B2G Rationale
cancelledDateTime	See GS1 Navigator, GDSN for the latest definition.	Optional	Dates are helpful to backend systems for the understanding of the item's status and applicability of its information.
discontinuedDateTime	See GS1 Navigator, GDSN for the latest definition.	Optional	
endAvailabilityDateTime	See GS1 Navigator, GDSN for the latest definition.	Optional	
descriptionShort	See GS1 Navigator, GDSN for the latest definition.	Optional	Description fields help the agency to understand the name of the item and may provide clarity to aid in processing the item.
text (AdditionalTradeItemDescription)	See GS1 Navigator, GDSN for the latest definition.	Optional	
subBrand	See GS1 Navigator, GDSN for the latest definition.	Optional	Additional Brand information which might help to identify the product.
languageSpecificBrandName	See GS1 Navigator, GDSN for the latest definition.	Optional	
languageSpecificSubBrandName	See GS1 Navigator, GDSN for the latest definition.	Optional	
certificationAgency	See GS1 Navigator, GDSN for the latest definition.	Optional	Certifications provide the ability to identify other organisations which have standards, business/manufacturing process steps, or raw material requirements which impact the item, and can help to evaluate the item.
certificationStandard	See GS1 Navigator, GDSN for the latest definition.	Optional	
certificationValue	See GS1 Navigator, GDSN for the latest definition.	Optional	
certificationEffectiveEndDateTime	See GS1 Navigator, GDSN for the latest definition.	Optional	
certificationEffectiveStartDateTime	See GS1 Navigator, GDSN for the latest definition.	Optional	
_ReferencedFileTypeCode	See GS1 Navigator, GDSN for the latest definition.	Optional	Providing at least one marketing image of the front face of item will assist the agency should they need to review the physical product or to help understand what the product is. Use of the GDSN Image Standard is recommended.
uniformResourceIdentifier	See GS1 Navigator, GDSN for the latest definition.	Optional	
fileName	See GS1 Navigator, GDSN for the latest definition.	Optional	
fileFormatName	See GS1 Navigator, GDSN for the latest definition.	Optional	
fileFormatDescription	See GS1 Navigator, GDSN for the latest definition.	Optional	
fileEffectiveStartDateTime	See GS1 Navigator, GDSN for the latest definition.	Optional	
fileEffectiveEndDateTime	See GS1 Navigator, GDSN for the latest definition.	Optional	
isTradeItemShippedInMultipleContainers	See GS1 Navigator, GDSN for the latest definition.	Optional	
packagingTypeCode	See GS1 Navigator, GDSN for the latest definition.	Optional	
packagingTypeDescription	See GS1 Navigator, GDSN for the latest definition.	Optional	Packaging information adds value where certain materials are on a watch or exclusion list.

Attribute Name	Definition	B2G Requirements	B2G Rationale
packagingFunctionCode	See GS1 Navigator, GDSN for the latest definition.	Optional	
packagingMaterialTypeCode	See GS1 Navigator, GDSN for the latest definition.	Optional	

* The GPC, Import Classification, and Additional Classifications (such as UNSPSC or eCI@ss) provide various different levels of information which is used to help categorise an item for Agencies. While each can provide clarity on their own, the combination of the GPC, Import Classification, and specifically UNSPSC provides a greater level of clarity and understanding as to what an item is.

28 Packaging Sustainability

This section provides implementation guidance on Packaging Sustainability. The scope is the data and processes for the introduction of metrics from the **Global Protocol of Packaging Sustainability (GPPS 2.0)** within the GDSN.

For this issue of the implementation guide, the scope is limited to a few high priority topics which have been identified by the GDSN Business Requirements Group as sources of confusion. It is intended that future versions will expand the scope to cover additional topics that require detailed explanation and examples related to GPPS 2.0 in GDSN.

If information is sought about a procedure or attribute not yet covered by the guide, users should see [BMS Trade Item Modules Library in the section on the Packaging Sustainability Module](#). + If you need additional training or advice please contact your solution provider, data pool, or GS1 member organisation (MO).

28.1.1 General Considerations

28.1.1.1 How to select metrics

In a packaging development context the selection of metrics to be used when a change is made to packaging will depend heavily on the type of change which is made. For a simple reduction of the weight of, for example a bottle, without changing the material, the weight reduction of the material in question may be enough in order to conclude that an environmental saving is made. In other cases, for example when the weight of one material in the packaging system is reduced whereas the weight of another material is increased, then a wider set of metrics may be required.

If the information is used for decision making in a business-to-business context such as the one represented by the GDSN platform the set of indicators entered into the system would typically be the result of a dialogue between the information provider and the company reviewing the information. As a general rule, LCA metrics will give more reliable information on the environmental performance of the packaging system.

The following example describes a retailer and brand owner dialogue regarding packaging design and potential environmental benefits for a salad dressing PET bottle with PP cap, PET label and 12 bottles per case. Three potential changes to the bottle are discussed: reducing bottle weight, a design change in the bottle and a smaller shipper, a renewable source of PET which hypothetically is from algae.

Figure 28-1 Packaging Design Retailer and Brand Owner Dialogue

	Current Package	Scenario #1	Scenario #2	Scenario #3
Specification Change		Lightweight	Redesign	New PET source
PET Bottle	40 g.	36 g.	36 g.	40 g.
Shipper	20 g.	20 g.	18 g.	20 g.
Cube Utilization	55%	55%	60%	55%
PET Source				AFRICAN ALGAE
Visible Change to Consumer		No	Yes	No

BUSINESS QUESTION:
 What is the benefit of 10% less PET in bottle
 • Bottle – 40 g (control), 36 g (proposed)

Metric	Control	Proposed
Packaging weight and minimization	67 g	63 g 6% less packaging
Packaging to product (16 oz) weight ratio	14.7%	13.9%



BUSINESS QUESTION:
 What is the benefit of 10% less PET, still 16 oz. product - smaller shipper
 • Bottle – 40 g (control), 36 g (proposed)
 • Shipper – 220 g / 12 bottles

Metric	Control	Proposed
Packaging weight and minimization	67 g.	61 g. 10% less packaging
Packaging to product (16 oz) weight ratio	14.7%	13.4%
Cube Utilization	55%	60%
Carbon footprint ???		



No material reduction
No design change
Just a different source for PET

- **Environmental Indicators**
 1. Renewable content
 2. Material waste
 3. Chain of custody
 4. Toxicants concentration
 5. Water from stressed resources
 6. Environmental management system
 7. Energy audits
- **Life Cycle Indicators**
 - All life cycle metrics (14) - LCA
- **Economic Indicators** (any project)
 - Total cost of packaging
 - Packaged product wastage
- **Social Indicators**
 - All social metrics (13) - checklist



In this case the business partners decided that two metrics were enough to conclude whether there is an environmental benefit in reducing the weight of the bottle. A re-design of the bottle to reduce weight as well as improving cube utilisation in transport was found to require three indicators, whereas a more complex change to a completely new material with a less known supply chain was found to require a set of 36 indicators drawn from all the different indicator sets recommended in GPPS 2.0.

In the course of the work on GPPS 2.0, a tool named PackCheck was developed to give guidance to GPPS 2.0 users on how to select metrics depending on the context. PackCheck can be downloaded from The Consumer Goods Forum Website at this [link](#).

A series of additional tutorials for using the tool is available on YouTube at the following links:

- Start 1:03 <http://youtu.be/f5URZe-N-Zc>
- Intro 1:21 <http://youtu.be/IUApSfKldc0>
- Select 1:28 <http://youtu.be/i6ezRkIY5Bk>
- Evaluate 1:51 <http://youtu.be/INL7QPF2Abo>
- Show 2:42 <http://youtu.be/z5Ocz1Dmbwk>
- Case, part 1 2:57 <http://youtu.be/dothSrNFJdE>
- Case, part 2 4:16 http://youtu.be/npaKV_X-kD0

Further information on how to select and communicate metrics can be found in the GPPS 2.0 document available for download at on the project website <http://globalpackaging.mycgforum.com/>.

28.1.1.2 Packaging levels in GPPS vs. GDSN

The following section explains the differences between the nomenclatures in GPPS 2.0 as compared to the nomenclature under GDSN.

Figure 28-2 Packaging Levels Example

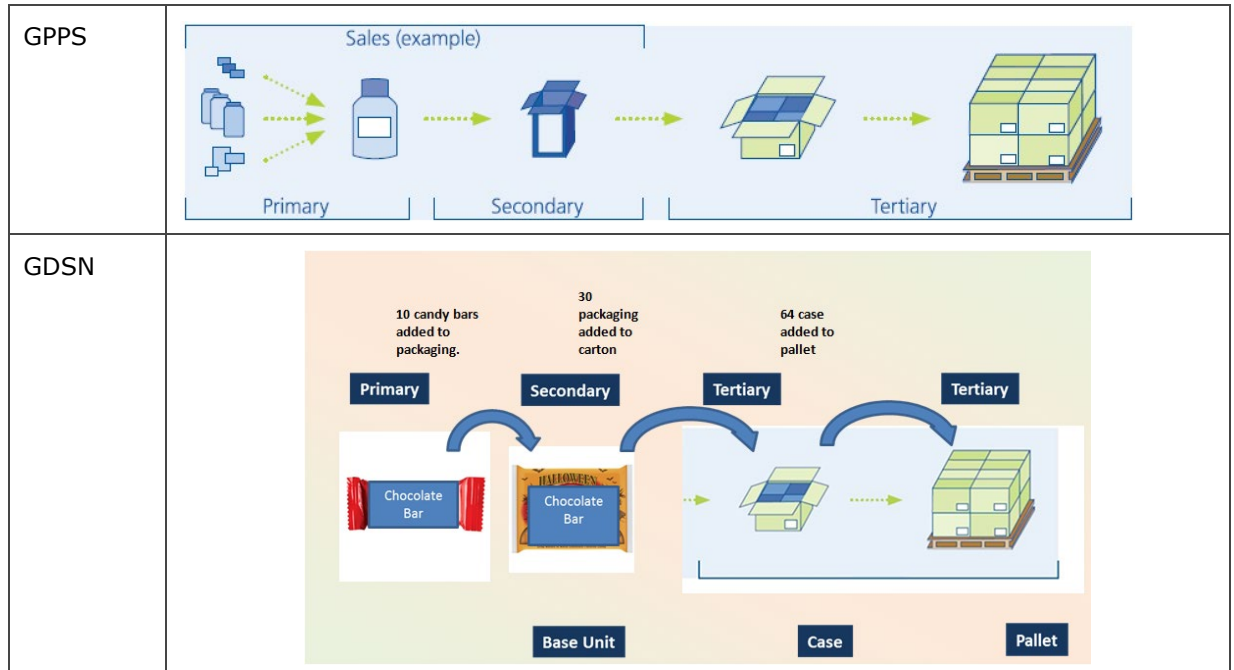

28.1.1.3 Functional Unit (FU)

GPPS 2.0 gives a thorough description of how to develop a functional unit as the quantified performance of a product system of packaging for use as a reference unit in a LCA study. The functional unit should reflect the packaging performance, which is linked to the packed product. For a brand-owner or a retailer a typical functional unit could be per serving in the case of a food product, and in the case of a detergent per washing cycle or per weight of clothes washed. In such cases the functional unit reflects all the reference flows required to deliver the functional unit to the end user.

Sector specific implementation guidelines may be made available by industry sectors where relevant, for example for sectors where products providing the same function are present in various formats. A typical sector of this kind is detergents, where a detergent can be sold as a more or less concentrated liquid, as tablets, as well as in the form of powders, each one providing a certain number of washing cycles per unit weight delivered. In the absence of such guidance, the default functional unit in GDSN will be the pallet. If the product is not delivered on a pallet, then the functional unit should be the highest available level below the pallet level.

28.1.1.4 Unit of measure

Implementers of this standard are recommended to select one single unit to be used for all data entered into the system that relates to length, weight and volume.

28.1.2 Descriptions of Examples

28.1.2.1 Chocolate Bar

The first example that will be used throughout the implementation guide will be for a pallet of chocolate bars. The pallet consists of 64 cases of product and each case contains 30 bags (the sales unit) and each bag has 10 individually wrapped pieces of chocolate. For this example, the Functional

Unit is one piece of chocolate. Table 1 summarises all of the packaging components used for a single pallet.

Table 28-1 Packaging Description for Chocolate Bar Example

Component	Packaging Level	Material 1	(G)	Material 2	(G)	Material 3	(G)	Weight (g)	Qty	Total Weight (g)	Weight/FU
wrap	Primary	POLYMER_LLDPE	0.88	METAL_ALUMINUM	0.44	POLYMER_PP	0.88	2.2	19200	42240	2.2
bag	Primary	POLYMER_LLDPE	11.52	METAL_ALUMINUM	5.76	POLYMER_PP	11.52	28.8	1920	55296	184
Bag tie	Primary	POLYMER_LLDPE	5.04	METAL_STEEL	3.36			8.4	1920	16128	54
shipper label	Secondary	PAPER_PAPER	15					15	64	960	3.2
shipper	Secondary	PAPER_CORRUGATED	600					600	64	38400	128
Top sheet	Tertiary	PAPER_CORRUGATED	690					690	1	690	2.3
pallet label	Tertiary	PAPER_PAPER	15					15	1	15	0.1
pallet wrap	Tertiary	POLYMER_PP	245					245	1	245	0.8
Pallet	Tertiary	WOOD_OTHER	29,000					29,000	1	29000	97
Total packaging weight										182974	610

Primary Package = 1 FU
 Secondary Package = 300 FUs (10 Primary Packages/Bag)
 Tertiary Package = 19200 FUs (30 x 64 Secondary Packages/Pallet)

28.1.2.2 Laundry detergent

The second example that will be used throughout the implementation guide will be for a pallet of laundry detergent. The pallet consists of 50 cases of product and each case contains 4 bottles of detergent. For this example, the Functional Unit is the amount of product that is used to clean a single load of laundry. A single bottle is capable of cleaning 64 loads of laundry so the FU for a single bottle will be 64 summarises all of the packaging components used for a single pallet.

Based on the above, we can define the following:

functionalBasisUnitCode: NL
functionalBasisUnitDescription: The Amount of product required to clean 1 load.
quantityOfFunctionalBasisUnit: 1

Table 28-2 Packaging Description for Laundry Example

Component	Packaging Level	Material	Weight (g)	Qty	Total weight	Weight /FU
Bottle	Primary	POLYMER_HDPE	126	200	25,200	1.97
Label – Back	Primary	POLYMER_PP	1.1	200	220	.016
Label – Front	Primary	POLYMER_PP	1.1	200	220	.016
Transition Piece	Primary	POLYMER_PP	13.5	200	2700	.211
Cap	Primary	POLYMER_PP	13.2	200	2640	.206
Corrugate Case	Secondary	PAPER_CORRUGATE	650	50	32,500	2.54
Corrugate Tie Sheet	Tertiary	PAPER_CORRUGATE	400	2	800	.062
Corrugate Top Sheet	Tertiary	PAPER_CORRUGATE	690	1	690	.054
Stretch Wrap	Tertiary	POLYMER_LDPE	540	1	540	.042

Component	Packaging Level	Material	Weight (g)	Qty	Total weight	Weight /FU
Pallet	Tertiary	WOOD_OTHER	29,000	1	29,000	2.26

Primary Package = 64 FUs
 Secondary Package = 256 FUs (64 x 4 Primary Packages/Case)
 Tertiary Package = 12800 FUs (256 x 50 Secondary Packages/Pallet)

28.1.3 GPPS Attributes

The environmental relevance of the GPPS attributes will vary depending on at what level an indicator is reported. For example, reporting on recycled content is relevant at all packaging levels if it is reported by material category whereas it is less relevant if it is reported at a packaging item level when the item consists of several different materials. GS1 recommends that all indicators and attributes be reported at the level of highest environmental relevance. In cases when this cannot be achieved, the deviation should be clearly highlighted.

Each GPPS attribute has to be associated with a packaging component or constituent. The packaging component is described using the Packaging Level. For example, the bottle in the laundry example would be described using the following:

packagingLevelTypeCode: Primary
 packagingComponentDescription: Bottle
 packagingMaterialTypeCode: POLYMER_HDPE
 packagingMaterialDescription: Plastic Bottle (optional free text field)

28.1.3.1 Packaging Weight and Optimisation

28.1.3.1.1 Packaging Weight Optimisation

Relevant at all levels. This attribute has the highest relevance for the entire packaging system, e.g. pallet load, to ensure that all packaging levels have been optimised.

Packaging weight optimisation consists of two attributes, the actual weight (that needs to be entered as a value/FU) and Proof of Optimisation.

Laundry Detergent Example

For the laundry example, the weight was optimised using Both EN13428 and ISO18602. Here is how the data would be entered for each component:

ProofOfOptimisedPackagingWeightStandardCode: EN13428_ISO18602

Table 28-3 Critical Area

Component	<i>proofOfOptimisedPackagingWeightStandardDescription</i>
Bottle	Product protection
Label-Front	Consumer Acceptance
Label-Back	Consumer acceptance
Transition Piece	Consumer Acceptance
Cap	Product protection
Corrugate case	Product protection
Pallet	Logistics

Candy Bar Example

YES meets the ISO 18602 Optimisation Standard see the Critical area for each component:

ProofOfOptimisedPackagingWeightStandardCode: ISO18602

Table 28-4 Critical Area

Component	<i>proofOfOptimisedPackagingWeightStandardDescription</i>
wrap	Product protection
bag	Logistics
Bag tie	Consumer acceptance
shipper label	Logistics
shipper	Product protection
Top sheet	Product protection
pallet label	Logistics
pallet wrap	Product protection
Pallet	Product protection

28.1.3.1.2 Packaging Weight

For packaging weights refer to [Table 28-2](#).

28.1.3.1.3 Packaging Weight Reduction

This indicator has the highest environmental relevance at material constituent / material category level, e.g. PET or paper. A weight reduction can only be translated into environmental impacts if the type of material that is being reduced is known. This indicator therefore has lower relevance in all cases where a weight reduction is reported across material categories. To calculate a weight reduction a reference has to be made to the preceding packaging system. If the GTIN of the packaging format that is being replaced is available in GDSN reference should be made to this GTIN. Otherwise, the previous packaging format should be described in free text in a dedicated field.

The process has to be repeated for each individual component for which there is a change of weight. Within the current boundaries of the system, packaging weight reduction can only be entered at the component level. The weight reduction reporting procedure will be reviewed and may be subject to future changes.

Laundry Detergent Example

In this example, we will assume that this is a new compacted product that is compacted at a 2x level compared to the previous product. In order to simplify the calculations we will also assume that no packaging was change from the previous product, only that there are 2x more FU per bottle. In this case the following data would be entered for each component (only the bottle is show here for simplicity):

Bottle:

packagingComponentDescription:	Bottle
packagingWeightReduction:	1.97 g/FU
packagingWeightReductionProtocolName:	GPPS 2.0
proofOfPackagingWeightReductionStandardCode:	Field not recommended for use
proofOfPackagingWeightReductionDescription:	Replaces Non-Compacted Detergent
previousPackagingWeight: 128 FUs)	3.94 g/FU (Note: Same Bottle Weight

Weight reduction calculations have to be repeated for all packaging components for which there is a change of weight. The weight reduction calculation procedure may be reviewed and changed in a future update.

Candy Bar Example

This is a new product so no weight reduction is claimed.

28.1.3.2 Packaging to Product Weight Ratio

The recommended reporting level: pallet level to ensure that no weight is switched between packaging components.

Laundry Detergent Example

Total Packaging weight on Pallet = 94510 g

Total product weight on Pallet = 590000 g

Packaging to Product Ratio =

packagingToTradeItemWeightRatio: 0.16

Candy Bar Example

Packaging weight is 182974 g

Each chocolate weight is 25g x 19200 bars per case

Packaging to Product Ratio =

packagingToTradeItemWeightRatio: 0.38

28.1.3.3 Material Waste

This parameter is not intended to be cumulated across the life cycle but only as a measure of operational efficiency of the operator on the selling end of the transaction.

This metric is more suitable at the level of the packaging item in question during transactions in the upstream supply chain from the brand owner. Given the scope of current use of GDSN use of this particular metric is not recommended.

We do not have data to complete this attribute for either example.

28.1.3.4 Recycled Content

Relevant at all levels if reported by material category, i.e. "the cardboard on the pallet contains 50% recycled content". Less relevant if reported for a packaging item consisting of components made of different materials. It is highly recommended that Packaging Weight Optimisation is completed for any component with recycled content.

Laundry Detergent Example

In this example, the bottle is the only item that has recycled content (at a 25% level). The data that would be entered as follows (this data would be linked to the PackagingLevel data for the bottle):

packagingComponentDescription:	Bottle
packagingRecycledContentRatio:	25%
packagingRecycledContentTypeCode:	POST_CONSUMER_RECYCLED_CONTENT
packagingRecycledContentDescription:	NA

Candy Bar Example

Recycled content on a component and material basis, i.e. the aluminum layer of the wrap and bag has 10% post-consumer recycled content (PCR)

packagingComponentDescription:	Wrap
packagingConstituent:	Aluminium layer
packagingMaterialTypeCode:	METAL_ALUMINUM
packagingRecycledContentRatio:	10%

packagingRecycledContentTypeCode: POST_CONSUMER_RECYCLED_CONTENT
 packagingRecycledContentDescription: NA

packagingComponentDescription: Bag
 packagingConstituent: Aluminium layer
 packagingMaterialTypeCode: METAL_ALUMINUM
 packagingRecycledContentRatio: 10%
 packagingRecycledContentTypeCode: POST_CONSUMER_RECYCLED_CONTENT
 packagingRecycledContentDescription: NA

Shipper PAPER_CORRUGATED:

packagingComponentDescription: Shipper
 packagingConstituent: Shipper
 packagingMaterialTypeCode: PAPER_CORRUGATED
 packagingRecycledContentRatio: 50%
 packagingRecycledContentTypeCode: POST_CONSUMER_RECYCLED_CONTENT
 packagingRecycledContentDescription: 0.25 Post consumer

Top sheet PAPER_CORRUGATED:

packagingComponentDescription: Top Sheet
 packagingConstituent: Top sheet
 packagingMaterialTypeCode: PAPER_CORRUGATED
 packagingRecycledContentRatio: 50%
 packagingRecycledContentTypeCode: POST_CONSUMER_RECYCLED_CONTENT
 packagingRecycledContentDescription: 0.25 Post consumer

Shipper Label:

packagingComponentDescription: Shipper label
 packagingConstituent: Shipper label
 packagingMaterialTypeCode: PAPER_PAPER
 packagingRecycledContentRatio: 25%
 packagingRecycledContentTypeCode: POST_CONSUMER_RECYCLED_CONTENT
 packagingRecycledContentDescription: NA

Pallet Label:

packagingComponentDescription: Pallet label
 packagingConstituent: Pallet label
 packagingMaterialTypeCode: PAPER_PAPER
 packagingRecycledContentRatio: 25%
 packagingRecycledContentTypeCode: POST_CONSUMER_RECYCLED_CONTENT
 packagingRecycledContentDescription: NA

28.1.3.5 Renewable Content

Most relevant if reported by material category irrespective of the level at which the metric is reported, i.e. “the PE on the pallet has 100% renewable content”, rather than calculating the renewable content based on the total material weight on the pallet.

Laundry Detergent Example

In this example, the paper components are 100% renewable. Procedure has to be repeated for all components with renewable content.

Corrugate Case:

packagingRenewableContentRatio: 100%
 packagingRenewableContentTypeCode: ISO_14021
 packagingRenewableContentDescription: NA (this field is reserved as a description in cases where the packagingRenewableContentTypeCode is selected as “OTHER”)

Pallet:

packagingRenewableContentRatio: 100%
 packagingRenewableContentTypeCode: ISO_14021
 packagingRenewableContentDescription: NA (this field is reserved as a description in cases where the packagingRenewableContentTypeCode is selected as “OTHER”)

Candy Bar Example

All the paper components are 100% renewable material. In this example, none of the polymer are bio-based.

Shipper

packagingComponentDescription: Shipper
 packagingMaterialTypeCode: PAPER_CORRUGATED
 packagingRenewableContentRatio: 100%
 packagingRenewableContentTypeCode: ISO_14021
 packagingRenewableContentDescription: NA

Top Sheet

packagingComponentDescription: Top Sheet
 packagingConstituent: Top sheet
 packagingMaterialTypeCode: PAPER_CORRUGATED
 packagingRenewableContentRatio: 100%
 packagingRenewableContentTypeCode: ISO_14021
 packagingRenewableContentDescription: NA

Shipper label

packagingComponentDescription: Shipper label
 packagingConstituent: Shipper label
 packagingMaterialTypeCode: PAPER_PAPER
 packagingRenewableContentRatio: 100%
 packagingRenewableContentTypeCode: ISO_14021
 packagingRenewableContentDescription: NA

Pallet label

packagingComponentDescription: Pallet label
 packagingConstituent: Pallet label
 packagingMaterialTypeCode: PAPER_PAPER
 packagingRenewableContentRatio: 100%
 packagingRenewableContentTypeCode: ISO_14021
 packagingRenewableContentDescription: NA

Pallet:

packagingRenewableContentRatio: 100%
 packagingRenewableContentTypeCode: ISO_14021
 packagingRenewableContentDescription: NA (this field is reserved as a description in cases where the packagingRenewableContentTypeCode is selected as "OTHER")

28.1.3.6 Packaging Chain of Custody

Only relevant by material category - i.e. source certification of cardboard on pallet

Laundry Detergent Example

No packaging chain of custody exists for any of the components.

Candy Bar Example

Both the shipper and the top sheet are 100% FSC certified.

Table 28-5 Candy Bar Example - Packaging Chain of Custody

Component	Material 1	%	sourceCertificationSystemProtocolCode
Shipper	PAPER_PAPER	100	FOREST_STEWARDSHIP_COUNCIL
Top sheet	PAPER_CORRUGATED	100	FOREST_STEWARDSHIP_COUNCIL

Shipper:

packagingComponentDescription: Shipper
 packagingMaterialTypeCode: PAPER_PAPER
 packagingChainOfCustodySourceCertifiedCode: SOURCE_CERTIFIED
 packagingChainOfCustodyEventSequenceNumber: 1
 sourceCertificationSystemProtocolCode: FOREST_STEWARDSHIP_COUNCIL
 sourceCertificationSystemProtocolDescription: NA (Descriptor for use only if sourceCertificationSystemProtocolCode is selected as "OTHER")

Top Sheet:

packagingComponentDescription: Top Sheet
 packagingConstituent: Top sheet
 packagingMaterialTypeCode: PAPER_CORRUGATED
 packagingChainOfCustodySourceCertifiedCode: SOURCE_CERTIFIED
 packagingChainOfCustodyEventSequenceNumber: 2
 sourceCertificationSystemProtocolCode: FOREST_STEWARDSHIP_COUNCIL
 sourceCertificationSystemProtocolDescription: NA (Descriptor for use only if sourceCertificationSystemProtocolCode is selected as "OTHER")

28.1.3.7 Assessment and Minimisation of Substances Hazardous to the Environment

The highest relevance at pallet level - ensures that all packaging components and levels have been addressed. The process has to be repeated for each component in the packaging system.

Candy Bar Example & Laundry Detergent Example

All components meet ISO 18602:2013 Packaging and the environment - Optimisation of the packaging system (includes minimisation of heavy metals and hazardous substances)

hazardousSubstancesMinimizationCode: EN_13428
 haveYouMinimisedHazardousSubstance: YES
 relevantSupportingSubstanceHazardousDocumentation: YES

28.1.3.8 Production Sites Located in Areas with Conditions of Water Stress or Scarcity

The highest relevance at pallet level - use at other levels should be limited to transactions involving only parts of the full packaging system and the metric should then cover all production sites involved in the production of the constituents going into the item which is to be transferred from one value chain partner to another.

Candy Bar Example & Laundry Detergent Example

Data not available

28.1.3.9 Packaging Reuse Rate

This is only relevant for the packaging item which is being re-used. For example, the pallet is reused 20 times before recovery through incineration.

Candy Bar Example & Laundry Detergent Example

Only the pallet is reusable has an average of 19 turns

packagingReusabilityStandardCode: EN 13429

packagingReusabilityStandardDescription N/A (Field only used when "OTHER" is selected in the previous field)

numberOfCyclesPriorToWithdrawal 19

- **Note:** Field to be used only when reporting Reuse Rate as "number of cycles prior to withdrawal". For all other cases, use "packaging reuse rate" to report loss rates or top-up rates as a percentage.

28.1.3.10 Packaging Recovery Rate

This should be reported by material category together with the distribution between different recovery alternatives for highest environmental relevance. Note that recovery rates are specific to the region of sales and should not be entered unless you have a confirmation between trading partner on where the product is to be sold as well as what information source should be used as a reference for recovery rates.

28.1.3.11 Cube Utilisation

Highest relevance at pallet level, but may also have relevance at a sales-packaging level in terms of shelf-space occupation for the retailer.

Candy Bar Example:

packagingCubeUtilisationRatio 17.63%

Pallet level Example of how calculation was completed
 Volume of each FU (one piece of chocolate) is L = 3 cm W = 3 cm H = 0.5 cm 4.5 cm³
 There are 19200 piece in a pallet 19200 *4.5 = 86,400 cm³
 The pallet is 70 cm by 70 cm by 100 cm = 490,000 cm³
 The cube utilisation is 86,400/490,000 = 17.63%

28.1.3.12 Total Cost of Packaging

Relevant at all levels, depending on where in the packaging value chain the transaction takes place. In the case of a brand owner to a retailer the highest relevance is for the entire pallet.

Candy Bar and Laundry Example:

This company does not want to disclose this information

28.1.3.13 Packaged Product Wastage

Only relevant at pallet level

Candy Bar and Laundry Example:

Data not available

28.1.3.14 Packaged product shelf life

The metric refers is only relevant for the primary packaging.

Candy Bar and Laundry Example:

Data not available

28.1.3.15 Community investment

Not related to packaging levels -can be communicated at any level

28.1.4 Life Cycle Assessment Indicators

28.1.4.1 Reporting level

Life Cycle Indicators shall be reported at the highest (e.g. pallet) level but no higher than pallet level.

Candy Bar Example:

Pallet

Functional unit

One piece of chocolate, There are 19200 FU on one pallet

28.1.4.2 LCA Tools & Methodologies

A wide variety of streamlined tools dedicated to environmental assessment of packaging are available on the market. Their compliance with the recommended methodologies in GPPS 2.0 should be evaluated before they are used to generate data for input into GDSN. Two of these tools have already performed an auto-evaluation with respect to their compliance with the methodological recommendations for LCA of packaging in GPPS 2.0 (see table below). Some of the methodologies concerning impact category indicators are still under debate and GPPS 2.0 therefore recommends several methodologies for certain LCA impact category indicators. The most important point is that information entered into GDSN should be transparent in terms of the methodology and data used to generate the metric in question.

Figure 28-3 LCA Tool 1

		LCA Tool				COMPASS			
		PIQET		Reference unit	Compliant (yes/no)			Reference unit	Compliant (yes/no)
GPP recommended protocol	Reference substance	Methodology	Protocol name			Methodology	Protocol name		
VDI-4600 Cumulative Energy Demand: Terms, Definitions, Methods of Calculation, 1997.	MJ / FU	CML 2000		MJ LHV / FU	Yes	Fossil Fuel Consumption		MJ eq / FU	N
GPPS 2.0	m ³ /FU L / FU	Inventory (non-turbined)		kL/FU = M3/FU	Yes	Inventory (surface and groundwater)		L/FU	Y
ReCiPe (land occupation) IMPACT 2002+ Ecoindicator-99	m ² × years / FU m ² Organic arable land eq × year/FU m ² Organic arable land eq × year/FU	CML 2000		Ha × yr / FU	No	-			
IPCC 4th assessment report IPCC 3rd assessment report	kg CO ₂ eq/FU kg CO ₂ eq/FU		IPCC 4th assessment report	kg CO ₂ eq/FU (100)	Yes	IPCC	IPCC 4th assessment report	kg CO ₂ eq / FU(100)	Y
WMO 1990	kg CFC-11 eq. / FU	-	-	-	-	-	-	-	-
Impact 2002 LIME2 USEtox	kg C2H3Cl eq / FU kg C6H6 air eq / FU CTU / FU	-	-	-	-	USEtox	USEtox	DALY / FU	N
Impact 2002 LIME2 USEtox	kg C2H3Cl eq / FU kg C6H6 air eq / FU CTU / FU	-	-	-	-	USEtox	USEtox	DALY / FU	N
ReCiPe	kg PM10 eq / FU kg PM2.5 eq / FU	-	-	-	-	USEtox	USEtox	DALY / FU	N
Frischknecht (2000) ReCiPe	kg U235 eq / FU kg NMVOC eq / FU	-	-	-	-	-	-	-	-
ReCiPe LIME2 TRACI	kg SO ₂ eq / FU kg SO ₂ eq / FU H+ eq/yr/ FU	-	-	-	-	-	-	-	-
ReCiPe EDIP2003 LIME2 TRACI	kg P eq / FU kg N eq / FU			kg PO4(3-) eq / FU	No	CML 2000	CML 2000	kg PO4(3-) eq / FU	Y
USEtox CML 2002 ReCiPe TRACI	CTU / FU kg 1,4 DB equivalent/FU kg 1,4 DB equivalent/FU kg 2,4 D equivalents/FU	CML 2000				USEtox	USEtox	CTUe / FU	Y
CML 2002 EDIP 1997	kg antimony equivalents / FU Person reserve (kg) / FU	Eco-indicator		MJ Surplus	No	-	-	-	-

Candy Bar Example: Life cycle assessment indicators

PackagingLevel: Pallet
 globalWarmingPotentialEquivalentBasisYearsCode: 100
 globalWarmingPotentialEquivalentBasisYearsDescription: [Use only when "OTHER" is selected]
 globalWarmingPotentialEquivalentSubstanceCode: KG_CO2_EQ_PER_FU
 globalWarmingPotentialEquivalentSubstanceDescription: [Use only when "OTHER" is selected]
 globalWarmingPotentialEquivalent: 2.39E-05
 globalWarmingPotentialEquivalentProtocolCode: IPCC_4TH_ASSESSMENT_REPORT
 globalWarmingPotentialEquivalentProtocolDescription: [Use only when "OTHER" is selected]

PackagingLevel: Pallet
 CumulativeEnergyDemand: 9.207e +0
 CumulativeEnergyDemandTypeCode: CUMULATIVE_ENERGY_DEMAND_NON_RENEWABLE
 CumulativeEnergyDemandReferenceSubstanceCode: MJ_PER_FU
 cumulativeEnergyDemandProtocolCode: VDI_4600_CED

PackagingLevel: Pallet
 aquaticEutrophicationModelCode: EDIP2003
 aquaticEutrophicationModelDescription: [Use only when "OTHER" is selected]
 aquaticEutrophicationReferenceSubstanceCode: KG_P_EQ_PER_FU
 aquaticEutrophicationReferenceSubstanceDescription: [Use only when "OTHER" is selected]
 aquaticEutrophicationMeasurement: 1.815e-4

aquaticEutrophicationWaterBodyTypeCode:	RECEIVING_MEDIA_FRESHWATER
aquaticEutrophicationWaterBodyDescription:	
PackagingLevel:	Pallet
massEquivalentMeasurement:	2.92E-08
massEquivalentCode:	PHOTOCHEMICAL_OZONE_CREATION_POTENTIAL_POCP
massEquivalentProtocolCode:	RECIPE
massEquivalentProtocolDescription:	[Use only when "OTHER" is selected]
massEquivalentSubstanceCodeReference:	KG_NMVOC_EQ_PER_FU
massEquivalentSubstanceDescription:	
PackagingLevel:	Pallet
massEquivalentMeasurement:	2.53E-10
massEquivalentCode:	M2_YEAR_ORGANIC_ARABLE_LAND-EQ_PER_FU
massEquivalentProtocolCode:	RECIPE
massEquivalentProtocolDescription:	[Use only when "OTHER" is selected]
massEquivalentSubstanceCodeReference:	KG_NMVOC_EQ_PER_FU
<i>massEquivalentSubstanceDescription:</i>	<i>[Use only when "OTHER" is selected]</i>

29 Population of Brand/Sub Brand Information

This section describes how to brand owners can populate brand information via the GDSN.

29.1 Pre-Requisite

The following are pre-requisites for using this guidance

- Brand owner or other sellers of the trade item are using GDSN to provide product information to downstream trading partners
- The following attributes, as referenced in this document, are used to provide brand name information as noted:
 - Minimum attributes for use:
 - brandName - This is the key attribute for population of the brand name of the trade item
 - Other attributes which, when used, provide additional clarity:
 - subBrand - This attribute can provide additional clarification for the brand name
 - languageSpecificBrandName - This attribute can be used when a brand name has a language variant for it. For example if the brand name in English is Little Flower, but in French it is stated as Petit Fleur
 - languageSpecificSubBrandName - This attribute can be used to provide additional clarification for a brand name which has a language variant for it. For example if the brand name in English is Little Flower, but in French it is stated as Petit Fleur
- Other attributes which are referenced in this document are:
 - functionalName - a short generic name assigned by the data source for grouping of their products. This naming structure can be different from one data source to the next
 - invoiceName - a short name for the item which can be printed on an invoice

- descriptionShort - a short name for the item which can be used in recipient systems and on shelf tags, typically carries abbreviations
- tradeItemDescription - a medium name for the item with only a few abbreviations
- AdditionalTradeItemDescription\text - a long name for the item with no abbreviations

29.2 When Would I Use This?

Companies who should review this guidance and determine how to implement its intent are (but not limited to):

- Brand Owners who are using GDSN to provide product data to their customers
 - Distributors, GPO, Brokers, Agents who represent Trade Items for Brand Owners who are not utilising GDSN to provide product data, but need to provide product data to their customers
- **Note:** This document contain guidance on how brand information might be populated. The actual decision on what to share, how it is shared, and the values populated in the specific fields rests solely on the Brand Owner or its assigns. The recipients of the information may make suggestions, but must understand brand information decisions rest with the Brand Owners.

29.3 How to populate Brand Information

Brand information is useful in identifying the Trade item and differentiating it from other similar Trade Items. Brand information helps the consumer of a Trade Item relate to the item and find it in the marketplace.

The key piece of Brand Information is the Brand Name. This is the most common name used to describe the Brand to consumers of the Trade Item on its packaging.

29.3.1 What is the difference between a Brand Name and a Trade Item Name

When defining a Trade Item, there are several name/description attributes which can be used to provide more information to users of the product understand what it is. There is a difference between the item's brand name and the name or description of the item.

- Brand name:
 - Assigned by Brand Owner
 - Most recognisable "Brand" to the Consumer
 - Consumer can have a connection/recognition with the brand in their buying experience for that product (How the consumer recognises the product)
 - Should be printed on the packaging of the item as a customer facing selling or identification element for the product. Exception is when the product has no packaging
 - Can be, but is not required to be, the company name or division name of the Brand Owner
- Product name/description:
 - Product name may be similar to other products under a different brand
 - Can be the same as the brand name
 - Typically more descriptive of the item

29.3.2 What significance does the Brand Name have to the ultimate user of the product?

The brand name of a trade item is an important piece of information as it assists users to differentiate similar items from each other. While the user can differentiate an item from other similar items, the brand can also group similar items or related items together to form a family of

items. For example Brand A is assigned to a set of mechanical pencils and pens. Under Brand A, there are 17 different types or designs of these items.

The Data Recipients have the ultimate use of the brand name to represent the item to the Consumer. While the Brand Owner is responsible for determining or defining the brand name for the item, the recipients will use the brand name in marketing to consumers of the item. Web and Mobile Commerce applications use Brand Name as a search feature allowing for better/more complete results to be presented to a user.

29.3.3 Why is “Brand Name” needed and what is it used for?

The brand name is used for a number of different purposes. The purposes vary based in the point in the supply chain the information is used.

- In Store Communications
 - Shelf Tag
 - POS/Sales Slip
- Promotions
 - In-store Promotion
 - Compare similar products in a brand and from one brand to another
- Online Commerce
 - Search functionality
 - Catalogue Listings
 - Product Grouping

29.3.4 Other important guidance

There are several points which need to be called out specifically

- The Brand name may not be the largest brand text or trade item name/description on the package. Marketing or package designers determine how names and descriptions are listed on the package. It may be determined that the size of a brand name should be small to fit into the artistic or aesthetic design for the package.
- Over time sub brand may be promoted to be a brand. Decision of this change and its timing is up to the Brand Owner. The Brand Owner will need to follow all GTIN Management Standard which relate to addition/change/removal of brand names from a trade item.
- A branded ingredient may be listed on the packaging and/or part of the trade item description, but may not necessarily be a brand/subbrand of the item. If an item utilises an ingredient which has a recognisable brand on its own, the Brand Owner may choose to call out the ingredient on the packaging as a sales tool but does not need to identify that ingredient brand as the brand of the Trade Item
- The use of an “Endorsing Brand” for an item and is not necessarily a brand for the item. An “Endorsing Brand” is a mark or name on a package which is a brand which is an overarching brand or owning brand of the product. Having these marks or names on the package may help to provide recognition to a Trade Item’s Brand Name. Typically an Endorsing Brand is not the item’s primary brand.

29.4 Examples of Population

The following are examples of how a Brand Owner might determine the values to provide branding information for a product. These examples are to be used as input for a decision. It is the Brand Owner’s decision as to the specific information to provide.

29.4.1 Example 1

Great Grains has decided to introduce a new cereal. It has set up a license agreement with a local confection manufacturer, **Favourite** to utilise the name of a popular confection as the name of the cereal **Puffed Chocolate**. This confection is globally known and recognised. It should also be noted that one of the main ingredients in the product is cocoa which is supplied from **Favourite**. Part of the license and use of the cocoa has a call out placed on the package signifying that the cocoa is in the package (branded ingredient).



The Brand Owner has determined the following for this item:

- brandName can be **Great Grains**
- subBrand can be **Puffed Chocolate**
- descriptionShort should contain, at a minimum, **Puffed Chocolate**
- **Great Grains, Puffed Chocolate** and the **Favourite Cocoa** statement could be part of the tradeItemDescription and additionalTradeItemDescription (if the additional description is utilised)

29.4.2 Example 2

Blend manufactures dairy products. This product is a 6-pack of small apple flavoured yogurt cups. To highlight this line of products, which consists of different flavours in this unique package, **Blend** has sub branded the product line as **Yogurt Snackers**. As a branded ingredient, the item contains **Forest Glen Crunchy Multigrain Chips**, a very popular snack item on its own.



The Brand Owner has determined the following for this item:

- brandName can be **Blend**
- subBrand can be **Yogurt Snacker**
- descriptionShort should contain, at a minimum, **Yoghurt Snacker** and **flavour**
- **Blend**, **Yogurt Snacker**, flavour, and the **Forrest Glen** statement could be part of the tradeItemDescription and additionalTradeItemDescription (if the additional description is utilised)

29.4.3 Example 3

Antonio's manufactures a fried chicken product under the product line **EXTREME**. The product utilises a branded ingredient, **Jumping Joe's Buffalo Sauce**.



The Brand Owner has determined the following for this item:

- brandName can be **Antonio's**
- subBrand can be **EXTREME**
- descriptionShort should contain, at a minimum, **EXTREME**
- **Antonio's**, **EXTREME**, and **Jumping Joe's** statement could be part of the tradeItemDescription and additionalTradeItemDescription (if the additional description is utilised)
- **Note:** If the verbiage indicates a brand grouping of similar items or a marketing descriptor, it is best to list the verbiage as the subBrand.
- **Note:** If the item is a one off product or marketing descriptor, the Brand Owner may choose to not list the verbiage as the subBrand.

29.4.4 Example 4

Chef Sara manufactures several lines of baking mixes. One of the lines is **Organic Wheat**. These products are various mixes under the **Organic Wheat** banner.



The Brand Owner has determined the following for this item:

- brandName can be **Chef Sara**
- subBrand can be **Organic Wheat**
- descriptionShort should contain, at a minimum, **Organic Wheat**
- **Organic Wheat**, could be part of the tradeItemDescription and additionalTradeItemDescription (if the additional description is utilised)

29.4.5 Example 5

Chef Sara manufactures several lines of baking mixes. One of the lines is **Super Delight**. These products are various mixes under the **Super Delight** banner.



The Brand Owner has determined the following for this item:

- brandName can be **Chef Sara**
- subBrand can be **Super Delight**
- descriptionShort should contain, at a minimum, **Super Delight** and **flavour**
- **Chef Sara**, **Super Delight** and **flavour** could be part of the tradeItemDescription and additionalTradeItemDescription (if the additional description is utilised)

29.4.6 Example 6

Chef Sara manufactures several lines of baking mixes. One of the lines is **Fluffy**. These products are various mixes under the **Fluffy** banner. As a branded ingredient, the item contains **Favourite Cocoa**, a very popular snack item on its own.

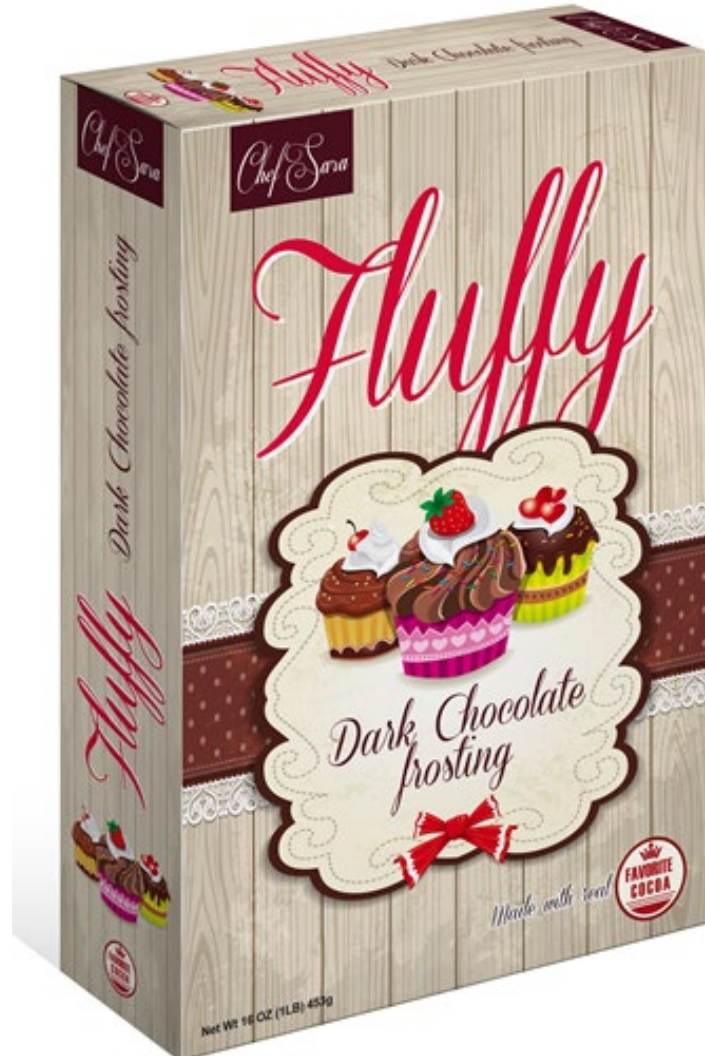

The Brand Owner has determined the following for this item:

- brandName can be **Chef Sara**
- subBrand can be **Fluffy**
- descriptionShort should contain, at a minimum, **Fluffy** and **flavour**
- **Chef Sara, Fluffy**, and **flavour**, could be part of the tradeItemDescription and additionalTradeItemDescription (if the additional description is utilised)

29.4.7 Example 7

Chef Sara manufactures several lines of baking mixes. One of the lines is **Fluffy**. These products are various mixes under the **Fluffy** banner.



The Brand Owner has determined the following for this item:

- brandName can be Chef Sara
- subBrand can be Fluffy
- descriptionShort should contain, at a minimum, Fluffy and flavour
- Chef Sara, Fluffy, and flavour could be part of the tradeItemDescription and additionalTradeItemDescription (if the additional description is utilised)

29.4.8 Example 8

Foodservice is a distributor of food products in the foodservice industry (restaurant/commercial kitchen supply). As one of their offerings, they have contracted for some items to be manufactured as a private label product under their brand of **Foodservice**. Under this brand one of the product lines is called "**Classic**".



The Brand Owner has determined the following for this item:

- brandName can be Foodservice
- subBrand can be Classic
- descriptionShort should contain, at a minimum, Classic and All-Purpose H and R Flour
- Foodservice, Classic, and All-Purpose H and R Flour could be part of the tradeItemDescription and additionalTradeItemDescription (if the additional description is utilised)

29.4.9 Example 9

Great Grains, through the course of business, came to acquire the **Royal Seal** brand. In the marketplace, **Royal Seal** is such a known brand that many consumers call the product by the brand name. For the consumer, they do not really associate the product to the **Great Grains** name.



The Brand Owner has determined the following for this item:

- brandName can be Royal Seal
- subBrand can be Sumptuous,
- descriptionShort should contain, at a minimum, Sumptuous, and flavour (Devil's Food)
- Great Grains, Royal Seal, Sumptuous, and flavour (Devil's Food) could be part of the tradeItemDescription and additionalTradeItemDescription (if the additional description is utilised)

29.4.10 Example 10

A manufacturer of laundry products has manufactured a new cleaning product which combines products from 2 different product lines, “**CLEAN**” and “**CONTENT**”. The new product will be marketed under the **Clean** product line. The **Content** portion of the item is considered a branded ingredient.



The Brand Owner has determined the following for this item:

- brandName can be Clean
- No subBrand
- descriptionShort should contain, at a minimum, Clean and Content
- Clean and Content could be part of the tradeItemDescription and additionalTradeItemDescription (if the additional description is utilised)

29.4.11 Example 11

A food manufacturer manufactures a dessert confection under a brand mark. The brand mark utilises no words on the package, but has a name in the local markets into which it is sold. The brand is called **Star Brand**, in English.



The Brand Owner has determined the following for this item:

- brandName can be Starbrand
- No subBrand
- languageSpecificBrandName can be specified for each target market
 - **STERNE-MARKE** for Germany in German
 - **STER-MERK** for Netherlands in Dutch
- descriptionShort should contain, at a minimum, Confetti
- languageSpecificBrandName and Confetti could be part of the tradeItemDescription and additionalTradeItemDescription (if the additional description is utilised)
- languageSpecificBrandName (specified by Target Market) and Confetti would be part of the additionalTradeItemDescription (if the additional description is utilised)

29.4.12 Example 12

A food manufacturer manufactures a dessert confection under a brand mark. The brand mark utilises no words on the package, but has a name in the local markets into which it is sold. The brand is called **Star Brand**, in English.



The Brand Owner has determined the following for this item:

- brandName can be **Starbrand**
- No subBrand
- languageSpecificBrandName can be specified for each target market
 - **STERNE-MARKE** for Germany in German
 - **STER-MERK** for Netherlands in Dutch
- descriptionShort should contain, at a minimum, Diat Eisgenuss
- languageSpecificBrandName and Diat Eisgenuss could be part of the tradeItemDescription and additionalTradeItemDescription (if the additional description is utilised)
- languageSpecificBrandName (specified by Target Market) and Diat Eisgenuss would be part of the additionalTradeItemDescription (if the additional description is utilised)

29.4.13 Example 13

Royal brand is a manufacturer of Tea. Their products are sold in multiple markets. Some of these products have one of the package surfaces are in a local language, while the other surfaces are in English.



The Brand Owner has determined the following for this item:

- brandName can be Royal
- subBrand can be House Brand Tea
- Manufacturer determination as to which is the appropriate language characters to utilise for both. The brand may not be written on the packaging/label in the language character set in these attributes.
- languageSpecificBrandName should be specified for other languages in the appropriate character sets as needed
- descriptionShort should contain, at a minimum, House Brand Tea
- House Brand Tea could be part of the tradeItemDescription and additionalTradeItemDescription (if the additional description is utilised)

29.4.14 Example 14

Royal brand is a manufacturer of Tea. Their products are sold in multiple markets. Some of these products utilise local languages on all package surfaces. This example is of a product in a Cyrillic language.



The Brand Owner has determined the following for this item:

- brandName can be Royal - Manufacturer determination as to which is the appropriate language characters to utilise for both. The brand may not be written on the packaging/label in the language character set in these attributes
- languageSpecificBrandName should be specified for other languages in the appropriate character sets as needed
- descriptionShort should contain, at a minimum, Royal
- Royal could be part of the tradeItemDescription and additionalTradeItemDescription (if the additional description is utilised)

29.4.15 Example 15

Royal brands manufactures a cream cheese product under a very popular product name of **Amsterdam**.



The Brand Owner has determined the following for this item:

- endorser is Royal
- brandName can be Amsterdam
- Determination of the brand is up to the Brand Owner. Options are; Amsterdam, Royal Amsterdam, and Royal
- If Royal is chosen as the brand, subBrand can be Amsterdam
- descriptionShort should contain, at a minimum, Amsterdam
- Royal, and Amsterdam could be part of the tradeItemDescription and additionalTradeItemDescription (if the additional description is utilised)
- The cream cheese statement might need to be placed in the description fields to help provide clarity between this product and others.

29.4.16 Example 16

Dairy Fresh manufactures dairy product through a federation of dairies across a target market. While the federation is new in some local areas, the local dairy (for example **Green Pastures** or **Farmer's Dairy**) may be very well known to the consumer. **Dairy Fresh** continues to list the local dairy on the product label.



The Brand Owner has determined the following for this item:

- brandName can be MoMilk
- With multiple Dairies there is NO subBrand
- descriptionShort should contain, at a minimum, MoMilk
- MoMilk could be part of the tradeItemDescription and additionalTradeItemDescription (if the additional description is utilised)

29.4.17 Example 17

Farmer's Fresh Dairy manufactures an ice cream product. **Paw Prints** is a popular confection which is utilised as a branded ingredient.



The Brand Owner has determined the following for this item:

- brandName can be Farmer's
- subBrand can be Fresh Dairy
- descriptionShort should contain, at a minimum, Chocolate Paw Prints
- Chocolate Paw Prints could be part of the tradeItemDescription and additionalTradeItemDescription (if the additional description is utilised)

29.4.18 Example 18

ProLabs acquired a product line, **Nucare**, which was acquired to complement an existing product line they currently manufacture, **PreNourish**. **ProLabs** decided to have both brands be placed on the package.



The Brand Owner has determined the following for this item:

- brandName can be PreNourish
- subBrand can be NuCare
- descriptionShort should contain, at a minimum, NuCare
- PreNourish and NuCare could be part of the tradeItemDescription and additionalTradeItemDescription (if the additional description is utilised)

29.4.19 Example 19

AAAA manufactures a paper clip.



The Brand Owner has determined the following for this item:

- brandName can be AAAA
- There is NO subBrand
- descriptionShort should contain, at a minimum, AAAA
- AAAA could be part of the tradeItemDescription and additionalTradeItemDescription (if the additional description is utilised)

29.4.20 Example 20

Choiceware is a software company which manufactures a suite of software for use in an office under the title of **Work**. One of the products in this suite of products is a cloud based service called **Work 365**.



The Brand Owner has determined the following for this item:

- brandName can be Choiceware
- subBrand can be Work or Work 365 (or there may be none depending on how the manufacturer views the product)
- descriptionShort should contain, at a minimum, Work 365
- Choiceware Work 365 Personal Platinum could be part of the tradeItemDescription and additionalTradeItemDescription (if the additional description is utilised)
- Variant could be used to communicate product differentiator such as Home Premium, University, Small Business, etc.

29.4.21 Example 21

Allergenox manufactures a line of water filtration products under the product line of **Clean Filter**.



The Brand Owner has determined the following for this item:

- brandName can be Allergenox
- subBrand can be Clean Filter (or there may be none depending on how the manufacturer views the product)
- descriptionShort should contain, at a minimum, Clean Filter
- Allergenox Clean Filter could be part of the tradeItemDescription and additionalTradeItemDescription (if the additional description is utilised)

29.4.22 Example 22

Menucraft manufactures products for cooking and preparing food. This product is a set of cookware in the product line titled **Cook's Choice**.



The Brand Owner has determined the following for this item:

- brandName can be Menucraft
- subBrand can be Cook's Choice
- descriptionShort should contain, at a minimum, Menucraft Cook's Choice
- Menucraft Cook's Choice could be part of the tradeItemDescription and additionalTradeItemDescription (if the additional description is utilised)

29.4.23 Example 23

Great Games is a software manufacturer for video games. One of their products is a series of games for the family under the title of **Family Game Night** and designed to be utilised with the **Vii** gaming console.



The Brand Owner has determined the following for this item:

- brandName can be Great Games
- There is NO subBrand
- descriptionShort should contain, at a minimum, Great Games and Vii
- Great Games and Vii could be part of the tradeItemDescription and additionalTradeItemDescription (if the additional description is utilised)

29.4.24 Example 24

Builder's is a manufacturer of power and hand tools. One of their product lines is **Woodworker**.



The Brand Owner has determined the following for this item:

- brandName can be Builder's
- subBrand can be Woodworker
- descriptionShort should contain, at a minimum, Builder's and Woodworker
- Builder's and Woodworker could be part of the tradeItemDescription and additionalTradeItemDescription (if the additional description is utilised)

29.4.25 Example 25

John Smith's is a clothing manufacturer. In the marketplace they are known by several different monickers and logos (**John's Jeans**, **John Smith's**, and the cow's head logo). There are products which utilise some or all of these on the item in various places. This example as a permanent label, in leather, sewn into the wasitband of the product. It also carries 2 other removable labels, one with the barcode, and meausrements. The other is a marketing tg to highlight features of the product.



The Brand Owner has determined the following for this item:

- brandName can be John's or John Smith's
- subBrand can be A10
- descriptionShort should contain, at a minimum, John's or John Smith's and A10
- John's or John Smith's and A10 could be part of the tradeItemDescription and additionalTradeItemDescription (if the additional description is utilised)

29.4.26 Example 26

Favourite is a manufacturer of popular confections. In its product portfolio, there are a number of product lines with which the consumers are directly aligned, **Click Clack**, **Coconut Passion**, **Licorice**, **Meese's**, and **Rock Candy**. This product is a bag of small bite size pieces of each of these products. It does not have a prevailing brand on the package, but does have all of the branded ingredients listed on package.



The Brand Owner has determined the following for this item:

- brandName can be Favourite or Favourite/Meese's (Favourite views Meese's as the largest brand in the package)
- There is NO subBrand
- descriptionShort should contain, at a minimum, Favourite/Meese's
- Favourite or Favourite/Meese's could be part of the tradeItemDescription and additionalTradeItemDescription (if the additional description is utilised)

29.4.27 Example 27

Foodservice is a distributor of products for the foodservice industry (restaurant/commercial kitchen supply). As one of their offerings, they have contracted for some items to be manufactured as a private label product under their brand of **Foodservice**. Under this brand one of the product lines is called **Cap Block**. The contract manufacturer is **Organic Lab**. Foodservice has decided to allow **Organic Lab** to be listed on the product as an endorsing partner.



The Brand Owner has determined the following for this item:

- brandName can be Foodservice
- subBrand can be either Capblock or Pot and Pan
- descriptionShort should contain, at a minimum, Capblock and Pot & Pan
- Foodservice, Capblock and Pot & Pan could be part of the tradeItemDescription and additionalTradeItemDescription (if the additional description is utilised)

30 Chemical Ingredients

30.1 Purpose of this Topic

This section can be used to implement the information related to Chemical Ingredients Information, Chemical Regulation Information, Data Certification process, Transportation Classification Information, Safety Data Sheet Information, Safety Data Sheet File Information, Dangerous Goods, etc.

30.2 Who Will Use this Document?

This document is intended for participating members of GDS and potentially third parties that may additionally supplement information into the network.

Part of this process enables the capability of Certified Data to be passed through the network.

- What is a Certifying Body? It is a neutral company founded in auditing companies based upon process, security and any other items that need to be documented properly. Initially NSF International was chosen as the Chemical Ingredient Certifying Body.
- What is a 3rd Party Chemical Assessment Company? It is a company who specialises in assessing chemical ingredients and the associated information about the chemicals of a trade item. For example many of these companies author Safety Data Sheets also known as Material Safety Data Sheet. In addition they tend to have knowledge about regulatory information of these chemicals and the related pertinent information.
- What is certified data? A neutral body that certifies either a Data Source or a 3rd Party Chemical Assessment Company has undergone a set of criteria that was set forth by the Certifying body and the trading community. This insures that the Data Source (or a 3rd Party Chemical Assessment Company) is following properly documented procedures. Also, there are security measures needed for 3rd Party Chemical Assessment Companies who handle propriety and trade secret information. The Certifying body validates that these security measures are in place. The Certifying body audits the companies based upon the trading communities needs for audits.

30.3 How will this work?

Figure 30-1 Chemical Ingredient Data Process Flow

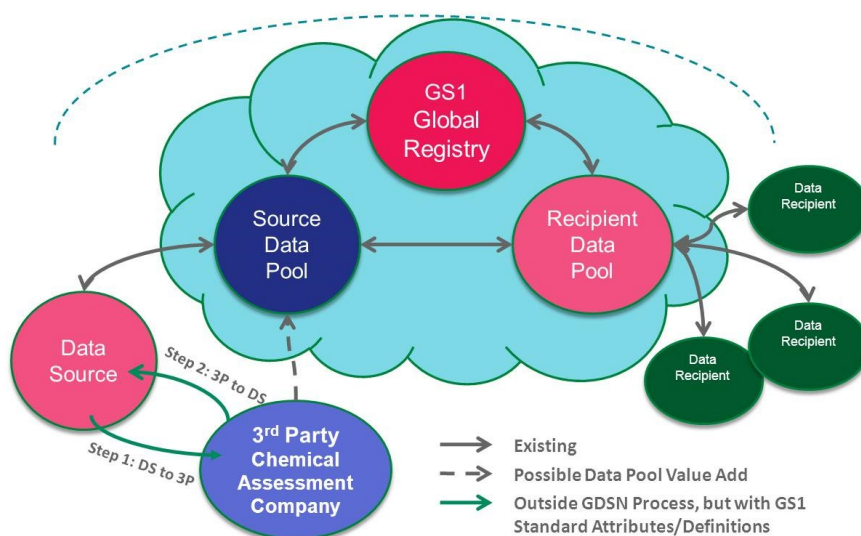

30.4 Prerequisite

In some markets the 3rd Party Chemical Assessment Company or the Data Source may need to be certified for Chemical Data Processes and Accuracy by a Certifying Body. Contact your GS1 Member organisation for further information.

If the Data Source (DS) Requires a 3rd Party Chemical Assessment Company (3P)

Step 1: DS to 3P – In order for a 3P to be able to deliver the appropriate, relevant and timeliness of data into the network, there is an initial feed a DS would need to send to a 3P. One should contact a 3P they will be working with to meet those requirements.

Step 2: 3P Deliver of Assessment – the 3P would deliver all of the required relevant information in to potential ways.

- The 3P delivers the chemical data to the DS and the DS then populates the data into the GDSN.
- The 3P is a data proxy that supplements the appropriate data in the GDSN on behalf of the DS and in agreement with the DS, (Check with your data pool on the viability of this option).

If the Data Source does not require a 3rd Party Chemical Assessment Company, then they are responsible to supply the required data to meet the Data Recipient’s business requirements. The required data would be agreed to by both Data Source and Data Recipient.

There are four basic process requirements to keep in mind when either choosing a 3rd Party Chemical Assessment Company (or supplying data as a Data Source directly):

1. Data needs to be complete
2. Data needs to be accurate
3. Data needs to be reported in a timely manner
4. (3P only) Data needs security for formulation information

30.5 Implementation Procedures

Since the Chemical Ingredient Information covers a variety of business information, this document will be broken down by

Key for table:

- **M** – Mandatory from technical perspective

- **O** – Optional for both Business Process and technical
- **BM** – Business Mandatory Should populate to process data as best practice, Most times is Mandatory from a trading partner recipient perspective
- **C** – Conditional Mandatory to populate, if another attribute is populated

30.6 Recipient Process Steps

Recipient should follow normal GDS process of subscription to data source. In normal GDS process the chemical data would be supplied when available.

But should the recipient need chemical data or resent as the chemical data may have been supplied prior to the recipient being ready, a recipient can request a RFCIN for chemical data.

Request for Catalogue Item Notification	
Attribute	Example
Is Reload	TRUE
Is Reload Reason Code	CHEMICAL_INGREDIENT_RELOAD

30.7 Data Source Process Steps

30.7.1 Chemical Certification Information

As previously mentioned, the recipients in some markets may require the chemical data is Certified by a third party. The data in this section is what is populated for these fields.

30.7.1.1 Pre-Requirement

- 3rd Party Chemical Assessment Company or Self Certifying companies must have completed certification of their processes.
- 3rd Party Chemical Assessment Company or Self Certifying companies must have completed chemical assessment of the trade item.

30.7.1.2 When Would I Use This?

As previously mentioned, the recipients in some markets may require the chemical data is Certified by a third party. The data in this section is what is populated for these fields.

- **Note:** This class allows the ability to associated pertinent documents using the Referenced File Information Class.

30.7.1.3 How To?

Table 30-1

Release 3.1				
Certification Information Module/Class	Attribute	Definition	Business Guidance (This class is optional but if data is populated, then Mandatory/Optional must be followed)	M/O/BM
<p>Note: Certification Information can be repeated so you may have multiple assessment companies and additionally a self-certified company do a chemical assessment of the trade item. This does no way reference which data was certified by which company.</p>				

Release 3.1				
Certification Information	Certification Organisation Identifier	The identification of the organisation that issued the certificate number confirming that the Trade Item has gone through certification.	This would be the GLN of the 3 rd party assessment company or if self-certified the GLN of the data source company.	BM
Certification Information	Certification Agency	Name of the organisation issuing the certification standard or other requirement being met. Free text field. Example: European Union.	Populate the name of the 3 rd party assessment company or the name of the self-certified data source	O
Note: Certification is capable of being repeated. Therefore you may have multiple Assessments for a trade item by 1 assessment company or self-certified company				
Certification Sub-class	Certification Identification	A certificate number issued by the 3 rd Party to confirm that the Trade Item has gone through chemical evaluation.	This data would be provided by 3 rd party assessment company or if self-certified generated based upon internal process. This is a reference indicative of the assessment being completed by the certified company.	BM
Certification Sub-class	Certification Assessment Date Time	The date and time that an assessment was performed on a Trade Item that led to a certification.	This data would be provided by 3 rd party assessment company or if self-certified generated based upon internal process. This allows the recipient to understand the latest assessment. If the data changes, it should be assumed that this should change also.	BM

Table 30-2 Single company / 1 or 2 assessments

Example 1: Single company / 1 or 2 assessments	
Certification Information: If you have 2 assessments by the different companies, repeat the below the whole grouping of information for each company.	
1 st Assessment	
Certification Organisation Identifier	1234567890123
Certification Agency	XYZ Chemicals Systems
Certification: If you have 2 assessments by the same company, repeat the below grouping of information.	
Chemical Evaluation Certificate Identification (certificationIdentification)	KKL998276
Certification Assessment Date Time (certificationAssessmentDateTime)	2012-07-20T12:00:00.000
Chemical Evaluation Certificate Identification (certificationIdentification)	KML162879
Certification Assessment Date Time (certificationAssessmentDateTime)	2013-08-20T12:00:00.000
2nd Assessment	
Certification Organisation Identifier	9876543210987
Certification Agency	ABC Certify U Right
Certification	
Chemical Evaluation Certificate Identification (certificationIdentification)	BBCL0L090
Certification Assessment Date Time (certificationAssessmentDateTime)	2013-12-08T12:00:00.000

30.7.2 Chemical Regulation Information

The information populated here represents different ways to look at Chemical Regulation Information.

1. By a Country or Regional Regulation (i.e. EU Commission)
2. By a Province/State or municipality regulations
3. For these types of regulation there is the ability to state just simply the regulation for the trade item itself, or the regulation can also be stated by which chemical ingredients apply to a regulation.

30.7.2.1 Pre-Requisite

3rd Party Chemical Assessment Company or Self Certifying companies must have enough knowledge about regulations to support recipient's needs. Some may only need Country/Regional regulations but some require Province/State or even as detailed as a municipality. Check with your trading partners.

30.7.2.2 When Would I Use This?

To send regulatory information about a trade item and/or specific chemical ingredients that apply to a regulation.

30.7.3 Registration Information

Some trade items must be registered with some official agency in order to sell the product in a market. Sometimes these are governmental agencies and sometimes they are 3rd party registrations

30.7.3.1 Pre-Requisite

You should have the registration identification or number available prior to populating this data.

30.7.3.2 When Would I Use This?

To send trade item registration information when the product is registered with an agency

30.7.3.3 How To?

Release 3.1				
Chemical Ingredient Ext /Class	Attribute	Definition	Business Guidance (This class is optional but if data is populated, then Mandatory/Optional must be followed)	M/O/BM
Registration Information	Registration Agency	An agency that issues registration numbers for any chemical that is contained within the product for example the United States Environmental Protection Agency.	The would be a text version of the registration agency name like US EPA, EU Commission, The State of California, etc. For each agency and registration this whole class is repeated.	M
Registration Information	Registration End Date Time	The last date that the registration number is valid.	This would mean the date the registration with the agency expires. The product may be renewed with a new date and that should be reflected with either a new subclass as the registration number would be different.	O
Registration Information	Registration Number	A registration number for any chemical that is contained within the product for example any insecticides, herbicides, rodenticides, fungicides, etc.	The number that was assigned by the agency for registration of the products.	O

Release 3.1				
Registration Information	Restriction Description	A description on any restrictions on usage for example locations where a pesticide cannot be sold.	This could be restrictions by age, or selling in a market or any type of restriction.	0

Table 30-3 Registration of product about to expire and introducing new number.

Example 1 Registration of product about to expire and introducing new number.	
Attribute	Example
Registration Agency	US EPA
Registration End Date Time	2012-12-31T23:59:00.000
Registration Number	LLL123456789
Restriction Description	Cannot sell in bulk
Registration Agency	US EPA
Registration End Date Time	2013-12-31T23:59:00.000
Registration Number	THL987655279
Restriction Description	Cannot sell in bulk

30.7.4 Chemical Supporting Documents

If there is a need to supply supporting documents, here is a brief summary of where to populate the appropriate types of data.

- **Important:** Note we will not discuss how to populate the fields or who to use the **Referenced File Information Class**. This is a smaller, trimmed down class of the External File Information Class.

30.7.4.1 Pre-Requirement

You must have the appropriate documents stored on a server to be accessible to the recipient via download from a link.

30.7.4.2 When Would I Use This?

To pass a link to a document supporting some information exchanged in the Chemical Ingredient Extensions

30.7.4.3 How To?

There are 3 Referenced File Information points related to Chemical Ingredients

- At the Trade Item Level for overall documents you would want to populate the link here
- Within the Certification Class. Here you would pass the link to certification documents or the Chemical Assessment Summary Sheets
- Within the Safety Data Sheet Information class. Here is where you would populate a link to a safety data sheet or MSDS sheet

Example 1 Referenced File Information	
Attribute	Example

Example 1 Referenced File Information	
Referenced File Type Code	SDS
Content Description	Safety Data Sheet for product x
File Creation Program	
File Effective End Date Time	
File Effective Start Date Time	2013-11-21T00:00
File Format Description	
File Format Name	PDF
File Name	ProductXSDS.PDF
File Version	1.3
Uniform Resource Identifier	http://www.download.com/pdf/productx/ProductXSDS.PDF

30.7.5 Safety Data Sheet Information

This class consists of some of the information about a product concerning what is contained on a Safety Data Sheet (SDS). The other information that may be contained on a Safety Data Sheet would be contained in other classes.

- Basic Information
 - Handling, Storage and Accidental Procedure
 - Volatile Organic Compounds
 - Toxicology
 - First Aid
- Chemical Information (Ingredients)
- Storage Compatibility
- Hazardous Waste
- Protective Equipment
- Fire Fighting
- Chemical Properties
- GHS
- REACH

30.7.5.1 Pre-Requisite

A safety data sheet should have been created or in development. This data should replicate what is contained on the safety data sheet for the trade item.

- **Important:** Note that 1 safety data sheet may apply to multiple GTINs. A safety data sheet is sometimes created for a product formulation. That product may come in multiple sizes therefore the data would be the same for multiple GTINs.
- **Important:** A GTIN can also have multiple Safety Data Sheets if:
 - a GTIN has multiple formulations during a normal product life cycle
 - a GTIN contains components and each component could have a different Safety Data Sheet

30.7.5.2 When Would I Use This?

To send trade safety data sheet information electronically

30.7.5.3 How To?

This chapter provides guidance on how to exchange Unique Formula Identifier (UFI) via GDSN. More information about what is UFI can be found in EU Regulation 2017/542 amending Regulation (EC) No 1272/2008 of the European Parliament and of the Council on classification, labelling and packaging of substances and mixtures by adding an Annex on harmonised information relating to emergency health response.

To provide UFI, please use the attribute `chemicalIngredientScheme` in `safetyDataSheetModule`. When using this attribute, other dependent attributes shall be used as well. This is illustrated by the table below.

The table below shows an example of sharing following UFI via GDSN: H563-L90S-R783-J823. Value in the attribute `chemicalIngredientIdentification` is different for every UFI, value in `chemicalIngredientScheme` is always UFI for any UFI.

Table 30-4 Exchanging UFI via GDSN.

Data Attribute Name	Sample XML Value
<code>chemicalIngredientScheme</code>	<code><chemicalIngredientScheme>UFI</chemicalIngredientScheme></code>
<code>chemicalIngredientIdentification</code>	<code><chemicalIngredientIdentification>H563-L90S-R783-J823</chemicalIngredientIdentification></code>

```
<safety_data_sheet:safetyDataSheetModule>
  <safetyDataSheetInformation>
    <chemicalInformation>
      <chemicalIngredientScheme>UFI</chemicalIngredientScheme>
      <chemicalIngredient>
        <chemicalIngredientIdentification>H563-L90S-R783-
          J823</chemicalIngredientIdentification>
      </chemicalIngredient>
    </chemicalInformation>
  </safetyDataSheetInformation>
</safety_data_sheet:safetyDataSheetModule>
```

31 Attributes for “isTradeItem”

This section provides best practice guidance on the usage of eight “isTradeItem” attributes which exist in the GDSN. In addition to the attribute definitions that are already provided in the [GS1 Navigator, GDSN](#), this section offers details for the typical user to better understand how they are implemented.

The eight “isTradeItemA” are as follows:

- `isTradeItemABaseUnit` (section [31.3](#))
- `isTradeItemAConsumerUnit` (section [31.4](#))
- `isTradeItemAVariableUnit` (section [31.5](#))
- `isTradeItemADisplayUnit` (section [31.6](#))
- `isTradeItemADespatchUnit` (section [31.7](#))
- `isTradeItemAnOrderableUnit` (section [31.8](#))
- `IsTradeItemAnInvoiceUnit` (section [31.9](#))
- `isTradeItemNonPhysical` (section [31.10](#))

31.1 Pre-requisites

This work has the pre-requisite that the user understands the GDSN standards, choreography and the various trading partners therein engaged.

31.2 When Would I Use This?

This guide would be used whenever any of these eight attributes are communicated within the GDSN publications.

31.3 isTradeItemABaseUnit

Attribute Name	isTradeItemABaseUnit
Attribute Definition	See GS1 Navigator, GDSN for the latest definition.
Target Market Applicability	Global
Trading Partner Neutral Status	T.P. Neutral
DataType	Boolean
Mandatory/Optional/Dependent (M/O/D)	M by validation rule.
Multiplicity/Occurrences	0..1

31.3.1 Implementation Guidance/Validations/Business Rules

Validation rules using isTradeItemABaseUnit can be found in the [BMS GDSN Validation Rules](#).

31.3.2 Example

Pre-packed Fixed Weight Consumer Trade Package with GTIN encoded in the barcode (EAN/UPC)

Consumer Unit	GTIN: 00016000423442	IsTradeItemABaseUnit = True
Case	GTIN: 10016000423449	IsTradeItemABaseUnit = False

31.4 isTradeItemAConsumerUnit

Attribute Name	isTradeItemAConsumerUnit
Attribute Definition	See GS1 Navigator, GDSN for the latest definition.
Target Market Applicability	Global
Trading Partner Neutral Status	T.P. Neutral
DataType	Boolean
Mandatory/Optional/Dependent (M/O/D)	M by validation rule.
Multiplicity/Occurrences	0..1

- **Note:** For additional information please refer to * MERGEFORMAT [Appendix 2: Fresh Foods](#) of the **GDS Trade Item Implementation Guide**.

31.4.1 Implementation Guidance/Validations/Business Rules

Validation rules using isTradeItemAConsumerUnit can be found in the [BMS GDSN Validation Rules](#). In addition the following business rules apply to isTradeItemAConsumerUnit.

- There can be more than one consumer unit in one hierarchy

31.4.2 Example

Case of Granola Bars; 12 packs (consumer units) in the case with 5 granola bars in each consumer unit.

31.5 isTradeItemAVariableUnit

Attribute Name	isTradeItemAVariableUnit
Attribute Definition	See GS1 Navigator, GDSN for the latest definition.
Target Market Applicability	Global
Trading Partner Neutral Status	T.P. Neutral
Data Type	Boolean
Mandatory/Optional/Dependent (M/O/D)	M by validation rule.
Multiplicity/Occurrences	0..1

- **Note:** For additional information please refer to [Section 16: Variable Measure for Net Content.](#)

31.5.1 Implementation Guidance/Validations/Business Rules:

Validation rules using isTradeItemAVariableUnit can be found in the BMS GDSN Validation Rules. In addition the following business rules apply to isTradeItemAVariableUnit.

- This attribute is mandatory in the GDSN CIN (Item Sync) message.
- Yes/True = Variable, No/False = Fixed
- If isTradeItemAVariableUnit is true, then the weight specified in netWeight is interpreted as an average.

31.5.2 Example

A trade item which is a case of chicken which has a consistent weight, but variable count of 12 to 18 pieces would have the following information populated:

netContent: 15 PCS; 11 Kg

netWeight: 11 Kg

isTradeItemAVariableUnit: TRUE

grossWeight: 11.2 Kg

Description Fields: "...12-18 Count..."

31.6 isTradeItemADisplayUnit

Attribute Name	isTradeItemADisplayUnit
Attribute Definition	See GS1 Navigator, GDSN for the latest definition.
Target Market Applicability	Global
Trading Partner Neutral Status	T.P. Neutral
Data Type	Boolean
Mandatory/Optional/Dependent (M/O/D)	Optional
Multiplicity/Occurrences	0..1

- **Note:** For additional information please refer to [Section 4: Trade Item Unit Descriptors.](#)

31.6.1 Implementation Guidance/Validations/Business Rules:

- A display unit is an orderable unit
 - IsTradeItemAnOrderableUnit is Yes/true
 - There can be more than one ordering unit in one hierarchy.
- A display unit has one or multiple child items that are consumer units.
- A display unit may be at any level in the hierarchy excluding BASE_UNIT or EACH.

31.6.2 Example

tradeItem Unit Descriptor	Description	GTIN
Pallet	72 Toy Cars	20012345678909
Case	12 Toy Cars	10012345678901
Each	1 Toy Car	00012345678905

GTIN 20012345678909 – Pallet: isTradeItemADisplayUnit – False/No

GTIN 10012345678901 – Case: isTradeItemADisplayUnit – True/Yes

GTIN 00012345678905 – Each isTradeItemADisplayUnit – False/No

31.7 isTradeItemADespatchUnit

Attribute Name	isTradeItemADespatchUnit
Attribute Definition	See GS1 Navigator, GDSN for the latest definition.
Target Market Applicability	Global/Local
Trading Partner Neutral Status	T.P.Neutral & T.P.Dependent
DataType	Boolean
Mandatory/Optional/Dependent (M/O/D)	M by validation rule.
Multiplicity/Occurrences	0..1

31.7.1 Implementation Guidance/Validations/Business Rules

Validation rules using isTradeItemADespatchUnit can be found in the [BMS GDSN Validation Rules](#). In addition the following business rules apply to isTradeItemADespatchUnit.

- This attribute is mandatory in the GDSN CIN (Item Sync) message.
- There can be more than one despatch unit in one hierarchy.

31.7.2 Example

tradeItem Unit Descriptor	Description	GTIN
CS	12 Toy Cars	12345900048215
EA	1 Toy Car	0234590004218

Case level GTIN 12345900048215 – isTradeItemADespatchUnit = True

Each level GTIN 0234590004218 – isTradeItemADespatchUnit = False

31.8 isTradeItemAnOrderableUnit

Attribute Name	isTradeItemAnOrderableUnit
Attribute Definition	See GS1 Navigator, GDSN for the latest definition.

Attribute Name	isTradeItemAnOrderableUnit
Target Market Applicability	Global/Local
Trading Partner Neutral Status	T.P.Neutral & T.P.Dependent
Data Type	Boolean
Mandatory/Optional/Dependent (M/O/D)	M by validation rule.
Multiplicity/Occurrences	0..1

31.8.1 Implementation Guidance/Validations/Business Rules

Validation rules using isTradeItemAnOrderableUnit can be found in the [BMS GDSN Validation Rules](#). In addition the following business rules apply to isTradeItemAnOrderableUnit.

- In the GDSN CIN (Item Sync) message, a hierarchy must include at least one GTIN where Ordering Unit Indicator = Yes/true
- There can be more than one ordering unit in one hierarchy

31.8.2 Example

tradeItem Unit Descriptor	Description	GTIN
CS	12 Toy Cars	12345900048215
EA	1 Toy Car	0234590004218

Case level GTIN 12345900048215 – isTradeItemAnOrderableUnit = True

Each level GTIN 0234590004218 – isTradeItemAnOrderableUnit = True or False

True example: Direct Store Delivery (DSD)

31.9 IsTradeItemAnInvoiceUnit

Attribute Name	isTradeItemAnInvoiceUnit
Attribute Definition	See GS1 Navigator, GDSN for the latest definition.
Target Market Applicability	Global/Local
Trading Partner Neutral Status	T.P.Neutral & T.P.Dependent
Data Type	Boolean
Mandatory/Optional/Dependent (M/O/D)	M by validation rule.
Multiplicity/Occurrences	0..1

31.9.1 Implementation Guidance/Validations/Business Rules:

Validation rules using isTradeItemAnInvoiceUnit can be found in the [BMS GDSN Validation Rules](#). In addition the following business rules apply to isTradeItemAnInvoiceUnit.

- This attribute must be marked as 'Yes/true' for at least one level of an item hierarchy
- One or more GTINs in a published hierarchy must be marked as an Invoice Unit
- This field can vary by data recipient
 - If a dataRecipientGLN is not provided, the attribute value provided will apply to ALL Data Recipients.
- One or more of the GTINs in each hierarchy must be marked as an INVOICE UNIT
- isTradeItemAnInvoiceUnit must be populated for the trade item

31.9.2 Example

tradeItem Unit Descriptor	Description	GTIN
Pallet	72 Toy Cars	20012345678909
Case	12 Toy Cars	10012345678901
Each	1 Toy Car	00012345678905

GTIN 20012345678909 – Pallet: isTradeItemAnInvoiceUnit - False

GTIN 10012345678901 – Case: isTradeItemAnInvoiceUnit - False

GTIN 00012345678905 – Each isTradeItemAnInvoiceUnit – True

or

GTIN 20012345678909 – Pallet: isTradeItemAnInvoiceUnit - False

GTIN 10012345678901 – Case: isTradeItemAnInvoiceUnit - True

GTIN 00012345678905 – Each isTradeItemAnInvoiceUnit – True

31.10 isTradeItemNonPhysical

Attribute Name	isTradeItemNonphysical
Attribute Definition	See GS1 Navigator, GDSN for the latest definition.
Target Market Applicability	Global
Trading Partner Neutral Status	T.P. Neutral
Data Type	Boolean
Mandatory/Optional/Dependent (M/O/D)	Optional
Multiplicity/Occurrences	0..1

31.10.1 Validation rules using isTradeItemAPhysicalUnit can be found in the BMS GDSN Validation Rules.

tradeItem Unit Descriptor	Description	GTIN
EA	Digital Movie Download	00012345123455

Each level GTIN 00012345123455 – isTradeItemNonPhysical = True

grossWeight = 'null'

height = 'null'

width = 'null'

depth = 'null'

32 Food Labels

A common requirement for food operators to communicate to retailers' information regarding food label information for a trade item. GDSN standards support several scenarios for passing this information. This topic illustrates the possibilities with examples.

32.1 Pre-Requisite

It is important to understand any regulatory requirements supersede anything documented here. The examples used in this Implementation Guide contain fictitious data. Users are advised to contact their data pool and/or local GS1 MO for further information on how the attributes are used in particular countries.

32.2 When Would I Use This?

When there is a need to communicate information identified on a food item’s label through GDS.

32.3 Communicating Food Label Information

Food label information can be communicated within several GDS modules.

The following types of information can be communicated on a Food Label:

- Allergen Information
- Nutrition Information
- Ingredient Information
- Other product-specific information such as Storage Instructions, Specific Warnings, Claims, etc.

32.4 Example 1: All Nutrient Information

The data builds from image to image. There will be a full food label and attributes in section [32.6 Example 3](#). As we build an image, the data from previous image will be greyed out.

- **Note:** The data used in these examples is fictitious and should not be used as real data.

32.4.1 Image 1

Usually contains important information that states the basis for all nutrient information.

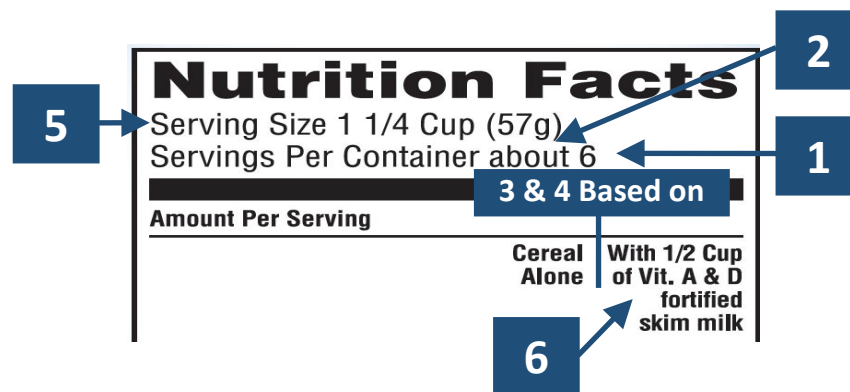

1	Number Of Servings Per Package	(O) The number of servings is usually on label
2	Number Of Servings Per Package Measurement Precision Code	(O) Use closest to available code. Additional codes being added regularly as these are regulatory in nature. Basically any word that qualifies the number of servings per package.
3	Preparation State Code	(M) Evaluate if any preparation that effects Nutritional information. This is not on the label but should be determined
4	Nutrient Basis Quantity Type Code	(O) This specifies if the nutrient information is by serving or Measure. Measure may be per 100 grams, if the Serving Size is NOT 100 grams
	Nutrient Basis Quantity	(O) Usually the same value as serving size unless the basis is a measure like 100 grams
5	Serving Size	(O) This information and class will be repeated for each serving size and type that effects Nutritional Label. Quantitative information
6	Serving Size Description	(O) This information and class will be repeated for each serving size and type that effects Nutritional Label. Qualitative information

Table 32-1 Example 1, Image 1 Attribute Information

Module/Class/Attribute Name	User Friendly Name	Value
Food And Beverage Preparation Serving Module		
numberOfServingsPerPackage	Number Of Servings Per Package	6
numberOfServingsPerPackage MeasurementPrecisionCode	Measurement Precision Code for Number Of Servings Per Package	APPROXIMATELY
Nutritional Information Module		
Nutrient Header Class		
preparationStateCode	Preparation State Code	UNPREPARED
nutrientBasisQuantityTypeCode	Nutrient Basis Quantity Type Code	BY_SERVING
nutrientBasisQuantity	Nutrient Basis Quantity <i>G21 = Code for cup</i>	1.25 G21
servingSize	Serving Size	1.25 G21
servingSizeDescription	Serving Size Description (formerly Household Serving Size)	Cereal Alone
preparationStateCode	Preparation State Code	PREPARED
nutrientBasisQuantityTypeCode	Nutrient Basis Quantity Type Code	BY_SERVING
nutrientBasisQuantity	Nutrient Basis Quantity	1.25 G21
servingSize	Serving Size	1.25 G21
servingSizeDescription	Serving Size Description	With ½ Cup of Vit. A & D fortified skim milk

32.4.2 Image 2

Next all detail nutrient information will be entered

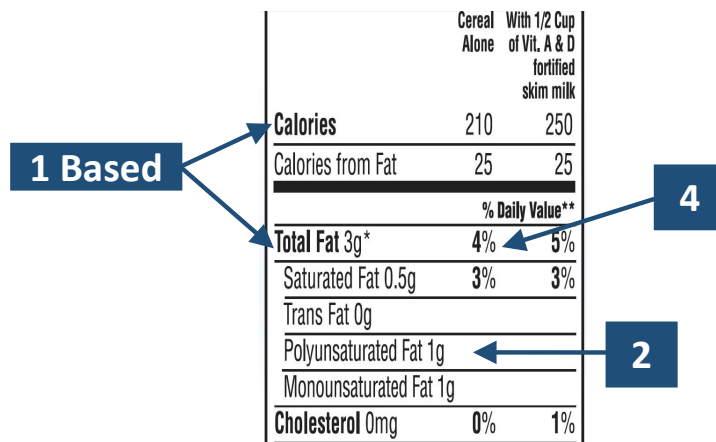

1	Nutrient Type Code	(M) This is the UN Infoods code that represents the nutrients
2	Quantity Contained	(O) When you see an amount with a measure that is this attribute
3	Measurement Precision Code	(O) This is used in conjunction with Quantity Contained. For example < 3g, about 3g etc. (Not shown)
4	Daily Value Intake Percent	(O) The percentage the nutrient makes up of the daily value intake reference based on the nutrient basis quantity + Serving Size Description
5	AVP: Daily Value Intake Percent Measurement Precision Code	(O) This is used in conjunction with Daily Value Intake Percent. For example < 3%, about 1% etc. (Not shown)



	Cereal Alone	With 1/2 Cup of Vit. A & D fortified skim milk
Calories	210	250
Calories from Fat	25	25
% Daily Value**		
Total Fat 3g*	4%	5%
Saturated Fat 0.5g	3%	3%
Trans Fat 0g		
Polyunsaturated Fat 1g		
Monounsaturated Fat 1g		
Cholesterol 0mg	0%	1%

Sodium 210mg	9%	11%
Potassium 250mg	7%	13%
Total Carbohydrate 43g	14%	16%
Dietary Fiber 6g	23%	23%
Soluble Fiber 2g		
Sugars 9g		
Other Carbohydrate 28g		
Protein 7g	8%	10%
Vitamin A	10%	15%
Vitamin C	10%	10%
Calcium	10%	25%

Iron	90%	90%
Vitamin E	10%	10%
Thiamin	25%	30%
Riboflavin	25%	40%
Niacin	25%	25%
Vitamin B6	25%	25%
Folic Acid	100%	100%
Phosphorus	25%	40%
Magnesium	20%	25%
Zinc	25%	30%

Table 32-2 Example 1, Image 2 Attribute Information

Module/Class/Attribute Name	User Friendly Name	Value <i>(description in italics)</i>
Food And Beverage Preparation Serving Module		
numberOfServingsPerPackage	Number Of Servings Per Package	6
numberOfServingsPerPackage MeasurementPrecisionCode	Measurement Precision Code for Number Of Servings Per Package	APPROXIMATELY
Nutritional Information Module		
Nutrient Header Class		
preparationStateCode	Preparation State Code	UNPREPARED
nutrientBasisQuantityTypeCode	Nutrient Basis Quantity Type Code	BY_SERVING
nutrientBasisQuantity	Nutrient Basis Quantity <i>G21 = Code for cup</i>	1.25 G21
servingSize	Serving Size	1.25 G21
servingSizeDescription	Serving Size Description	Cereal Alone
Nutrient Detail Class		
nutrientTypeCode	Nutrient Type Code	ENER-: <i>Calories</i>
quantityContained	Nutrient Quantity and Unit of Measure	210 E14 Kilocalorie / Calorie*
Nutrient Detail (Loop 1.2)	Nutrient Type Code	ENERPF: <i>Calories from Fat</i>
quantityContained	Quantity Contained	25 E14 Kilocalorie / Calorie*
nutrientTypeCode	Nutrient Type Code	FATNLEA: <i>Total Fat</i>
quantityContained	Nutrient Quantity and Unit of Measure	3 GRM
dailyValueIntakePercent	Daily Value Intake Percent	4 - % of DVI
nutrientTypeCode	Nutrient Type Code	FASAT: <i>Saturated Fat</i>
quantityContained	Nutrient Quantity and Unit of Measure	0.5 GRM
dailyValueIntakePercent	Daily Value Intake Percent	3 - % of DVI
nutrientTypeCode	Nutrient Type Code	FATRNL: <i>Trans Fat</i>
quantityContained	Nutrient Quantity and Unit of Measure	0 GRM
nutrientTypeCode	Nutrient Type Code	FAPU: <i>Polyunsaturated Fat</i>
quantityContained	Nutrient Quantity and Unit of Measure	1 GRM
nutrientTypeCode	Nutrient Type Code	FAMS: <i>Monounsaturated Fat</i>
quantityContained	Nutrient Quantity and Unit of Measure	1 GRM
nutrientTypeCode	Nutrient Type Code	CHOL-: <i>Cholesterol</i>
quantityContained	Nutrient Quantity and Unit of Measure	0 MGM
dailyValueIntakePercent	Daily Value Intake Percent	0 - % of DVI
nutrientTypeCode	Nutrient Type Code	NA: <i>Sodium</i>
quantityContained	Nutrient Quantity and Unit of Measure	210 MGM
dailyValueIntakePercent	Daily Value Intake Percent	9 - % of DVI
nutrientTypeCode	Nutrient Type Code	K: <i>Potassium</i>
quantityContained	Nutrient Quantity and Unit of Measure	250 MGM
dailyValueIntakePercent	Daily Value Intake Percent	7 - % of DVI
nutrientTypeCode	Nutrient Type Code	CHO-: <i>Total Carbohydrate</i>
quantityContained	Nutrient Quantity and Unit of Measure	43 GRM

Module/Class/Attribute Name	User Friendly Name	Value <i>(description in italics)</i>
dailyValueIntakePercent	Daily Value Intake Percent	14 - % of DVI
nutrientTypeCode	Nutrient Type Code	FIBTSW: <i>Dietary Fiber</i>
quantityContained	Nutrient Quantity and Unit of Measure	6 GRM
dailyValueIntakePercent	Daily Value Intake Percent	23 - % of DVI
nutrientTypeCode	Nutrient Type Code	FIBSOL: <i>Soluble Fiber</i>
quantityContained	Nutrient Quantity and Unit of Measure	2 GRM
nutrientTypeCode	Nutrient Type Code	SUGAR-: <i>Sugars</i>
quantityContained	Nutrient Quantity and Unit of Measure	9 GRM
nutrientTypeCode	Nutrient Type Code	CHOU: <i>Other Carbohydrate (Carbohydrate Unspecified)</i>
quantityContained	Nutrient Quantity and Unit of Measure	28 GRM
nutrientTypeCode	Nutrient Type Code	PRO-: <i>Protein</i>
quantityContained	Nutrient Quantity and Unit of Measure	7 GRM
dailyValueIntakePercent	Daily Value Intake Percent	8 - % of DVI
nutrientTypeCode	Nutrient Type Code	VITA-: <i>Vitamin A</i>
dailyValueIntakePercent	Daily Value Intake Percent	10
nutrientTypeCode	Nutrient Type Code	VITC-: <i>Vitamin C</i>
dailyValueIntakePercent	Daily Value Intake Percent	10 - % of DVI
nutrientTypeCode	Nutrient Type Code	CA: <i>Calcium</i>
dailyValueIntakePercent	Daily Value Intake Percent	10 - % of DVI
nutrientTypeCode	Nutrient Type Code	FE: <i>Iron</i>
dailyValueIntakePercent	Daily Value Intake Percent	90 - % of DVI
nutrientTypeCode	Nutrient Type Code	VITE-: <i>Vitamin E</i>
dailyValueIntakePercent	Daily Value Intake Percent	10 - % of DVI
nutrientTypeCode	Nutrient Type Code	THIA: <i>Thiamin</i>
dailyValueIntakePercent	Daily Value Intake Percent	25 - % of DVI
nutrientTypeCode	Nutrient Type Code	RIBF: <i>Riboflavin</i>
dailyValueIntakePercent	Daily Value Intake Percent	25 - % of DVI
nutrientTypeCode	Nutrient Type Code	NIA: <i>Niacin</i>
dailyValueIntakePercent	Daily Value Intake Percent	25 - % of DVI
nutrientTypeCode	Nutrient Type Code	VITB6-: <i>Vitamin B6</i>
dailyValueIntakePercent	Daily Value Intake Percent	25 - % of DVI
nutrientTypeCode	Nutrient Type Code	FOLAC: <i>Folic Acid</i>
dailyValueIntakePercent	Daily Value Intake Percent	100 - % of DVI
nutrientTypeCode	Nutrient Type Code	P: <i>Phosphorus</i>
dailyValueIntakePercent	Daily Value Intake Percent	25 - % of DVI
nutrientTypeCode	Nutrient Type Code	MG: <i>Magnesium</i>
dailyValueIntakePercent	Daily Value Intake Percent	20 - % of DVI
nutrientTypeCode	Nutrient Type Code	ZN: <i>Zinc</i>
dailyValueIntakePercent	Daily Value Intake Percent	25 - % of DVI
Nutrient Header Class		

Module/Class/Attribute Name	User Friendly Name	Value <i>(description in italics)</i>
preparationStateCode	Preparation State Code	PREPARED
nutrientBasisQuantityTypeCode	Nutrient Basis Quantity Type Code	BY_SERVING
nutrientBasisQuantity	Nutrient Basis Quantity <i>G21 = Code for cup</i>	1.25 G21
servingSize	Serving Size	1.25 G21
servingSizeDescription	Serving Size Description	With ½ Cup of Vit. A & D fortified skim milk
Nutrient Detail Class		
nutrientTypeCode	Nutrient Type Code	ENER-: <i>Calories</i>
quantityContained	Nutrient Quantity and Unit of Measure	250 E14 Kilocalorie / Calorie*
nutrientTypeCode	Nutrient Type Code	ENERPF: <i>Calories from Fat</i>
quantityContained	Nutrient Quantity and Unit of Measure	25 E14 Kilocalorie / Calorie*
nutrientTypeCode	Nutrient Type Code	FATNLEA: <i>Total Fat</i>
quantityContained	Nutrient Quantity and Unit of Measure	3 GRM
dailyValueIntakePercent	Daily Value Intake Percent	5 - % of DVI
nutrientTypeCode	Nutrient Type Code	FASAT: <i>Saturated Fat</i>
quantityContained	Nutrient Quantity and Unit of Measure	0.5 GRM
dailyValueIntakePercent	Daily Value Intake Percent	3 - % of DVI
nutrientTypeCode	Nutrient Type Code	FATRNL: <i>Trans Fat</i>
quantityContained	Nutrient Quantity and Unit of Measure	0 GRM
nutrientTypeCode	Nutrient Type Code	FAPU: <i>Polyunsaturated Fat</i>
quantityContained	Nutrient Quantity and Unit of Measure	1 GRM
nutrientTypeCode	Nutrient Type Code	FAMS: <i>Monounsaturated Fat</i>
quantityContained	Nutrient Quantity and Unit of Measure	1 GRM
nutrientTypeCode	Nutrient Type Code	CHOL-: <i>Cholesterol</i>
quantityContained	Nutrient Quantity and Unit of Measure	0 MGM
dailyValueIntakePercent	Daily Value Intake Percent	1 - % of DVI
nutrientTypeCode	Nutrient Type Code	NA: <i>Sodium</i>
quantityContained	Nutrient Quantity and Unit of Measure	210 MGM
dailyValueIntakePercent	Daily Value Intake Percent	11 - % of DVI
nutrientTypeCode	Nutrient Type Code	K: <i>Potassium</i>
quantityContained	Nutrient Quantity and Unit of Measure	250 MGM
dailyValueIntakePercent	Daily Value Intake Percent	13 - % of DVI
nutrientTypeCode	Nutrient Type Code	CHO-: <i>Total Carbohydrate</i>
quantityContained	Nutrient Quantity and Unit of Measure	43 GRM
dailyValueIntakePercent	Daily Value Intake Percent	16 - % of DVI
nutrientTypeCode	Nutrient Type Code	FIBTSW: <i>Dietary Fiber</i>
quantityContained	Nutrient Quantity and Unit of Measure	6 GRM
dailyValueIntakePercent	Daily Value Intake Percent	23 - % of DVI
nutrientTypeCode	Nutrient Type Code	FIBSOL: <i>Soluble Fiber</i>
quantityContained	Nutrient Quantity and Unit of Measure	2 GRM

Module/Class/Attribute Name	User Friendly Name	Value <i>(description in italics)</i>
nutrientTypeCode	Nutrient Type Code	SUGAR-: <i>Sugars</i>
quantityContained	Nutrient Quantity and Unit of Measure	9 GRM
nutrientTypeCode	Nutrient Type Code	CHOU: <i>Other Carbohydrate (Carbohydrate Unspecified)</i>
quantityContained	Nutrient Quantity and Unit of Measure	28 GRM
nutrientTypeCode	Nutrient Type Code	PRO-: <i>Protein</i>
quantityContained	Nutrient Quantity and Unit of Measure	7 GRM
dailyValueIntakePercent	Daily Value Intake Percent	10 - % of DVI
nutrientTypeCode	Nutrient Type Code	VITA-: <i>Vitamin A</i>
dailyValueIntakePercent	Daily Value Intake Percent	15 - % of DVI
nutrientTypeCode	Nutrient Type Code	VITC-: <i>Vitamin C</i>
dailyValueIntakePercent	Daily Value Intake Percent	10 - % of DVI
nutrientTypeCode	Nutrient Type Code	CA: <i>Calcium</i>
dailyValueIntakePercent	Daily Value Intake Percent	25 - % of DVI
nutrientTypeCode	Nutrient Type Code	FE: <i>Iron</i>
dailyValueIntakePercent	Daily Value Intake Percent	90 - % of DVI
nutrientTypeCode	Nutrient Type Code	VITE-: <i>Vitamin E</i>
dailyValueIntakePercent	Daily Value Intake Percent	10 - % of DVI
nutrientTypeCode	Nutrient Type Code	THIA: <i>Thiamin</i>
dailyValueIntakePercent	Daily Value Intake Percent	30 - % of DVI
nutrientTypeCode	Nutrient Type Code	RIBF: <i>Riboflavin</i>
dailyValueIntakePercent	Daily Value Intake Percent	40 - % of DVI
nutrientTypeCode	Nutrient Type Code	NIA: <i>Niacin</i>
dailyValueIntakePercent	Daily Value Intake Percent	25 - % of DVI
nutrientTypeCode	Nutrient Type Code	VITB6-: <i>Vitamin B6</i>
dailyValueIntakePercent	Daily Value Intake Percent	25 - % of DVI
nutrientTypeCode	Nutrient Type Code	FOLAC: <i>Folic Acid</i>
dailyValueIntakePercent	Daily Value Intake Percent	100 - % of DVI
nutrientTypeCode	Nutrient Type Code	P: <i>Phosphorus</i>
dailyValueIntakePercent	Daily Value Intake Percent	40 - % of DVI
nutrientTypeCode	Nutrient Type Code	MG: <i>Magnesium</i>
dailyValueIntakePercent	Daily Value Intake Percent	25 - % of DVI
nutrientTypeCode	Nutrient Type Code	ZN: <i>Zinc</i>
dailyValueIntakePercent	Daily Value Intake Percent	30 - % of DVI

32.5 Example 2: Daily Value Intake and Daily Value Table Footnote

- **Important:** The Daily Value Intake Footnote is required on labels depending regulatory requirements and packaging size. Since this data may be standard for every product depending regulatory requirements there is no need to exchange. This data is usually available on regulatory websites.

Daily Value Table Footnote not available in GDS

*Amount in Cereal. One half cup skim milk contributes an additional 65mg Sodium, 200mg Potassium, 6g Total Carbohydrate (6g Sugars), and 4g Protein.
 **Percent Daily Values are based on a 2,000 calorie diet. Your daily values may be higher or lower depending on your calorie needs

	Calories:	2,000	2,500
Total Fat	Less than	65g	80g
Sat. Fat	Less than	20g	25g
Cholesterol	Less than	300mg	300mg
Sodium	Less than	2,400mg	2,400mg
Potassium		3,500mg	3,500mg
Total Carbohydrate		300g	375g
Dietary Fiber		25g	30g
Protein		50g	65g

1

1	Daily Value Intake Reference	(O) Only part of this can be stated as field is 70 characters. Disclaimer is not considered
---	------------------------------	---

Table 32-3 Example 2 Attribute Information

Module/Class/Attribute Name	User Friendly Name	Value <i>(description in italics)</i>
Food And Beverage Preparation Serving Module		
numberOfServingsPerPackage	Number Of Servings Per Package	6
numberOfServingsPerPackage MeasurementPrecisionCode	Measurement Precision Code for Number Of Servings Per Package	APPROXIMATELY
Nutritional Information Module		
Nutrient Header Class		
dailyValueIntakeReference	Daily Value Intake Reference	Percent Daily Values are based on a 2,000 calorie diet.
preparationStateCode	Preparation State Code	UNPREPARED
nutrientBasisQuantityTypeCode	Nutrient Basis Quantity Type Code	BY_SERVING
nutrientBasisQuantity	Nutrient Basis Quantity <i>G21 == Code for cup</i>	1.25 G21
servingSize	Serving Size	1.25 G21
servingSizeDescription	Serving Size Description (formerly Household Serving Size)	Cereal Alone
Nutrient Detail Class		
nutrientTypeCode	Nutrient Type Code	ENER-: <i>Calories</i>
quantityContained	Nutrient Quantity and Unit of Measure	210 E14 Kilocalorie / Calorie*
nutrientTypeCode	Nutrient Type Code	ENERPF: <i>Calories from Fat</i>
quantityContained	Nutrient Quantity and Unit of Measure	25 E14 Kilocalorie / Calorie*
nutrientTypeCode	Nutrient Type Code	FATNLEA: <i>Total Fat</i>
quantityContained	Nutrient Quantity and Unit of Measure	3 GRM
dailyValueIntakePercent	Daily Value Intake Percent	4 - % of DVI



Module/Class/Attribute Name	User Friendly Name	Value <i>(description in italics)</i>
nutrientTypeCode	Nutrient Type Code	FASAT: <i>Saturated Fat</i>
quantityContained	Nutrient Quantity and Unit of Measure	0.5 GRM
dailyValueIntakePercent	Daily Value Intake Percent	3 - <i>% of DVI</i>
nutrientTypeCode	Nutrient Type Code	FATRN: <i>Trans Fat</i>
quantityContained	Nutrient Quantity and Unit of Measure	0 GRM
nutrientTypeCode	Nutrient Type Code	FAPU: <i>Polyunsaturated Fat</i>
quantityContained	Nutrient Quantity and Unit of Measure	1 GRM
nutrientTypeCode	Nutrient Type Code	FAMS: <i>Monounsaturated Fat</i>
quantityContained	Nutrient Quantity and Unit of Measure	1 GRM
nutrientTypeCode	Nutrient Type Code	CHOL-: <i>Cholesterol</i>
quantityContained	Nutrient Quantity and Unit of Measure	0 MGM
dailyValueIntakePercent	Daily Value Intake Percent	0 - <i>% of DVI</i>
nutrientTypeCode	Nutrient Type Code	NA: <i>Sodium</i>
quantityContained	Nutrient Quantity and Unit of Measure	210 MGM
dailyValueIntakePercent	Daily Value Intake Percent	9 - <i>% of DVI</i>
nutrientTypeCode	Nutrient Type Code	K: <i>Potassium</i>
quantityContained	Nutrient Quantity and Unit of Measure	250 MGM
dailyValueIntakePercent	Daily Value Intake Percent	7 - <i>% of DVI</i>
nutrientTypeCode	Nutrient Type Code	CHO-: <i>Total Carbohydrate</i>
quantityContained	Nutrient Quantity and Unit of Measure	43 GRM
dailyValueIntakePercent	Daily Value Intake Percent	14 - <i>% of DVI</i>
nutrientTypeCode	Nutrient Type Code	FIBTSW: <i>Dietary Fiber</i>
quantityContained	Nutrient Quantity and Unit of Measure	6 GRM
dailyValueIntakePercent	Daily Value Intake Percent	23 - <i>% of DVI</i>
nutrientTypeCode	Nutrient Type Code	FIBSOL: <i>Soluble Fiber</i>
quantityContained	Nutrient Quantity and Unit of Measure	2 GRM
nutrientTypeCode	Nutrient Type Code	SUGAR-: <i>Sugars</i>
quantityContained	Nutrient Quantity and Unit of Measure	9 GRM
nutrientTypeCode	Nutrient Type Code	CHOU: <i>Other Carbohydrate (Carbohydrate Unspecified)</i>
quantityContained	Nutrient Quantity and Unit of Measure	28 GRM
nutrientTypeCode	Nutrient Type Code	PRO-: <i>Protein</i>
quantityContained	Nutrient Quantity and Unit of Measure	7 GRM
dailyValueIntakePercent	Daily Value Intake Percent	8 - <i>% of DVI</i>
nutrientTypeCode	Nutrient Type Code	VITA-: <i>Vitamin A</i>
dailyValueIntakePercent	Daily Value Intake Percent	10 - <i>% of DVI</i>
nutrientTypeCode	Nutrient Type Code	VITC-: <i>Vitamin C</i>
dailyValueIntakePercent	Daily Value Intake Percent	10 - <i>% of DVI</i>
nutrientTypeCode	Nutrient Type Code	CA: <i>Calcium</i>
dailyValueIntakePercent	Daily Value Intake Percent	10 - <i>% of DVI</i>
nutrientTypeCode	Nutrient Type Code	FE: <i>Iron</i>



Module/Class/Attribute Name	User Friendly Name	Value (<i>description in italics</i>)
dailyValueIntakePercent	Daily Value Intake Percent	90 - % of DVI
nutrientTypeCode	Nutrient Type Code	VITE-: <i>Vitamin E</i>
dailyValueIntakePercent	Daily Value Intake Percent	10 - % of DVI
nutrientTypeCode	Nutrient Type Code	THIA: <i>Thiamin</i>
dailyValueIntakePercent	Daily Value Intake Percent	25 - % of DVI
nutrientTypeCode	Nutrient Type Code	RIBF: <i>Riboflavin</i>
dailyValueIntakePercent	Daily Value Intake Percent	25 - % of DVI
nutrientTypeCode	Nutrient Type Code	NIA: <i>Niacin</i>
dailyValueIntakePercent	Daily Value Intake Percent	25 - % of DVI
nutrientTypeCode	Nutrient Type Code	VITB6-: <i>Vitamin B6</i>
dailyValueIntakePercent	Daily Value Intake Percent	25 - % of DVI
nutrientTypeCode	Nutrient Type Code	FOLAC: <i>Folic Acid</i>
dailyValueIntakePercent	Daily Value Intake Percent	100 - % of DVI
nutrientTypeCode	Nutrient Type Code	P: <i>Phosphorus</i>
dailyValueIntakePercent	Daily Value Intake Percent	25 - % of DVI
nutrientTypeCode	Nutrient Type Code	MG: <i>Magnesium</i>
dailyValueIntakePercent	Daily Value Intake Percent	20 - % of DVI
nutrientTypeCode	Nutrient Type Code	ZN: <i>Zinc</i>
dailyValueIntakePercent	Daily Value Intake Percent	25 - % of DVI
Nutrient Header Class		
dailyValueIntakeReference	Daily Value Intake Reference	Percent Daily Values are based on a 2,000 calorie diet.
preparationStateCode	Preparation State Code	PREPARED
nutrientBasisQuantityTypeCode	Nutrient Basis Quantity Type Code	BY_SERVING
nutrientBasisQuantity	Nutrient Basis Quantity <i>G21 == Code for cup</i>	1.25 G21
servingSize	Serving Size	1.25 G21
servingSizeDescription	Serving Size Description (formerly Household Serving Size)	With ½ Cup of Vit. A & D fortified skim milk
Nutrient Detail Class		
nutrientTypeCode	Nutrient Type Code	ENER-: <i>Calories</i>
quantityContained	Nutrient Quantity and Unit of Measure	250 E14 Kilocalorie / Calorie*
nutrientTypeCode	Nutrient Type Code	ENERPF: <i>Calories from Fat</i>
quantityContained	Nutrient Quantity and Unit of Measure	25 E14 Kilocalorie / Calorie*
nutrientTypeCode	Nutrient Type Code	FATNLEA: <i>Total Fat</i>
quantityContained	Nutrient Quantity and Unit of Measure	3 GRM
dailyValueIntakePercent	Daily Value Intake Percent	5 - % of DVI
nutrientTypeCode	Nutrient Type Code	FASAT: <i>Saturated Fat</i>
quantityContained	Nutrient Quantity and Unit of Measure	0.5 GRM
dailyValueIntakePercent	Daily Value Intake Percent	3 - % of DVI
nutrientTypeCode	Nutrient Type Code	FATRNL: <i>Trans Fat</i>
quantityContained	Nutrient Quantity and Unit of Measure	0 GRM

Module/Class/Attribute Name	User Friendly Name	Value <i>(description in italics)</i>
nutrientTypeCode	Nutrient Type Code	FAPU: <i>Polyunsaturated Fat</i>
quantityContained	Nutrient Quantity and Unit of Measure	1 GRM
nutrientTypeCode	Nutrient Type Code	FAMS: <i>Monounsaturated Fat</i>
quantityContained	Nutrient Quantity and Unit of Measure	1 GRM
nutrientTypeCode	Nutrient Type Code	CHOL- : <i>Cholesterol</i>
quantityContained	Nutrient Quantity and Unit of Measure	0 MGM
dailyValueIntakePercent	Daily Value Intake Percent	1 - % of DVI
nutrientTypeCode	Nutrient Type Code	NA: <i>Sodium</i>
quantityContained	Nutrient Quantity and Unit of Measure	210 MGM
dailyValueIntakePercent	Daily Value Intake Percent	11 - % of DVI
nutrientTypeCode	Nutrient Type Code	K: <i>Potassium</i>
quantityContained	Nutrient Quantity and Unit of Measure	250 MGM
dailyValueIntakePercent	Daily Value Intake Percent	13 - % of DVI
nutrientTypeCode	Nutrient Type Code	CHO-: <i>Total Carbohydrate</i>
quantityContained	Nutrient Quantity and Unit of Measure	43 GRM
dailyValueIntakePercent	Daily Value Intake Percent	16 - % of DVI
nutrientTypeCode	Nutrient Type Code	FIBTSW: <i>Dietary Fiber</i>
quantityContained	Nutrient Quantity and Unit of Measure	6 GRM
dailyValueIntakePercent	Daily Value Intake Percent	23 - % of DVI
nutrientTypeCode	Nutrient Type Code	FIBSOL: <i>Soluble Fiber</i>
quantityContained	Nutrient Quantity and Unit of Measure	2 GRM
nutrientTypeCode	Nutrient Type Code	SUGAR-: <i>Sugars</i>
quantityContained	Nutrient Quantity and Unit of Measure	9 GRM
nutrientTypeCode	Nutrient Type Code	CHOU: <i>Other Carbohydrate (Carbohydrate Unspecified)</i>
quantityContained	Nutrient Quantity and Unit of Measure	28 GRM
nutrientTypeCode	Nutrient Type Code	PRO-: <i>Protein</i>
quantityContained	Nutrient Quantity and Unit of Measure	7 GRM
dailyValueIntakePercent	Daily Value Intake Percent	10 - % of DVI
nutrientTypeCode	Nutrient Type Code	VITA-: <i>Vitamin A</i>
dailyValueIntakePercent	Daily Value Intake Percent	15 - % of DVI
nutrientTypeCode	Nutrient Type Code	VITC-: <i>Vitamin C</i>
dailyValueIntakePercent	Daily Value Intake Percent	10 - % of DVI
nutrientTypeCode	Nutrient Type Code	CA: <i>Calcium</i>
dailyValueIntakePercent	Daily Value Intake Percent	25 - % of DVI
nutrientTypeCode	Nutrient Type Code	FE: <i>Iron</i>
dailyValueIntakePercent	Daily Value Intake Percent	90 - % of DVI
nutrientTypeCode	Nutrient Type Code	VITE-: <i>Vitamin E</i>
dailyValueIntakePercent	Daily Value Intake Percent	10 - % of DVI
nutrientTypeCode	Nutrient Type Code	THIA: <i>Thiamin</i>
dailyValueIntakePercent	Daily Value Intake Percent	30 - % of DVI

Module/Class/Attribute Name	User Friendly Name	Value <i>(description in italics)</i>
nutrientTypeCode	Nutrient Type Code	RIBF: <i>Riboflavin</i>
dailyValueIntakePercent	Daily Value Intake Percent	40 - <i>% of DVI</i>
nutrientTypeCode	Nutrient Type Code	NIA: <i>Niacin</i>
dailyValueIntakePercent	Daily Value Intake Percent	25 - <i>% of DVI</i>
nutrientTypeCode	Nutrient Type Code	VITB6-: <i>Vitamin B6</i>
dailyValueIntakePercent	Daily Value Intake Percent	25 - <i>% of DVI</i>
nutrientTypeCode	Nutrient Type Code	FOLAC: <i>Folic Acid</i>
dailyValueIntakePercent	Daily Value Intake Percent	100 - <i>% of DVI</i>
nutrientTypeCode	Nutrient Type Code	P: <i>Phosphorus</i>
dailyValueIntakePercent	Daily Value Intake Percent	40 - <i>% of DVI</i>
nutrientTypeCode	Nutrient Type Code	MG: <i>Magnesium</i>
dailyValueIntakePercent	Daily Value Intake Percent	25 - <i>% of DVI</i>
nutrientTypeCode	Nutrient Type Code	ZN: <i>Zinc</i>
dailyValueIntakePercent	Daily Value Intake Percent	30 - <i>% of DVI</i>

32.6 Example 3: Ingredients and Contact Information

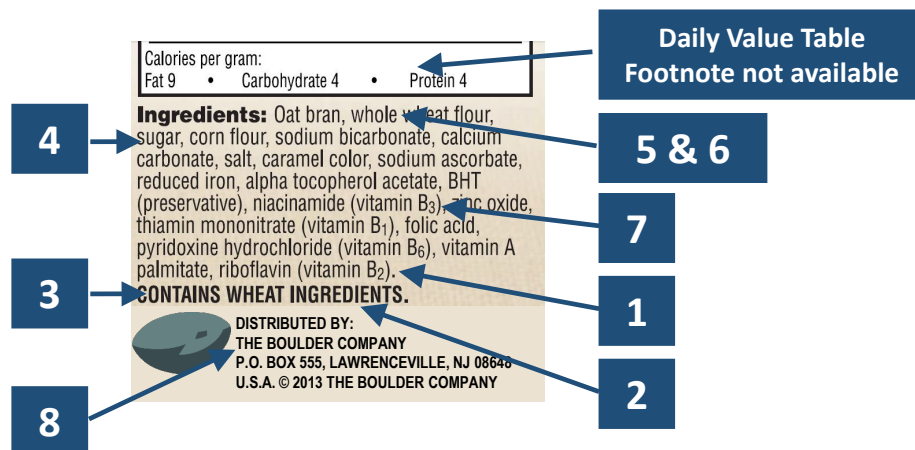

1	Allergen Statement	(O) This should be the full allergen statement usually highlighted on label
2	Allergen Type Code	(M) This is the code that represents the allergen. This is only mandatory if there is a need to send the allergen code
3	Level Of Containment Code	(M) This is the code that represents the word describing the allergen containment. These are usually regulatory meanings and definitions. This is only mandatory if there is a need to send the allergen code
4	Ingredient Statement	(O) This is the full ingredient statement. Some markets require to add the Allergen information too.
5	Ingredient Sequence	(M by validation) This is the sequence number of the ingredient in the ingredient statement.
6	Ingredient Name	(M by validation) This is just the ingredient.
7	Ingredient Purpose	(O) Describes what the ingredient is used for. It is usually in parenthesis after ingredient.
8	Brand Owner / Party Name	(O) The name and address that would be the Brand owner
9	Brand Owner / Party Address	(O) The name and address that would be the Brand owner
10	Contact Type Code	(M) This is a code to represent the type of information is supplied.

Table 32-4 Example 3 Attribute Information

Module/Class/Attribute Name	Attribute	Value <i>(description in italics)</i>
Module: TradeItem		
brandOwnerName	Brand Owner / Party Name	The Boulder Company
brandOwnerAddress	Brand Owner / Party Address	P.O. BOX 555, LAWRENCEVILLE, NJ 08648
contactTypeCode	Type of Contact <i>CXC = code for CONSUMER_SUPPORT</i>	<i>CXC: Consumer Support</i>
contactName	Contact Name	The Boulder Company
contactAddress	Contact Address	P.O. BOX 555, LAWRENCEVILLE, NJ 08648
Allergen Information Module		
allergenStatement	Allergen Statement	CONTAINS WHEAT INGREDIENTS
Allergen Class		
allergenTypeCode	Allergen Type Code	<i>UW: Wheat and it's derivatives</i>
levelOfContainmentCode	Level Of Containment Code	CONTAINS
Food And Beverage Ingredient Module		
ingredientStatement	Ingredient Statement	Oat bran, whole wheat flour, sugar, corn flour, sodium bicarbonate, calcium carbonate, salt, caramel color, sodium ascorbate, reduced iron, alpha tocopherol acetate, BHT (preservative), niacinamide (vitamin B3), zinc oxide, thiamine mononitrate (vitamin B1), folic acid, pyridoxine hydrochloride (vitamin B6), vitamin A palmitate, riboflavin (vitamin B2).
ingredientSequence	Sequence number of ingredient	01
ingredientName	Ingredient Name	Oat bran
ingredientSequence	Ingredient Sequence	02
ingredientName	Ingredient Name	whole wheat flour
ingredientSequence	Ingredient Sequence	03
ingredientName	Ingredient Name	sugar
ingredientSequence	Ingredient Sequence	04
ingredientName	Ingredient Name	corn flour
ingredientSequence	Ingredient Sequence	05
ingredientName	Ingredient Name	sodium bicarbonate
ingredientSequence	Ingredient Sequence	06
ingredientName	Ingredient Name	calcium carbonate
ingredientSequence	Ingredient Sequence	07
ingredientName	Ingredient Name	salt
ingredientSequence	Ingredient Sequence	08
ingredientName	Ingredient Name	caramel color
ingredientSequence	Ingredient Sequence	09
ingredientName	Ingredient Name	sodium ascorbate
ingredientSequence	Ingredient Sequence	10
ingredientName	Ingredient Name	reduced iron
ingredientSequence	Ingredient Sequence	11

Module/Class/Attribute Name	Attribute	Value <i>(description in italics)</i>
ingredientName	Ingredient Name	alpha tocopherol acetate
ingredientSequence	Ingredient Sequence	12
ingredientName	Ingredient Name	BHT
ingredientPurpose	Ingredient Purpose	PRESERVATIVE
ingredientSequence	Ingredient Sequence	13
ingredientName	Ingredient Name	niacinamide
ingredientPurpose	Ingredient Purpose	vitamin B3
ingredientSequence	Ingredient Sequence	14
ingredientName	Ingredient Name	zinc oxide
ingredientSequence	Ingredient Sequence	15
ingredientName	Ingredient Name	thiamine mononitrate
ingredientPurpose	Ingredient Purpose	vitamin B1
ingredientSequence	Ingredient Sequence	16
ingredientName	Ingredient Name	folic acid
ingredientSequence	Ingredient Sequence	17
ingredientName	Ingredient Name	pyridoxine hydrochloride
ingredientPurpose	Ingredient Purpose	vitamin B6
ingredientSequence	Ingredient Sequence	18
ingredientName	Ingredient Name	vitamin A palmitate
ingredientSequence	Ingredient Sequence	19
ingredientName	Ingredient Name	riboflavin
ingredientPurpose	Ingredient Purpose	vitamin B2

32.7 Example 4: Brand, Sub Brand, Variant

This example illustrates how information given on the label actually translates into master data in GDS. It reflects a label that meets the regulatory requirements of EU 1169. This information could vary depending on your regulatory requirements of the target market.



Module/Class/Attribute Name	Attribute	Value <i>(description in italics)</i>
brandName	Brand Name	First-Class
subBrand	Sub Brand	Génial
variant	Variant	Pepper
Trade Item Variant Class		
tradeItemVariantTypeCode	Trade Item Variant Type Code	FLAVOUR
tradeItemVariantValue	Trade Item Variant Value	Pepper

32.8 Example 5: Ingredients and allergens

This example illustrates how information given on the label actually translates into master data in GDS.

Ingredients: Water, vegetable oils (soya, corn), modified starch, CREAM, tomato, spices (green peppercorns (1.3%), black pepper (0.3%), white pepper (<0.1%)), salt, flavourings, cognac, caramel syrup, natural flavourings (natural CELERY flavouring, natural pepper flavouring), emulsifier (E472e), yeast extract, shallots, thickener (xanthan gum), colour (E150c).
 May contain gluten and egg.

Attribute Name	User Friendly Name	Value <i>(Code description italicized)</i>
Module: AllergenInformationModule		
allergenSpecificationAgency	Allergen Specification Agency	EU
allergenSpecificationName	Allergen Specification Name	1169/2011
allergenStatement	Allergen Statement	Contains: Milk; Celery; May Contains: Cereals, Eggs
allergenRelevantDataProvided	Is all allergen data provided	TRUE
Allergen Class		
allergenTypeCode	Allergen Type Code	AE: <i>Egg and their derivatives</i>
levelOfContainmentCode	Level of Containment	May Contain
allergenTypeCode	Allergen Type Code	AM: <i>Milk and it's derivatives</i>
levelOfContainmentCode	Level of Containment	Contains
allergenTypeCode	Allergen Type Code	AW: <i>Cereals containing gluten and their derivatives</i>
levelOfContainmentCode	Level of Containment	May Contain
allergenTypeCode	Allergen Type Code	BC: <i>Celery and their derivatives</i>
levelOfContainmentCode	Level of Containment	Contains
allergenTypeCode	Allergen Type Code	UW: <i>Wheat and it's derivatives</i>
levelOfContainmentCode	Level of Containment	May Contain
Module: FoodAndBeverageIngredientModule		
ingredientStatement	Ingredient Statement	Water; vegetable oils (soya; corn); modified starch; CREAM; tomato; spices (green peppercorns (1.3%); black pepper (0.3%); white pepper (<0.1%)); salt; flavourings; cognac; caramel syrup; natural flavourings (natural CELERY flavouring; natural pepper flavouring); emulsifier (E472e); yeast extract; shallots; thickener

Attribute Name	User Friendly Name	Value <i>(Code description italicized)</i>
		(xanthan gum); colour (E150c). May contain gluten and egg.
ingredientSequence	Sequence number of ingredient	01
ingredientName	Ingredient Name	WATER
ingredientSequence	Sequence number of ingredient	02
ingredientName	Ingredient Name	VEGETABLE OILS
ingredientSequence	Sequence number of sub ingredient of 1 st level	02.01
ingredientName	Ingredient Name	SOYA
ingredientSequence	Sequence number of sub ingredient of 1 st level	02.02
ingredientName	Ingredient Name	CORN
ingredientSequence	Sequence number of ingredient	03
ingredientName	Ingredient Name	MODIFIED STARCH
ingredientSequence	Sequence number of ingredient	04
ingredientName	Ingredient Name	CREAM
ingredientSequence	Sequence number of ingredient	05
ingredientName	Ingredient Name	TOMATO
ingredientSequence	Sequence number of ingredient	06
ingredientName	Ingredient Name	SPICES
ingredientSequence	Sequence number of sub ingredient of 1 st level	06.01
ingredientName	Ingredient Name	GREEN PEPPERCORNS (1.3%)
ingredientSequence	Sequence number of sub ingredient of 1 st level	06.02
ingredientName	Ingredient Name	BLACK PEPPER (0.3%)
ingredientSequence	Sequence number of sub ingredient of 1 st level	06.03
ingredientName	Ingredient Name	WHITE PEPPER (<0.1%)
ingredientSequence	Sequence number of ingredient	07
ingredientName	Ingredient Name	SALT
ingredientSequence	Sequence number of ingredient	08
ingredientName	Ingredient Name	FLAVOURINGS
ingredientSequence	Sequence number of ingredient	09
ingredientName	Ingredient Name	COGNAC
ingredientSequence	Sequence number of ingredient	10
ingredientName	Ingredient Name	CARAMEL SYRUP
ingredientSequence	Sequence number of ingredient	11
ingredientName	Ingredient Name	NATURAL FLAVOURINGS
ingredientSequence	Sequence number of sub ingredient of 1 st level	11.01
ingredientName	Ingredient Name	NATURAL CELERY FLAVOURING

Attribute Name	User Friendly Name	Value <i>(Code description italicized)</i>
ingredientSequence	Sequence number of sub ingredient of 1 st level	11.02
ingredientName	Ingredient Name	NATURAL PEPPER FLAVOURING
ingredientSequence	Sequence number of ingredient	12
ingredientName	Ingredient Name	EMULSIFIER (E472E)
ingredientSequence	Sequence number of ingredient	13
ingredientName	Ingredient Name	YEAST EXTRACT
ingredientSequence	Sequence number of ingredient	14
ingredientName	Ingredient Name	SHALLOTS
ingredientSequence	Sequence number of ingredient	15
ingredientName	Ingredient Name	THICKENER
ingredientSequence	Sequence number of sub ingredient of 1 st level	15.01
ingredientName	Ingredient Name	XANTHAN GUM
ingredientSequence	Sequence number of ingredient	16
ingredientName	Ingredient Name	COLOUR (E150C)

32.9 Example 6: Nutrients, preparation state, regulated product name, nutritional claim

This example illustrates how information given on the label actually translates into master data in GDS.

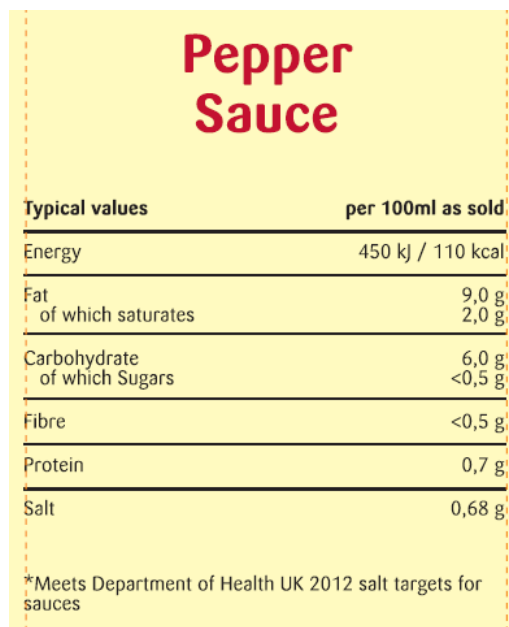

Pepper Sauce

Typical values	per 100ml as sold
Energy	450 kJ / 110 kcal
Fat	9,0 g
of which saturates	2,0 g
Carbohydrate	6,0 g
of which Sugars	<0,5 g
Fibre	<0,5 g
Protein	0,7 g
Salt	0,68 g

*Meets Department of Health UK 2012 salt targets for sauces

Attribute Name	User Friendly Name	Value <i>(description in italics)</i>
Module: TradeItemDescriptionModule		
regulatedProductName	Regulated Product Name	Pepper Sauce
Module: FoodAndBeveragePreparationServingModule		
numberOfServingsPerPackage	Number of Servings per Package	<i>Populate Value As Appropriate</i>
numberOfServingsPerPackage MeasurementPrecisionCode	Measurement Precision Code for Number of Servings per Package	<i>Populate Value As Appropriate</i>
Module: NutritionalInformationModule		
Food Beverage Composition Class		
foodBeverageComposition DatabaseCode	Nutrient Database (used when no NLEA panel but a USDA NDB#)	<i>Populate Value As Appropriate</i>
foodBeverageCompositionCode	Code Value from Composition Database	<i>Populate Value As Appropriate</i>
foodBeverageComposition Description	Description of the code from Composition Database	<i>Populate Value As Appropriate</i>
Nutritional Claim		
nutritionalClaim	Nutritional Claim	Meets Department of Health UK 2012
Nutrient Header Class		
dailyValueIntakeReference	Daily Value Intake Reference	<i>Populate Value As Appropriate</i>
preparationStateCode	Preparation State	<i>UNPREPARED</i>
nutrientBasisQuantity TypeCode	Nutrient Basis Quantity Type Code	<i>BY_MEASURE</i>
nutrientBasisQuantity	Nutrient Basis Quantity	<i>100 MLT</i>
servingSizeDescription	Serving Size Description (formerly Household Serving Size)	Per 100ml as sold
servingSize	Serving Size	<i>Populate Value As Appropriate</i>
servingSizeGramWeight	Serving Size in Grams	<i>Populate Value As Appropriate</i>
nutrientRelevantDataProvided	Is all nutrient data provided	TRUE
nutrientValueDerivation	How the nutrient data is gathered	<i>Populate Value As Appropriate</i>
Nutrient Detail Class		
nutrientTypeCode	Nutrient Type Code	ENER-: <i>Calories</i>
measurementPrecisionCode	Measurement Precision	Approximately
quantityContained	Nutrient Quantity and Unit of Measure	450 KJ: <i>KiloJoule</i>
nutrientTypeCode	Nutrient Type Code	ENER-: <i>Calories</i>
measurementPrecisionCode	Measurement Precision	Approximately
quantityContained	Nutrient Quantity and Unit of Measure	110 E14: <i>Kilocalorie / Calorie*</i>
nutrientTypeCode	Nutrient Type Code	FAT: <i>Total Fat</i>
measurementPrecisionCode	Measurement Precision	Approximately
quantityContained	Nutrient Quantity and Unit of Measure	9 GRM
nutrientTypeCode	Nutrient Type Code	FASAT: <i>Saturated Fat</i>
measurementPrecisionCode	Measurement Precision	Approximately
quantityContained	Nutrient Quantity and Unit of Measure	2 GRM
nutrientTypeCode	Nutrient Type Code	CHOAVL: <i>Carbohydrate</i>

Attribute Name	User Friendly Name	Value <i>(description in italics)</i>
measurementPrecisionCode	Measurement Precision	Approximately
quantityContained	Nutrient Quantity and Unit of Measure	6 GRM
nutrientTypeCode	Nutrient Type Code	SUGAR-: <i>Carbohydrate of which sugars</i>
measurementPrecisionCode	Measurement Precision	Approximately
quantityContained	Nutrient Quantity and Unit of Measure	0.4 GRM
nutrientTypeCode	Nutrient Type Code	FIBTG: <i>Fibre</i>
measurementPrecisionCode	Measurement Precision	Approximately
quantityContained	Nutrient Quantity and Unit of Measure	0.3 GRM
nutrientTypeCode	Nutrient Type Code	PRO-: <i>Protein</i>
measurementPrecisionCode	Measurement Precision	Approximately
quantityContained	Nutrient Quantity and Unit of Measure	0.7 GRM
nutrientTypeCode	Nutrient Type Code	SALTEQ: <i>Salt Equivalent</i>
measurementPrecisionCode	Measurement Precision	Approximately
quantityContained	Nutrient Quantity and Unit of Measure	0.68 GRM

32.10 Example 7: Net content, package marks environment

This example illustrates how information given on the label actually translates into master data in GDS. The information on the logo is translated into the **packageMarksEnvironment** attribute.

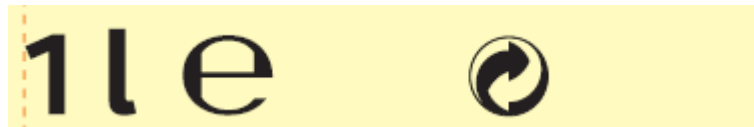

Module: TradeItemMeasurementsModule		
netContent/UOM	Declared Net Content	1000 Millilitre
Module: PackagingMarkingModule		
packagingMarkedLabelAccreditationCode	Packaging Marked Label Accreditation Code	GREEN_DOT

32.11 Example 8: Address and Contact Information

This example illustrates how information given on the label actually translates into master data in GDS.



Contact Information

Attribute Name	User Friendly Name	Value
Module: TradeItem		
GLN	GLN of Contact Information Provider	xxxxxxxxxxxxx
contactAddress	Contact Address	Maritime Food Solutions 1 Maritime Rd, London SW5B UK
contactTypeCode	Type of Contact <i>CXC = code for CONSUMER_SUPPORT</i>	CXC
availableTime	Time Contact is Available	7:00 AM-9:00 PM
communicationChannelCode	Type of Communication Channel	TELEPHONE
communicationChannel Number	Phone Number	xxx-xxx-xxxx

32.12 Example 9: Marketing Message and Storage Instructions

This example illustrates how information given on the label actually translates into master data in GDS. It is not part of the Food Panel.

Génial Pepper Sauce
 A delicious and versatile ready to use Sauce.
 Excellent on its own or enhanced by your own Creative touch. Génial Sauces complement meat, poultry, fish, and vegetable dishes. Suitable for use on hob, in the microwave, or bain-marie.
 No added MSG.

Store in a cool dry place.
 Once opened, keep refrigerated and use within 2 days.

Attribute Name	User Friendly Name	Value
Module: MarketingInformationModule		
tradeItemMarketingMessage	Marketing Message - Benefits	Génial Pepper Sauce a delicious and versatile ready to use sauce. Excellent on its own or enhanced by your own creative touch. Génial Sauces complement meat, poultry, fish and vegetable dishes. Suitable for use on the hob, in the microwave or bain-marie. No added MSG.
Module: ConsumerInstructionsModule		
consumerStorageInstructions	Consumer Storage Instructions	Store in a cool dry place. Once opened, keep refrigerated and use within 2 days.

32.13 Example 10: Consumer Pack with Unmarked Multiple Components

- **Note:** This example illustrates how information given on the label actually translates into master data in GDS.



Attribute Name	User Friendly Name	Value
Module: TradeItemDescriptionModule		
brandName	Brand Name	Sun Valley
functionalName	Functional Name	Granola Bars
variantDescription	Variant	Variety Pack
Trade Item Variant Class		
tradeItemVariantTypeCode	Trade Item Variant Type Code	FLAVOUR
tradeItemVariantValue	Trade Item Variant Value	Maple Brown Sugar
tradeItemVariantTypeCode	Trade Item Variant Type Code	FLAVOUR
tradeItemVariantValue	Trade Item Variant Value	Peanut Butter
tradeItemVariantTypeCode	Trade Item Variant Type Code	FLAVOUR
tradeItemVariantValue	Trade Item Variant Value	Oats 'n Honey

*16g of whole grain per serving. At least 48g recommended daily.

Nutrition Facts

Serving Size 2 bars (42g)
Servings Per Container 12

Amount Per Serving	Maple Brown Sugar	Peanut Butter	Oats 'n Honey
Calories	190	190	190
Calories from Fat	60	80	60
	% DV*	% DV*	% DV*
Total Fat	7g 11%	8g 13%	7g 11%
Saturated Fat	1g 4%	1g 5%	1g 4%
Trans Fat	0g	0g	0g
Cholesterol	0mg 0%	0mg 0%	0mg 0%
Sodium	170mg 7%	180mg 8%	180mg 7%
Total Carbohydrate	29g 10%	27g 9%	29g 10%
Dietary Fiber	2g 9%	2g 9%	2g 9%
Sugars	12g	11g	11g
Protein	3g	4g	3g
Iron	4%	4%	4%

Not a significant source of vitamin A, vitamin C and calcium.
*Percent Daily Values (DV) are based on a 2,000 calorie diet. Your daily values may be higher or lower depending on your calorie needs:

	Calories	2,000	2,500
Total Fat	Less than	65g	80g
Sat Fat	Less than	20g	25g
Cholesterol	Less than	300mg	300mg
Sodium	Less than	2,400mg	2,400mg
Total Carbohydrate		300g	375g
Dietary Fiber		25g	30g

Maple Brown Sugar Ingredients: Whole Grain Oats, Sugar, Canola Oil, Rice Flour, Brown Sugar Syrup, Maple Syrup, Salt, Soy Lecithin, Baking Soda, Natural Flavor.
CONTAINS SOY; MAY CONTAIN PEANUT, ALMOND AND PECAN INGREDIENTS.

Peanut Butter Ingredients: Whole Grain Oats, Sugar, Canola Oil, Peanut Butter (peanuts, salt), Rice Flour, Brown Sugar Syrup, Salt, Baking Soda, Soy Lecithin.
CONTAINS PEANUT, SOY; MAY CONTAIN ALMOND AND PECAN INGREDIENTS.

Oats 'n Honey Ingredients: Whole Grain Oats, Sugar, Canola Oil, Rice Flour, Honey, Salt, Brown Sugar Syrup, Baking Soda, Soy Lecithin, Natural Flavor.
CONTAINS SOY; MAY CONTAIN PEANUT, ALMOND AND PECAN INGREDIENTS.

DISTRIBUTED BY GENERAL MILLS SALES, INC., MINNEAPOLIS, MN 55440 USA

Attribute Name	User Friendly Name	Value (Code description italicized)
TradeItem		
TradeItemComponents		
totalNumberOfComponents	Number of Components in Trade Item	3
Component Information		
componentNumber	Component Number	1
Module: FoodAndBeveragePreparationServingModule		
numberOfServingsPerPackage	Number of Servings per Package	12
numberOfServingsPerPackage MeasurementPrecisionCode	Measurement Precision Code for Number of Servings per Package	EXACTLY

Module: AllergenInformationModule		
allergenSpecificationAgency	Allergen Specification Agency	FDA
allergenSpecificationName	Allergen Specification Name	Food Allergen Labelling and Consumer Protection Act of 2004
allergenStatement	Allergen Statement	CONTAINS SOY; MAY CONTAIN PEANUT, ALMOND AND PECAN INGREDIENTS.
allergenRelevantDataProvided	Is all allergen data provided	TRUE
allergenTypeCode	Allergen Type Code	AY: <i>Soybeans and their derivatives</i>
levelOfContainmentCode	Level of Containment	CONTAINS
allergenTypeCode	Allergen Type Code	AP: <i>Peanuts and their derivatives</i>
levelOfContainmentCode	Level of Containment	MAY CONTAIN
allergenTypeCode	Allergen Type Code	SA: <i>Almond and almond products</i>
levelOfContainmentCode	Level of Containment	MAY CONTAIN
allergenTypeCode	Allergen Type Code	SP: <i>Pecan nut and pecan nut products</i>
levelOfContainmentCode	Level of Containment	MAY CONTAIN
Module: FoodAndBeverageIngredientModule		
ingredientStatement	Ingredient Statement	Maple Brown Sugar Ingredients: Whole Grain Oats, Sugar, Canola Oil, Rice Flour, Brown Sugar Syrup, Maple Syrup, Salt, Soy Lecithin, Baking Soda, Natural Flavor
ingredientSequence	Sequence number of ingredient	01
ingredientName	Ingredient Name	Whole Grain Oats
ingredientSequence	Sequence number of ingredient	02
ingredientName	Ingredient Name	Sugar
ingredientSequence	Sequence number of ingredient	03
ingredientName	Ingredient Name	Canola Oil
ingredientSequence	Sequence number of ingredient	04
ingredientName	Ingredient Name	Rice Flour
ingredientSequence	Sequence number of ingredient	05
ingredientName	Ingredient Name	Brown Sugar Syrup
ingredientSequence	Sequence number of ingredient	06
ingredientName	Ingredient Name	Maple Syrup
ingredientSequence	Sequence number of ingredient	07
ingredientName	Ingredient Name	Salt
ingredientSequence	Sequence number of ingredient	08
ingredientName	Ingredient Name	Soy Lecithin
ingredientSequence	Sequence number of ingredient	09
ingredientName	Ingredient Name	Baking Soda
ingredientSequence	Sequence number of ingredient	10
ingredientName	Ingredient Name	Natural Flavor



Module: NutritionalInformationModule		
Food Beverage Composition Class		
foodBeverageComposition DatabaseCode	Nutrient Database (used when no NLEA panel but a USDA NDB#)	USDA
foodBeverageCompositionCode	Code Value from Composition Database	08277
foodBeverageComposition Description	Description of the code from Composition Database	Cereals ready to eat Sun Valley Crunchy Granola
Nutrient Header Class		
dailyValueIntakeReference	Daily Value Intake Reference	Percent Daily Values are based on a 2,000 calorie diet.
preparationStateCode	Preparation State	PREPARED
nutrientBasisQuantity TypeCode	Nutrient Basis Quantity Type Code	BY_SERVING
nutrientBasisQuantity	<i>EA = Code for Each</i>	EA
servingSizeDescription	Serving Size Description (formerly Household Serving Size)	2 bars
servingSize	Serving Size	1 EA
servingSizeGramWeight	Serving Size in Grams	42 GRM
nutrientRelevantDataProvided	Is all nutrient data provided	TRUE
nutrientValueDerivation	How the nutrient data is gathered	ANALYTICAL_AND_CALCULATED
Nutrient Detail Class		
nutrientTypeCode	Nutrient Type Code	ENER-: <i>Calories</i>
measurementPrecisionCode	Measurement Precision	Approximately
quantityContained	Nutrient Quantity and Unit of Measure	190 E14 Kilocalorie / Calorie*
nutrientTypeCode	Nutrient Type Code	ENERPF: <i>Calories from Fat</i>
measurementPrecisionCode	Measurement Precision	Approximately
quantityContained	Nutrient Quantity and Unit of Measure	60 E14 Kilocalorie / Calorie*
nutrientTypeCode	Nutrient Type Code	FATNLEA: <i>Total Fat</i>
measurementPrecisionCode	Measurement Precision	Approximately
quantityContained	Nutrient Quantity and Unit of Measure	7 GRM
dailyValueIntakePercent MeasurementPrecisionCode	Daily Value Intake Percent Measurement Precision	Approximately
dailyValueIntakePercent	Daily Value Intake Percent	11
nutrientTypeCode	Nutrient Type Code	FASAT: <i>Saturated Fat</i>
measurementPrecisionCode	Measurement Precision	Approximately
quantityContained	Nutrient Quantity and Unit of Measure	1 GRM
dailyValueIntakePercent MeasurementPrecisionCode	Daily Value Intake Percent Measurement Precision	Approximately
dailyValueIntakePercent	Daily Value Intake Percent	4
nutrientTypeCode	Nutrient Type Code	FATRNR: <i>Trans Fat</i>
measurementPrecisionCode	Measurement Precision	Approximately
quantityContained	Nutrient Quantity and Unit of Measure	0 GRM



nutrientTypeCode	Nutrient Type Code	CHOL: <i>Cholesterol</i>
measurementPrecisionCode	Measurement Precision	Approximately
quantityContained	Nutrient Quantity and Unit of Measure	0 MGM
dailyValueIntakePercent MeasurementPrecisionCode	Daily Value Intake Percent Measurement Precision	Approximately
dailyValueIntakePercent	Daily Value Intake Percent	0
nutrientTypeCode	Nutrient Type Code	NA: <i>Sodium</i>
measurementPrecisionCode	Measurement Precision	Approximately
quantityContained	Nutrient Quantity and Unit of Measure	170 MGM
dailyValueIntakePercent MeasurementPrecisionCode	Daily Value Intake Percent Measurement Precision	Approximately
dailyValueIntakePercent	Daily Value Intake Percent	7
nutrientTypeCode	Nutrient Type Code	CHO-: <i>Total Carbohydrate</i>
measurementPrecisionCode	Measurement Precision	Approximately
quantityContained	Nutrient Quantity and Unit of Measure	29 GRM
dailyValueIntakePercent MeasurementPrecisionCode	Daily Value Intake Percent Measurement Precision	Approximately
dailyValueIntakePercent	Daily Value Intake Percent	10
nutrientTypeCode	Nutrient Type Code	FIBTSW: <i>Dietary Fiber</i>
measurementPrecisionCode	Measurement Precision	Approximately
quantityContained	Nutrient Quantity and Unit of Measure	3 GRM
dailyValueIntakePercent MeasurementPrecisionCode	Daily Value Intake Percent Measurement Precision	Approximately
dailyValueIntakePercent	Daily Value Intake Percent	9
nutrientTypeCode	Nutrient Type Code	SUGAR: <i>Sugars</i>
measurementPrecisionCode	Measurement Precision	Approximately
quantityContained	Nutrient Quantity and Unit of Measure	12 GRM
nutrientTypeCode	Nutrient Type Code	PRO-: <i>Protein</i>
measurementPrecisionCode	Measurement Precision	Approximately
quantityContained	Nutrient Quantity and Unit of Measure	3 GRM
nutrientTypeCode	Nutrient Type Code	FE: <i>Iron</i>
dailyValueIntakePercent MeasurementPrecisionCode	Daily Value Intake Percent Measurement Precision	Approximately
dailyValueIntakePercent	Daily Value Intake Percent	4

Attribute Name	User Friendly Name	Value (Code description italicized)
Component Information		
componentNumber	Component Number	2
Module: AllergenInformationModule		
allergenSpecificationAgency	Allergen Specification Agency	FDA
allergenSpecificationName	Allergen Specification Name	<i>Populate Value As Appropriate</i>



Attribute Name	User Friendly Name	Value <i>(Code description italicized)</i>
allergenStatement	Allergen Statement	CONTAINS PEANUT, SOY; MAY CONTAIN ALMOND AND PECAN INGREDIENTS
allergenRelevantDataProvided	Is all allergen data provided	TRUE
allergenTypeCode	Allergen Type Code	AY: <i>Soybeans and their derivatives</i>
levelOfContainmentCode	Level of Containment	CONTAINS
allergenTypeCode	Allergen Type Code	AP: <i>Peanuts and their derivatives</i>
levelOfContainmentCode	Level of Containment	CONTAINS
allergenTypeCode	Allergen Type Code	SA: <i>Almond and almond products</i>
levelOfContainmentCode	Level of Containment	MAY CONTAIN
allergenTypeCode	Allergen Type Code	SP: <i>Pecan nut and pecan nut products</i>
levelOfContainmentCode	Level of Containment	MAY CONTAIN
Module: FoodAndBeverageIngredientModule		
ingredientStatement	Ingredient Statement	Peanut Butter Ingredients: Whole Grain Oats, Sugar, Canola Oil, Peanut Butter (peanuts, salt), Rice Flour, Brown Sugar Syrup, Salt, Baking Soda, Soy Lecithin
ingredientSequence	Sequence number of ingredient	01
ingredientName	Ingredient Name	Whole Grain Oats
ingredientSequence	Sequence number of ingredient	02
ingredientName	Ingredient Name	Sugar
ingredientSequence	Sequence number of ingredient	03
ingredientName	Ingredient Name	Canola Oil
ingredientSequence	Sequence number of ingredient	04
ingredientName	Ingredient Name	Peanut Butter
ingredientSequence	Sequence number of sub ingredient of 4th level	04.01
ingredientName	Ingredient Name	Peanuts
ingredientSequence	Sequence number of sub ingredient of 4th level	04.02
ingredientName	Ingredient Name	Salt
ingredientSequence	Sequence number of ingredient	05
ingredientName	Ingredient Name	Rice Flour
ingredientSequence	Sequence number of ingredient	06
ingredientName	Ingredient Name	Brown Sugar Syrup
ingredientSequence	Sequence number of ingredient	07
ingredientName	Ingredient Name	Salt
ingredientSequence	Sequence number of ingredient	08
ingredientName	Ingredient Name	Baking Soda
ingredientSequence	Sequence number of ingredient	09
ingredientName	Ingredient Name	Soy Lecithin



Attribute Name	User Friendly Name	Value
Module: NutritionalInformationModule		
Food Beverage Composition Class		
foodBeverageComposition DatabaseCode	Nutrient Database (used when no NLEA panel but a USDA NDB#)	Populate Value As Appropriate
foodBeverageCompositionCode	Code Value from Composition Database	Populate Value As Appropriate
foodBeverageComposition Description	Description of the Code from Composition Database	Populate Value As Appropriate
Nutrient Header Class		
dailyValueIntakeReference	Daily Value Intake Reference	Percent Daily Values are based on a 2,000 calorie diet.
preparationStateCode	Preparation State	PREPARED
nutrientBasisQuantity TypeCode	Nutrient Basis Quantity Type Code	BY_SERVING
nutrientBasisQuantity	<i>EA = Code for Each</i>	EA
servingSizeDescription	Serving Size Description (formerly Household Serving Size)	2 bars
servingSize	Serving Size	1 EA
servingSizeGramWeight	Serving Size in Grams	42 GRM
nutrientRelevantDataProvided	Is all nutrient data provided	TRUE
nutrientValueDerivation	How the nutrient data is gathered	ANALYTICAL_AND_CALCULATED
Nutrient Detail Class		
nutrientTypeCode	Nutrient Type Code	ENER-: <i>Calories</i>
measurementPrecisionCode	Measurement Precision	Approximately
quantityContained	Nutrient Quantity and Unit of Measure	190 E14 Kilocalorie / Calorie*
nutrientTypeCode	Nutrient Type Code	ENERPF: <i>Calories from Fat</i>
measurementPrecisionCode	Measurement Precision	Approximately
quantityContained	Nutrient Quantity and Unit of Measure	80 E14 Kilocalorie / Calorie*
nutrientTypeCode	Nutrient Type Code	FATNLEA: <i>Total Fat</i>
measurementPrecisionCode	Measurement Precision	Approximately
quantityContained	Nutrient Quantity and Unit of Measure	8 GRM
dailyValueIntakePercent MeasurementPrecisionCode	Daily Value Intake Percent Measurement Precision	Approximately
dailyValueIntakePercent	Daily Value Intake Percent	13
nutrientTypeCode	Nutrient Type Code	FASAT: <i>Saturated Fat</i>
measurementPrecisionCode	Measurement Precision	Approximately
quantityContained	Nutrient Quantity and Unit of Measure	1 GRM
dailyValueIntakePercent MeasurementPrecisionCode	Daily Value Intake Percent Measurement Precision	Approximately



dailyValueIntakePercent	Daily Value Intake Percent	5
nutrientTypeCode	Nutrient Type Code	FATR: <i>Trans Fat</i>
measurementPrecisionCode	Measurement Precision	Approximately
quantityContained	Nutrient Quantity and Unit of Measure	0 GRM
nutrientTypeCode	Nutrient Type Code	CHOL: <i>Cholesterol</i>
measurementPrecisionCode	Measurement Precision	Approximately
quantityContained	Nutrient Quantity and Unit of Measure	0 MGM
dailyValueIntakePercent MeasurementPrecisionCode	Daily Value Intake Percent Measurement Precision	Approximately
dailyValueIntakePercent	Daily Value Intake Percent	0
nutrientTypeCode	Nutrient Type Code	NA: <i>Sodium</i>
measurementPrecisionCode	Measurement Precision	Approximately
quantityContained	Nutrient Quantity and Unit of Measure	180 MGM
dailyValueIntakePercent MeasurementPrecisionCode	Daily Value Intake Percent Measurement Precision	Approximately
dailyValueIntakePercent	Daily Value Intake Percent	8
nutrientTypeCode	Nutrient Type Code	CHO-: <i>Total Carbohydrate</i>
measurementPrecisionCode	Measurement Precision	Approximately
quantityContained	Nutrient Quantity and Unit of Measure	27 GRM
dailyValueIntakePercent MeasurementPrecisionCode	Daily Value Intake Percent Measurement Precision	Approximately
dailyValueIntakePercent	Daily Value Intake Percent	9
nutrientTypeCode	Nutrient Type Code	FIBTSW: <i>Dietary Fiber</i>
measurementPrecisionCode	Measurement Precision	Approximately
quantityContained	Nutrient Quantity and Unit of Measure	2 GRM
dailyValueIntakePercent MeasurementPrecisionCode	Daily Value Intake Percent Measurement Precision	Approximately
dailyValueIntakePercent	Daily Value Intake Percent	9
nutrientTypeCode	Nutrient Type Code	SUGAR: <i>Sugars</i>
measurementPrecisionCode	Measurement Precision	Approximately
quantityContained	Nutrient Quantity and Unit of Measure	11 GRM
nutrientTypeCode	Nutrient Type Code	PRO-: <i>Protein</i>
measurementPrecisionCode	Measurement Precision	Approximately
quantityContained	Nutrient Quantity and Unit of Measure	4 GRM
nutrientTypeCode	Nutrient Type Code	FE: <i>Iron</i>
dailyValueIntakePercent MeasurementPrecisionCode	Daily Value Intake Percent Measurement Precision	Approximately
dailyValueIntakePercent	Daily Value Intake Percent	4

Attribute Name	User Friendly Name	Value <i>(Code description italicized)</i>
Component Information		
componentNumber	Component Number	3
Module: AllergenInformationModule		
allergenSpecificationAgency	Allergen Specification Agency	FDA
allergenSpecificationName	Allergen Specification Name	Populate Value As Appropriate
allergenStatement	Allergen Statement	CONTAINS SOY; MAY CONTAIN PEANUT, ALMOND AND PECAN INGREDIENTS.
allergenRelevantDataProvided	Is all allergen data provided	TRUE
allergenTypeCode	Allergen Type Code	AY: <i>Soybeans and their derivatives</i>
levelOfContainmentCode	Level of Containment	CONTAINS
allergenTypeCode	Allergen Type Code	AP: <i>Peanuts and their derivatives</i>
levelOfContainmentCode	Level of Containment	MAY CONTAIN
allergenTypeCode	Allergen Type Code	SA: <i>Almond and almond products</i>
levelOfContainmentCode	Level of Containment	MAY CONTAIN
allergenTypeCode	Allergen Type Code	SP: <i>Pecan nut and pecan nut products</i>
levelOfContainmentCode	Level of Containment	MAY CONTAIN
Module: FoodAndBeverageIngredientModule		
ingredientStatement	Ingredient Statement	Oats `n Honey Ingredients: Whole Grain Oats, Sugar, Canola Oil, Rice Flour, Honey, Salt, Brown Sugar Syrup, Baking Soda, Soy Lecithin, Natural Flavor.
ingredientSequence	Sequence number of ingredient	01
ingredientName	Ingredient Name	Whole Grain Oats
ingredientSequence	Sequence number of ingredient	02
ingredientName	Ingredient Name	Sugar
ingredientSequence	Sequence number of ingredient	03
ingredientName	Ingredient Name	Canola Oil
ingredientSequence	Sequence number of ingredient	04
ingredientName	Ingredient Name	Rice Flour
ingredientSequence	Sequence number of ingredient	05
ingredientName	Ingredient Name	Honey
ingredientSequence	Sequence number of ingredient	06
ingredientName	Ingredient Name	Salt
ingredientSequence	Sequence number of ingredient	07
ingredientName	Ingredient Name	Brown Sugar Syrup
ingredientSequence	Sequence number of ingredient	08
ingredientName	Ingredient Name	Baking Soda
ingredientSequence	Sequence number of ingredient	09
ingredientName	Ingredient Name	Soy Lecithin



Attribute Name	User Friendly Name	Value <i>(Code description italicized)</i>
ingredientSequence	Sequence number of ingredient	10
ingredientName	Ingredient Name	Natural Flavor
Module: NutritionalInformationModule		
Food Beverage Composition Class		
foodBeverageCompositionDatabaseCode	Nutrient Database (used when no NLEA panel but a USDA NDB#)	Populate Value As Appropriate
foodBeverageCompositionCode	Code Value from Composition Database	Populate Value As Appropriate
foodBeverageCompositionDescription	Description of the code from Composition Database	Populate Value As Appropriate
Nutrient Header Class		
dailyValueIntakeReference	Daily Value Intake Reference	Percent Daily Values are based on a 2,000 calorie diet.
preparationStateCode	Preparation State	PREPARED
nutrientBasisQuantityTypeCode	Nutrient Basis Quantity Type Code	BY_SERVING
nutrientBasisQuantity	<i>EA = Code for Each</i>	EA
servingSizeDescription	Serving Size Description (formerly Household Serving Size)	2 bars
servingSize	Serving Size	1 EA
servingSizeGramWeight	Serving Size in Grams	42 GRM
nutrientRelevantDataProvided	Is all nutrient data provided	TRUE
nutrientValueDerivation	How the nutrient data is gathered	ANALYTICAL_AND_CALCULATED
Nutrient Detail Class		
nutrientTypeCode	Nutrient Type Code	ENER-: <i>Calories</i>
measurementPrecisionCode	Measurement Precision	Approximately
quantityContained	Nutrient Quantity and Unit of Measure	190 E14 Kilocalorie / Calorie*
nutrientTypeCode	Nutrient Type Code	ENERPF: <i>Calories from Fat</i>
measurementPrecisionCode	Measurement Precision	Approximately
quantityContained	Nutrient Quantity and Unit of Measure	60 E14 Kilocalorie / Calorie*
nutrientTypeCode	Nutrient Type Code	FATNLEA: <i>Total Fat</i>
measurementPrecisionCode	Measurement Precision	Approximately
quantityContained	Nutrient Quantity and Unit of Measure	7 GRM
dailyValueIntakePercentMeasurementPrecisionCode	Daily Value Intake Percent Measurement Precision	Approximately
dailyValueIntakePercent	Daily Value Intake Percent	11
nutrientTypeCode	Nutrient Type Code	FASAT: <i>Saturated Fat</i>
measurementPrecisionCode	Measurement Precision	Approximately
quantityContained	Nutrient Quantity and Unit of Measure	1 GRM
dailyValueIntakePercentMeasurementPrecisionCode	Daily Value Intake Percent Measurement Precision	Approximately
dailyValueIntakePercent	Daily Value Intake Percent	4
nutrientTypeCode	Nutrient Type Code	FATR: <i>Trans Fat</i>



measurementPrecisionCode	Measurement Precision	Approximately
quantityContained	Nutrient Quantity and Unit of Measure	0 GRM
nutrientTypeCode	Nutrient Type Code	CHOL: <i>Cholesterol</i>
measurementPrecisionCode	Measurement Precision	Approximately
quantityContained	Nutrient Quantity and Unit of Measure	0 MGM
dailyValueIntakePercent MeasurementPrecisionCode	Daily Value Intake Percent Measurement Precision	Approximately
dailyValueIntakePercent	Daily Value Intake Percent	0
nutrientTypeCode	Nutrient Type Code	NA: <i>Sodium</i>
measurementPrecisionCode	Measurement Precision	Approximately
quantityContained	Nutrient Quantity and Unit of Measure	180 MGM
dailyValueIntakePercent MeasurementPrecisionCode	Daily Value Intake Percent Measurement Precision	Approximately
dailyValueIntakePercent	Daily Value Intake Percent	7
nutrientTypeCode	Nutrient Type Code	CHO-: <i>Total Carbohydrate</i>
measurementPrecisionCode	Measurement Precision	Approximately
quantityContained	Nutrient Quantity and Unit of Measure	29 GRM
dailyValueIntakePercent MeasurementPrecisionCode	Daily Value Intake Percent Measurement Precision	Approximately
dailyValueIntakePercent	Daily Value Intake Percent	10
nutrientTypeCode	Nutrient Type Code	FIBTSW: <i>Dietary Fiber</i>
measurementPrecisionCode	Measurement Precision	Approximately
quantityContained	Nutrient Quantity and Unit of Measure	2 GRM
dailyValueIntakePercent MeasurementPrecisionCode	Daily Value Intake Percent Measurement Precision	Approximately
dailyValueIntakePercent	Daily Value Intake Percent	9
nutrientTypeCode	Nutrient Type Code	SUGAR: <i>Sugars</i>
measurementPrecisionCode	Measurement Precision	Approximately
quantityContained	Nutrient Quantity and Unit of Measure	11 GRM
nutrientTypeCode	Nutrient Type Code	PRO-: <i>Protein</i>
measurementPrecisionCode	Measurement Precision	Approximately
quantityContained	Nutrient Quantity and Unit of Measure	3 GRM
nutrientTypeCode	Nutrient Type Code	FE: <i>Iron</i>
dailyValueIntakePercent MeasurementPrecisionCode	Daily Value Intake Percent Measurement Precision	Approximately
dailyValueIntakePercent	Daily Value Intake Percent	4

For additional serving sizes (including 100 GRM), repeat these two Classes:

- Nutrient Header Class
- Nutrient Detail Class

32.14 Example 11: Nutrient Information

- Note:** Nutrient data for this listing was provided by USDA SR-21. Each "~" indicates a missing or incomplete value. "The Amino Acid Score has not been corrected for digestibility, which could reduce its value." This is the format that is used in Europe.

Nutritional information		
	Typical value per 100g provides;	Typical value per 8g biscuit provides;
Energy	1960kJ/467kcal	157kJ/37kcal
Fat	18.6g	1.5g
of which saturates	4.0g	0.3g
Carbohydrate	66.8g	5.3g
of which sugars	14.3g	1.1g
Fibre	4.6g	0.4g
Protein	5.8g	0.5g
Sodium	0.3g	0.02g
Salt	0.8g	0.06g
Thiamin	1.0mg	0.1mg

Contains naturally occurring sugars

32.15 Example 12: Brand, sub brand, functional name, variant

- **Note:** This example illustrates how information given on the label actually translates into master data in GDS.



Attribute Name	User Friendly Name	Value
Module: TradeItemDescriptionModule		
brandName	Brand Name	Great Breakfast
subBrand	Sub Brand	Scrambles
functionalName	Functional Name	Pizza
variant	Variant	Bacon Scramble

32.16 Example 13: Ingredients and allergens

- **Note:** This example illustrates how information given on the label actually translates into master data in GDS.

(CULTURED PASTEURIZED MILK, SALT, ENZYMES, ANNATTO [COLOR]), WATER, PALM OIL, YEAST, CONTAINS 2% OR LESS OF: VEGETABLE OIL (SOYBEAN AND/OR CANOLA OIL), MODIFIED FOOD STARCH, SALT, SUGAR, CREAM, BUTTER (CREAM, SALT), SPICE, WHEAT STARCH, DEFATTED SOY FLOUR, SOY LECITHIN, HICKORY SMOKE POWDER (MALTODEXTRIN POWDER, NATURAL HICKORY SMOKE FLAVOR), L-CYSTEINE HYDROCHLORIDE, AMMONIUM SULFATE, NATURAL FLAVOR, ASCORBIC ACID.
CONTAINS: WHEAT, MILK, EGG AND SOY.

INGREDIENTS: ENRICHED FLOUR (WHEAT FLOUR, MALTED BARLEY FLOUR, NIACIN, REDUCED IRON, THIAMINE MONONITRATE, RIBOFLAVIN, FOLIC ACID), NONFAT MILK, BACON WITH SMOKE FLAVORING ADDED (CURED WITH WATER, SALT, SUGAR, SMOKE FLAVORING, SODIUM PHOSPHATES, SODIUM ERYTHORBATE, SODIUM NITRITE), SCRAMBLED EGG (WHOLE EGGS, SKIM MILK, SOYBEAN OIL, CORN STARCH, SALT, XANTHAN GUM, CITRIC ACID), LOW MOISTURE PART SKIM MOZZARELLA CHEESE (CULTURED PASTEURIZED PART SKIM MILK, SALT, ENZYMES), CHEDDAR CHEESE

Attribute Name	User Friendly Name	Value <i>(Code description italicized)</i>
Module: AllergenInformationModule		
allergenSpecificationAgency	Allergen Specification Agency	FDA
allergenSpecificationName	Allergen Specification Name	21 USC 343
allergenStatement	Allergen Statement	Contains: Wheat, Milk, Egg and Soy
allergenRelevantDataProvided	Is all allergen data provided	TRUE
Allergen Class		
allergenTypeCode	Allergen Type Code	UW: <i>Wheat and it's derivatives</i>
levelOfContainmentCode	Level of Containment	Contains
allergenTypeCode	Allergen Type Code	AM: <i>Milk and it's derivatives</i>
levelOfContainmentCode	Level of Containment	Contains
allergenTypeCode	Allergen Type Code	AE: <i>Egg and their derivatives</i>
levelOfContainmentCode	Level of Containment	Contains
allergenTypeCode	Allergen Type Code	AY: <i>Soybeans and their derivatives</i>
levelOfContainmentCode	Level of Containment	Contains
Module: FoodAndBeverageIngredientModule		
ingredientStatement	Ingredient Statement	INGREDIENTS: ENRICHED FLOUR (WHEAT FLOUR, MALTED BARLEY FLOUR, NIACIN, REDUCED IRON, THIAMINE MONONITRATE, RIBOFLAVIN, FOLIC ACID), NONFAT MILK, BACON WITH SMOKE FLAVORING ADDED (CURED WITH WATER, SALT, SUGAR, SMOKE FLAVORING, SODIUM PHOSPHATES, SODIUM ERYTHORBATE, SODIUM NITRITE), SCRAMBLED EGG (WHOLE EGGS, SKIM MILK, SOYBEAN OIL, CORN STARCH, SALT, XANTHAN



Attribute Name	User Friendly Name	Value <i>(Code description italicized)</i>
		GUM, CITRIC ACID), LOW MOISTURE PART SKIM MOZZARELLA CHEESE (CULTURED PASTEURIZED PART SKIM MILK, SALT, ENZYMES), CHEDDAR CHEESE (CULTURED PASTEURIZED MILK, SALT, ENZYMES, ANNATTO [COLOR]), WATER, PALM OIL, YEAST, CONTAINS 2% OR LESS OF: VEGETABLE OIL (SOYBEAN AND/OR CANOLA OIL), MODIFIED FOOD STARCH, SALT, SUGAR, CREAM, BUTTER (CREAM, SALT), SPICE, WHEAT STARCH, DEFATTED SOY FLOUR, SOY LECITHIN, HICKORY SMOKE POWDER (MALTODEXTRIN POWDER, NATURAL HICKORY SMOKE FLAVOR), L-CYSTEINE HYDROCHLORIDE, AMMONIUM SULFATE, NATURAL FLAVOR, ASCORBIC ACID.
ingredientSequence	Sequence number of ingredient	01
ingredientName	Ingredient Name	ENRICHED FLOUR
ingredientSequence	Sequence number of sub ingredient of 1 st level	01.01
ingredientName	Ingredient Name	WHEAT FLOUR
ingredientSequence	Sequence number of sub ingredient of 1 st level	01.02
ingredientName	Ingredient Name	MALTED BARLEY FLOUR
ingredientSequence	Sequence number of sub ingredient of 1 st level	01.03
ingredientName	Ingredient Name	NIACIN
ingredientSequence	Sequence number of sub ingredient of 1 st level	01.04
ingredientName	Ingredient Name	REDUCED IRON
ingredientSequence	Sequence number of sub ingredient of 1 st level	01.05
ingredientName	Ingredient Name	THIAMINE MONONITRATE,
ingredientSequence	Sequence number of sub ingredient of 1 st level	01.06
ingredientName	Ingredient Name	RIBOFLAVIN
ingredientSequence	Sequence number of sub ingredient of 1 st level	01.07
ingredientName	Ingredient Name	FOLIC ACID
ingredientSequence	Sequence number of ingredient	02
ingredientName	Ingredient Name	NONFAT MILK
ingredientSequence	Sequence number of ingredient	03
ingredientName	Ingredient Name	BACON WITH SMOKE FLAVORING ADDED

Attribute Name	User Friendly Name	Value <i>(Code description italicized)</i>
ingredientSequence	Sequence number of sub ingredient of 1 st level	03.01
ingredientName	Ingredient Name	CURED WITH WATER
ingredientSequence	Sequence number of sub ingredient of 1 st level	03.02
ingredientName	Ingredient Name	SALT
ingredientSequence	Sequence number of sub ingredient of 1 st level	03.03
ingredientName	Ingredient Name	SUGAR
ingredientSequence	Sequence number of sub ingredient of 1 st level	03.04
ingredientName	Ingredient Name	SMOKE FLAVORING
ingredientSequence	Sequence number of sub ingredient of 1 st level	03.05
ingredientName	Ingredient Name	SODIUM PHOSPHATES
ingredientSequence	Sequence number of sub ingredient of 1 st level	03.06
ingredientName	Ingredient Name	SODIUM ERYTHORBATE
ingredientSequence	Sequence number of sub ingredient of 1 st level	03.07
ingredientName	Ingredient Name	SODIUM NITRITE
ingredientSequence	Sequence number of ingredient	04
ingredientName	Ingredient Name	SCRAMBLED EGG
ingredientSequence	Sequence number of sub ingredient of 1 st level	04.01
ingredientName	Ingredient Name	WHOLE EGGS
ingredientSequence	Sequence number of sub ingredient of 1 st level	04.02
ingredientName	Ingredient Name	SKIM MILK
ingredientSequence	Sequence number of sub ingredient of 1 st level	04.03
ingredientName	Ingredient Name	SOYBEAN OIL
ingredientSequence	Sequence number of sub ingredient of 1 st level	04.04
ingredientName	Ingredient Name	CORN STARCH
ingredientSequence	Sequence number of sub ingredient of 1 st level	04.05
ingredientName	Ingredient Name	SALT
ingredientSequence	Sequence number of sub ingredient of 1 st level	04.06
ingredientName	Ingredient Name	XANTHAN GUM
ingredientSequence	Sequence number of sub ingredient of 1 st level	04.07



Attribute Name	User Friendly Name	Value <i>(Code description italicized)</i>
ingredientName	Ingredient Name	CITRIC ACID
ingredientSequence	Sequence number of ingredient	05
ingredientName	Ingredient Name	LOW MOISTURE PART SKIM MOZZARELLA CHEESE
ingredientSequence	Sequence number of sub ingredient of 1 st level	05.01
ingredientName	Ingredient Name	CULTURED PASTEURIZED PART SKIM MILK
ingredientSequence	Sequence number of sub ingredient of 1 st level	05.02
ingredientName	Ingredient Name	SALT
ingredientSequence	Sequence number of sub ingredient of 1 st level	05.03
ingredientName	Ingredient Name	ENZYMES
ingredientSequence	Sequence number of ingredient	06
ingredientName	Ingredient Name	CHEDDAR CHEESE
ingredientSequence	Sequence number of sub ingredient of 1 st level	06.01
ingredientName	Ingredient Name	CULTURED PASTEURIZED MILK,
ingredientSequence	Sequence number of sub ingredient of 1 st level	06.02
ingredientName	Ingredient Name	SALT
ingredientSequence	Sequence number of sub ingredient of 1 st level	06.03
ingredientName	Ingredient Name	ENZYMES
ingredientSequence	Sequence number of sub ingredient of 1 st level	06.04
ingredientName	Ingredient Name	ANNATTO
ingredientPurpose	Ingredient Purpose	COLOR
ingredientSequence	Sequence number of ingredient	07
ingredientName	Ingredient Name	Water
ingredientSequence	Sequence number of ingredient	08
ingredientName	Ingredient Name	Palm Oil
ingredientSequence	Sequence number of ingredient	09
ingredientName	Ingredient Name	Yeast
ingredientSequence	Sequence number of ingredient	10
ingredientName	Ingredient Name	Vegetable Oil
ingredientSequence	Sequence number of sub ingredient of 1 st level	10.01
ingredientName	Ingredient Name	Soybean and/or Canola Oil
ingredientSequence	Sequence number of ingredient	11
ingredientName	Ingredient Name	Modified Food Starch

Attribute Name	User Friendly Name	Value <i>(Code description italicized)</i>
ingredientSequence	Sequence number of ingredient	12
ingredientName	Ingredient Name	Salt
ingredientSequence	Sequence number of ingredient	13
ingredientName	Ingredient Name	Sugar
ingredientSequence	Sequence number of ingredient	14
ingredientName	Ingredient Name	Cream
ingredientSequence	Sequence number of ingredient	15
ingredientName	Ingredient Name	Butter
ingredientSequence	Sequence number of sub ingredient of 1 st level	15.01
ingredientName	Ingredient Name	Cream
ingredientSequence	Sequence number of sub ingredient of 1 st level	15.02
ingredientName	Ingredient Name	Salt
ingredientSequence	Sequence number of ingredient	16
ingredientName	Ingredient Name	Spice
ingredientSequence	Sequence number of ingredient	17
ingredientName	Ingredient Name	Wheat Starch
ingredientSequence	Sequence number of ingredient	18
ingredientName	Ingredient Name	Defatted Soy Flour
ingredientSequence	Sequence number of ingredient	19
ingredientName	Ingredient Name	Soy Lecithin
ingredientSequence	Sequence number of ingredient	20
ingredientName	Ingredient Name	Hickory Smoke Powder
ingredientSequence	Sequence number of sub ingredient of 1 st level	20.01
ingredientName	Ingredient Name	MALTODEXTRIN POWDER
ingredientSequence	Sequence number of sub ingredient of 1 st level	20.02
ingredientName	Ingredient Name	NATURAL HICKORY SMOKE FLAVOR
ingredientSequence	Sequence number of ingredient	21
ingredientName	Ingredient Name	L-CYSTEINE HYDROCHLORIDE
IngredientSequence	Sequence number of ingredient	22
ingredientName	Ingredient Name	Ammonium Sulfate
IngredientSequence	Sequence number of ingredient	23
ingredientName	Ingredient Name	Natural Flavor
IngredientSequence	Sequence number of ingredient	24
ingredientName	Ingredient Name	Ascorbic Acid

32.17 Example 14: Nutrition Facts

- **Note:** This example illustrates how information given on the label actually translates into master data in GDS.

Nutrition Facts	
Serving Size 1 piece (166g)	
Servings Per Container 2	
Amount Per Serving	
Calories 440	Calories from Fat 190
% Daily Value*	
Total Fat 21g	32%
Saturated Fat 11g	54%
Trans Fat 0g	
Cholesterol 100mg	33%
Sodium 890mg	37%
Potassium 270mg	8%
Total Carbohydrate 47g	16%
Dietary Fiber 1g	6%
Sugars 10g	
Protein 17g	
Vitamin A 4%	• Vitamin C 0%
Calcium 20%	• Iron 20%
*Percent Daily Values are based on a 2,000 calorie diet. Your daily values may be higher or lower depending on your calorie needs:	
	Calories: 2,000 2,500
Total Fat	Less than 65g 80g
Saturated Fat	Less than 20g 25g
Cholesterol	Less than 300mg 300mg
Sodium	Less than 2,400mg 2,400mg
Potassium	3,500 mg 3,500 mg
Total Carbohydrate	300g 375g
Dietary Fiber	25g 30g
Calories per gram:	
	Fat 9 • Carbohydrate 4 • Protein 4

Attribute Name	User Friendly Name	Value <i>(description in italics)</i>
Module: FoodAndBeveragePreparationServingModule		
numberOfServingsPerPackage	Number of Servings per Package	2
numberOfServingsPerPackage MeasurementPrecisionCode	Measurement Precision Code for Number of Servings per Package	EXACTLY
Module: NutritionalInformationModule		
Food Beverage Composition Class		
foodBeverageComposition DatabaseCode	Nutrient Database (used when no NLEA panel but a USDA NDB#)	USDA
foodBeverageCompositionCode	Code Value from Composition Database	21149
foodBeverageComposition Description	Description of the code from Composition Database	Breakfast pizza frozen
Nutrient Header Class		
dailyValueIntakeReference	Daily Value Intake Reference	Percent Daily Values are based on a 2,000 calorie diet.
preparationStateCode	Preparation State	UNPREPARED

Attribute Name	User Friendly Name	Value <i>(description in italics)</i>
nutrientBasisQuantity TypeCode	Nutrient Basis Quantity Type Code	BY_SERVING
nutrientBasisQuantity	<i>H87 = Code for piece</i>	Either 1 H87 or 166 GRM
servingSizeDescription	Serving Size Description (formerly Household Serving Size)	1 piece (166g)
servingSize	Serving Size	1 H87
servingSizeGramWeight	Serving Size in Grams	166 GRM
nutrientRelevantDataProvided	Is all nutrient data provided	TRUE
nutrientValueDerivation	How the nutrient data is gathered	ANALYTICAL_AND_CALCULATED
Nutrient Detail Class		
nutrientTypeCode	Nutrient Type Code	ENER-: <i>Calories</i>
measurementPrecisionCode	Measurement Precision	Approximately
quantityContained	Nutrient Quantity and Unit of Measure	440 E14 Kilocalorie / Calorie*
nutrientTypeCode	Nutrient Type Code	ENERPF: <i>Calories from Fat</i>
measurementPrecisionCode	Measurement Precision	Approximately
quantityContained	Nutrient Quantity and Unit of Measure	190 E14 Kilocalorie / Calorie*
nutrientTypeCode	Nutrient Type Code	FATNLEA: <i>Total Fat</i>
measurementPrecisionCode	Measurement Precision	Approximately
quantityContained	Nutrient Quantity and Unit of Measure	21 GRM
dailyValueIntakePercent MeasurementPrecisionCode	Daily Value Intake Percent Measurement Precision	Approximately
dailyValueIntakePercent	Daily Value Intake Percent	32
nutrientTypeCode	Nutrient Type Code	FASAT: <i>Saturated Fat</i>
measurementPrecisionCode	Measurement Precision	Approximately
quantityContained	Nutrient Quantity and Unit of Measure	11 GRM
dailyValueIntakePercent MeasurementPrecisionCode	Daily Value Intake Percent Measurement Precision	Approximately
dailyValueIntakePercent	Daily Value Intake Percent	54
nutrientTypeCode	Nutrient Type Code	FATRNR: <i>Trans Fat</i>
measurementPrecisionCode	Measurement Precision	Approximately
quantityContained	Nutrient Quantity and Unit of Measure	0 GRM
nutrientTypeCode	Nutrient Type Code	CHOL: <i>Cholesterol</i>
measurementPrecisionCode	Measurement Precision	Approximately
quantityContained	Nutrient Quantity and Unit of Measure	100 MGM
dailyValueIntakePercent MeasurementPrecisionCode	Daily Value Intake Percent Measurement Precision	Approximately
dailyValueIntakePercent	Daily Value Intake Percent	33
nutrientTypeCode	Nutrient Type Code	NA: <i>Sodium</i>

Attribute Name	User Friendly Name	Value <i>(description in italics)</i>
measurementPrecisionCode	Measurement Precision	Approximately
quantityContained	Nutrient Quantity and Unit of Measure	890 MGM
dailyValueIntakePercent MeasurementPrecisionCode	Daily Value Intake Percent Measurement Precision	Approximately
dailyValueIntakePercent	Daily Value Intake Percent	37
nutrientTypeCode	Nutrient Type Code	K: <i>Potassium</i>
measurementPrecisionCode	Measurement Precision	Approximately
quantityContained	Nutrient Quantity and Unit of Measure	270 MGM
dailyValueIntakePercent MeasurementPrecisionCode	Daily Value Intake Percent Measurement Precision	Approximately
dailyValueIntakePercent	Daily Value Intake Percent	8
nutrientTypeCode	Nutrient Type Code	CHO-: <i>Total Carbohydrate</i>
measurementPrecisionCode	Measurement Precision	Approximately
quantityContained	Nutrient Quantity and Unit of Measure	47 GRM
dailyValueIntakePercent MeasurementPrecisionCode	Daily Value Intake Percent Measurement Precision	Approximately
dailyValueIntakePercent	Daily Value Intake Percent	16
nutrientTypeCode	Nutrient Type Code	FIBTSW: <i>Dietary Fiber</i>
measurementPrecisionCode	Measurement Precision	Approximately
quantityContained	Nutrient Quantity and Unit of Measure	1 GRM
dailyValueIntakePercent MeasurementPrecisionCode	Daily Value Intake Percent Measurement Precision	Approximately
dailyValueIntakePercent	Daily Value Intake Percent	6
nutrientTypeCode	Nutrient Type Code	SUGAR: <i>Sugars</i>
measurementPrecisionCode	Measurement Precision	Approximately
quantityContained	Nutrient Quantity and Unit of Measure	10 GRM
nutrientTypeCode	Nutrient Type Code	PRO-: <i>Protein</i>
measurementPrecisionCode	Measurement Precision	Approximately
quantityContained	Nutrient Quantity and Unit of Measure	17 GRM
nutrientTypeCode	Nutrient Type Code	VITA-: <i>Vitamin A</i>
dailyValueIntakePercent MeasurementPrecisionCode	Daily Value Intake Percent Measurement Precision	Approximately
dailyValueIntakePercent	Daily Value Intake Percent	4
nutrientTypeCode	Nutrient Type Code	VITC-: <i>Vitamin C</i>
dailyValueIntakePercent MeasurementPrecisionCode	Daily Value Intake Percent Measurement Precision	Approximately
dailyValueIntakePercent	Nutrient Type Code	0
nutrientTypeCode	Nutrient Type Code	CA: <i>Calcium</i>

Attribute Name	User Friendly Name	Value <i>(description in italics)</i>
dailyValueIntakePercent MeasurementPrecisionCode	Daily Value Intake Percent Measurement Precision	Approximately
dailyValueIntakePercent	Daily Value Intake Percent	20
nutrientTypeCode	Nutrient Type Code	FE: <i>Iron</i>
dailyValueIntakePercent MeasurementPrecisionCode	Daily Value Intake Percent Measurement Precision	Approximately
dailyValueIntakePercent	Daily Value Intake Percent	20

For additional serving sizes (including 100 GRM), repeat these two Classes:

- Nutrient Header Class
- Nutrient Detail Class

32.18 Example 15: Preparation (Instructions)

- **Note:** This example illustrates how information given on the label actually translates into master data in GDS.



Attribute Name	User Friendly Name	Value
Module: FoodAndBeveragePreparationServingModule		
preparationTypeCode	Preparation Method	MICROWAVE
preparationInstructions	Preparation Instructions	MICROWAVE COOKING INSTRUCTIONS (1100 WATTS) NOTE: Only cook 1 tray at a time. 1. Remove pizza from carton. Remove overwrap from tray and pizza. 2. Place frozen pizza directly on the silver cooking surface, and then place on a microwave-safe plate. 3. Cook on HIGH (100% power) for 2 to 3 minutes. Product is ready when cheese is completely melted. Carefully remove product from microwave and let cool for 1 minute before serving.

CONVENTIONAL OVEN COOKING INSTRUCTIONS

1 PREHEAT OVEN TO 375°F. PLACE OVEN RACK IN CENTER POSITION.	2 REMOVE PIZZA FROM CLEAR PLASTIC WRAP, DISCARD PLASTIC AND SILVER COOKING TRAY. CAUTION: DO NOT USE TRAY IN OVEN.	3 WHEN OVEN IS PREHEATED, PLACE FROZEN PIZZA ON A COOKIE SHEET AND THEN PLACE ON THE CENTER RACK.	4 BAKE FOR 21-24 MINUTES OR UNTIL CHEESE IS MELTED AND LIGHTLY BROWNED.
---	---	--	--

• LET PIZZA COOL FOR 2-3 MINUTES BEFORE SERVING.

Attribute Name	User Friendly Name	Value
Module: FoodAndBeveragePreparationServingModule		
preparationTypeCode	Preparation Method	BAKE
preparationInstructions	Preparation Instructions	CONVENTIONAL OVEN COOKING INSTRUCTIONS 1. Preheat oven to 375°F. Place oven rack in center position. 2. Remove pizza from clear plastic wrap. Discard plastic and silver cooking tray. CAUTION: Do not use tray in oven. 3. When oven is preheated, place frozen pizza on a cookie sheet and then place on the center rack. 4. Bake for 21-24 minutes or until cheese is melted and lightly browned. Let pizza cool for 2-3 minutes before serving.
servingSuggestion	Serving Suggestion(s)	Serve with fruits and vegetables for a well-balanced meal Great for Breakfast, Lunch or Dinner Microwave or Oven Bake

32.19 Example 16: Food Service Master Case Label

- **Note:** This example illustrates how information given on the label actually translates into master data in GDS.



GTIN, Brand & Descriptions, and Declared Net Content & Statement of Piece Count

Attribute Name	User Friendly Name	Value
GTIN	Global Trade Item Number	10012345678902
Module: TradeItemDataCarrierAndIdentificationModule		
gs1TradeItemIdentification KeyCode	EAN UCC Code Type	GTIN_14
dataCarrierTypeCode	Bar Code Type	ITF_14
Module: TradeItemDescriptionModule		
brandName	Brand Name	Asian Great
subBrand	Sub Brand	
functionalName	Functional Name	Sauce
tradeItemVariantTypeCode	Variant Descriptor	FLAVOUR
tradeItemVariantValue	Variant Value	Szechwan
Module: TradeItem		
gtinName	GTIN Name	Asian Great Less Sodium Szechwan Sauce
Module: TradeItemMeasurementsModule		
netContent/UOM	Declared Net Content	5 EA
netWeight/UOM	Net Case Weight	30 LBR
grossWeight/UOM	Gross Case Weight	31.05 LBR
Module: Currently is an AVP		
ShippingContainer ContentsDescription	Pack Size Text	CONTAINS: 5-6 LB POUCHES

Ingredients

Attribute Name	User Friendly Name	Value
Module: FoodAndBeverageIngredientModule		
ingredientStatement	Ingredient Statement	INGREDIENTS: WATER, SUGAR, SOY SAUCE (WATER, WHEAT, SOYBEANS, SALT, LACTIC ACID, AND LESS THAN 0.10% SODIUM BENZOATE AS A PRESERVATIVE), SAUTERNE COOKING WINE (SAUTERNE WINE, SALT), CHILI GARLIC SAUCE (RED CHILI PEPPER, VINEGAR, SALT, GARLIC, XANTHAN GUM, GUAR GUM, NATURAL FLAVORS), VINEGAR, MODIFIED FOOD STARCH, DEHYDRATED GARLIC CONTAINS 2% OR LESS OF: COTTONSEED OIL, SOYBEANS, SALT, DEHYDRATED ONION, MOLASSES POWDER (CANE REFINERY SYRUPS, CANE MOLASSES), TOASTED SESAME OIL, SPICE, WHEAT FLOUR, XANTHAN GUM, WHEY, POWDERED CELLULOSE, DISODIUM GUANYLATE, DISODIUM INOSINATE, MALTODEXTRIN, MUSHROOM EXTRACT, NATURAL FLAVOR, MIXED TRIGLYCERIDES, SUCCINIC ACID, MANNITOL.
ingredientSequence	Sequence number of ingredient	01
ingredientName	Ingredient Name	WATER
ingredientSequence	Sequence number of ingredient	02
ingredientName	Ingredient Name	SUGAR
ingredientSequence	Sequence number of ingredient	03
ingredientName	Ingredient Name	SOY SAUCE
ingredientSequence	Sequence number of sub ingredient of 1 st level	03.01
ingredientName	Ingredient Name	WATER
ingredientSequence	Sequence number of sub ingredient of 1 st level	03.02
ingredientName	Ingredient Name	WHEAT
ingredientSequence	Sequence number of sub ingredient of 1 st level	03.03
ingredientName	Ingredient Name	SOYBEANS
ingredientSequence	Sequence number of sub ingredient of 1 st level	03.04
ingredientName	Ingredient Name	SALT
ingredientSequence	Sequence number of sub ingredient of 1 st level	03.05
ingredientName	Ingredient Name	LACTIC ACID
ingredientSequence	Sequence number of sub ingredient of 1 st level	03.06

ingredientName	Ingredient Name	LESS THAN 1% SODIUM BENZOATE
ingredientPurpose	Ingredient Purpose	PRESERVATIVE
Continue for all remaining ingredients.		

Allergens

Attribute Name	User Friendly Name	Value <i>(Code description italicized)</i>
Module: AllergenInformationModule		
allergenSpecificationAgency	Allergen Specification Agency	FDA
allergenSpecificationName	Allergen Specification Name	21 USC 343
allergenStatement	Allergen Statement	Contains: Soy, Wheat, Milk
allergenRelevantDataProvided	Is all allergen data provided	TRUE
Allergen Class		
allergenTypeCode	Allergen Type Code	<i>AY: Soybeans and their derivatives</i>
levelOfContainmentCode	Level of Containment	Contains
allergenTypeCode	Allergen Type Code	<i>UW: Wheat and it's derivatives</i>
levelOfContainmentCode	Level of Containment	Contains
allergenTypeCode	Allergen Type Code	<i>AM: Milk and it's derivatives</i>
levelOfContainmentCode	Level of Containment	Contains

Nutritional Details

Attribute Name	User Friendly Name	Value <i>(description in italics)</i>
Module: FoodAndBeveragePreparationServingModule		
numberOfServingsPerPackage	Number of Servings per Package	400
numberOfServingsPerPackage MeasurementPrecisionCode	Measurement Precision Code for Number of Servings per Package	Approximately
Module: NutritionalInformationModule		
Food Beverage Composition Class		
foodBeverageComposition DatabaseCode	Nutrient Database (used when no NLEA panel but a USDA NDB#)	USDA
foodBeverageCompositionCode	Code Value from Composition Database	16124
foodBeverageComposition Description	Description of the code from Composition Database	Szechwan Sauce
Nutrient Header Class		
dailyValueIntakeReference	Daily Value Intake Reference	Percent Daily Values are based on a 2,000 calorie diet.
preparationStateCode	Preparation State	UNPREPARED
nutrientBasisQuantity TypeCode	Nutrient Basis Quantity	BY_SERVING
nutrientBasisQuantity	<i>G24 = Code for tablespoon</i>	Either 2 G24 or 34 GRM
servingSizeDescription	Serving Size Description (formerly Household Serving Size)	2 Tbsp (34g)
nutrientRelevantDataProvided	Is all nutrient data provided	TRUE
nutrientValueDerivation	How the nutrient data is gathered	ANALYTICAL_AND_CALCULATED

Attribute Name	User Friendly Name	Value <i>(description in italics)</i>
Nutrient Detail Class		
nutrientTypeCode	Nutrient Type Code	ENER-: <i>Calories</i>
measurementPrecisionCode	Measurement Precision	Approximately
quantityContained	Nutrient Quantity and Unit of Measure	35 E14 Kilocalorie / Calorie*
nutrientTypeCode	Nutrient Type Code	ENERPF: <i>Calories from Fat</i>
measurementPrecisionCode	Measurement Precision	Approximately
quantityContained	Nutrient Quantity and Unit of Measure	10 E14 Kilocalorie / Calorie*
nutrientTypeCode	Nutrient Type Code	FATNLEA: <i>Total Fat</i>
measurementPrecisionCode	Measurement Precision	Approximately
quantityContained	Nutrient Quantity and Unit of Measure	1 GRM
dailyValueIntakePercent MeasurementPrecisionCode	Daily Value Intake Percent Measurement Precision	Approximately
dailyValueIntakePercent	Daily Value Intake Percent	1
nutrientTypeCode	Nutrient Type Code	NA: <i>Sodium</i>
measurementPrecisionCode	Measurement Precision	Approximately
quantityContained	Nutrient Quantity and Unit of Measure	300 MGM
dailyValueIntakePercent MeasurementPrecisionCode	Daily Value Intake Percent Measurement Precision	Approximately
dailyValueIntakePercent	Daily Value Intake Percent	13
nutrientTypeCode	Nutrient Type Code	K: <i>Potassium</i>
measurementPrecisionCode	Measurement Precision	Approximately
quantityContained	Nutrient Quantity and Unit of Measure	25 MGM
dailyValueIntakePercent MeasurementPrecisionCode	Daily Value Intake Percent Measurement Precision	Approximately
dailyValueIntakePercent	Daily Value Intake Percent	1
nutrientTypeCode	Nutrient Type Code	CHO-: <i>Total Carbohydrate</i>
measurementPrecisionCode	Measurement Precision	Approximately
quantityContained	Nutrient Quantity and Unit of Measure	6 GRM
dailyValueIntakePercent MeasurementPrecisionCode	Daily Value Intake Percent Measurement Precision	Approximately
dailyValueIntakePercent	Daily Value Intake Percent	2
nutrientTypeCode	Nutrient Type Code	SUGAR: <i>Sugars</i>
measurementPrecisionCode	Measurement Precision	Approximately
quantityContained	Nutrient Quantity and Unit of Measure	4 GRM
nutrientTypeCode	Nutrient Type Code	PRO-: <i>Protein</i>
measurementPrecisionCode	Measurement Precision	Approximately
quantityContained	Nutrient Quantity and Unit of Measure	<1 GRM

Benefits

Attribute Name	User Friendly Name	Value
Module: MarketingInformationModule		
tradeItemMarketingMessage	Benefits	67% Less sodium than a leading brand of Szechwan Sauce. Sodium content has been lowered from 910 to 300 mg per serving.

Preparation Instructions

Attribute Name	User Friendly Name	Value
Module: FoodAndBeveragePreparationServingModule		
preparationTypeCode	Preparation Method	BOIL
preparationInstructions	Preparation Instructions	Sauce is ready to heat and serve. Can be prepared from frozen or refrigerated state. TO HEAT: Bring a large pot of water to boil. Submerge one bag in boiling water and boil for 40 minutes if frozen or 30 minutes if refrigerated.
servingSuggestion	Serving Suggestion(s)	Can be served to add Asian flavour to sandwiches, wraps, bowls, stir fry and more. Can be used as a dipping sauce, marinade, glaze, and base sauce.

Contact Information

Attribute Name	User Friendly Name	Value
Module: TradeItem		
GLN	GLN of Contact Information Provider	xxxxxxxxxxxxx
contactTypeCode	Type of Contact <i>CXC = code for CONSUMER_SUPPORT</i>	CXC
availableTime	Time Contact is Available	7:00 AM-9:00 PM
communicationChannelCode	Type of Communication Channel	TELEPHONE
communicationChannel Number	Phone Number	xxx-xxx-xxxx
communicationChannelCode	Type of Communication Channel	WEBSITE
communicationChannel Number	Website Name	www.xxxxx.com

* E14 Kilocalorie / Calorie - In many countries it remains in common use as a unit of food energy. In the context of nutrition, and especially food labelling, the calorie is approximately equal to 4.1868 joules (J), and energy values are normally quoted in kilojoules (kJ) and kilocalories (kcal).

33 Use of Leading Zeroes

The [GS1 system](#) is a platform that consists of a number of standards for the identification of goods, entities and events, and the capturing and sharing of information about them across sectors and supply chains.

The individual standards that make up the GS1 system have been created at different moments in time based on specific requirements, which has led to some differences in how information is carried and used in each one of these standards.

One such difference pertains to the use of leading zeroes when entering GS1 identification keys across different parts of the GS1 system. For instance, the way a GTIN is expressed can vary across individual standards in the GS1 system.

This section provides guidance on when to include/omit leading zeroes when entering a GTIN in different parts of the GS1 system. It provides the reader with a quick reference about the existing rules when using of leading zeroes.

- **Important:** This guidance is strictly limited to the representation of GTINs and GS1 Identification keys within GS1 standards. It is by no means intended as advice for how trading partners store these GS1 identification keys in their internal systems.

33.1 GTINs and leading zeroes in Data Carriers

The [GS1 General Specifications](#) specify in section 2.1.2.1.1 GTIN Data String that when any GTIN is encoded in a data carrier that must encode a fixed-length data string of 14-digits, the GTINs less than 14-digits in length must be started with leading zeroes that simply act as filler characters.

- **Note:** For more information about Application Identifiers for other GS1 Identification keys please refer to section 2 in the [GS1 General Specifications](#).

33.2 GTINs and leading zeroes in GS1 XML (including GDSN) attributes with data type GTIN

In [GS1 XML](#) (including GDSN messages), the data type of GTIN is defined as 14 numeric characters. Thus, the full 14 digits must be transmitted. Shorter formats (GTIN-8, GTIN-12 and GTIN-13) MUST be filled in with leading zeroes up to 14 digits when the data type of an attribute is "GTIN".

- **Note:** For more information about entering other GS1 identification keys in GS1 XML messages please refer to: [Shared XML Common](#).

33.3 GTINs and leading zeroes in GS1 XML (including GDSN) attributes with data type string

Some attributes used in GS1 XML/GDSN messages can carry a GTIN (or other GS1 identification keys) even though the data type may be a string (unformatted text). Two examples of widely used string-based attributes to carry a GTIN in GDSN are:

- additionalTradeItemIdentification
- returnablePackageDepositCode

These two attributes can be used to synchronise GTIN/GRAI numbers or internal store codes (restricted distribution that usually start with prefix 020 or 200), though they can carry other non-GS1 numbers too. For this reason these attributes do not have a GTIN (or GRAI) data type but rather are specified as text strings.

For attributes such as these the following guidelines can be provided:

The basic guideline for attributes like these is that the usage of leading zeroes for shorter format GTINs (GTIN-8, GTIN-12 and GTIN-13) is to be agreed between trading partners in each target market though using leading zeroes is recommended for the sake of consistency, so that GTINs are populated uniformly on the same message.

- **Important:** The attribute returnablePackageDepositCode can be used to synchronise both GTIN and non-serialised GRAI codes for returnable assets. Since GRAIs are entered as exactly 14 numeric digits, followed by Minimum 0, Maximum 16 alphanumeric characters in GS1 XML messages, it is also recommended to enter non-serialised GRAIs with a leading zero in this attribute.

33.4 Summary

The table below summarises the way leading zeroes are to be used for GTINs across the GS1 system:

Table 33-1 Summary of the way leading zeroes are to be used for GTINs

Standard where the GTIN is used	GS1 Data Carriers	GS1 EANCOM	GS1 XML/GDSN attributes with data type GTIN	GS1 XML/GDSN attributes with data type string
Correct way to populate leading zeroes	When any GTIN is encoded in a data carrier that must encode a fixed-length data string of 14-digits, the GTINs less than 14-digits in length must be prefixed by leading zeroes that simply act as filler characters.	Never add leading zeroes to shorter GTIN formats (GTIN-8, GTIN-12, GTIN-13) in EANCOM.	Shorter GTIN formats (GTIN-8, GTIN-12 and GTIN-13) MUST be filled in with leading zeroes up to 14 digits when the data type of an attribute is "GTIN"	It is recommended to add leading zeroes to shorter format GTINs (GTIN-8, GTIN-12 and GTIN-13) in sting-based attributes, though this is a decision that ultimately needs to be agreed between trading partners in each market.
Source	GS1 General Specifications section 2.1.2.1.1 GTIN Data String	GS1 EANCOM	GS1 XML Implementation Guide Shared XML Common	This entire document
Rationale	Mandated by the usage rules for data carriers.	GS1 Keys have a numeric format in EANCOM, non-significant leading zeroes need to be removed.	In GS1 XML (including GDSN messages), the data type of GTIN is defined as 14 numeric characters. Thus, the full 14 digits must be transmitted.	So adding leading zeroes to GTINs in these string-based attributes helps ensure consistency (GTINs will be populated uniformly on the same message with leading zeroes in both GTIN and string data type attributes).
Example	0 8712345678906	8712345678906	0 8712345678906	0 8712345678906

34 Measurement Unit Codes

34.1 Purpose of this Document

The purpose of this document is for GDSN users to better understand which Measurement Unit Codes should be implemented for which attribute.

For some attributes it is obvious which Measurement Unit Codes should be allowed such as Product Height/Width/Depth, but for others such as Net Content or Order Sizing Factor, this is less obvious. This could lead to data pools implementing different Measurement Unit Codes for the same attribute, which may result in interoperability issues.

As part of this document therefore all Measurement Unit Codes that are used in GDSN (excluding AVPs and Extended Attributes) have been allocated a category. For each GDSN attribute that requires a Measurement Unit Code, recommended category(ies) can be implemented.

34.2 Who Will Use this Document?

The recommendations described in this document should be used by all GDSN users, including data pools, information providers and data recipients.

34.3 Pre-Requisite

N/A

34.4 When Would I Use This?

These guidelines are to be referred to when using GDSN attributes that require the user to populate a valid Unit of Measure.

34.5 GDS Attributes & GDS Units of Measure + Measurement Unit Code Categories

The Unit of Measure codes that are used in GDS grouped by their allocated Measurement Unit Code category, as well as all attributes in GDS (excluding AVPs and Extended Attributes) that are associated with data type Measurement or Quantity and the recommended Measurement Unit Code category(ies) that should be used can be found:

- https://www.gs1.org/docs/gdsn/3.1/UOM_ByCat.xlsx
- **Note:** providing a Unit of Measure for attributes associated with data type Quantity is only required if applicable.

35 Components

35.1 Objective

Describe how to implement and use the class Trade Item Components and Component Information.

35.2 Audience

The audience of this recommendation is any participant in the global supply chain. This includes retailers, manufacturers, service providers and other third parties.

35.3 Definition of the Class Components

The data of the component class is designed to supply information about parts of a trade item. Parts that are different from each other are called heterogeneous products.

The component class is implemented as a repeatable subclass of the trade item.

35.3.1 Component Definition

Components are not a level in the trade item hierarchy, they are simply elements (pieces) of a larger single trade item. They provide detailed information to complement the trade item, i.e., online presentations or product catalogues. A component can be contained in a kit, one of many parts within an item.

A component is a non-marked part of a composite trade item where the component itself is not available to a consumer separately. Together the components make up the item.

An item that is assigned a GTIN and available to purchase by a consumer should not be a component. In this case, the information should be supplied in the trade item information as a hierarchy level and therefore the component class is not used.

In healthcare the Trade Item Components class may be used to communicate information on Units of Use, if a package designated BASE_UNIT_OR_EACH (EA) contains a multitude of those. See section [4.5.8](#) for more information.

35.3.2 Heterogeneous Product

A heterogeneous product is a trade item where the parts differ from each other. For example if the parts of the trade item have different ingredients statements or nutrient information or when the item consist of multiple items that are only available together as a single item.

35.4 Delimitations to similar Attributes and Functionalities in Trade Item

35.4.1 When to use, or not use, components?

Component class should be used to describe parts of a composite trade item, where the different parts are not intended to be available individually. The class can also be used to specify an additional non-marked part that is attached to a trade item and which is not available separately.

The component class should not be used for an item assigned a GTIN and is marked individually, even if such items are packed and available together as a single item. In the case where multiple items which are assigned a GTIN and are marked available within the bundle the information should be structured as trade items in the trade item hierarchy.

The component class can be used when at least one part of trade item is not identified by GTIN. But it shall only be used for parts with no GTIN assigned.

If a promotional item is added to an existing trade item this should in most cases be represented by using the Promotional Item Information Module rather than the component class.

The component class should not be used instead of the trade item information in a hierarchy, but only as a complement to the item information.

The component class should only be used if it gives additional or more detailed information about the components of the trade item.

Components may be used either on consumer or base units. The components should reflect information as it appears on the physical package.

Undeclared information may be included when the manufacturer identifies additional value to the user.

- **Note:** If there are multiple items with assigned GTINs, they will be handled as a multipack item, i.e. a consumer unit containing multiple unique trade items, and should not be identified as components.

35.4.2 Which information should I supply?

- Only information that is unique for the component should be supplied at the component. This could be for example nutrients and ingredients where the different components have their own values
- Any attribute that is supplied on the item should not be repeated on the components unless they have a different value (or vice versa)

35.5 The class and attributes per definition

- **Important:** The table below describes the attributes used in the component class. The attributes to be removed in a future version of GDS have been noted in the definition.

Table 35-1 Trade Item Component Attributes & Component Information

Class/Attribute	Definition
Trade Item Components	A constituent part of a trade item.
Total quantity of components	The total quantity of components included in this trade item. Example Yogurt Vanilla, Chocolate and Strawberry 12 pack this number would be 12
Number of unique components	The number of different types of components included in this trade item. Example Yogurt Vanilla, Chocolate and Strawberry 12 pack this number would be 3
Multiple container quantity	The quantity of containers when the complete trade item is packed in multiple containers. If all components are packed together into one item this attribute is not used
Contents description	Will be deprecated in a future release
Component Information	Component information for a trade item.
Component number	Indicate a sequence number of a component of a trade item.
Component description	A description of the component
Component identification	An identifier for a component.
Context identification	The unique identifier established for the context managed by GS1.
GPC category code	Code specifying a product category according to the GS1 Global Product Classification (GPC) standard.
Component quantity	The amount of a component
Component multiple packed quantity	The quantity of containers when this component of the trade item is packed in multiple containers. If all quantity of this component is packed together into one item this attribute is not used
Extension	An extension point for the trade item.

35.6 How to Implement Components

It is important that the components are implemented as an attachment to the whole trade item information and not as an alternative way of synchronizing information about items - i.e. an item should be by definition either a trade item and the information is then synchronized in the trade item hierarchy or it is **a component and the information is then synchronized in the component class that is attached to the core trade item information.**

If both classes can be used to fulfill the need of information, the trade item hierarchy structure should be used in preference to the component class. If the values are different it can be supplied on both item and component.

35.7 Modules

When components are used, as much information as possible should be described on the item itself. Only information that is unique for the component or that complements the item information should be applied on the component. This means that only modules holding unique or additional information for a component should be used.

Below is a recommended limitation on which modules to use for the component information. Remember that according to the schema all modules are allowed. The reason for this limitation is to make sure that information is supplied as unified as possible independent of the information provider. This recommendation is a local agreement which is maintained by the local user community.

List of recommended modules

- Alcoholic Information Module
- Allergen Information Module
- Animal Feeding Module
- Certification Information Module

- Chemical Regulation Information Module
- Diet Information Module
- Farming Processing Information Module
- Food and Beverage Ingredient Module
- Food and Beverage Preparation Serving Module
- Food and Beverage Properties Information Module
- Healthcare Item Information Module
- Marketing Information Module
- Nonfood Ingredient Module
- Nutritional Information Module
- Packaging Information Module
- Place of Item Activity Module
- Referenced File Detail Information Module
- Regulated Trade Item Module
- Safety Data Sheet Module
- Trade Item Description Module
- Trade Item Disposal Information Module
- Trade Item Licensing Module
- Trade Item Lifespan Module
- Trade Item Measurements Module
- Trade Item Size Module

35.8 Examples of Components

This section provides several examples of components.

35.8.1 Pizza Kit with two components

The trade item is a pizza kit where a jar of tomato sauce and 2 pieces of pizza dough are packed together in a box. The box that make up the kit is assigned a GTIN, has a barcode and is the item that will be available to the consumer.

The table below shows attribute usage for a basic component item:

Table 35-2 Attribute usage for a Basic Component

TradeItemComponents	
totalQuantityOfComponents	3
numberOfUniqueComponents	2
multipleContainerQuantity (AVP)	
ComponentInformation (Tomato sauce)	
componentNumber	1
componentDescription	Tomato sauce
componentIdentification	123456
componentQuantity (AVP)	1
componentMultiplePackedQuantity (AVP)	
Modules used on this item:	
<ul style="list-style-type: none"> ■ Food and Beverage Ingredient Information Module ■ Nutritional Information Module 	
ComponentInformation (Pizza dough)	

componentNumber	2
componentDescription	Pizza dough
componentIdentification	654321
componentQuantity (AVP)	2
componentMultiplePackedQuantity (AVP)	
Modules used on this item:	
<ul style="list-style-type: none"> ■ Food and Beverage Ingredient Information Module ■ Nutritional Information Module 	

Figure 35-1 Trade item hierarchy

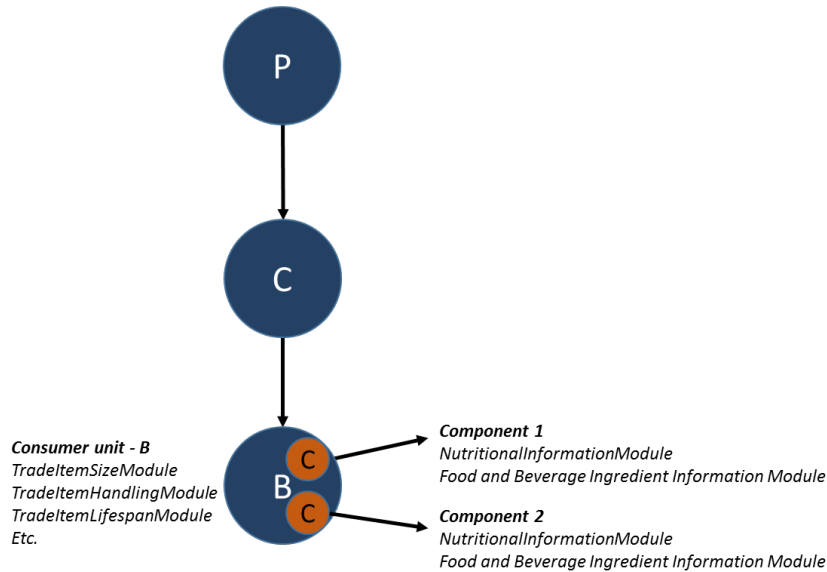

35.8.2 Camping set containing 1 table and 4 chairs

The trade item is complete camping set consisting of 1 table and 4 chairs. The table is packed in one box, the chairs are packed two in each box. The pieces in the set are not available separately. The customer buys the set which includes three boxes.

The example shows how components can be packed in multiple boxes and how this is described using the content description attribute.

The attribute multipleContainerQuantity in the component class have the value of 3 since this is the number of packages that makes up the whole. On the components level the value of the attribute componentMultiplePackedQuantity is 1 on both the chairs and the table since each component only consist of one package.

If the chairs would have had 2 cushions included and the cushions packaged individually the number of packages on the chair component would have been 3:1 package containing 2 chairs, 1 package containing cushion 1 and 1 package containing cushion 2.

The table below shows attribute usage for a multi container component item:

Table 35-3 Attribute usage for a Multi Container Component

TradeItemComponents	
totalQuantityOfComponents	3
numberOfUniqueComponents	2
multipleContainerQuantity (AVP)	3
ComponentInformation (Chairs)	
componentNumber	1

componentDescription	2-pack camping chairs
componentIdentification	111111
componentQuantity (AVP)	2
componentMultiplePackedQuantity (AVP)	1
ComponentInformation (Table)	
componentNumber	2
componentDescription	Camping table
componentIdentification	222222
componentQuantity (AVP)	1
componentMultiplePackedQuantity (AVP)	1

35.8.3 A multipack with four different ice creams with different nutritional information, ingredient statements and/or allergen information

The trade item is a multipack containing four different ice creams. The mini versions are not sold separately.

Each individual ice cream may provide unique information:

- ingredients
- nutritional information
- marketing statements
- allergen information
- etc.

The example shows how to supply component information for an item that has unique labels for each component and all are displayed on the trade item.

Note that the Allergen information attribute may be repeated on both components and in the core information since they may hold different values. If one component contains peanuts and another walnuts, each component information will state the allergen contained in the component, while the item information may state the combined list, e.g. both peanut and walnut.



The table below shows attribute usage for components with different ingredient information:

Table 35-4 Attribute usage for a Component with different ingredients

TradeItemComponents	
totalQuantityOfComponents	4

numberOfUniqueComponents	4
multipleContainerQuantity (AVP)	
ComponentInformation (Component 1)	
componentNumber	1
componentDescription	Cookie dough
componentIdentification	AA11
componentQuantity (AVP)	1
componentMultiplePackedQuantity (AVP)	
Modules used on this item: <ul style="list-style-type: none"> • Food and Beverage Ingredient Information Module • Nutritional Information Module • Allergen Information Module 	
ComponentInformation (Component 2)	
componentNumber	2
componentDescription	Chocolate fudge brownie
componentIdentification	BB22
componentQuantity (AVP)	1
componentMultiplePackedQuantity (AVP)	
Modules used on this item: <ul style="list-style-type: none"> • Food and Beverage Ingredient Information Module • Nutritional Information Module • Allergen Information Module 	
ComponentInformation (Component 3)	
componentNumber	3
componentDescription	Peanut butter cup
componentIdentification	CC33
componentQuantity (AVP)	1
componentMultiplePackedQuantity (AVP)	
Modules used on this item: <ul style="list-style-type: none"> • Food and Beverage Ingredient Information Module • Nutritional Information Module • Allergen Information Module 	
ComponentInformation (Component 4)	
componentNumber	4
componentDescription	Chunky Monkey
componentIdentification	DD44
componentQuantity (AVP)	1
componentMultiplePackedQuantity (AVP)	
Modules used on this item: <ul style="list-style-type: none"> • Food and Beverage Ingredient Information Module • Nutritional Information Module • Allergen Information Module 	

In the following additional example; the components differ by:

- **Format** such as ice cream cone, sandwich, or twist
- **Weight** of each individual component may differ
- **Quantity** of each component
- Etc.



35.8.4 Resin Kit with Hazardous Information

The trade item consists of putty and a hardener. The can with the putty has a special plastic lid. Under this lid there is a small tube which contains the hardener (e.g. peroxide). Both products (putty and hardener) have different chemical regulation information, safety data sheet information, and any additional regulated trade item data.

In many cases the hazardous information data can differ between the item and its components. This example provides the UN-Numbers:

- **3269** - POLYESTER RESIN KIT
- **1866** - RESIN SOLUTION, flammable
- **3105** - ORGANIC PEROXIDE TYPE D, LIQUID

Both item and each individual component may therefore have unique information in the Safety Data Sheet Module.

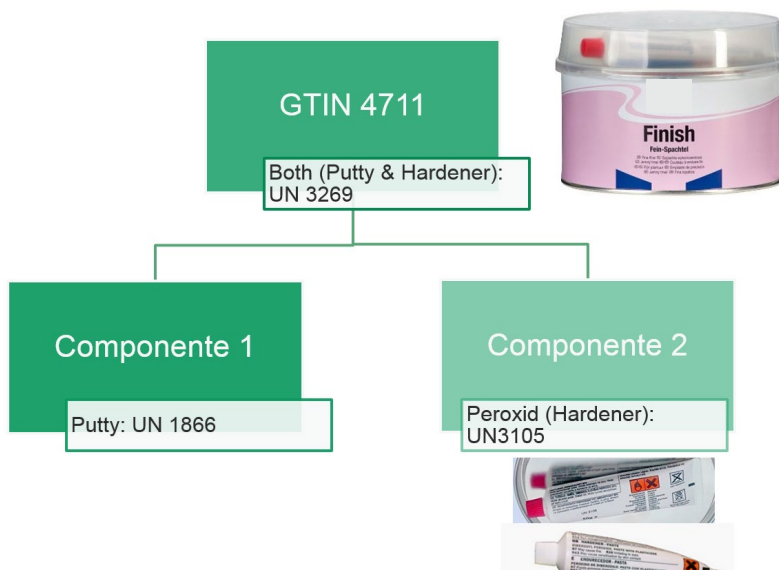

35.8.5 Perfume or Essential oils with hazardous information

The trade item is a set of 28 bottles, 10 ml each of different perfume or essential oils. Each bottle contains a different mixture.

The mixture is flammable with a flash point which may differ between 50- 60°C.

A marketing message may identify:

“The lethal dose for the common oils are different (e.g. lemon myrtle with an oral lethal dose of 2.43 g/kg or hot oil [cinnamomum camphora, oil extracted from leaves] with an oral lethal dose of 3.80 g/kg.”

Both item and each individual component may therefore have unique information in the Safety Data Sheet Module attributes.

Gefährliche Inhaltsstoffe:		
CAS: 69011-36-3	Isotridecanol, ethoxiliert (>5-20 EO)	5%
NLP: 500-241-6	Xn, Xi, R 22-41	
CAS: 68411-31-4	Benzolsulfonsäure, C10-13-Alkylderivate, Verbindungen mit Triethanolamin	10%
EINECS: 270-116-6	Xi, R 38-41	
CAS: 5989-27-5	Orangenterpene	< 2,5%
EINECS: 227-813-5	Xi, N, R 10-38-43-50/53	
CAS: 32210-23-4	(4-tert-Butylcyclohexyl)-acetat	< 2,5%
EINECS: 250-954-9	N, R 51/53	
CAS: 2050-08-0	Pentylsalicylat	< 2,5%
EINECS: 218-080-2	Xn, N, R 22-51/53	

Gefährliche Inhaltsstoffe:		
CAS: 69011-36-3	Isotridecanol, ethoxiliert (>5-20 EO)	5%
NLP: 500-241-6	Xn, Xi, R 22-41	
CAS: 68411-31-4	Benzolsulfonsäure, C10-13-Alkylderivate, Verbindungen mit Triethanolamin	10%
EINECS: 270-116-6	Xi, R 38-41	
CAS: 5989-27-5	Orangenterpene	< 2,5%
EINECS: 227-813-5	Xi, N, R 10-38-43-50/53	
CAS: 32210-23-4	(4-tert-Butylcyclohexyl)-acetat	< 2,5%
EINECS: 250-954-9	N, R 51/53	
CAS: 2050-08-0	Pentylsalicylat	< 2,5%
EINECS: 218-080-2	Xn, N, R 22-51/53	

35.9 Examples of items where components should not be used

35.9.1 Gift pack consisting of one bottle of shampoo and one bottle of conditioner

The trade item is a gift pack that contains a bottle of shampoo and a bottle of conditioner. They are available individually and both are assigned a GTIN and marked with a barcode. In this item the two bottles are wrapped together.

For this item it is not recommended to use the component class, since the two items that it contains are available individually. The item should be supplied as a trade item hierarchy where the shampoo and conditioner are base units in the hierarchy and the gift pack is the consumer unit.

Figure 35-2 Trade item hierarchy

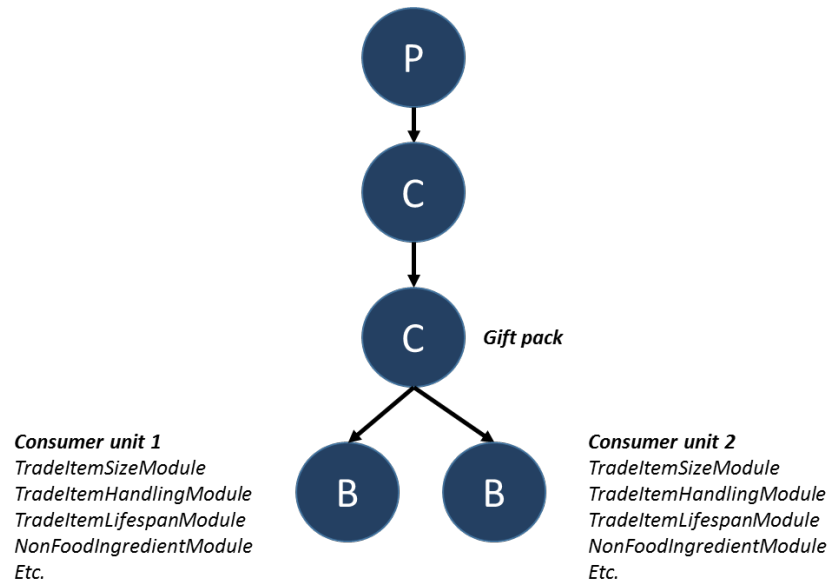

35.9.2 A multipack with three different sausages which are individually packed and marked (not components)

The trade item is a barbeque assortment of sausages. There are three types of sausages in the pack. Each type is pre-packed and are also available to the consumer individually. In this item they are packed together on a single plastic tray but still in their individual packages as well. Each type has different ingredients and the information is supplied on the package for each type of sausage.

The example shows that if the trade item information can be supplied without the component class, there is no need to use the component class. It is better to supply the information using the information available in the trade item hierarchy.

Figure 35-3 Trade item hierarchy

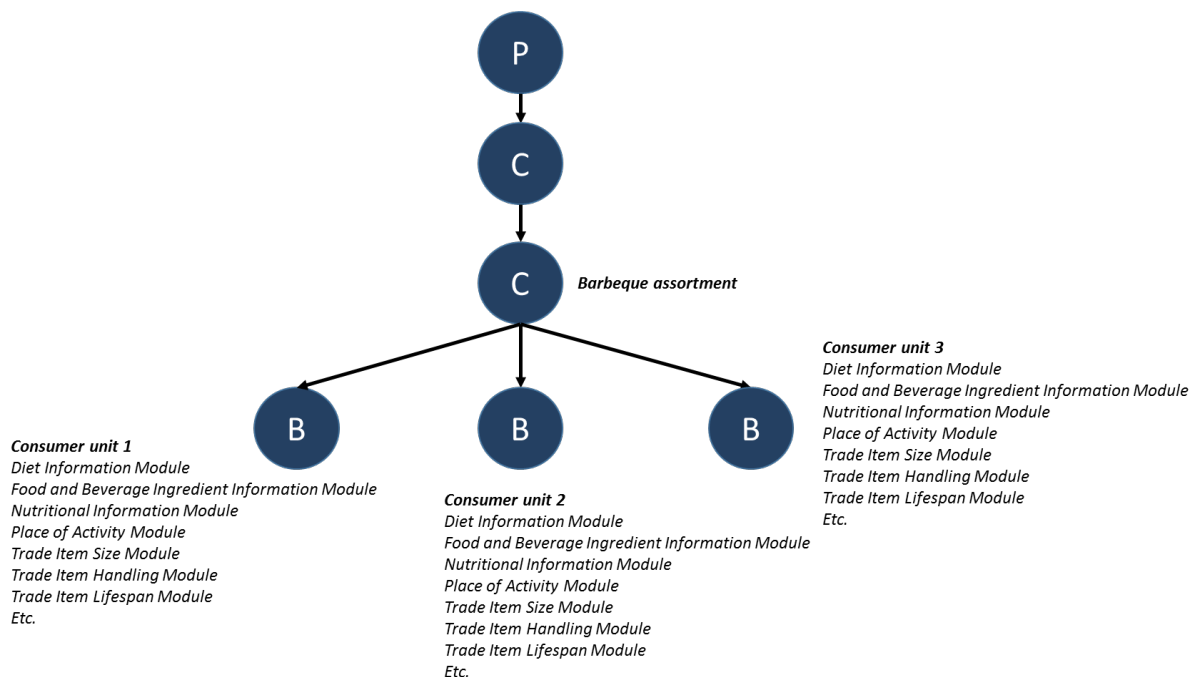

36 Target Markets

This section deals with the usage of GS1 additional country codes and how they should be used for Target Market.

36.1 Country Code usage for indicating Target Market

36.1.1 Country code

The three digit numeric code (numeric-3) of ISO 3166-1, *International Standard for country codes and codes for their subdivisions*, is used within GDSN to indicate countries, dependencies, and other areas. The following GS1 additional country codes are:

- **001** - World or Global Market:
 - This code is part of the UN M.49 standard which is the reference for ISO 3166-1 3 numeric codification (see https://en.wikipedia.org/wiki/ISO_3166-1 ,ISO 3166-1 numeric – three-digit country codes which are identical to those developed and maintained by the United Nations Statistics Division, with the advantage of script (writing system) independence, and hence useful for people or systems using non-Latin scripts.) The full information about UN M.49 standard is available here: <https://unstats.un.org/unsd/methodology/m49> (clik on Geographic Regions)
 - Should only be used for all messaging relative to Target Market, Publication, Subscription, Registration, etc.
 - Cannot be used as country specific to an attribute like countryOfOrigin, etc.
 - See section 1.1.2 for further implementation consideration.
- **D_A** – Development Assistance:
 - This code is a GS1 maintained code for GS1 Healthcare for countries in stages of developing. Assistance is provided to support these countries by organisations that work in countries that may not be using GDSN.
 - Should only be used for all messaging relative to Target Market, Publication, Subscription, Registration, etc.
 - Cannot be used as country specific to an attribute like countryOfOrigin, etc.
 - See section 1.1.2 for further implementation consideration.
- **097** - European Union:
 - Mainly implemented for use in country code attributes.
 - Can be used for Publication, Subscription and Registration (e.g., Target Market) when sending information to European institution for regulatory programs such as EUDAMED.
- **NON_EU** - Non European Countries:
 - Strictly implemented for use as country code attributes.
 - Not intended to be used for Publication, Subscription and Registration (e.g., Target Market)

36.1.2 001 – Global Market & D_A – Development Assistance

When using these target markets for Item Publication and Subscription, the trading partner should be aware of some limitations of this methodology.

- Local Data
 - This Target Market does not support the exchange of localised data Examples:
 - Tax, Duty, Levy Information
 - Regulatory Information
 - Import Classification

- A Recipient should subscribe to the local Target Market they are seeking this type of data from.
- Global Data
 - This Target Market can be used with tradeItemTradeChannelCode to help drive a global business context for a recipient to operate in
 - Enablement of a Global Item record, multi-language support across many markets globally when GDS is not supported in some markets The primary language is based on global implementation consideration, instead of local market languages.
 - When data needs are outside of local Market Data Models, and the needs may not be achieved by subscribing at the Local Target Market.

If a validation is needed for these markets, then a rule should include tradeItemTradeChannelCode to be relevant.

37 Transportation, Dangerous and Hazardous Information

37.1 Introduction

This section deals with guidance around meeting the various global laws and regulations for transportation, dangerous and hazardous information. While it is stressed that it is the sole responsibility of individual companies to both be aware of, and conform to, all local regulations in which the company is operating, to fulfil some of the requirements it is necessary to share information about good in transport, dangerous goods and hazardous materials. Such information is defined by local legislation and, in some cases, can be shared via GDSN and this section aims to provide guidance on how this can be done by exchanging data between GDSN Data Pools.

- **Important:** Regulations will change over time and this guidance is not intended to be either comprehensive or provide any legal guarantee that the regulation is being met

Please see local legal jurisdiction but the following legal documents are of note:

- Regulation (EU) No 1272/2008 on classification, labelling and packaging of substances and mixtures:
 - <http://eur-lex.europa.eu/LexUriServ/LexUriServ.do?uri=OJ:L:2008:353:0001:1355:en:PDF>
- ADR 2017 – European Agreement Concerning the International Carriage of Dangerous Goods by Road:
 - <https://www.unece.org/trans/danger/publi/adr/adr2017/17contentse0.html>
 - References to chapters of ADR in this document are to the version ADR applicable from 1 January 2017, Volume I, ISBN 978-92-1-139156-5, referred as “ADR 2017” hereafter.
- United Nations (UN) Recommendations on the Transport of Dangerous Goods – Model Regulations
 - <http://www.unece.org/trans/danger/danger.html>

GS1 standards, services and solutions can help companies to comply with requirements concerning communication of product data and provisions concerning both logistics and distance selling and to achieve data of good quality.

- **Important:** There may be extra requirements coming from local legislation which are out of scope of this guideline.

This document aims at providing a harmonized way of using GDSN to exchange information to comply with the legislation between trading partners. The objective here is to specify the data to be exchanged between data pools. Each data pool is responsible for mapping the right message. The

way the information will be displayed on the website or elsewhere by the user of the data is outside the scope of these recommendations.

- **Important:** This guidance is a technical document and is not intended to provide a legal interpretation of local legislation, the ultimate official interpretation of which is the exclusive reserve of the judicial powers.

37.1.1 Acronyms used

- GDSN, Global Data Synchronisation Network (www.gs1.org/gdsn)
- GHS, Globally Harmonized System of Classification and Labelling of Chemicals (<https://www.unece.org/trans/danger/publi/ghs/pictograms.html>)
- ADR, European Agreement concerning the International Carriage of Dangerous Goods by Road (http://www.unece.org/trans/danger/publi/adr/adr_e.html)
 - "ADR" is derived from the French name for the treaty: **A**ccord européen relatif au transport international des marchandises **D**angereuses par **R**oute

37.2 Safety Data Sheets

This guideline provides information about how to exchange the information about dangerous goods in a structured way via GDSN attributes. This information may also be found in traditional safety data sheet. In case data provider is not able to provide information about dangerous goods in a structured way, trading partners may agree to receive safety data sheet containing required data. Data providers shall check local implementation guideline for detailed requirements.

37.3 Attributes description

Description of GDSN attributes used to exchange information required by legislation related to dangerous goods, for example ADR and GHS.

All relevant attributes should be declared in all applicable languages in the target market. If some particulars do not apply to some products, corresponding attributes should not be populated.

- **Important:** Regional, national or local law will always take precedence over this guideline.

37.3.1 GHS (Globally Harmonized System) of Classification and Labelling of Chemicals

37.3.1.1 GHS signal words

- **GDSN name:** gHSSignalWordsCode
- **GDSN module:** SafetyDataSheetModule
- **GDSN definition:** Words such as "Danger" or "Warning" used to emphasize hazards and indicate the relative level of severity of the hazard.
For GHS these are assigned to a GHS hazard class and category. Some lower level hazard categories do not use signal words.
- **Instruction:** Provide signal words as they appear on the label of a substance or mixture classified as hazardous. Content of such label is defined in Article 17 of the EU Reg. 1272/2008.
- **Legislation:** EU Regulation 1272/2008 on classification, labelling and packaging of substances and mixtures (EU Reg. 1272/2008).
- **Remark:** Signal words are defined in Article 20 of the EU Reg. 1272/2008.
- **Example:** "Danger"; "Warning"

37.3.1.2 GHS pictogram

- **GDSN name:** gHSSymbolDescriptionCode
- **GDSN module:** SafetyDataSheetModule
- **GDSN definition:** environmental hazard information, assigned to a hazard class and category for example GHS.

Pictograms include the harmonized hazard symbols plus other graphic elements, such as borders, background patterns or colours that are intended to convey specific information.

Examples of all the pictograms and downloadable files for GHS can be accessed on the UN website for the GHS.

- **Instruction:** Provide codes representing hazard pictograms as they appear on the label of a substance or mixture classified as hazardous. Content of such label is defined in Article 17 of the EU Reg. 1272/2008.
- **Legislation:** EU Regulation 1272/2008 on classification, labelling and packaging of substances and mixtures (EU Reg. 1272/2008).
- **Remark:** Hazard pictograms are defined in Article 19 of the EU Reg. 1272/2008. Please note there is also an AVP gHSSymbolCode that can be used to exchange information about these pictograms. Unlike gHSSymbolDescriptionCode, gHSSymbolCode uses the same codes as stated in EU Regulation 1272/2008 Annex V, part 1. Please refer to target market specific implementation guidance to see which of the two attributes is required. Mapping between GHS pictograms and both GDSN attributes code lists is available in section [37.4.1](#).
- **Example:** 'CORROSION'; 'SKULL_AND_CROSSBONES'

37.3.1.3 GHS hazard statements code

- **GDSN name:** hazardStatementsCode
- **GDSN module:** SafetyDataSheetModule
- **GDSN definition:** Standard phrases assigned to a hazard class and category that describe the nature of the hazard for example H200.
- **Instruction:** Provide codes representing hazard statements as they appear on the label of a substance or mixture classified as hazardous. Content of such label is defined in Article 17 of the EU Reg. 1272/2008.
- **Legislation:** EU Regulation 1272/2008 on classification, labelling and packaging of substances and mixtures (EU Reg. 1272/2008). Hazard statements are defined in Article 21 of the EU Reg. 1272/2008 and listed in its Annex III.
- **Remark:** GDSN does not define global code list for this attribute. General recommendation for creating these codes is to concatenate letters and numbers used to identify these statements. For example "H 370" into 'H370' or "EUH 006" into 'EUH006'. Please follow official code lists as they are defined by respective user communities (target markets).
- **Example:** 'H370'; 'EUH006'

37.3.1.4 GHS hazard statements

- **GDSN name:** hazardStatementsDescription
- **GDSN module:** SafetyDataSheetModule
- **GDSN definition:** A description of standard phrases assigned to a hazard class and category that describe the nature of the hazard.
- **Instruction:** Provide exact wording of hazard statements as they appear on the label of a substance or mixture classified as hazardous. Content of such label is defined in Article 17 of the EU Reg. 1272/2008.
 - The hazard statements should be the same as on the label of the item. But sometimes they differ from the Safety Data Sheet which is the official legal document.

- **Legislation:** EU Regulation 1272/2008 on classification, labelling and packaging of substances and mixtures (EU Reg. 1272/2008). Hazard statements are defined in Article 21 of the EU Reg. 1272/2008 and listed in its Annex III (in all official EU languages).
- **Remark:** Provide both fixed part of the statement and additional variable information that can be different for different substances if available. In the following example of H370 statement, variable information is marked by <>: Causes damage to organs <or state all organs affected, if known> <state route of exposure if it is conclusively proven that no other routes of exposure cause the hazard>. Please also note some other implementations are known where only variable information without the fixed part of the statement shall be provided. Please refer to respective target market's guidance when needed.
- **Example:** "Unstable explosives."; "Toxic in contact with skin."; "Causes damage to organs (kidneys) (Inhalation)."

37.3.1.5 GHS precautionary statements code

- **GDSN name:** precautionaryStatementsCode
- **GDSN module:** SafetyDataSheetModule
- **GDSN definition:** Measures listed on a hazardous label to minimize or prevent adverse effects.
For GHS, the precautionary statements have been linked to each GHS hazard statement and type of hazard. Precautionary statements for GHS cover prevention, response in cases of accidental spillage or exposure, storage, and disposal.
- **Instruction:** Provide codes representing precautionary statements as they appear on the label of a substance or mixture classified as hazardous. Content of such label is defined in Article 17 of the EU Reg. 1272/2008.
- **Legislation:** EU Regulation 1272/2008 on classification, labelling and packaging of substances and mixtures (EU Reg. 1272/2008). Precautionary statements are defined in Article 22 of the EU Reg. 1272/2008 and listed in its Annex IV.
- **Remark:** GDSN does not define global code list for this attribute. General recommendation for creating these codes is to concatenate letters and numbers used to identify these statements. For example "P201" into 'P201' or "P403 + P233" into 'P403+P233'.
- **Example:** 'P201'; 'P403+P233'

37.3.1.6 GHS precautionary statements

- **GDSN name:** precautionaryStatementsDescription
- **GDSN module:** SafetyDataSheetModule
- **GDSN definition:** A description of the measures listed on a hazardous label to minimize or prevent adverse effects.
- **Instruction:**
- **Legislation:** EU Regulation 1272/2008 on classification, labelling and packaging of substances and mixtures (EU Reg. 1272/2008). Precautionary statements are defined in Article 22 of the EU Reg. 1272/2008 and listed in its Annex IV (in all official EU languages).
- **Remark:** Provide both fixed part of the statement and additional variable information that can be different for different substances if available. In the following example of P321 statement, variable information is marked by (): Specific treatment (*see ... on this label*). Please also note some other implementations are known where only variable information without the fixed part of the statement shall be provided. Please refer to respective target market's guidance when needed.
- **Example:** "Obtain special instructions before use."; "Store in a well-ventilated place. Keep container tightly closed."; "Specific treatment (see supplemental instructions on the administration of antidotes on this label)."

37.3.2 ADR

- **Note:** ADR" is derived from the French name for the treaty: **A**ccord européen relatif au transport international des marchandises **D**angereuses par **R**out

37.3.2.1 ADR dangerous goods limited quantities code

- **GDSN name:** aDRDangerousGoodsLimitedQuantitiesCode
- **GDSN module:** TransportationHazardousClassificationModule
- **GDSN definition:** A code defined by RID (Regulations concerning the International Carriage of Dangerous Goods by Rail) and ADR (Accord Européen Relatif au Transport International des Marchandises Dangereuses par Route) specifying whether a dangerous good can be packaged in small quantities providing they are packaged and labelled in accordance with certain requirements.
- **Instruction:** Provide information on whether trade item is packed in limited quantities as defined in chapter 3.4 of the ADR 2017. Such trade items are not subject to many provisions of ADR and therefore less information about such trade items can be provided. Please follow rules defined in ADR.
- **Legislation:** ADR 2017, chapter 3.4 – DANGEROUS GOODS PACKED IN LIMITED QUANTITIES
- **Remark:** GDSN does not define global code list for this attribute. Following three codes are recommended:
 - NOT_POSSIBLE = no (trade item does not meet provisions of ADR for dangerous goods packed in limited quantities),
 - POSSIBLE = possible but not used (trade item meets provisions of ADR for dangerous goods packed in limited quantities, but they are not used),
 - USED = possible and used (trade item meets provisions of ADR for dangerous goods packed in limited quantities and they are used).
- **Example:** 'NOT_POSSIBLE'; 'POSSIBLE'

37.3.2.2 ADR tunnel restriction code

- **GDSN name:** aDRTunnelRestrictionCode
- **GDSN module:** TransportationHazardousClassificationModule
- **GDSN definition:** The ADR Tunnel Restriction Code is a code defined in ADR Chapter 8.6, which categorizes road tunnels into categories A to E. Adequate traffic signs regulate the transit of vehicles with dangerous goods. The tunnel restriction code (e.g. E) has to be stated within the transport papers. Trading Partners should look to the specific ADR documentation for current applicable code list values.
- **Instruction:** Provide the tunnel restriction code of the whole load according to ADR 2017, Chapter 8.6 which defines in which tunnel category this dangerous good is allowed to be transported.
- **Legislation:** ADR 2017, Chapter 8.6.4 – Restrictions for the passage of transport units carrying dangerous goods through tunnels
- **Remark:** ADR recognizes 2 types of categorization for tunnel passage restrictions. The first one, which is defined in ADR 2017, Chapter 1.9.5, provides a categorization of tunnels (A to E). The other one provides a categorization of the whole load which is being transported through the tunnel. This categorization basically says in which category of tunnel (A to E) this particular dangerous good is allowed to be transported. This is defined in ADR 2017, Chapter 8.6. In case of this attribute, information providers are asked to select the tunnel restriction code of the whole load according to ADR 2017, Chapter 8.6.4.

This attribute is defined as String in GDSN but often implemented as a code list. If implemented as a code list, it is recommended to use codes identifying tunnel restrictions as listed in Chapter

8.6.4 of ADR 2017. Please see [37.4.2](#) for list of these codes in ADR 2017. Please follow local implementation guidelines for exact details.

- **Example:** 'B/D'; 'C'.

37.3.2.3 ADR class of dangerous goods

- **GDSN name:** classOfDangerousGoods
- **GDSN module:** TransportationHazardousClassificationModule
- **GDSN definition:** The dangerous goods classification of the trade item. Dangerous classes explain in general terms the hazardous nature and properties of the goods and serves to classify them together in terms of their most significant risk. Recommend to use codes listed in the edition of the UN Recommendations on the Transport of Dangerous Goods was published in 2009.
- **Instruction:** Provide the class of dangerous goods according to ADR 2017, Chapter 2.1.1.1. Classes and their codes in this document are equal to the classes and codes in the 16th edition of the UN Recommendations on the Transport of Dangerous Goods (published in 2009).
- **Legislation:** ADR 2017, Chapter 2.1 – GENERAL PROVISIONS
- **Remark:** Classes which are used in this code list (classOfDangerousGoods) are defined in ADR 2017, Chapter 2.1.1.1.

In Europe, this attribute is often used as a code list to exchange classes of dangerous goods according to ADR. Use of valid codes, in case ADR information is being exchanged, is enforced by GDSN global validation rule No 437.

Some classes are divided in subdivisions or allow further means of providing more details about respective dangerous goods category. Such information, however, are not to be exchanged via classOfDangerousGoods attribute. Attribute [ADR Dangerous goods classification code](#) shall be used in most of such scenarios.

This attribute is defined as String in GDSN but often implemented as a code list. If implemented as a code list, codes identifying ADR class of dangerous goods are listed in Chapter 2.1 of ADR 2017. Please see examples. Please follow local implementation guidelines for exact details.

- **Example:** '1'; '4.1'

The GDSN codes of these classes are available in chapter [ADR Class of Dangerous Goods](#).

37.3.2.4 ADR Dangerous goods classification code

- **GDSN name:** dangerousGoodsClassificationCode
- **GDSN module:** TransportationHazardousClassificationModule
- **GDSN definition:** A classification code of the trade item (dangerous goods) for transport by road and rail for example ADR/RID. It indicates the dangerous characteristics respectively the subsections of the trade item within a given classification.
- **Instruction:** Provide the subclass of classOfDangerousGoods.
- **Legislation:** ADR 2017, Chapter 2.2 – CLASS SPECIFIC PROVISIONS
- **Remark:** In Europe, this attribute is used to provide more details about dangerous goods category on top of basic classification for which attribute [ADR Class of Dangerous Goods](#) is used. There are no globally defined code lists or validation rules that determine which values are valid. The exact code can differ market to market. Please refer to documentation of respective target markets for more guidance.

This attribute is defined as String in GDSN but often implemented as a code list. If implemented as a code list, codes identifying dangerous goods classification are listed in Chapter 2.1 of ADR 2017. Please see examples. Please follow local implementation guidelines for exact details.

- **Example:** Examples of how to use this code list can be found in annex [Dangerous Goods Classification code usage EXAMPLE](#).

37.3.2.5 ADR Dangerous goods packing group

- **GDSN name:** dangerousGoodsPackingGroup
- **GDSN module:** TransportationHazardousClassificationModule
- **GDSN definition:** Identifies the degree of risk these dangerous goods present during transport according to IATA/IMDG/ADR/RID regulations.
- **Instruction:** Provide the packing group of dangerous goods according to ADR.
- **Legislation:** ADR 2017, Chapter 2.2 – CLASS SPECIFIC PROVISIONS
- **Remark:** Dangerous goods are assigned into 3 packing groups according to the degree of danger they present. These packing groups are:
 - I: high danger (sometimes stated as “great danger”)
 - II: medium danger
 - III: low danger (sometimes sated as “minor danger”)

The division into packing groups depends on the class of substance (see [ADR Class of Dangerous Goods](#) attribute). The division criteria for different classes of dangerous goods are defined in ADR 2017, Chapter 2.2. For most of dangerous goods which are being transported, the packing group is defined in ADR 2017, Chapter 3.2.1: Table A – DANGEROUS GOODS LIST.

This attribute is defined as String in GDSN but often implemented as a code list. If implemented as a code list, codes identifying dangerous goods packing group are listed in Chapter 2.2 of ADR 2017. Please see examples. Please follow local implementation guidelines for exact details.
- **Example:** 'I'; 'II'; 'III'

37.3.2.6 Dangerous goods regulation code

- **GDSN name:** dangerousGoodsRegulationCode
- **GDSN module:** TransportationHazardousClassificationModule
- **GDSN definition:** An indication of the classification system(s) of dangerous goods and/or the Agency(ies) responsible for it.
- **Instruction:** Please follow respective target market’s implementation guide when populating this attribute.
- **Legislation:**
- **Remark:** Code lists used usually differ market by market.
- **Example:**

37.3.2.7 Flash point temperature

- **GDSN name:** flashPointTemperature
- GDSN module:** SafetyDataSheetModule
- **GDSN definition:** The lowest temperature at which a substance gives off a sufficient vapor to support combustion. This uses a measurement consisting of a unit of measure and value.
- **Instruction:** Provide the flash point temperature in Celsius Degrees.
- **Legislation:**
- **Remark:** There is a difference between flash point and ignition temperature. In case of flash point temperature there must be a source to ignite the gas which vaporizes from the substance at this temperature. When it comes to ignition temperature the gas ignites at this temperature without a source. The ignition temperature is thus higher than the flash point temperature. Information providers shall provide the flash point temperature in this attribute. Additional modifiers may be required including:
 - flashPointTestMethodCode

- flashPointDescriptor
- flashPointTemperatureLowerValue
- flashPointTemperatureMeasurementPrecision
- flashPointTemperatureUpperValue
- **Example:** if the lowest temperature of the substance which is required to ignite the vaporized gas is 27 Degrees Celsius, fill in "27". In the case where a temperature range is required provide both flashPointTemperatureLowerValue and flashPointTemperatureUpperValue

37.3.2.7.1 Flash point temperature

- **GDSN name:** flashPointTemperature
- **GDSN module:** TransportationHazardousClassificationModule
- **GDSN definition:** The minimum temperature at which a liquid gives off a vapour within a vessel in sufficient concentration to form an ignitable mixture with air near the surface of a liquid.
- **Instruction:** Provide the flash point temperature in Celsius Degrees.
- **Legislation:**
- **Remark:** There is a difference between flash point and ignition temperature. In case of flash point temperature there must be a source to ignite the gas which vaporizes from the substance at this temperature. When it comes to ignition temperature the gas ignites at this temperature without a source. The ignition temperature is thus higher than the flash point temperature. Information providers shall provide the flash point temperature in this attribute.
- **Example:** if the lowest temperature of the substance which is required to ignite the vaporized gas is 27 Degrees Celsius, fill in "27".

37.3.2.8 Hazardous material additional information

- **GDSN name:** hazardousMaterialAdditionalInformation
- **GDSN module:** TransportationHazardousClassificationModule
- **GDSN definition:** Any regulatory information required that is not specifically identified by another field.
- **Instruction:** If applicable, provide more information about the dangerous good which could not be provided in other attributes or code lists.
- **Legislation:**
- **Remark:** It can be any information which is required by legislation and for which there are no attributes or code lists in GDSN. It can be used when the item is not classified as a Hazardous Material but additional information is required.
- **Example:** HazardousMaterialAdditionalInformation attribute is used when the item is not classified as a hazardous but additional information is required:
 - **Example of the additional information:** 'Extremely flammable, containing 7,1 p-% by volume of flammable substances. Store below 50°C', 'No hazardous classifications according for transport regulations'

37.3.2.9 Dangerous goods shipping name

- **GDSN name:** dangerousGoodsShippingName
- **GDSN module:** TransportationHazardousClassificationModule
- **GDSN definition:** Shipping name of the trade item (dangerous goods). The recognized agencies (see dangerousGoodsRegulationsCodes), in their regulations, provide a list of all acceptable proper shipping names.

- **Instruction:** Provide a dangerous good shipping name according to ADR 2017, Chapter 3.1.2.
- **Legislation:** ADR 2017, Chapter 3.1.2 – Proper shipping name
ADR 2017, Chapter 3.2.1 - Table A: Dangerous Goods List, column 2 “Name and description”.

- **Remark:** The shipping name is a name which most accurately describes the dangerous goods. More information about how the shipping name should be legally provided can be found in ADR 2017, Chapter 3.1.2.

In most cases, the shipping name equals the technical name however in some cases this may not be quite true. This happens if the shipping name is generic or not otherwise specified (NOS).

If the shipping name for a given dangerous goods is generic or “not otherwise specified” (NOS or N.O.S.), it should be supplemented with the technical name of the goods in brackets in cases where special provision 274 or 318 is applicable (see ADR 2017, Table A: Dangerous Goods List, column 6).

The shipping name of the particular substance can be found in ADR 2017, Table A: Dangerous Goods List.

- **Example:** 'NITROHYDROCHLORIC ACID' – here the shipping name equals the technical name and thus there is no other information in brackets;
'PESTICIDE LIQUID, TOXIC, N.O.S. (drazoxolon)' – here the shipping name does not equal the technical name because it is generic and not otherwise specified. The term in brackets is the technical name of the goods.

37.3.2.10 Dangerous goods special provisions

- **GDSN name:** dangerousGoodsSpecialProvisions
- **GDSN module:** TransportationHazardousClassificationModule
- **GDSN definition:** A numeric code of special regulations to be met regarding a Dangerous Goods Classification Regulation. For example ADR 2005 provides additional information for identifying the substances or items (s. 3.2.1 ADR 2005). Special provisions can include transport restrictions, exemptions from regulation, explanations on the classifying of certain forms of the dangerous goods in question as well as additional marking and labelling requirements.
- **Instruction:** Provide the dangerous goods special provisions according to ADR 2017, Chapter 3.3.
- **Legislation:** ADR 2017, Chapter 3.3 – SPECIAL PROVISIONS APPLICABLE TO CERTAIN ARTICLES OR SUBSTANCES
- **Remark:** This attribute is defined as String in GDSN but often implemented as a code list. If implemented as a code list, numbers identifying special provisions are listed in Chapter 3.3 of ADR 2017. Please see examples. Please follow local implementation guidelines for exact details.
- **Example:** An example of how to use this attribute can be found in [Dangerous Goods Classification code usage EXAMPLE](#).

37.3.2.11 Transport category code

- **GDSN name:** dangerousGoodsTransportCategoryCode
- **GDSN module:** TransportationHazardousClassificationModule
- **GDSN definition:** Trade items classified as dangerous goods are divided into transport categories for the purpose of calculating what quantity of dangerous goods is allowed to be transported on the same transport unit under specific exemption rules.
- **Instruction:** Provide the transport category code.
- **Legislation:** ADR 2017, Chapter 1.1.3.6 – Exemptions related to quantities carried per transport unit.

- **Remark:** Dangerous goods are assigned to categories 0, 1, 2, 3, 4 according to ADR 2017, Chapter 1.1.3.6. These categories are transport category codes. The division of particular substances into these categories can be found in ADR 2017, Chapter 3.2.1 – Table A: Dangerous Goods List, column 15.
- **Example:** '3'; '0'

37.3.2.12 United Nations dangerous goods number

- **GDSN name:** unitedNationsDangerousGoodsNumber
- **GDSN module:** TransportationHazardousClassificationModule
- **GDSN definition:** The four-digit number assigned by the United Nations Committee of Experts on the Transport of Dangerous Goods to classify a substance or a particular groups of substances. Abbreviation: UNDG Number.
- **Instruction:** Provide a 4-digit United Nations Dangerous Goods number for the given substance.
- **Legislation:** ADR 2017, Chapter 2.1 – GENERAL PROVISIONS
ADR 2017, Chapter 3.2.1 – Table A: Dangerous Goods List, column 1.
- **Remark:** The UN number is a 4-digit number which reflects the technical name of goods. The UN number of a particular substance can be found in ADR 2017, Chapter 3.2.1 – Table A: Dangerous Goods List, column 1.

This attribute is defined as String in GDSN but often implemented as a code list. If implemented as a code list, codes identifying United Nations dangerous goods number are listed in Chapter 3.2 – TABLE A DANGEROUS GOODS LIST of ADR 2017. Please see examples. Please follow local implementation guidelines for exact details.

- **Example:** An example of how to use this attribute can be found in [United Nations dangerous goods number usage EXAMPLE](#).

37.3.2.13 Dangerous goods technical name

- **GDSN name:** dangerousGoodsTechnicalName
- **GDSN module:** TransportationHazardousClassificationModule
- **GDSN definition:** Provides the dangerous goods technical information:
 - Proper shipping name is the standard technical name to describe the hazard properties and the composition of dangerous goods.
- **Instruction:** Provide technical name of the dangerous goods: technical name is always needed in case shipping name is given.

Legislation: ADR 2017, Chapter 3.2.1 – Table A: Dangerous Goods List, column 2.

- **Remark:** The proper shipping name (aka UN description), which is the description linked to the UN number, can be found in ADR 2017, Chapter 3.2.1 – Table A: Dangerous Goods List, column 2. There is also the technical name that needs to be supplemented to N.O.S. dangerous goods. This can be found in the Safety Data Sheet. Trade names shall not be used for this purpose.

For more information refer to [Dangerous goods shipping name](#) in this document as there can be a relation between dangerous goods technical name and shipping name.

- **Example:** 'Pentolite'

37.3.2.14 Dangerous hazardous label number

- **GDSN name:** dangerousHazardousLabelNumber
- **GDSN module:** TransportationHazardousClassificationModule

- **GDSN definition:** A visible number indicating the specific risk and thus the required precautions associated with a dangerous or hazardous good for example, the indication of the hazardous label number according to chapter 3.2, table A of the ADR.
- **Instruction:** Provide the dangerous hazardous label number of the dangerous goods.
- **Legislation:** ADR 2017, Chapter 2.1 – GENERAL PROVISIONS
ADR 2017, Chapter 3.2.1 – Table A: Dangerous Goods List, column 5.
- **Remark:** The dangerous hazardous label number indicates the number of class of the dangerous goods. The numbers for each class of dangerous goods can be found in ADR 2017, Chapter 2.1. The label numbers for particular substances can be found in ADR 2017, Chapter 3.2.1 – Table A: Dangerous Goods List, column 5.
- **Example:** An example of how to use this attribute in connection with Dangerous hazardous label sequence number is shown in [Dangerous Hazardous Label Number and Dangerous Hazardous Label Sequence Number usage EXAMPLE](#).

37.3.2.15 Dangerous hazardous label sequence number

- **GDSN name:** dangerousHazardousLabelSequenceNumber
- **GDSN module:** TransportationHazardousClassificationModule
- **GDSN definition:** A sequence number indicating the primacy of one dangerous/hazardous label number over another. For example, a value of 1 would indicate that the associated hazard label number is the primary, 2 = secondary, etc.
- **Instruction:** Provide the dangerous hazardous label sequence number of the dangerous goods.
- **Legislation:** ADR 2017, Chapter 5.2.2 - MARKING AND LABELLING
- **Remark:** The sequence of the label number is very important. It is absolutely necessary for the recipient of the data to differentiate between the main, secondary, tertiary etc. danger.
- **Example:** An example of how to use this attribute in connection with Dangerous hazardous label number is shown in [Dangerous Hazardous Label Number and Dangerous Hazardous Label Sequence Number usage EXAMPLE](#).

37.3.2.16 Dangerous Goods Hazardous Code

- **GDSN name:** dangerousGoodsHazardousCode
- **GDSN module:** TransportationHazardousClassificationModule
- **GDSN definition:** Dangerous goods hazard ID number, which must be applied to the vehicle, when transporting this trade item (dangerous good) by road or rail, to inform the police, the fire brigade and others in case of an accident about the kind of danger caused by the cargo.
- **Instruction:** Provide the hazard identification number.
- **Legislation:** ADR 2017, Chapter 5.3.2.3 – Meaning of hazard identification numbers
- **Remark:** The hazard identification number (Kemler code) consists of 2 or 3 numbers which indicate the hazard according to table in ADR 2017, Chapter 5.3.2.3. It is used for transport purposes and shown on an orange-colored plate together with UN code. The hazard identification code is always inscribed in the upper part of the plate while the UN number in the lower part.
- This field only applies to tank transport, not to packaged dangerous goods
- **Example:** An example of how to use this attribute is shown in [Dangerous Goods Hazardous Code usage EXAMPLE](#).

37.3.2.17 Net Mass Of Explosives [kg]







- **GDSN name:** netMassOfExplosives
- **GDSN module:** TransportationHazardousClassificationModule



- **GDSN definition:** The measurement of the net explosive mass of the trade item (dangerous goods) for transport by road and rail according to a dangerous goods classification regulation.
- **Instruction:** Provide the net mass of explosives in kilograms.
- **Legislation:** ADR 2017, Chapter 5.4.1.2.1 – ADDITIONAL OR SPECIAL INFORMATION REQUIRED FOR CERTAIN CLASSES - ADR 5.4.1.2.1 a)
- **Remark:**
Example: `1263: Paint (flammable)/Paint related material (flammable) → 1000 KGM`

37.4 Reference materials and examples

37.4.1 Code lists of GHSSymbolDescriptionCode and gHSSymbolCode

The table below summarises the mapping between the GHS pictograms and the GDSN attributes codes.

gHSSymbolCode (currently an AVP)	GHSSymbolDescriptionCode	Description	Pictogram
GHS05	CORROSION	corrosion	
GHS09	ENVIRONMENT	environment	
GHS07	EXCLAMATION_MARK	exclamation mark	
GHS01	EXPLODING_BOMB	exploding bomb	
GHS02	FLAME	flame	
GHS03	FLAME_OVER_CIRCLE	flame over circle	

gHSSymbolCode (currently an AVP)	GHSSymbolDescriptionCode	Description	Pictogram
GHS04	GAS_CYLINDER	gas cylinder	
GHS08	HEALTH_HAZARD	health hazard	
	NO_PICTOGRAM		
GHS06	SKULL_AND_CROSSBONES	skull and crossbones	
	NOT_APPLICABLE		

37.4.2 ADR tunnel restriction code EXAMPLE

It is recommended to use the codes as they are provided in the first column of Figure 1 below, e.g. 'B', 'B1000C' ...

Figure 37-1 Tunnel restriction code of the whole load, chapter 8.6.4 of ADR 2017

Tunnel restriction code of the whole load	Restriction
B	Passage forbidden through tunnels of category B, C, D and E
B1000C	Carriage where the total net explosive mass per transport unit <ul style="list-style-type: none"> - exceeds 1000 kg: Passage forbidden through tunnels of category B, C, D and E; - does not exceed 1000 kg: Passage forbidden through tunnels of category C, D and E
B/D	Tank carriage: Passage forbidden through tunnels of category B, C, D and E; Other carriage: Passage forbidden through tunnels of category D and E
B/E	Tank carriage: Passage forbidden through tunnels of category B, C, D and E; Other carriage: Passage forbidden through tunnels of category E
C	Passage forbidden through tunnels of category C, D and E
C5000D	Carriage where the total net explosive mass per transport unit <ul style="list-style-type: none"> - exceeds 5000 kg: Passage forbidden through tunnels of category C, D and E; - does not exceed 5000 kg: Passage forbidden through tunnels of category D and E
C/D	Tank carriage: Passage forbidden through tunnels of category C, D and E; Other carriage: Passage forbidden through tunnels of category D and E
C/E	Tank carriage: Passage forbidden through tunnels of category C, D and E; Other carriage: Passage forbidden through tunnels of category E
D	Passage forbidden through tunnels of category D and E
D/E	Bulk or tank carriage: Passage forbidden through tunnels of category D and E; Other carriage: Passage forbidden through tunnels of category E
E	Passage forbidden through tunnels of category E
-	Passage allowed through all tunnels (For UN Nos. 2919 and 3331, see also 8.6.3.1).

37.4.3 ADR Class of Dangerous Goods

GDSN codes for ADR class of dangerous goods:

Code	Name ENG
1	Explosive substances and articles
2	Gases
3	Flammable liquids
4.1	Flammable solids, self-reactive substances and solid desensitized explosives
4.2	Substances liable to spontaneous combustion
4.3	Substances which, in contact with water, emit flammable gases
5.1	Oxidizing substances

Code	Name ENG
5.2	Organic peroxides
6.1	Toxic substances
6.2	Infectious substances
7	Radioactive material
8	Corrosive substances
9	Miscellaneous dangerous substances and articles

37.4.4 Dangerous Goods Classification code usage EXAMPLE

Class 1 Explosive substances and articles

Information about substance's division (*chapter 2.2.1.1.5 of the ADR 2017*) and compatibility group (*chapter 2.2.1.1.6 of the ADR 2017*) is usually provided for Class 1 trade items in `dangerousGoodsClassificationCode`.

For example, dangerous substance for which mass explosion hazard exists (division 1.1) that is primary explosive substance (compatibility group A) could have following code: '1.1A'.

Class 2 Gases

Information about substance's subdivision (*chapter 2.2.2.1.2 of the ADR 2017*) and hazardous properties group (*chapter 2.2.2.1.3 of the ADR 2017*) is usually provided for Class 2 trade items in `dangerousGoodsClassificationCode`.

For example, dissolved gas (subdivision 4) that is toxic and flammable (hazardous group TF) could have following code: '4TF'.

Class 3 Flammable liquids

Information about substance's subdivision (*chapter 2.2.3.1.2 of the ADR 2017*) is usually provided for Class 3 trade items in `dangerousGoodsClassificationCode`.

For example, flammable liquid and toxic pesticide (subdivision FT2) could have following code: 'FT2'.

Class 4.1 Flammable solids, self-reactive substances and solid desensitized explosives

Information about substance's subdivision (*chapter 2.2.41.1.2 of the ADR 2017*) is usually provided for Class 4.1 trade items in `dangerousGoodsClassificationCode`.

For example, self-reactive substances requiring temperature control (subdivision SR2) could have following code: 'SR2'.

Class 4.2 Substances liable to spontaneous combustion

Information about substance's subdivision (*chapter 2.2.42.1.2 of the ADR 2017*) is usually provided for Class 4.2 trade items in `dangerousGoodsClassificationCode`.

For example, oxidizing substances liable to spontaneous combustion (subdivision SO) could have following code: 'SO'.

Class 4.3 Substances which, in contact with water, emit flammable gases

Information about substance's subdivision (*chapter 2.2.43.1.2 of the ADR 2017*) is usually provided for Class 4.3 trade items in `dangerousGoodsClassificationCode`.

For example, liquid substance which, in contact with water, emits flammable gases, toxic (subdivision WT1) could have following code: 'WT1'.

Class 5.1 Oxidizing substances

Information about substance's subdivision (*chapter 2.2.51.1.2 of the ADR 2017*) is usually provided for Class 5.1 trade items in `dangerousGoodsClassificationCode`.

For example, solid corrosive oxidizing substance (subdivision OC2) could have following code: 'OC2'.

Class 5.2 Organic peroxides

Information about substance's subdivision (*chapter 2.2.52.1.2 of the ADR 2017*) is usually provided for Class 5.2 trade items in `dangerousGoodsClassificationCode`.

For example, organic peroxides not requiring temperature control (subdivision P1) could have following code: 'P1'.

Class 6.1 Toxic substances

Information about substance's subdivision (*chapter 2.2.61.1.2* of the *ADR 2017*) is usually provided for Class 6.1 trade items in `dangerousGoodsClassificationCode`.

For example, flammable liquid toxic substances (subdivision TF1) could have following code: 'TF1'.

Class 6.2 Infectious substances

Information about substance's subdivision (*chapter 2.2.62.1.2* of the *ADR 2017*) is usually provided for Class 6.2 trade items in `dangerousGoodsClassificationCode`.

For example, clinical waste (subdivision I3) could have following code: 'I3'.

Class 7 Radioactive material

The *ADR 2017* does not provide any further subdivisions of Class 7.

Class 8 Corrosive substances

Information about substance's subdivision (*chapter 2.2.8.1.2* of the *ADR 2017*) is usually provided for Class 8 trade items in `dangerousGoodsClassificationCode`.

For example, solid self-heating corrosive substances (subdivision CS) could have following code: 'CS'.

Class 9 Miscellaneous dangerous substances and articles

Information about substance's subdivision (*chapter 2.2.9.1.2* of the *ADR 2017*) is usually provided for Class 9 trade items in `dangerousGoodsClassificationCode`.

For example, lithium batteries (subdivision M4) could have following code: 'M4'.

37.4.5 Dangerous goods special provisions usage EXAMPLE

If for example a special provision number 23 is applicable on the given substance according to the *ADR 2017*, Chapter 3.3, then the attribute value should be 23. If the attribute is implemented as a code list, it is recommended to use numbers listed in chapter 3.3.1 as its codes, e.g '16', '23', '32' ...

Figure 37-2 Special provisions according to *ADR 2017*, Chapter 3.3

CHAPTER 3.3

SPECIAL PROVISIONS APPLICABLE TO CERTAIN ARTICLES OR SUBSTANCES

3.3.1 When Column (6) of Table A of Chapter 3.2 indicates that a special provision is relevant to a substance or article, the meaning and requirements of that special provision are as set forth below. Where a special provision includes a requirement for package marking, the provisions of 5.2.1.2 (a) and (b) shall be met. If the required mark is in the form of specific wording indicated in quotation marks, such as "Damaged Lithium Batteries", the size of the mark shall be at least 12 mm, unless otherwise indicated in the special provision or elsewhere in ADR.

16 Samples of new or existing explosive substances or articles may be carried as directed by the competent authorities (see 2.2.1.1.3) for purposes including: testing, classification, research and development, quality control, or as a commercial sample. Explosive samples which are not wetted or desensitized shall be limited to 10 kg in small packages as specified by the competent authorities. Explosive samples which are wetted or desensitized shall be limited to 25 kg.

23 Even though this substance has a flammability hazard, it only exhibits such hazard under extreme fire conditions in confined areas.

32 This substance is not subject to the requirements of ADR when in any other form.

37 This substance is not subject to the requirements of ADR when coated.

37.4.6 United Nations dangerous goods number usage EXAMPLE

If the substance is for example Motor spirit, gasoline or petrol, then the UN code according to ADR 2017, Chapter 3.2, Table A is 1203 and this code will be selected from the code list. The code shall be also showed in the lower part of the orange-coloured plate when transporting the substance.

Figure 37-3 UN number of a given substance according to ADR 2017, Chapter 3.2, Table A

1202	DIESEL FUEL complying with standard EN 590:2013 + AC:2014 or GAS OIL or HEATING OIL, LIGHT with a flash-point as specified in EN 590:2013 + AC:2014	3	F1	III	3	640L 664	5 L	E1	R001 P001 IBC03 LP01 R001		MP19	T2	TP1
1202	GAS OIL or DIESEL FUEL or HEATING OIL, LIGHT (flash-point more than 60 °C and not more than 100 °C)	3	F1	III	3	640M 664	5 L	E1	P001 IBC03 LP01 R001		MP19	T2	TP1
1203	MOTOR SPIRIT or GASOLINE or PETROL	3	F1	II	3	243 534 664	1 L	E2	P001 IBC02 R001	BB2	MP19	T4	TP1
1204	NITROGLYCERIN SOLUTION IN ALCOHOL with not more than 1% nitroglycerin	3	D	II	3	801	1 L	E0	P001 IBC02	TF3	MF1		

Figure 37-4 Orange-coloured plate



37.4.7 Dangerous Hazardous Label Number and Dangerous Hazardous Label Sequence Number usage EXAMPLE



Attribute	Value	Kind of danger	Comment	Label
dangerousHazardousLabel Number	3	Main danger	The first sequence number indicates the main danger.	
dangerousHazardousLabel SequenceNumber	1		The label number 3 means "Flammable liquids".	
dangerousHazardousLabel Number	6.1	Secondary danger	The second sequence number indicates the secondary danger.	
dangerousHazardousLabel SequenceNumber	2		The label number 6.1 means "Toxic substances".	
dangerousHazardousLabel Number	8	Tertiary danger	The third sequence number indicates the tertiary danger.	
dangerousHazardousLabel SequenceNumber	3		The label number 8 means "Corrosive substances".	

Figure 37-5 Class of dangerous goods according to ADR 2017, Chapter 2.1

- 2.1.1.1 The classes of dangerous goods according to ADR are the following:
- Class 1 Explosive substances and articles
 - Class 2 Gases
 - Class 3 Flammable liquids
 - Class 4.1 Flammable solids, self-reactive substances, polymerizing substances and solid desensitized explosives
 - Class 4.2 Substances liable to spontaneous combustion
 - Class 4.3 Substances which, in contact with water, emit flammable gases
 - Class 5.1 Oxidizing substances
 - Class 5.2 Organic peroxides
 - Class 6.1 Toxic substances
 - Class 6.2 Infectious substances
 - Class 7 Radioactive material
 - Class 8 Corrosive substances
 - Class 9 Miscellaneous dangerous substances and articles

37.4.8 Dangerous Goods Hazardous Code usage EXAMPLE

Figure 37-6 Orange-coloured plate

Hazard identification number
(dangerousGoodsHazardousCode)

UN number
(unitedNationsDangerousGoodsNumber)

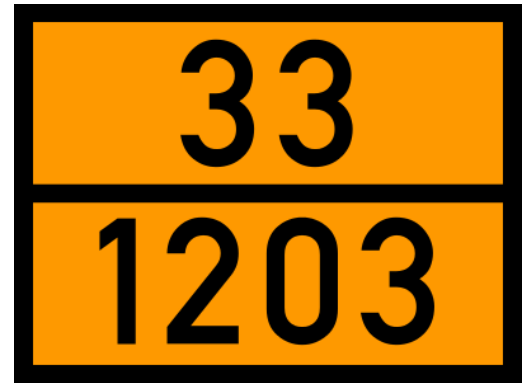

Figure 37-7 Meaning of hazard identification numbers according to ADR 2017, Chapter 5.3.2.3

5.3.2.3 Meaning of hazard identification numbers

5.3.2.3.1 The hazard identification number consists of two or three figures. In general, the figures indicate the following hazards:

- 2 Emission of gas due to pressure or to chemical reaction
- 3 Flammability of liquids (vapours) and gases or self-heating liquid
- 4 Flammability of solids or self-heating solid
- 5 Oxidizing (fire-intensifying) effect
- 6 Toxicity or risk of infection
- 7 Radioactivity
- 8 Corrosivity
- 9 Risk of spontaneous violent reaction

In this example the hazard identification number is 33, which means that the dangerous substance represents highly flammable liquid (flash-point below 23 °C) since 3 means flammability of liquids according to the table above (double three means that the effect is even stronger and hence it is highly flammable liquid). If the code was for instance 368, then it would mean flammable liquid, toxic, corrosive.

38 Hallmarks, Accreditations and Regulatory Labels management

There are different attributes in GDSN that are used for management of labels and accreditations marked on a product's packaging:

- **Note:** these are label marking on a:
 1. **localPackagingMarkedLabelAccreditationCodeReference:** an attribute that can be used for all trading partner specific labels. It is defined as a string but each local GS1 Member Organisation can define a code list for its members to be used locally. This attribute does not have any global management and its values are not included in the GS1 global documentation. However, a GSMP Work Request is required for updating and sharing local codes at the global level that will be introduced in the global attribute (see [Local Code Lists](#) sorted by territory).

2. **packagingMarkedLabelAccreditationCode:**

The code value for this global attribute can be:

- A local label/accreditation: Usable and recognised by trading partners in one country.
- A regional label/accreditation: Usable and recognised in regional area like a continent (Europe, Asia, ...).
- A global label/accreditation: Usable and recognised all over the world by any partner.

Any new GSMP Work Request to update this label codes list requires the submitter to provide evidence of global usage.

Defined as a global code list and all of the values for codes are available in two locations:

- the normative [global data dictionary](#) (make sure to select the last version of the list)
- the informative [Packaging Label Guide Excel Spreadsheet](#) which included more details:
 - **GDS code:** Code that will be used in the trade item description
 - **GDS definition:** Business oriented definition that will help the user of the label/accreditation fully understand the criteria.
 - **Image(s) of the logo:** Typically provided by the organisation that provides the accreditation
 - **Web link:** The URL of the responsible label/accreditation organisation.
 - **Country or region *informative*:** This will help the user of the documentation understand the area where the label or accreditation is used. It can be local (specific country), region (Europe, Asia, ...) or global (for all countries)
 - **Product type *informative*:** This will help the user of the documentation understand what type of product(s) for which the label/accreditation is usable. Example: food, non-food, cosmetics, etc.
 - **Function *informative*:** This will help the user of the documentation understand the function of the label/accreditation. Example: Safety, origin, diet ...

When the local label/accreditation is recognised at the global level, it means that it has been approved under the full GSMP process and integrated into the global attribute

packagingMarkedLabelAccreditationCode

- Sometimes a new label/accreditation may be developed and initially used at a local level and, only when accepted by the market is a GSMP Work Request submitted to make its use global. This is discouraged as a migration plan is required to move from the local to the global attribute. Thus causing unnecessary impact to the local trading community, and can possibly cause duplication between the 2 attributes as soon as the label/accreditation value is available all GDSN users need to send it in the global attribute. In this case, a period of acceptance of the 2 attributes (local and global) will be maintained in the release in which the new label was introduced as a global attribute. The old local label should no longer be used and completely phased out 6 months after the introduction of the new label.

- There is a risk making something local, that another market may put in a work request into GSMP for that local level already defined by a market.
- 1. **regulationTypeCode** and **isPackagingMarkedWithRegulatoryCompliance**: These attributes can be used in combination to declare any regulatory type labelling on a trade item package. There are 2 parts to stating these labels.
 - a. **regulationTypeCode**: Select the code that represents the proper regulation product is labelled in compliance with
 - b. **isPackagingMarkedWithRegulatoryCompliance**: Set this attribute to TRUE.

Examples include:



regulationTypeCode: AEROSOL_REVERSE_EPSILON
isPackagingMarkedWithRegulatoryCompliance: TRUE



regulationTypeCode: ANIMAL_ID_HEALTH_MARK
isPackagingMarkedWithRegulatoryCompliance: TRUE



regulationTypeCode: CE
isPackagingMarkedWithRegulatoryCompliance: TRUE

39 Target consumer age group, introduction

This section deals with the use of target consumer age groups. It contains a common code for each target consumer age group type (e.g., BABY, TEEN ...).

39.1 Why do we need a common range for each code

Each retailer or supplier has its own method to define an age range. For example, "BABY" can be defined as a person that is "0" to "24" months or "29" days to "24" months. The objective of this section is to define a common range for each code associated to each age range.

These codes will be used to describe the target consumer for which the products are intended to be used. For example, "solar cream is intended to be used by baby". Each user of the GS1 standards user may have their own codes that can be mapped to the codes listed below.

39.2 Usable codes for each age range

- **Important:** The content of "Approximate associated age range" in the table below is an example for each code but not a normative statement that covers all target markets and

product types. Each code could imply a different age ranges based on target market or product/industry.

Code	Code definition	Approximate associated age range
NEWBORN	The product is intended to be used by a newborn.	0 to 28 days old
BABY	The product is intended to be used by a baby.	29 days to 2 years old
CHILD	The product is intended to be used by a child.	2 to 11 years old
TEEN	The product is intended to be used by a teen.	11 to 17 years old
ADULT	The product is intended to be used by an adult.	18 to 69 years old
SENIOR	The product is intended to be used by a senior.	70 or more years old
ALL_AGES	The product is intended to be used by all age groups.	All ages
UNCLASSIFIED	The target age of the consumer is unclassified	unclassified

- **Note:** Some products can be used by all consumers because usage does not depend on a specific age range. For these kind of product, business partners will use the code "ALL_AGES". On the other hand, suppliers can have a product for which a specific age range is not defined and can use the code UNCLASSIFIED to inform business partner.

40 Usage of regulation attributes regarding compliance declaration

The regulation class **RegulatoryInformation** allows listing multiple regulation type codes (regulationTypeCode) but only one declaration of compliance (isTradeItemRegulationCompliant).

How do we handle situation when some regulations are compliant and some non-compliant?

We also must take into consideration additional attributes allowing providing additional information per regulation. If they are not used or their values are same for the group of regulations, then first scenario offers simple solution.

RegulatoryInformation class allows using one instance for all regulations compliant and one additional instance for all regulations non-compliant.

By default, if the boolean **isTradeItemRegulationCompliant** is not populated, this means that the product is fully compliant with the indicated regulation.

Differences between values of isTradeItemRegulationCompliant:

- If the supplier declare that the product is compliant with a regulation 'isTradeItemRegulationCompliant = TRUE', he will need to populate all required attributes for this regulation. This will inform the retailer that the product fully conforms to the regulation and can be sold to the end consumer.
- If the supplier declare that the product is not compliant with a regulation 'isTradeItemRegulationCompliant = FALSE', this will inform the retailer that the product does not conform to the regulation and cannot be sold to the end consumer.

- **Note:** Regulatory compliance is required when a product or designation of compliancy is required when publishing to a Target Market. However, an example of 'isTradeItemRegulationCompliant = FALSE' would be when a product is sold to the US market

but is not compliant with a specific regulation of an individual state (e.g., California Regulation Prop 65). The product is available to be sold in the US except California due to not being in compliance with the regulation.

40.1 Scenario 1: Additional regulatory attributes are not used

Example:

We would like to declare compliance for the following regulations. The item is compliant with first three but not with the last one.

- COMPLIANT_WITH_FLAMMABILITY_ACT
- CONSUMER_PRODUCT_SAFETY
- DETERGENTS_SAFETY_REGULATION
- TRACEABILITY_REGULATION

RegulatoryInformation

```
regulationTypeCode = COMPLIANT_WITH_FLAMMABILITY_ACT  
regulationTypeCode = CONSUMER_PRODUCT_SAFETY  
regulationTypeCode = DETERGENTS_SAFETY_REGULATION  
isTradeItemRegulationCompliant = TRUE
```

RegulatoryInformation

```
regulationTypeCode = TRACEABILITY_REGULATION  
isTradeItemRegulationCompliant = FALSE
```

This scenario allows efficient use of this class assuming additional attributes providing additional optional information about the specific regulation are not used:

- regulatoryAct
- regulatoryAgency
- regulationCommunityLevelCode
- regulationRestrictionsAndDescriptors
- regulationRestrictionCommunityIdentifier

40.2 Scenario 2: Additional regulatory attributes are used

In this scenario we need to repeat the whole class per each regulation type so we could communicate additional information per regulation type in addition to compliance declaration.

Example:

RegulatoryInformation

```
regulationTypeCode = COMPLIANT_WITH_FLAMMABILITY_ACT  
regulatoryAgency = ABC  
isTradeItemRegulationCompliant = TRUE
```

RegulatoryInformation

regulationTypeCode = CONSUMER_PRODUCT_SAFETY
regulatoryAgency = XYZ
isTradeItemRegulationCompliant = TRUE

RegulatoryInformation

regulationTypeCode = DETERGENTS_SAFETY_REGULATION
regulatoryAgency = YYY
isTradeItemRegulationCompliant = TRUE

RegulatoryInformation

regulationTypeCode = TRACEABILITY_REGULATION
regulatoryAgency = ABC
isTradeItemRegulationCompliant = FALSE

40.3 Scenario 3: Compliance declaration is not used

In this scenario we could use one instance of the class for multiple regulations. In this scenario we assume that all listed regulations are compliant.

Example:**RegulatoryInformation**

regulationTypeCode = COMPLIANT_WITH_FLAMMABILITY_ACT
regulatoryAgency = ABC

RegulatoryInformation

regulationTypeCode = CONSUMER_PRODUCT_SAFETY
regulatoryAgency = XYZ

RegulatoryInformation

regulationTypeCode = DETERGENTS_SAFETY_REGULATION
regulatoryAgency = YYY

40.4 Scenario 4: Regional regulatory applicability

In this scenario we could list regulations and how they apply to specific region, municipality. They have descriptors and restrictions when selling in local region within a target market.

regulationTypeCode=PROP_65
regulationCommunityLevelCode=PROVENCE_OR_STATE
regulationRestrictionsAndDescriptors=Per California regulation this product contains carcinogenic chemical in small quantity. Not hazardous to health in such quantity.
regulationRestrictionCommunityIdentifier= US-CA

regulationTypeCode=PROP_65
regulationCommunityLevelCode=MUNICIPALITY
regulationRestrictionsAndDescriptors=Per California in Orange County product is Prohibited to sell in
regulationRestrictionCommunityIdentifier= 92859
regulationRestrictionCommunityIdentifier= 92864
regulationRestrictionCommunityIdentifier= 92857

41 Nutritional Programs

Healthy, nourished populations depend on strong research and education programs in human nutrition. Nutritional Programs aim to deliver community-based nutrition education programs that help individuals, families, and communities make informed choices about food and lifestyles that support their physiological health, economic, and social well-being. The programs also provide policymakers with the knowledge to make appropriate policies for our citizens.

41.1 Introduction to Nutri-Score

The French law on the modernisation of our health system of 26 January 2016 enshrined in law the possibility of recommending a system of nutritional labelling to facilitate the consumer's choice of purchase, with regards to the nutritional composition of products. Within this framework, a consultation was conducted with representatives of manufacturers, distributors, consumers, health authorities and scientists to define the modalities for the implementation of this labelling system.

The Nutri-Score logo was designed by "[Santé Publique France](#)", the French national public health agency, at the request of the Directorate General of Health, based on the work of Professor Serge Hercberg's team (University of Paris 13), the expertise of the "anses" (French Agency for Food, Environmental and Occupational Health & Safety) and the High Council of Public Health.

In 2019, the European Consumers' Association (BEUC), in cooperation with seven national consumer protection associations, launched a European Citizens' Initiative in support of the procedure. The European Commission should be obliged to deal with a mandatory introduction of the Nutri-Score throughout the European Union.

41.1.1 Nutri-Score, what is it?

A logo that provides information on nutritional quality, simplified and complementary to the mandatory nutritional declaration set by regulations such as REGULATION (EU) No 1169/2011 for Europe. In particular, it facilitates the distinction between similar foods. It is based on a scale of five colours: from dark green, light green, yellow, orange to red, and associated with letters from A to E to optimize its accessibility and understanding by the consumer:

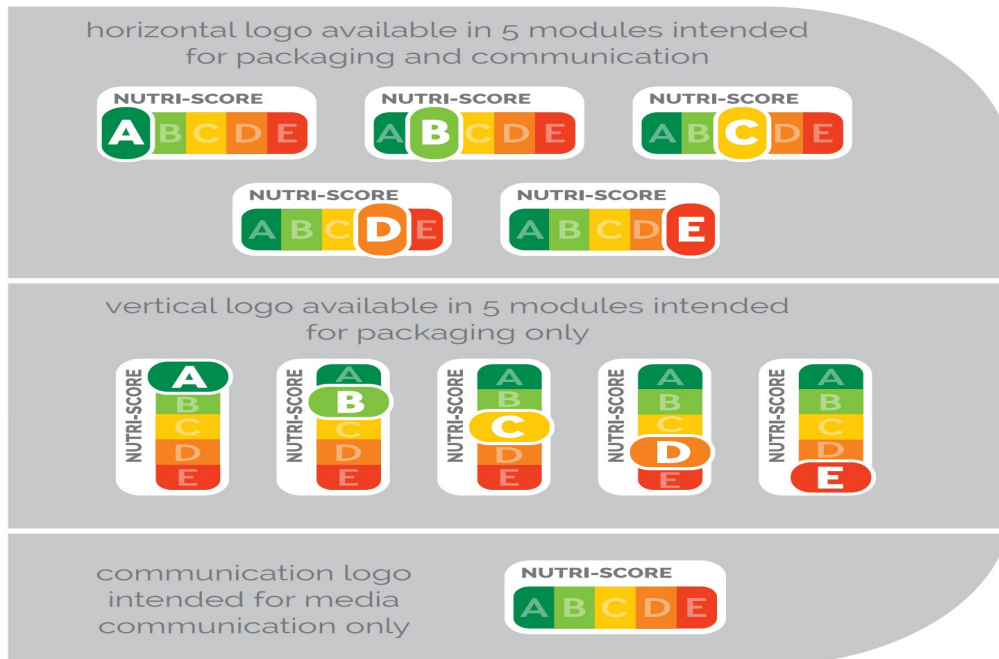

41.1.2 How is it assigned ?

The score considers the nutrients for 100 grams of a food, 100 ml for drinks and soups:

- Favourable, the effect is fibre, protein, fruit, vegetables and nuts (except when highly processed, for example as syrup),
- Unfavourable effects have energy, saturated fatty acids, sugars, salt.

After calculation, the score obtained by a product is assigned a letter and its colour.

41.1.3 Which products are included (affected) ?

The following list of products are concerned by the Nutri-Score information:

- All processed foods, except for herbs, teas, coffees, yeasts, ...
- All drinks, except alcoholic beverages.

Please note that products whose largest face has a surface area of less than 25 cm² are exempt.

41.1.4 Issuance of the trademark

The Nutri-score is a trademark that cannot be used on the packaging without registration:

- For brands marketed on French territory (plus other countries of the European Union): any eligible person wishing to use the Nutri-Score brand must notify the French national public health agency of their intention by registering on the site: https://www.demarches-simplifiees.fr/commencer/enregistrement_nutri-score.
- For brands marketed exclusively outside of France: any eligible person wishing to use the Nutri-Score brand must notify Nutri-Score of their intention to the French national public health agency by registering on the website: <https://www.demarches-simplifiees.fr/commencer/registration-for-brands-distributed-abroad-only>.

This recording includes:

- The identification of the applicant and its activity
- Details by brand, of the product segment concerned by the use of the Brand Name

- The applicant's commitment to respect the rules of use

The files allowing the use of the trademark will be transmitted electronically to the Operator by the French national public health agency, in acknowledgement of receipt of the registration.

41.1.5 Populating attributes for Nutri-Score in GDSN

This section deals with the usage of attributes related to Nutri-Score information. In GDSN, there are five attributes that can be used to describe the Nutri-score information:

- **nutritionalProgramCode:** Identifies the type of program designed to encourage people to eat a certain way. For the Nutri-Score, this attribute will be populated with code **8** (= Nutri-Score).
- **nutritionalScore:** Identifies the score points or ratings, associated with a nutritional program. If nutritionalProgramCode equals **8** (= Nutri-Score), valid ratings (= classes) in nutritionalScore are **A, B, C, D** and **E**. If a product, such as tea, is exempt of Nutri-Score the value **EXEMPT** can be populated to inform trading partners.
- **nutritionalValue:** Indicates the exact value of the score points or ratings, associated with a nutritional program between -14 and +40 for Nutri-Score. The lower the Nutri-Score, the higher the nutritional quality of a food. In fact, while the classes A to E are based on minimum and maximum range values, this attribute can be used to provide the exact value for the Nutri-Score based on the calculation.
- **nutritionalProgramIngredientTypeCode:** Allows to identify the groups of main ingredients contained in the product to better highlight them for the consumer. For the Nutri-Score, the code **FRUITS_VEGETABLES_LEGUMES_AND_NUTS** can be used to identify the quantity of fruits, vegetables, legumes and nuts contained in the recipe of the product.
- **nutritionalProgramIngredientMeasurement:** Value and unit of measure associated with the main group of ingredients specified in the attribute nutritionalProgramIngredientTypeCode. For the Nutri-Score, this will be used to provide the percentage of the main group of ingredients contained in the product, e.g. value **80** and measurement unit code **P1** (= Percent).

41.1.6 External additional documentation

Rules of use : <https://www.santepubliquefrance.fr/media/files/02-determinants-de-sante/nutrition-et-activite-physique/nutri-score/reglement-usage-en>

Scientific and technical questions and answers : <https://www.santepubliquefrance.fr/media/files/02-determinants-de-sante/nutrition-et-activite-physique/nutri-score/gr-scientifique-technique-en>

A spreadsheet to calculate the Nutri-Score of your products :

<https://www.santepubliquefrance.fr/media/files/02-determinants-de-sante/nutrition-et-activite-physique/nutri-score/tableur-calcul-nutri-score-en>

42 Guide for Latex attributes

42.1 Introduction

Information about Latex can be shared in a variety of different ways depending on the business need by the supplier.

- **allergenTypeCode** (LX- LATEX) Refers to the presence of latex as listed in the regulations specified in AllergenSpecificationAgency and AllergenSpecificationName.
- **doesTradeItemContainLatex** An indication that the trade item has a positive latex reference on the Trade Item's labelling.
- **doesTradeItemCompositionIncludeLatex** Identifies if any of the trade item's components or pieces contain latex.
- **doesPackagingMaterialsContainLatex** Identifies if any of the trade item's packaging contains latex.

42.1.1 Latex as Allergen - allergenTypeCode

Natural Latex, In Brazil, the latex notification situation is regulated by ANVISA (Agência Nacional de Vigilância Sanitária) Resolution.

In this scenario, you see LATEX in reference as an allergen with information that “may contain”.

This may be caused by food production plants also contain other production concerning latex where cross contamination may occur.



Bis ao Leite 126g



INGREDIENTES

Açúcar, farinha de trigo enriquecida com ferro e ácido fólico, gordura vegetal hidrogenada, gordura vegetal, cacau, soro de leite em pó, massa de cacau, farinha de soja, amendoim, sal, flocos de arroz, óleo vegetal, leite em pó integral, manteiga de cacau, gordura de manteiga desidratada, extrato de malte, vitaminas B1, B2 e B3, emulsificantes lecitina de soja e poliglicerol poliricinoleato, fermento químico bicarbonato de sódio e aromatizante.

ALÉRGICOS: CONTÉM AMENDOIM E DERIVADOS DE LEITE, TRIGO, SOJA E CEVADA. PODE CONTER AMÊNDOA, CASTANHA-DE-CAJÚ, AVELÃ, AVEIA, CENTEIO E LÁTEX NATURAL.

CONTÉM LACTOSE. CONTÉM GLÚTEN.

INFORMAÇÃO NUTRICIONAL

Porção de 30 g (4 1/2 unidades)		%VD*
Valor energético	151 kcal=634 kJ	8
Carboidratos, dos quais:	20g	7
Açúcares	14g	--
Proteínas	1,4g	2
Gorduras Totais	7,4g	13
Gorduras saturadas	4,1g	19
Gordura trans	0g	--
Fibra alimentar	0,8g	3
Sódio	69mg	3

This information exists in a specific area in this label, as defined by ANVISA Resolution in Brazil for foods:

- Foods, ingredients, food additives and technology aids that contain or are consumed by the foods listed in the Annex should generate a statement "Allergic: Contains (common names of foods that cause food allergies)", "Allergic: Contains common values of foods that cause food allergies) "or" Allergics: Contains (common names of foods that cause food allergies) and derivatives, "as appropriate. Where food allergens cannot be cross-contaminated with food allergens, ingredients, food additives or technology, the statement "Allergic: May contain (common names of foods that cause food allergies)" should be labeled. . (RDC 26/2015)

42.1.2 doesTradeItemContainLatex

In Canada:

The guidance for the labelling of Medical Devices indicate in the case of devices containing natural rubber latex, this material should be identified.

- Link: <https://www.canada.ca/en/health-canada/services/drugs-health-products/medical-devices/application-information/guidance-documents/guidance-labelling-medical-devices-including-vitro-diagnostic-devices-appendices.html>

In United States:

- The basic premise of the attribute is to identify what the package label states about latex
- The examples utilize label phrases from FDA Regulations. These phrases are meant as a visual aid for the examples.

- Full FDA regulations in relation to latex labeling can be found at this link:

<http://www.accessdata.fda.gov/scripts/cdrh/cfdocs/cfcfr/CFRSearch.cfm?fr=801.437>

In United Kingdom:

NHS England specify the use of attribute 'Does Trade Item Contain Latex'. The expectancy is that this will trigger a warning at the point of patient use.

42.1.3 doesTradeItemCompositionIncludeLatex

Once confirmed implementation guidance is provided from a country, this shall be updated. To date, no guidance available.

42.1.4 doesPackagingMaterialsContainLatex

In Canada:

The guidance for the labelling of Medical Devices indicate In the case of devices containing natural rubber latex, this material should be identified.

- Link: <https://www.canada.ca/en/health-canada/services/drugs-health-products/medical-devices/application-information/guidance-documents/guidance-labelling-medical-devices-including-vitro-diagnostic-devices-appendices.html>

42.1.5 packagingMarkedFreeFromCode **FREE_FROM_LATEX**

In United States:

- This is currently populated for the FDA GUDID database
- This attribute is in the process of being deprecated in the future and the intention to migrate to

claimTypeCode (nutritionalClaimTypeCode) = FREE_FROM

claimElementCode (nutritionalClaimNutrientElementCode) = LATEX

43 Formatting for Descriptions

This section deals with the usage of attributes that are of data type Description.

There are 5 types of descriptions:

- Descriptions that allow one value per language (Multiple languages allowed).
- Descriptions that allow multiple values per language (Multiple languages allowed).
- Formatted Description that allows one value per language (Multiple languages allowed). In addition, allow a user to alter the visual presentation of their information using rich text styling, and to send information in a defined sequence using sequence numbers.
- Formatted Description that allows multiple values per language (Multiple languages allowed). In addition, allow a user to alter the visual presentation of their information using rich text styling, and to send information in a defined sequence using sequence numbers.
- Description that allows only one value and one language (New attributes created after Major Release 3, do not use this data type).
- Some of the items that will be addressed in this section of the guide are:
 - How do I specify information when an item contains components? Example: a bag of various candy bars and each bar has different information that needs to be expressed in a description type data field.
 - **Note:** The standard supports rendering this information using the Component set of attributes, but many markets have not implemented this functionality.
 - How do I represent a new paragraph?
 - How do I represent a new line?
 - How do I format or style my text?
 - How can I be sure the information I am sending is in the right order?

43.1 Descriptions Single Value per Language (Multiple languages allowed)

- How do I specify information when an item contains components? Example: a bag of various candy bars and each bar has different information that needs to be expressed in a description type data field.
 - **Solution:** It is recommended if you need to separate components in a single description value, some markets have been using a “#” between components. This is not a standard methodology, only a recommendation by some markets. e.g. European countries. (Please contact your GS1 Member Organisation for proper detailed guidance.)
- How do I represent a new paragraph?
 - **Solution:** Use a carriage return. There is no way to create a new paragraph in a single value, only a carriage return.
- How do I represent a new line?
 - **Solution:** Use a carriage return. While there is no way to tell the difference between a paragraph or a new line, most of the time a new line would indicate a new paragraph.
- How do I Highlight (Bold) a word(s)?
 - **Solution:** The word should be shared in UPPER CASE letters to represent a highlighted or bolded word.

43.2 Descriptions Multiple Values per Language (Multiple languages allowed)

- How do I specify information when an item contains components? Example: a bag of various candy bars and each bar has different information that needs to be expressed in a description type data field.
 - **Solution:** It is recommended you create a separate value for each component. Some markets have been using a “#” at the beginning of each new components. This is not a standard methodology, only a recommendation by some markets.
- How do I represent a new paragraph?
 - **Solution:** It is recommended you create a new separate value a new paragraph.
 - **Note:** some markets do not have the ability to have multiple values. Please contact the local GS1 Member Organisation, if there is an issue.
- How do I represent a new line?
 - **Solution:** Use a carriage return.
- How do I Highlight (Bold) a word(s)?
 - **Solution:** The word should be shared in UPPER CASE letters to represent a highlighted or bolded word.

43.3 Formatted Descriptions One Value per Language (Multiple languages allowed)

- How do I use Formatted Description attributes to state that an item contains components? Example: a bag of various candy bars and each bar has different information that needs to be expressed in a description type data field.
 - Do not use the sequenceNumber as it is not useful as only one value per language can be provided.
 - If you are not using the formatting attributes, follow directions in section 43.1
 - **Solution:** Use a BBCode list:

```
[list]
[*] Component 1: Description of Component 1
[*] Component 2: Description of Component 2
[*] Component 3: Description of Component 3
[/list]
```

- How do I represent a new paragraph?

- **Solution:** Use a BBCode double line break:

Some text here. [br][br] This text begins a new paragraph.

- How do I represent a new line?

- **Solution:** Use a BBCode line break:

Some text here. [br] This text begins a new line.

- How do I format or style my text?

- **Solution:** Use appropriate BBCode formatting tags (See “BBCode Syntax” at section [43.6.3](#)):

Some [b]bold text[/b] here.

[br] This text begins a new line.

Some [i>italicized text[/i] here.

A simple list here: [br] [list]

[*] First list item

[*] Second list item

43.4 Formatted Descriptions Multiple Values per Language (Multiple languages allowed)

- The same recommendations apply as in previous section [43.3](#).
- When using Formatted Description, consider carefully whether it is necessary to send multiple values in one and the same language. A goal of the BBCode implementation is to facilitate the provision of all information in one and the same value, e.g., using the [list] tag or line breaks. This will allow systems tasked with handling the information to do so more gracefully.
- `sequenceNumber` may be used in coordination with the `languageCode`. For a given language, `sequenceNumber` informs the recipient of the correct order in which the data should be represented.
 - It is recommended to use the same `sequenceNumber` for each description line and its translated equivalent.
 - This can be used independently of the `formattingPattern`, just to sequence the descriptions.

43.5 Descriptions One Value, One Language

- Follow directions in [43.1](#)

43.6 Formatting Pattern Examples

43.6.1 Formatted Description using BBCode

The standard leverages BBCode to enable styling of trade item information using attributes of data type Formatted Description. BBCode provides a simple framework for text and document formatting that is similar to HTML, but safer for systems to handle.

BBCode offers a more extensive range of formatting tools than is presented in this document. To simply usage and implementation, this document recommends the use of only a subset of BBCode. In principle however, breadth of implementation may be agreed upon between trading partners.

43.6.2 The reason for the design

BBCode is recommended as the means to send styled trade item information using data type Formatted Description, principally for security reasons. Allowing arbitrary HTML code in trade item information exposes systems to risks related to injection attacks, while BBCode carries no such risks. In addition, the BBCode implementation places responsibility for interpretation of styled trade item information on the data recipient, who can choose to what extent it wishes to allow styled information from its data source.

43.6.3 Suggestions for implementing Formatted Description in GUI based systems

As the examples that follow illustrate, Formatted Description leverages the `formattingPattern` XML attribute. Styled trade item information (if the user wishes to provide it) should be stored in `formattingPattern`, while corresponding plain text information should be stored in its parent XML element. See Simple example: String with formatted text elements and Complex example: Styled ingredients list for sample XML representations.

With respect to the content of Formatted Description attributes, it is good practice to provide the same information at attribute level (styled) as at element level (plain text). This can be accomplished by, for example:

- Implementing `formattingPattern` capabilities in an embedded rich text editor in a GUI. If the user chooses to style their information, its plain text equivalent can be generated by stripping all tagging, and then storing the result in the relevant XML element.
- Relying on user to enter plain text information manually, in addition to their styled information. In this scenario, it may be advantageous to expose XML attribute and XML element as distinct entities in a GUI, so that user may enter each separately.

43.6.4 BBCode Syntax

Text formatting

Operation	BBCode tag	Tag must be closed
Bold	[b]	Yes
Italic	[i]	Yes
Underline	[u]	Yes
Font-size	[size={number}]	Yes
Font-color	[color={color}]	Yes

Structural formatting

Operation	BBCode tag	Tag must be closed
Header (level 1)	[h1]	Yes
Header (level 2)	[h2]	Yes
Line break	[br]	No
Align left	[left]	Yes
Align right	[right]	Yes
Align center	[center]	Yes
Unordered list	[list]	Yes
Numbered list	[list=1]	Yes
List item	[*]	No

Other formatting

Operation	BBCode tag	Tag must be closed
Link	[url]{www.url-here.com}	Yes
Named link	[url={www.url-here.com}]{link-name}	Yes

43.6.5 Simple example: String with formatted text elements

- Content:

This string contains a bold substring and a link to a website.

- XML representation:

```
<tradeItemMarketingMessage formattingPattern="This string contains a
[b]bold[/b] substring and a link to a
[url={www.gs1.org}]website[/url].">This string contains a bold substring and
a link to a website.</tradeItemMarketingMessage>
```

43.6.6 Complex example: Styled ingredients list

- Content

- ▣ **5 X Pickled Onion Flavour Baked Corn Snack. Ingredients:** Maize, Vegetable Oil, Pickled Onion Flavour, Acidity Regulator (Sodium Diacetate), **Lactose (from Milk)**, Onion Powder, Flavourings, Citric Acid, Acetic Acid, **Wheat Rusk, Hydrolysed Soya Protein (contains Wheat)**, Flavour Enhancers (Monosodium Glutamate, Disodium 5'ribonucleotide), Fructose, **Celery Seed Oil**, Mustard Seed Oil, Colours (Sulphite Ammonia Caramel), Salt, Potassium Chloride, **Wheat Flour**.
- ▣ **4 X Flamin' Hot Flavour Baked Corn Snack. Ingredients:** Maize, Vegetable Oil, Flamin Hot Flavour, **Hydrolysed Soya Protein**, Fructose, Flavourings, **Lactose (from Milk)**, Glucose Syrup, Flavour Enhancers (Monosodium Glutamate, Disodium 5'ribonucleotide), Acidity Regulator (Sodium Diacetate), Citric Acid, Tartaric Acid, **Wheat Rusk**, Sugar, Malic Acid, **Celery Seed Oil, Mustard Seed Oil**, Colours (**Sulphite Ammonia Caramel (from Wheat)**), Paprika Extract, **Curcumin (from Wheat)**, Salt, Potassium Chloride, Wheat Flour.

■ XML representation:

```

<ingredientStatement formattingPattern="
[list]
[*]
[b]5 X Pickled Onion Flavour Baked Corn Snack. Ingredients:[/b] Maize,
Vegetable Oil, Pickled Onion Flavour, Acidity Regulator (Sodium Diacetate),
[b]Lactose (from Milk)[/b], Onion Powder, Flavourings, Citric Acid, Acetic
Acid, [b]Wheat Rusk, Hydrolysed Soya Protein (contains Wheat)[/b], Flavour
Enhancers (Monosodium Glutamate, Disodium 5'ribonucleotide), Fructose,
[b]Celery Seed Oil[/b], Mustard Seed Oil, Colours (Sulphite Ammonia
Caramel), Salt, Potassium Chloride, [b]Wheat Flour[/b].
[*]
[b]4 X Flamin' Hot Flavour Baked Corn Snack. Ingredients:[b] Maize,
Vegetable Oil, Flamin Hot Flavour, [b]Hydrolysed Soya Protein[/b], Fructose,
Flavourings,[b]Lactose (from Milk)[/b], Glucose Syrup, Flavour Enhancers
(Monosodium Glutamate, Disodium 5'ribonucleotide), Acidity Regulator (Sodium
Diacetate), Citric Acid, Tartaric Acid, [b]Wheat Rusk[/b], Sugar, Malic
Acid, [b]Celery Seed Oil, Mustard Seed Oil[/b], Colours ([b]Sulphite Ammonia
Caramel (from Wheat)[/b], Paprika Extract, [b]Curcumin (from Wheat)[/b],
Salt, Potassium Chloride, Wheat Flour.
[/list]
">
5 X Pickled Onion Flavour Baked Corn Snack. Ingredients: Maize, Vegetable
Oil, Pickled Onion Flavour, Acidity Regulator (Sodium Diacetate), Lactose
(from Milk), Onion Powder, Flavourings, Citric Acid, Acetic Acid, Wheat
Rusk, Hydrolysed Soya Protein (contains Wheat), Flavour Enhancers
(Monosodium Glutamate, Disodium 5'ribonucleotide), Fructose, Celery Seed
Oil, Mustard Seed Oil, Colours (Sulphite Ammonia Caramel), Salt, Potassium
Chloride, Wheat Flour. 4 X Flamin' Hot Flavour Baked Corn Snack.
Ingredients: Maize, Vegetable Oil, Flamin Hot Flavour [Hydrolysed Soya
Protein, Fructose, Flavourings, Lactose (from Milk), Glucose Syrup, Flavour
Enhancers (Monosodium Glutamate, Disodium 5'ribonucleotide), Acidity
Regulator (Sodium Diacetate), Citric Acid, Tartaric Acid, Wheat Rusk, Sugar,
Malic Acid, Celery Seed Oil, Mustard Seed Oil, Colours (Sulphite Ammonia
Caramel (from Wheat), Paprika Extract, Curcumin (from Wheat), Salt,
Potassium Chloride, Wheat Flour.
</ingredientStatement>

```

A Food & Beverage

This section describes how the fields in the Food & Beverage (F&B) Extension should be populated. The Food & Beverage is intended to be used by trading partners in both the Food Service as well as the Food Retail sector.

A.1 Pre-Requisite

The F&B extension is based on the presumption that manufacturers / brand owners have assigned GTINs to the lowest level in the trade item hierarchy. Please be aware that even if the lowest level trade item is not marked with a barcode symbol it can still have a GTIN assigned to it. It is common practice within the Foodservice industry that the lowest level trade item (consumer unit) is not marked or assigned a GTIN. Determining the 'lowest level' of a product hierarchy is not always easy. The GTIN Management Standard says that any product that is priced or ordered or invoiced at any point in any supply chain is called a trade item and should have a GTIN assigned. For example, even if a manufacturer sells only cases of 6 catering tins of beans (and not the individual tins), if a distributor may break the case down and sell on individual tins to Foodservice operators then both the case and the tin would require GTINS (even if the Operator is not scanning barcode symbols).

Within the Foodservice Industry it is common practise, that the lowest level of a product hierarchy may still be higher than the unit which is consumed (eaten, drunk) by the end consumer. For example, a manufacturer sells a case/carton containing 4 lasagnas to a Foodservice Operator. The individual lasagnas are not marked or assigned a GTIN. Therefore, in this example all attributes will be provided at the case/carton level.

Elements marked as 'Future Core' have been approved and will be incorporated in the core item BMS in a future release in the following manner:

- **productionFacility** will be added as association to the **ManufacturerOfTradeItem** class.
- **customerSupportCentre** will be added as association to **TradingPartnerNeutralTradeItemInformation**
- **TradeItemExternalInformation** will be added as association to **TradingPartnerNeutralTradeItemInformation**

The most up to date list of valid code values is incorporated in the latest version of the F&B extension.

National authorities regulate the detailed information about the content and characteristics of food. Examples of information classes affected by such regulations are Health Claims, Ingredients, and Nutrients. The party providing food product information is expected to know and comply with the statutory regulations of the target market for which the item information is intended

A.2 When Would I Use This?

Companies that typical use the extension are (but not limited to):

- Manufacture of Food Products and Beverages
- Wholesale Trade and Commission Trade, Except of Motor Vehicles and Motorcycles
- Retail trade, Except of Motor Vehicles and Motorcycles, Repair of Personal and Household goods
- Hotels and Restaurants

The information exchanged describes the:

- Food components ('ingredients') itself
- Food components that might cause an allergic reaction
- Nutrients
- Diets in which the product fits
- Microbiological characteristics
- Physiochemical characteristics

- Issues related to preparing the product.
- Serving size and other serving related issues
- Yield of the product after preparation
- Techniques applied to preserve the product
- The applicable marketing information
- The applicable nutritional and health claims
- The link to additional information

A.3 How to use the Food & Beverage Extension

The following section describes the Food & Beverage attributes and extensions. Naming conventions follow the standards described in [Section 2](#).

A.4 Production Variant Effective Date and Production Variant Description

Attribute names are as follows:

- Production Variant Effective Date – productionVariantEffectiveDate
- Production Variant Description – productionVariantDescription

These attributes are used to exchange information on one or more production variants that differ in information but share the same allocated GTIN. This is typically the case with different package series that for the main part are identical but have slight changes in ingredient content and/or preparation instruction. Please note that the [GTIN Management Standard](#) give guidance on when a new GTIN should be allocated.

A.5 Food & Beverage Ingredient Class and Ingredient Statement

Extension names are as follows:

- Food & Beverage Ingredient Class – FoodAndBeverageIngredient
- Ingredient Statement – ingredientStatement

The Food & Beverage Extension facilitates the exchange of a structured list of individual ingredient as well as an ingredient statement in one text field. The latter is incorporated to facilitate all those trading partners that currently are not able to break down the list of ingredients per ingredient. The breakdown of the ingredient list per ingredient however is mandatory in case there is a need to enable:

- structured searches
- specification of information per ingredient (for instance the content percentage and /or country of origin)

A.6 Food & Beverage Allergen Class and Allergen Statement

Extension names are as follows:

- Food & Beverage Allergen Class – FoodAndBeverageAllergen
- Allergen Statement – allergenStatement

The Food & Beverage Extension facilitates the exchange of a structured list of individual allergens as well as an allergen statement in one text field. The latter is incorporated to exchange the allergy statement in exactly the same wording as displayed on the product label or other applicable regulations dictate

A.7 Nutrient Type Code and Unit of Measure

The field Nutrient Type Code (Food and Beverage Nutrient class) refers to the nutrient's tag name (<http://www.fao.org/home/en/>). As part of this data a quantity and measurement value is also required. Definitive unit supplied along with the tag name supersedes traditional GDS UOM pick list. From a consistency and systems point of view it would probably be easier to use the tag name so that all users apply the same unit of measure for the nutrient specified (important for smaller users where systems may not have flexibility).

A.8 Food & Beverage Module Examples

Class in core item model
Class in common library
Root class in core item model
Class in module
Attribute

Example 1: List of Individual Ingredients and Ingredient Statement

TradeItemDocument	
CatalogueItemNotification	
- creationDateTime	2011-03-11T11:00:00.000-05:00
- documentStatusCode	ORIGINAL
CatalogueItemNotificationIdentification	
- entityIdentification	20051101
ContentOwner	
- gln	8712345678913
CatalogueItem	
TradeItem	
- gtin	00074562000525
- isTradeItemABaseUnit	true
- isTradeItemAConsumerUnit	true
- isTradeItemADespatchUnit	false
- isTradeItemAnInvoiceUnit	false
- isTradeItemAnOrderableUnit	true
- tradeItemUnitDescriptorCode	BASE_UNIT_OR_EACH
InformationProviderOfTradeItem	
- gln	6612345678944
- partyName	Food Service Distributor
GdsnTradeItemClassification	
- gpcCategoryCode	10000028
TargetMarket	
- targetMarketCountryCode	124
TradeItemInformation	
Extension	
FoodAndBeverageIngredientModule	

TradeItemDocument	
AdditiveInformation	
- additiveName	Sodium Nitrate
- levelOfContainmentCode	CONTAINS
FoodAndBeverageIngredient	
- ingredientSequence	1
- ingredientName (+ languageCode)	EN, Water
FoodAndBeverageIngredient	
- ingredientSequence	2
- ingredientName (+ languageCode)	EN, Tomato paste
FoodAndBeverageIngredient	
- ingredientSequence	3
- ingredientName (+ languageCode)	EN, Tomatoes (citric acid, calcium chloride)
FoodAndBeverageIngredient	
- ingredientSequence	4
- ingredientName (+ languageCode)	EN, Carrots
FoodAndBeverageIngredient	
- ingredientSequence	5
- ingredientName (+ languageCode)	EN, Red kidney beans
FoodAndBeverageIngredient	
- ingredientSequence	6
- ingredientName (+ languageCode)	EN, Celery
FoodAndBeverageIngredient	
- ingredientSequence	7
- ingredientName (+ languageCode)	EN, Rehydrated potatoes (sodium phosphate)
FoodAndBeverageIngredient	
- ingredientSequence	8
- ingredientName (+ languageCode)	EN, Italian green beans
FoodAndBeverageIngredient	
- ingredientSequence	9
- ingredientName (+ languageCode)	EN, Penne pasta (enriched wheat flour, egg white)
FoodAndBeverageIngredient	
- ingredientSequence	10
- ingredientName (+ languageCode)	EN, Zucchini
FoodAndBeverageIngredient	
- ingredientSequence	11
- ingredientName (+ languageCode)	EN, Peas
FoodAndBeverageIngredient	
- ingredientSequence	12
- ingredientName (+ languageCode)	EN, Spinach
FoodAndBeverageIngredient	

TradeItemDocument	
- ingredientSequence	13
- ingredientName (+ languageCode)	EN, Salt
FoodAndBeverageIngredient	
- ingredientSequence	14
- ingredientName (+ languageCode)	EN, Modified corn starch
FoodAndBeverageIngredient	
- ingredientSequence	15
- ingredientName (+ languageCode)	EN, Parmesan cheese
FoodAndBeverageIngredient	
- ingredientSequence	16
- ingredientName (+ languageCode)	EN, Spice
FoodAndBeverageIngredient	
- ingredientSequence	17
- ingredientName (+ languageCode)	EN, Canola oil
FoodAndBeverageIngredient	
- ingredientSequence	18
- ingredientName (+ languageCode)	EN, Enriched wheat flour
FoodAndBeverageIngredient	
- ingredientSequence	19
- ingredientName (+ languageCode)	EN, Garlic powder
FoodAndBeverageIngredient	
- ingredientSequence	20
- ingredientName (+ languageCode)	EN, Disodium guanylate
FoodAndBeverageIngredient	
- ingredientSequence	21
- ingredientName (+ languageCode)	EN, Disodium inosinate
FoodAndBeverageIngredient	
- ingredientSequence	22
- ingredientName (+ languageCode)	EN, Parsley
DietInformationModule	
DietInformation	
- dietTypeDescription	Suitable for Gluten Free Diets
- dietTypeCode	FREE_FROM_GLUTEN
FoodAndBeveragePreparationServingModule	
- manufacturerPreparationTypeCode	UNPREPARED
PreparationServing	
- preparationTypeCode	BOIL
- convenienceLevelPercent	100
- preparationConsumptionPrecautions	Do Not Freeze

TradeItemDocument	
- servingSuggestion	As a soup, or ingredient in many of your favourite recipes. Add simple garnishes to create signature soups
ServingQuantityInformation	
- numberOfServingsPerPackage	6
- numberOfServingsPerPackageMeasurementPrecisionCode	APPROXIMATELY
NutritionalInformationModule	
- nutritionalClaim	High in Calcium
NutrientHeader	
- preparationStateCode	AS_DRAINED
- nutrientBasisQuantity	100 GRM
NutrientDetail	
- dailyValueIntakePercent	20
- measurementPrecisionCode	APPROXIMATELY
- nutrientTypeCode	FIB-
- quantityContained	GRM, 4.5
- dailyValueIntakePercent	10
- measurementPrecisionCode	APPROXIMATELY
- nutrientTypeCode	ENERC
- quantityContained	E14, 96
NutrientDetail	
- dailyValueIntakePercent	10
- measurementPrecisionCode	APPROXIMATELY
- nutrientTypeCode	FAT
- quantityContained	GRM, 0.3

Example 2: Allergen Statement

TradeItemDocument	
CatalogueItemNotification	
- creationDateTime	2011-03-11T11:00:00.000-05:00
- documentStatusCode	ORIGINAL
CatalogueItemNotificationIdentification	
- entityIdentification	20051101
ContentOwner	
- gln	8712345678913
CatalogueItem	
TradeItem	
- gtin	00074562000525
- isTradeItemABaseUnit	true
- isTradeItemAConsumerUnit	true
- isTradeItemADespatchUnit	false
- isTradeItemAnInvoiceUnit	false

TradeItemDocument	
- isTradelItemAnOrderableUnit	true
- tradelItemUnitDescriptorCode	BASE_UNIT_OR_EACH
InformationProviderOfTradelItem	
- gln	6612345678944
- partyName	Food Service Distributor
GdsnTradelItemClassification	
- gpcCategoryCode	10000028
TargetMarket	
- targetMarketCountryCode	124
TradelItemInformation	
Extension	
FoodAndBeverageIngredientModule	
TradelItemDescriptionModule	
TradelItemDescriptionInformation	
- functionalName	Soup
- productRange	Healthy Options
- tradelItemDescription (+ languageCode)	EN, Camp's Frozen Soup Homestyle Minestrone
- descriptionShort (+ languageCode)	EN, Soup
- additionalTradelItemDescription (+ languageCode)	EN, An Italian tradition full of diced carrots, kidney beans, peas and penne pasta
- variantDescription (+ languageCode)	EN, Homestyle Minestrone
BrandNameInformation	
- brandName	Camp's Frozen
PackagingMarkingModule	
- hasBatchNumber	false
- isNetContentDeclarationIndicated	true
- isPackagingMarkedReturnable	false
- isPriceOnPack	false
- packagingMarkedLabelAccreditationCode	UNIQUELY_FINNISH
FoodAndBeveragePreparationServingModule	
- manufacturerPreparationTypeCode	UNPREPARED
PreparationServing	
- preparationTypeCode	BAKE
- preparationConsumptionPrecautions	EN, Once cooked, the finished dish can be frozen in a suitable container.
- servingSuggestion	EN, EN, To Oven cook Preheat oven to 180°C (Gas Mark 4). Pan-Fry 450g boneless chicken until golden. Place chicken in a casserole dish, stir in the sauce and cover. Cook in the oven for 1 hour (or until chicken is fully cooked) If you prefer chicken pieces, use 900g and allow 10 minutes extra cooking time.
PreparationServing	
- preparationTypeCode	FRY

TradeItemDocument	
- preparationConsumptionPrecautions	EN, Once cooked, the finished dish can be frozen in a suitable container.
- servingSuggestion	EN, Pan-fry the chicken until golden. Stir in the sauce, cover and simmer for 20 minutes until the chicken is fully cooked.
ServingQuantityInformation	
- numberOfServingsPerPackage	4
FoodAndBeverageIngredientModule	
AdditiveInformation	
- additiveName	Sodium Nitrate
- levelOfContainmentCode	CONTAINS
FoodAndBeverageIngredient	
- ingredientSequence	1
- ingredientName (+ languageCode)	EN, Water
FoodAndBeverageIngredient	
- ingredientSequence	2
- ingredientName (+ languageCode)	EN, SUGAR
FoodAndBeverageIngredient	
- ingredientSequence	3
- ingredientName (+ languageCode)	EN, ONION
FoodAndBeverageIngredient	
- ingredientSequence	4
- ingredientName (+ languageCode)	EN, TOMATO PUREE
FoodAndBeverageIngredient	
- ingredientSequence	5
- ingredientName (+ languageCode)	EN, SPIRIT VINEGAR
FoodAndBeverageIngredient	
- ingredientSequence	6
- ingredientName (+ languageCode)	EN, TOMATO
FoodAndBeverageIngredient	
- ingredientSequence	7
- ingredientName (+ languageCode)	EN, GREEN PEPPERS
FoodAndBeverageIngredient	
- ingredientSequence	8
- ingredientName (+ languageCode)	EN, Italian green beans
FoodAndBeverageIngredient	
- ingredientSequence	9
- ingredientName (+ languageCode)	EN, CELERY
NutritionalInformationModule	

TradeItemDocument	
- nutritionalClaim	High in Calcium
NutrientHeader	
- preparationStateCode	UNPREPARED
- nutrientBasisQuantity	131.25 GRM
NutrientDetail	
- dailyValueIntakePercent	20
- measurementPrecisionCode	APPROXIMATELY
- nutrientTypeCode	FIB-
- quantityContained	GRM, 4.5
- dailyValueIntakePercent	10
- measurementPrecisionCode	APPROXIMATELY
- nutrientTypeCode	ENERC
- quantityContained	E14, 96
NutrientDetail	
- measurementPrecisionCode	APPROXIMATELY
- nutrientTypeCode	CHOAVL
- quantityContained	GRM, 20.8
NutrientDetail	
- measurementPrecisionCode	APPROXIMATELY
- nutrientTypeCode	SUGAR
- quantityContained	GRM,18.7
NutrientDetail	
- measurementPrecisionCode	APPROXIMATELY
- nutrientTypeCode	FAT
- quantityContained	GRM,0.1
NutrientDetail	
- measurementPrecisionCode	APPROXIMATELY
- nutrientTypeCode	FASAT
- quantityContained	MGM,0.001
NutrientDetail	
- measurementPrecisionCode	APPROXIMATELY
- nutrientTypeCode	FIB
- quantityContained	GRM,0.5
NutrientDetail	
- measurementPrecisionCode	APPROXIMATELY
- nutrientTypeCode	NA
- quantityContained	GRM,0.19
AllergenInformationModule	
AllergenRelatedInformation	
- allergenSpecificationAgency	European Union
- allergenSpecificationName	2003/89/EC

TradeItemDocument	
- allergen	
- allergenTypeCode	AP
- levelOfContainmentCode	MAY_CONTAIN
DietInformationModule	
DietInformation	
DietTypeInformation	
- dietTypeCode	VEGETARIAN
DietCertification	
- certificationAgency	UNI UK FOODS

B Fresh Foods

This section provides implementation guidance of Fresh Foods within the Global Data Synchronisation Network (GDSN).

Fresh Foods such as fish, meat, fresh produce, deli, and bakery products generally have additional data alignment requirements compared to other product categories. This is due to the following processes:

- **Production Processes;** no standard products because of lower industrialisation level and big influence of nature
- **Logistic Processes;** time and temperature handling have a big influence on the quality and appearance of the products
- **Commercial Processes;** products can be commercialised as pre-packed or bulk goods

For these reasons the following topics are identified to be particularly relevant for fresh foods products:

- Variable Measurement identification
 - Country of Origin
 - Characteristics of products of fixed and variable weight
 - Net Content
 - Net Weight
 - Brand Name
 - Product Family
 - Variety
 - Packaging Type
 - Quality
 - Category
 - Calibre
 - Breeding or growth methods
- **Note:** These factors are just one part of all the considerations that apply for fresh foods; some regions have already developed further guidelines on this area. For more information please refer to your local [GS1 Member Organisation](#).
 - **Note:** Most Fresh Foods Variable Measure Products do not have a GTIN. For more information on Variable Measure Products (Non-Food), see [Variable Measurement BMS](#).

B.1 Pre-Requisite

The Trading partners must be observing the GTIN Management Standard. For more information see [GS1 GTIN Management Standard](#).

B.2 When Would I Use This?

When implementing Fresh Foods such as fish, meat, fresh produce, deli, and bakery products.

B.3 How To?

This section describes various implementation procedures of Fresh Foods within GDSN.

B.3.1 GTIN Management Standard

It is recommended that GTIN allocation consider the primary refrigeration state of the product. When a product is regularly marketed in both chilled and frozen states, then **two GTINs should be allocated for the product**, one for each refrigeration state.

For more information please see [GS1 General Specifications](#).

B.3.2 Fixed Weight

Supplier/Producer Brand

The supplier/producer is the party responsible to assign the GTIN to the items in the hierarchy. The supplier/producer will use its GS1 company prefix and a unique number to create the GTIN for each item in the hierarchy of the product.

- **Note:** The following section contains tables illustrating how to manage the allocation of GS1 Identification keys for fresh foods products depending on factors such as hierarchy level, brand ownership, etc. Please refer to Section [X](#) for further guidance on the use and attributes for communicating Fresh Foods information through GDSN.

GTIN Retail Consumer Trade Item Unit

#	Business Requirement	Value
01	GTIN	Supplier assigned GTIN
02	isBarCodeDerivable	TRUE
03	isTradeItemAVariableUnit isTradeItemAConsumerUnit	FALSE TRUE
04	AdditionalTradeItemIdentificationType (INDUSTRY_ASSIGNED)	Not applicable
05	targetMarketCountryCode	Depending on each product
06	Height Width Depth	Depending on each product

GTIN Standard Trade Item Grouping Unit

#	Business Requirement	Value
01	GTIN	Supplier assigned GTIN.
02	isBarCodeDerivable	TRUE
03	isTradeItemAVariableUnit isTradeItemAConsumerUnit	FALSE FALSE
04	AdditionalTradeItemIdentification (INDUSTRY_ASSIGNED)	Not applicable
05	targetMarketCountryCode	Depending on each product
06	Height Width Depth	Depending on each product

- **Note:** For assistance with creating GTIN please contact your local local [GS1 Member Organisation](#).

Retailer Brand

Rule: The retailer is the party responsible to assign the GTIN to the items in the hierarchy.

The retailer will use the retailer’s GS1 company prefix and a unique number issued by the retailer to create the GTIN for each item in the hierarchy of the product. The supplier will then use this GTIN in GDSN, in marking the product, and in all communications with the retailer.

The Business Requirements and values for retailer branded GTIN Retail Consumer Trade Item Units and GTIN Standard Trace Item Grouping Units are similar to those mentioned in Section [O](#).

Generic Products (non-branded items)

Rule: For non-branded items, the supplier should be the party responsible for the assignment of the GTIN to the items in the hierarchy. This principle is very important if we want to have full traceability through all the supply chain, since merchandise coming from different suppliers has different GTINs.

The supplier will use its company prefix and a unique number to create the GTIN for each item in the hierarchy of the product.

The Business Requirements and values for non-branded GTIN Retail Consumer Trade Item Units and GTIN Standard Trace Item Grouping Units are similar to those mentioned in Section [O](#).

B.3.3 Variable Weight

Refer to [Section 7: Variable Measure Products \(Non-Food\)](#) for more information on variable weight.

Pre-packed Items

Rule: All items in the Product Hierarchy must be identified using a GTIN. Since we are dealing with variable measure items, the first digit (N1) of GTIN-14 code of non-consumer trade items must be equal to **9**. The GTIN of the retail consumer trade item must begin with a **0**.

For more information please see [GS1 General Specifications](#).

- **Note:** For variable measure trade items that are packaged for retail by the manufacturer, the GTIN used for data synchronisation purposes will be different from the barcode used to mark and sell the product at the POS. For more information please contact your local GS1 Member Organisation (MO). With the full implementation of GS1 DataBar this shall no longer apply.

Supplier/Producer Brand

Rule: The supplier/producer is the party responsible for the assignment of the GTIN to the item. The supplier/producer will use its company prefix and a unique number to create the GTIN for the product.

GTIN Retail Consumer Trade Item Unit

#	Business Requirement	Value
01	GTIN	Supplier assigned GTIN that begins with a 0
02	isBarCodeDerivable	FALSE
03	isTradeItemAVariableUnit isTradeItemAConsumerUnit	TRUE TRUE
04	AdditionalTradeItemIdentification (INDUSTRY_ASSIGNED)	See AdditionalTradeItemID Value section below.
05	targetMarketCountryCode	Depending on each product
06	Height Width Depth	Depending on each product If it is a naturally shaped product the recommendation is to measure 10 and use the average as per GS1 Package and Product Measurement Standard .

AdditionalTradeItemIdentification Value

If attribute **isTradeItemAConsumerUnit** = True, and if a trading partners requests the non-GTIN based barcode identification “master data”, then use the **AdditionalTradeItemIdentification** Code List Value **INDUSTRY_ASSIGNED** and populate the **additionalTradeItemIdentification** attribute with a 13-digit numeric value as follows:

If GTIN-12, then Fill Position One in the 13-digit field with the Digits 0

1. Fill Position Two in the 13-digit field with the GTIN Prefix 2
2. Fill positions for Commodity Codes (PLU) if Target Market Member Organization (MO) specifies.
3. **Example:** If commodity code begins in Position Seven of the GTIN-12 number, place it in Position Eight of the 13-digit field because the GTIN-12 number is filled beginning in Position Two not One
4. Fill all other positions in the 13-digit field except Position Thirteen with zeros.
5. After zero-filling, calculate Check Digit and place it in Position Thirteen.

If GTIN-13, then...

6. Fill Positions One and Two in the 13-digit field with the GTIN Prefix digits 02, 20, 21, 22, 23, 24, 25, 26, 27, 28, or 29 as specified by the GS1 Member Organisation (MO).
7. In certain target markets, the GTIN Prefix may be three or even four digits in length. In this scenario, fill Positions Three & even Four in the 13-digit field with the GTIN Prefix digits as specified by the MO
8. Fill positions for Commodity Codes (PLU) if Target Market Member Organisation (MO) specifies.
9. Fill all other positions in the 13-digit field except Position Thirteen with zeros.
10. After zero-filling, calculate Check Digit and place in Position Thirteen.

- **Note:** GTIN prefix digits **02** are recognised by the [GS1 General Specifications](#). For more information, see *Variable Measurement BMS* which is located on the [GS1 Website](#).

GTIN Standard Trade Item Grouping Unit

#	Business Requirement	Value
01	GTIN	Supplier assigned GTIN that begins with a 9
02	isBarCodeDerivable	TRUE
03	isTradeItemAVariableUnit isTradeItemAConsumerUnit	TRUE FALSE
04	AdditionalTradeItemIdentification (INDUSTRY_ASSIGNED)	Not applicable
05	targetMarketCountryCode	Depending on each product
06	Height Width Depth	Depending on each product If the measurement might be variable, the recommendation is to measure 10 and use the average as per the GS1 Package and Product Measurement Standard .

- **Note:** If it is the intention of the supplier for a trade item grouping unit to be sold at some point, in its entirety to the end consumer, then the item should be treated as retail consumer trade item unit and treated as prescribed in Section [I](#).

Retailer Brand

Rule: The retailer is the party responsible for the assignment of the GTIN to the items in the hierarchy.

The retailer will use the retailer's GS1 company prefix and a unique number issued by the retailer to create the GTIN for each item in the hierarchy of the product. The supplier will then use this GTIN in GDSN, in marking the product, and in all communications with the retailer.

The Business Requirements and values for retailer branded GTIN Retail Consumer Trade Item Units and GTIN Standard Trace Item Grouping Units are similar to those mentioned in Section [I](#).

- **Note:** In the US and Canada, Variable measure products use the UPCA Type 2 barcode, which does not contain an actual GTIN; instead it contains a commodity code and the price of the product. The retailer/brand owner does provide the commodity code to be imprinted within the UPCA Type 2 barcode. However since the GTIN is not imprinted on the EACH barcode, the manufacturer assigns a GTIN at the CASE level, and for data sync purposes may assign a GTIN at the EACH level. With the full implementation of GS1 DataBar this exception shall no longer apply.

Generic Products (Non-Branded Items)

Rule: For non-branded items, the supplier party responsible for the assignment of the GTIN to the items in the hierarchy. This principle is very important if we want to have full traceability through all the supply chain, since merchandise coming from different suppliers has different GTINs.

The supplier will use its company prefix and a unique number to create the GTIN for each item in the hierarchy of the product.

The Business Requirements and values for non-branded GTIN Retail Consumer Trade Item Units and GTIN Standard Trace Item Grouping Units are similar to those mentioned in Section [I](#).

Sold in Loose (Bulk) Items

A trade item which is without packaging at the retail level and whose quantity (the individual pieces, amount, or volume) is selected by the consumer and can be either bagged and barcoded by the consumer or bagged and key-entered or scanned at the point-of-sale.

- **Note:** In some industries these types of trade items are commonly referred to as **Bulk**.

A Loose (Bulk) food product is a product which is further "broken down", sorted, or apportioned by either the retailer before sale to consumer or the end-consumers themselves at the POS.

Examples:

- Cold meats and cheese sold in butchers and delicatessens, fudge cut from bars, loose fruit and vegetables, grains, candy, fresh produce, or snacks.
- A 10 pound case of candy sold to the retailer. The retailer puts this in bins and prices
- The "breaking down" or apportioning may be performed by the retailer, for instance at a distribution centre where meat primals are cut up and re-packaged or at a service counter within the retail location, or by the consumers themselves, for instance when consumers select from a bin of fruit.

- **Note:** Bulk products might be individually identified with a GS1 DataBar, which will affect point-of-sale procedures.

- **Note:** Bulk products may have standard dimensions at the case/trade unit level.

Fixed Weight:

Rule: Bulk items with fixed weight are identified with a regular GTIN and do not have a child.

GTIN Standard Trade Item Grouping Unit

#	Business Requirement	Value
01	GTIN	Supplier-assigned GTIN
02	isBarcodeDerivable	TRUE
03	isTradeItemAVariableUnit isTradeItemAConsumerUnit	FALSE FALSE
04	AdditionalTradeItemIdentification (INDUSTRY_ASSIGNED)	NA
05	targetMarketCountryCode	Depending on each product
06	height width depth	Depending on each product

Variable Weight:

Rule: Since items sold in bulk to retailers are variable measure items, the first digit (N1) of GTIN-14 code must be equal to "9" so they will have a Regular GTIN Starting with 9 allocated. Hierarchies may be created for Bulk items as long as individual selling units are identified with a GS1 DataBar.

GTIN Standard Trade Item Grouping Unit

#	Business Requirement	Value
01	GTIN	Supplier assigned that begins with a 9
02	isBarcodeDerivable	TRUE
03	isTradeItemAVariableUnit isTradeItemAConsumerUnit	TRUE FALSE
04	AdditionalTradeItemIdentification (INDUSTRY_ASSIGNED)	Not Applicable
05	targetMarketCountryCode	Depending on each product
06	height width depth	Depending on each product If the measurement might be variable, the recommendation is to measure 10 and use the average as per the GS1 Package and Product Measurement Standard .

Synchronising Information of Fresh Foods Products

The following section contains an overview of how to use GDSN attributes to communicate master data for fresh foods. The following section describes, when applicable, all special considerations that must be considered when dealing with fresh foods products.

Attributes for Fresh Foods

Below is a list of the attributes that have been identified by the industry as key to the synchronisation of Fresh Foods where applicable:

- globalTradeItemNumber (GTIN)
- quantityOfChildren
- quantityOfNextLowerLevelTradeItem
- totalQuantityOfNextLowerLevelTradeItem
- tradeItemUnitDescriptorCode
- gpcCategoryCode
- informationProviderOfTradeItem (gln+partyName)

- brandOwner
 - functionalName
 - tradeItemDescription
 - countryOfOrigin (countryCode+countrySubdivisionCode)
 - tradeItemFeatureBenefit
 - brandOwner (partyName)
 - manufacturerOfTradeItem (gln+ partyName)
 - sellingUnitOfMeasure
 - packagingTypeCode
 - isPackagingMarkedReturnable
 - seasonalAvailabilityEndDateTime
 - seasonalAvailabilityStartDateTime
 - handlingInstructionsCodeReference
 - growingMethodCode
 - descriptiveSizeDimension
 - netWeight
 - effectiveDateTime
 - startAvailabilityDateTime
 - endAvailabilityDateTime
 - depth
 - height
 - width
 - isTradeItemABaseUnit
 - isTradeItemAConsumerUnit
 - isTradeItemADespatchUnit
 - isTradeItemAnInvoiceUnit
 - isTradeItemAnOrderableUnit
 - isTradeItemAVariableUnit
 - maximumTemperature
 - minimumTemperature
 - productActivityTypeCode (CATCH_ZONE)
 - certificationAgency
 - certificationStandard
 - certificationValue
- **Note:** It is strongly recommended that information providers ensure that the attributes listed above are part of the information that is communicated to their trading partners when synchronising information of Fresh Foods products.
 - **Important:** While some of the attributes listed above have a specific use within Fresh Foods, most apply to Fresh Foods products in the same way that they would be used for any other type of product. Additionally, some attributes relevant for the Fresh Foods sector are already

developed on the GDSN Trade Item Implementation Guide. Whenever an entry already exists for an attribute, the corresponding chapter will be referenced; besides these, only the attributes that have a different usage within Fresh Foods are detailed below.

Trade Item Unit Descriptor

Refer to section [Overview](#) for additional information on populating this attribute.

Hierarchy and Children Information

For the attributes **quantityOfChildren**, **quantityOfNextLowerLevelTradeItem** and **totalQuantityOfNextLowerLevelTradeItem**, refer to section 4 for additional information on populating this attribute.

Product Classification (GPC)

Refer to section [Overview](#) for additional information on populating this attribute.

Brand Name

Refer to section [Overview](#) for additional information on populating this attribute.

Functional Name

This attribute will typically be used to communicate the 'commodity' (product family), such as 'oranges', 'grapes', 'chicken', 'beef', etc.

Refer to section [Overview](#) for additional information on populating this attribute.

Variant

In Fresh Foods, the attribute 'variant' will be used to express the particular variety of the product. Information providers may specify the distinguishing characteristics that differentiate similar products of the same type, brand, family and functionality.

- **Note:** An additional explanation of the products variants and characteristics can be provided through the attribute **additionalTradeItemDescription**.

Examples of how to use descriptive attributes for Fresh Foods:

The following tables contain examples of how to use descriptive attributes (**brandName**, **functionalName** and **variant**) on Fresh Foods.

Example 1: Branded Shrink-wrapped tray with apples:

Product's attribute	Attribute used in GDSN	Value
Product Family	functionalName	Apple
Brand	brandName	Healthy Harvest
Variety	variantDescription	Golden Delicious

Example 2: Unbranded sack of Lemons:

Product's attribute	Attribute used in GDSN	Value
Product Family	functionalName	Lemons
Brand	brandName	Unbranded
Variety	variantDescription	Persian

Example 3: Unbranded Grapes:

Product's attribute	Attribute used in GDSN	Value
Product Family	functionalName	Grape
Brand	brandName	Unbranded
Variety	variantDescription	Red Globe Seedless

Example 4: Branded Apples:

Product's attribute	Attribute used in GDSN	Value
Product Family	functionalName	Apple
Brand	brandName	PinkLady
Variety	variantDescription	Cripps Pink

Country of Origin

Refer to section [Trade Item Country of Origin](#) for additional information over populating this attribute.

Net Weight

Refer to section [Trade Item Country of Origin](#) for additional on Populating Net Weight.

Height, Width & Depth

Attributes will be measured according to the current [GS1 Package and Product Measurement Standard](#). Applicable tolerances are to be considered.

- **Note:** Some Fresh Foods trade units (especially bulk items) may not have a 'natural base', thus they should be measured by identifying the 'default front' (largest area with graphics or declarations) as if they were consumer products.
- **Important:** It is recommended that all measurements and weights of Variable Measure Fresh Foods products are taken by measuring a series of articles and reporting the average dimensions.

Grade of the trade item

In fresh foods, there are different types of classification schemas for the 'grade' that a trade item has. Grades are applicable to almost everything from meat and vegetables to milk and its derivatives. A grade may be defined as a composite evaluation of factors that result in a specific level of quality of the preparation or the composition of the product. In order to properly express the applicable grade that a product has, it is recommended to use the attributes '**CertificationAgency**', '**CertificationStandard**' and '**CertificationValue**'.

Through the use of these attributes, trading partners will be able to define the agency that manages the grade list, the type of grade referred and the actual grade given to the product.

Example: Meat with marbling grade of 'Prime+' as regulated by the USDA

GDSN Attribute	Value
CertificationAgency	USDA
CertificationStandard	Marbling Grades
Certification Value	Prime+

Maturity of the trade item

The communication of the maturity level/category of a trade item is sometimes required between trading partners as it can affect the pricing-point and presentation of the product to the consumer. To communicate this, the attribute **tradeItemFeatureBenefit**, may be used; this attribute allows companies to specify on free text the applicable maturity level of the product.

C Fruit & Vegetables

C.1 General Guidance

Companies whose item master lists or databases (commonly referred to in the industry as an “item master”) use “free form” product descriptions are encouraged to replace those descriptions with standardised product descriptions based on established produce attribute definitions. This will make it easier to maintain an item master list.

There are hundreds of attributes defined by GS1 today. In the guide, we have outlined attributes specific for the Fruit & Vegetables sector for GS1 members. This guide is designed to provide guidance for implementing New Item Listing of your product(s) and exchanging Master Data Attributes between trading partners.

The content of this section is fully aligned with the document published by GS1: [Fruit & Vegetables Master Data Attribute Implementation Guide](#). The content of this document has been expanded to better support the deployment of GDSN in the Fruit & Vegetables sector.

C.2 Purpose and Scope

The purpose of the Fruit & Vegetables implementation guidance is to provide best practice guidelines for industry-wide adoption for New Item Listing and update of existing assortment.

This guide provides support to companies seeking to electronically exchange fruit & vegetable product information in accordance with GS1 standards. The guidance applies to the full range of fruit & vegetable trade items. The guide outlines which attributes should be used for fruit & vegetable items and recommends best practices for the use of these standards to exchange static fruit & vegetable data between suppliers and retailers. Today, different platforms as well as different means to item identification exist when it comes to data sharing. The use of GS1 standards, specifically for Identification, Master Data Alignment, Traceability, Track and Trace, Barcode labels and EDI transactions, provides a common platform to help supply chain partners share and understand the same information about products and locations.

Attributes are used as a means to describing specific information about an item when transacting business. They reflect a certain characteristic about the item such as identifiers, weights, dimensions, and manufacturer or supplier information.

The guide outlines Industry Core Specific, Industry Commodity Required and Target Market attributes to be used by the Fresh Fruit & Vegetables industry. This guide is platform neutral and can be used with or without third party service providers. Adoption of the guidance offered in this document is voluntary and will be determined by the trading partner relationship.

The data model proposed is independent of any means used to exchange this information; the usage of the GDSN Network to exchange this data brings additional benefits to the industry. The guideline also provides the link between the data attribute and how to use it in the GDSN Network.

- **Note:** The trading of fruits & vegetables is subject to regulation in some target markets. Examples in this guideline are intended to communicate best practices for the exchange of master product data and may not include other information required by local regulation or by trading partners.

C.3 Master Data Attributes & Definitions

Master Data Attributes – The base for long term success in your business

Using the Global Trade Item Number (GTIN) is the key to a successful business. As a supplier of fruits and vegetables, you need the GTIN to uniquely identify your product. The GTIN is the key to modern electronic business processes. Single components of the GS1 system fit to each other as tools in a tool box. They can be variously combined. Producers and suppliers are able to optimise their business processes step-by-step using this GS1 tool box.

The GTIN is linked to Attributes that provide specific details of the product. Synchronising complete and accurate data attributes at the beginning of the New Item Listing process will save time and money in the end. From there, everything else falls into place such as transmitting orders, despatch advices/ASNs (Advance Shipping Notice) and electronic invoices. Mistakes can be avoided and communication to customers accelerated. All partners in the supply chain gain benefits.

There are hundreds of attributes to describe a product, however this guide points out attributes necessary for identifying fruit & vegetable products. They are broken down into three sections:

- **Industry Core Attributes** – these attributes apply to all Fruit & Vegetable commodities
 - **Industry Commodity Required Attributes** – attributes specific to a certain products
 - **Attributes not used in all Markets** – attributes which apply to certain local / regional requirement or regulations only (e.g. Target Market attributes)
- **Note:** First, when filling out a New Item Listing form or updating existing assortment, fill in the Industry Core Specific attributes. Second, fill in the Industry Commodity Required attributes. Third, fill in the Target Market attributes.

The list of attributes and definitions in the following tables are taken from the GS1 Global Data Dictionary, with some additional guidance provided for implementation, the Business Message Standard and the class in the data model where the item is defined.

C.3.1 Industry Core Attributes

Note: M – Mandatory, O – Optional, D – Dependent, N – Not applicable

M/O GDS	M/O GS1 EU F&V	Industry Core Attribute	GS1 Navigator, GDSN Attribute Module Class	Link to GS1 Navigator, GDSN Definition	Implementation Notes
M	M	Global Trade Item Number	TradeItemIdentification/gtin TradeItem	GS1 Navigator, GDSN definition	Refer to Fresh Foods GTIN Allocation Rules
M	M	Brand Name	BrandNameInformation/brandName TradeItemDescriptionModule	GS1 Navigator, GDSN definition	Different Brand Name implies a different GTIN. We may have the need to manage different languages (Russian, Greek, ...) for the brand, in addition to the brandName, the attribute to use will be: languageSpecificBrandName If there is no brand, then detail "UNBRANDED" as brandName

M/O GDS	M/O GS1 EU F&V	Industry Core Attribute	GS1 Navigator, GDSN Attribute Module Class	Link to GS1 Navigator, GDSN Definition	Implementation Notes
O	D	Produce Variety Type	produceVarietyType Fast Track Attribute		<p>It depends on the country.</p> <p>In EU, the main source of data will be the UNECE Standards http://www.unece.org/trade/agr/standard/fresh/ffv-standardse.html</p> <p>In North America, The United Kingdom, Australia, New Zealand and other countries, using the PLU name is an acceptable practice (i.e., commodity name, variety name and size). This field will have more than one value; e.g. Apple Red Delicious 2 ½ (with spaces in between the names, no commas). The current listing of PLU Codes can be found at http://www.ifpsglobal.com/Identification/PLU-Codes/PLU-codes-Search</p>
O	N	Growing Method Code	FarmingAndProcessingInformation/growingMethodCode FarmingProcessingInformationModule	GS1 Navigator, GDSN definition	<p>The recommended codes for this attribute are: CLONED_FOODS, CONVENTIONAL , FIELD_GROWN, GREENHOUSE, HYDROPONIC, INTEGRATED_PEST_MANAGEMENT, ORGANIC and SHADE_GROWN.</p> <p>When ORGANIC code is indicated, an organic claim agency code should also be provided.</p>
O	M	Trade Item Country Of Origin	PlaceOfProductActivity/countryOfOrigin PlaceOfItemActivityModule	GS1 Navigator, GDSN definition	<p>The Country of Origin is the list of all potential countries the item could be grown in. It is the actual Country of Origin for each transaction to be exchanged via transactional data. This entry should represent the actual country of origin where the item is grown. If a consumer unit contains a mix of produce from different countries, then all countries need to be listed.</p> <p>Mandatory for EU Regulations.</p> <p>ISO Code to be used, and EU and NON_EU are allowed.</p> <p>For mixed packages (EU and non-EU) use both codes EU and NON_EU.</p> <p>The GPC will be used to provide this information as well.</p> <p>For target market, the Country of Origin for EU is one country and in North America may be one or multiple countries.</p> <p>Where countries have governing regulations compliance to regulations is mandatory. Example: For EU Regulations ISO Code is used for a country origin and additional codes identify countries as EU and non-EU</p>
M	M	Functional Name	TradeItemDescriptionInformation/functionalName TradeItemDescriptionModule	GS1 Navigator, GDSN definition	



M/O GDS	M/O GS1 EU F&V	Industry Core Attribute	GS1 Navigator, GDSN Attribute	Link to GS1 Navigator, GDSN Definition	Implementation Notes
			Module		
			Class		
O	M	Packaging Type Code	Packaging/packagingTypeCode PackagingInformationModule	GS1 Navigator, GDSN definition	The description of the packaging type (packagingTypeDescription) is optional and to be provided as accurate as possible by the supplier. For an example, see section KK.8
O	O	Quantity Of Next Lower Level Trade Item	ChildTradeItem /quantityOfNextLowerLevelTradeItem TradeItem	GS1 Navigator, GDSN definition	Mandatory when describing the hierarchy of the product and the contained GTIN
O	M	Net Content & UoM (Unit of Measure)	TradeItemMeasurements /netContent TradeItemMeasurementsModule	GS1 Navigator, GDSN definition	It can be pieces, weight... The total declared weight, volume or content on the package. This field can be repeated to accommodate several values as necessary. The net content is required when the GTIN is marked as being a consumer unit. It is the sellable unit to the consumer.
M	M	Height & UoM	TradeItemMeasurements/height TradeItemMeasurementsModule	GS1 Navigator, GDSN definition	UNECE says that depending on the project, we have sizes, others do not. For some products we have sizes and for the others we have size codes provided by UNECE (size range) For all the consumer units unpacked and identified by a GTIN, the dimensions of the consumer unit are not relevant, since this information is defined by the calibre. The value of the calibre is transmitted in the field descriptive size. Since this data is mandatory in GDSN, a default value of 1 mm can be used as dummy data for this parameter. The measurement of the height of the trade item. The vertical dimension from the lowest extremity to the highest extremity, including packaging. At a pallet level, the trade item height will include the height of the pallet itself. Measurements are relative to how the customer normally views the trade item. Needs to be associated with a valid UoM.
M	M	Width & UoM	TradeItemMeasurements/width TradeItemMeasurementsModule	GS1 Navigator, GDSN definition	For all the consumer units unpacked and identified by a GTIN, the dimensions of the consumer unit are not relevant, since this information is defined by the calibre. The value of the calibre is transmitted in the field descriptive size. Since this data is mandatory in GDSN, a default value of 1 mm can be used as dummy data for this parameter. The measurement from left to right of the trade item. Measurements are relative to how the customer normally views the trade item. Needs to be associated with a valid UoM.

M/O GDS	M/O GS1 EU F&V	Industry Core Attribute	GS1 Navigator, GDSN Attribute Module Class	Link to GS1 Navigator, GDSN Definition	Implementation Notes
M	M	Depth & UoM	TradeItemMeasurements/depth TradeItemMeasurementsModule	GS1 Navigator, GDSN definition. For the measurement please see GS1 Package and Product Measurement Standard	For all the consumer units unpacked and identified by a GTIN, the dimensions of the consumer unit are not relevant, since this information is defined by the calibre. The value of the calibre is transmitted in the field descriptive size. Since this data is mandatory in GDSN, a default value of 1 mm can be used as dummy data for this parameter.
O	O	Gross Weight & UoM	TradeItemWeight/grossWeight TradeItemMeasurementsModule	GS1 Navigator, GDSN definition.	This would be the sum of the net weight of the product plus the tare weight of the packaging. See examples under the PMA Value List column for gross weight.
O	M	Trade Item Description	TradeItemDescriptionInformation/ tradeItemDescription TradeItemDescriptionModule	GS1 Navigator, GDSN definition	
M	M	Trade Item Unit Descriptor	TradeItem/tradeItemUnitDescriptor TradeItem	GS1 Navigator, GDSN definition	Code list with the following available values: <ul style="list-style-type: none"> ■ BASE_UNIT_OR_EACH ■ CASE ■ DISPLAY_SHIPPER ■ MIXED_MODULE ■ PACK_OR_INNER_PACK ■ PALLET ■ TRANSPORT_LOAD
O	O	Net Weight & UoM	TradeItemWeight/netWeight TradeItemMeasurementsModule	GS1 Navigator, GDSN definition	Does not include tare weight. In the case of a variable weight product, this would be the average weight. It is recommended that this be populated at all levels of the published hierarchy.
O	O	Quantity Of Layers Per Pallet	TradeItemHierarchy/ quantityOfLayersPerPallet TradeItemHierarchyModule	GS1 Navigator, GDSN definition	Also see Section 5, Populating TI/Hi
O	O	Quantity Of Trade Items Per Pallet Layer	TradeItemHierarchy/ quantityOfTradeItemsPerPalletLayer TradeItemHierarchyModule	GS1 Navigator, GDSN definition	Also see Section 5, Populating TI/Hi
M	M	Effective Date & Time	TradeItemSynchronisationDates/ effectiveDateTime TradeItem	GS1 Navigator, GDSN definition	

M/O GDS	M/O GS1 EU F&V	Industry Core Attribute	GS1 Navigator, GDSN Attribute		Link to GS1 Navigator, GDSN Definition	Implementation Notes
			Module			
			Class			
O	M	Brand Owner (GLN)	brandOwner/PartyInRole/gln Tradeltem		GS1 Navigator, GDSN definition	Brand owner is the party responsible for assigning the GTIN. ¹ Even if the item is unbranded, the party responsible for assigning the GTIN must be detailed.
O	M	Name Of Brand Owner	brandOwner/PartyInRole/ partyName Tradeltem		GS1 Navigator, GDSN definition	
M	M	Information Provider Of Trade Item (GLN)	informationProviderOfTradeltem/PartyInRole/gln Tradeltem		GS1 Navigator, GDSN definition	Party responsible that the data provided is correct. It will normally be the trader.
M	M	Name Of Information provider	informationProviderOfTradeltem/PartyInRole/partyName Tradeltem		GS1 Navigator, GDSN definition	
O	N	Name of Manufacturer	manufacturerOfTradeltem/ PartyInRole/partyName Tradeltem		GS1 Navigator, GDSN definition	
O	N	Manufacturer of Trade Item (GLN)	manufacturerOfTradeltem/ PartyInRole/gln Tradeltem		GS1 Navigator, GDSN definition	
M	M	Is Trade Item An Orderable Unit	IsTradeltemAnOrderableUnit Tradeltem		GS1 Navigator, GDSN definition	
M	M	Is Trade Item A Variable Unit	VariableTradeltemInformation/isTradeltemAVariableUnit VariableTradeltemInformationModule		GS1 Navigator, GDSN definition	
M	M	Is Trade Item A Base Unit	Tradeltem/isTradeltemABaseUnit Tradeltem		GS1 Navigator, GDSN definition	
M	M	Is Trade Item A Consumer Unit	Tradeltem/isTradeltemAConsumerUnit Tradeltem		GS1 Navigator, GDSN definition	
M	M	Is Trade Item A Despatch Unit	Tradeltem/isTradeltemADespatchUnit Tradeltem		GS1 Navigator, GDSN definition	
M	M	Is Trade Item An Invoice Unit	Tradeltem/isTradeltemAnInvoiceUnit Tradeltem		GS1 Navigator, GDSN definition	
M	M	Is Packaging Marked Returnable	PackagingMarking/isPackagingMarked Returnable PackagingMarkingModule		GS1 Navigator, GDSN definition	This refers to the packaging for this GTIN level, and not the product itself. This is the empty shipping container, primarily.

¹ Refer to GTIN Management Standard

M/O GDS	M/O GS1 EU F&V	Industry Core Attribute	GS1 Navigator, GDSN Attribute		Link to GS1 Navigator, GDSN Definition	Implementation Notes
			Module			
			Class			
O	O	Is Non Sold Trade Item Returnable	OrderableReturnableInformation/isNonSoldTradeItemReturnable	DeliveryPurchasingInformationModule	GS1 Navigator, GDSN definition.	
O	O	Is Trade Item Marked As Recyclable	PackagingMarking/isTradeItemMarkedAsRecyclable	PackagingMarkingModule	GS1 Navigator, GDSN definition	
O	O	Quantity Of Complete Layers Contained In Trade Item	TradeItemHierarchy/quantityOfCompleteLayersContainedInATradeItem	TradeItemHierarchyModule	GS1 Navigator, GDSN definition	Do not use this attribute unless you have assigned a GTIN to the pallet level of the hierarchy and the pallet is an orderable and invoice unit of measure. This is only populated on the Pallet GTIN. Also see Section 5, Populating TI/Hi
O	O	Quantity Of Trade Items Contained In A Complete Layer	TradeItemHierarchy/quantityOfTradeItemsContainedInACompleteLayer	TradeItemHierarchyModule	GS1 Navigator, GDSN definition	Do not use this attribute unless you have assigned a GTIN to the pallet level of the hierarchy and the pallet is an orderable and invoice unit of measure. This is only populated on the Pallet GTIN. Also see Section 5, Populating TI/Hi
O	O	Quantity Of Trade Items Per Pallet	TradeItemHierarchy/quantityOfTradeItemsPerPallet	TradeItemHierarchyModule	GS1 Navigator, GDSN definition	Also see Section 5, Populating TI/Hi
M	M	Start Availability Date Time	TradeItem /startAvailabilityDateTime	DeliveryPurchasingInformationModule	GS1 Navigator, GDSN definition	
M	M	Last Change Date Time	TradeItemSynchronisationDates/lastChangeDateTime	TradeItem	GS1 Navigator, GDSN definition	
O	O	Description Short	TradeItemDescriptionInformation /descriptionShort	TradeItemDescriptionModule	GS1 Navigator, GDSN definition	
O	O	Additional Trade Item Description	TradeItemDescriptionInformation /additionalTradeItemDescription	TradeItemDescriptionModule	GS1 Navigator, GDSN definition	
M	M	Classification Category Code	gpcCategoryCode gpcAttributeTypeCode gpcAttributeValueCode	TradeItem	GS1 Navigator, GDSN definition GS1 Navigator, GDSN definition	This is the GPC Brick Code (classificationCategoryCode). It classifies the type of produce, the category of produce and the commodity itself. The Attributes of the Bricks (eANUCCClassificationAttributeTypeCode) and the Values for the attributes (eANUCCClassificationAttributeValueCode) of the bricks are mandatory.

M/O GDS	M/O GS1 EU F&V	Industry Core Attribute	GS1 Navigator, GDSN Attribute	Link to GS1 Navigator, GDSN Definition	Implementation Notes
			Module		
			Class		
O	D	Ingredient Sequence	FoodAndBeverageIngredient /ingredientSequence FoodAndBeverageIngredientModule	GS1 Navigator, GDSN definition	For single fresh fruit & vegetable products, ingredients are not used. We could use it in variety packages to detail the ingredients of the package. If the "Ingredient Name" or "growingMethodCode" is detailed, then the "Ingredient Sequence" is mandatory.
O	O	Ingredient Name	FoodAndBeverageIngredient /ingredientName FoodAndBeverageIngredientModule	GS1 Navigator, GDSN definition	If "Ingredient Name" is used then the "Ingredient sequence" is mandatory.
O	O	Ingredient Statement	FoodAndBeverageIngredientModule/ingredientStatement FoodAndBeverageExtension FoodAndBeverageIngredientModule	GS1 Navigator, GDSN definition	
O	D	Packaging Material Code	PackagingMaterial/packagingMaterialTypeCode PackagingInformationModule	GS1 Navigator, GDSN definition	It is mandatory if the container is a returnable asset. See the code list on GDSN for "PackagingMaterialCodeList"
O	O	Display Type Code	displayTypeCode	GS1 Navigator, GDSN definition	
O	D	Organic Claim Agency	OrganicInformation/organicClaimAgencyCode FarmingAndProcessingInformationModule	GS1 Navigator, GDSN definition	It is mandatory for "ORGANIC" products. Recommended value: 6 - USDA - US Department of Agriculture
O	D	Organic Trade Item Code	OrganicInformation/OrganicClaim/organicTradeItemCode FarmingAndProcessingInformationModule	GS1 Navigator, GDSN definition	It is mandatory for "ORGANIC" products. Recommended values: 1 - Organic 5 - Not organic 6 - In conversion
O	M	Target Market Country Code	TradeItem/targetMarketCountryCode TradeItem	GS1 Navigator, GDSN definition	ISO 3166-1 Code list.
N	O	Certification Standard	certificationStandard	GS1 Navigator, GDSN definition	
N	O	Certification Agency	certificationAgency	GS1 Navigator, GDSN definition	
N	O	Certification Value	certificationValue	GS1 Navigator, GDSN definition	Default value "VALID" should be provided in this attribute
N	O	Packaging Marked Label Accreditation Code	packagingMarkedLabelAccreditationCode	GS1 Navigator, GDSN definition	

C.3.2 Industry Commodity Required Attributes

M/O GDS	M/O F&V GS1 in Eu	Industry Commodity Required Attribute	GS1 Navigator, GDSN Attribute	GS1 Navigator, GDSN Definition	Implementation notes
			Indication		
			Class		
O	D	Descriptive Size	Size/descriptiveSize TradeItemSizeModule	GS1 Navigator, GDSN definition	<p>If sizing is described for this product in any regulation, then it is mandatory.</p> <p>Priority assignment: EU Regulation 531/2011 has regulations on sizing: 10 major products to have sizing on certain products: apples ...</p> <p>For the other products, we use the Agricultural Quality Standards: UNECE/FFV or UNECE/DDP.</p> <p>Depending on the product, other standard may be applicable.</p> <p>For each commodity, there is a section "provisions for sizing". See UNECE Fresh Fruit and Vegetables Standards</p> <p>Apples: Size, or for fruit packed in rows and layers, number of units. (Size is determined either by the maximum diameter of the equatorial section or by weight.) Examples: 70-80mm, 100-120g</p> <p>Oranges: Size expressed as: Minimum and maximum sizes (in mm) or Size code(s) followed, optionally, by a minimum or maximum size or Count. Since ranges are used to define the size, it is recommended to use the "descriptiveSizeDimension"</p>
O	O	Maturity at Time of Sale	maturityatTimeofSale Fast Track Attribute	N/A	Code list: JET_FRESH READY_TO_EAT TREE_OR_VINE_RIPE

C.3.3 Attributes not used in all Markets

M/O GDS	M/O F&V GS1 in Eu	Industry Commodity Required Attribute	GS1 Navigator, GDSN Attribute	GS1 Navigator, GDSN Definition	Implementation notes
			Indication		
			Class		
O	D	Grade Code	MarketingInformation/gradeCode Reference/code MarketingInformationModule	GS1 Navigator, GDSN definition	<p>It is mandatory when the regulation establishes it.</p> <p>We recommend using the UNECE to identify the grade/class code.</p> <p>The "grade" code is used in the American market by USDA, in the European regulation, UNECE and Codex Alimentarius make reference to the "Class"</p>

M/O GDS	M/O F&V GS1 in Eu	Industry Commodity Required Attribute	GS1 Navigator, GDSN Attribute	GS1 Navigator, GDSN Definition	Implementation notes
			Indication		
			Class		
O	D	Grade Code Agency	MarketingInformation/tradeCodeReference/CodeListAgencyName MarketingInformationModule	GS1 Navigator, GDSN definition	Code list to be used: <ul style="list-style-type: none"> • USDA • UNECE • CODEX_ALIMENTARIUS • EU
O	D	Color	colourCode TradeItemDescriptionModule	GS1 Navigator, GDSN definition	If colour is described for this product in any regulation, then it is mandatory. The colorCodeValue: The code list is available in the IFPS website: http://www.ifpsglobal.com/Identification/IFPS-Color-Code-List The ColorCodeListAgencyCodeList is value "11 – IFPS" The description of the codes will be provided in different languages depending on the target market.
O	N	Commercial Type	TradeItemDescriptionInformation/variantDescription TradeItemDescriptionModule	GS1 Navigator, GDSN definition	
O	O	Rank Below Species	OrganismClassification/rankBelowSpecies OrganismClassificationModule	GS1 Navigator, GDSN definition	Example for melons: Ananas, Baskavas, Galia, Canari, Rochet ...
O	D	Inner Flesh Color Code	innerFleshColorCode Fast Track Attribute	The colour of the inner flesh usually edible part of a fruit or vegetable. Examples are pink or yellow grapefruit, orange or green for a melon. Add code values: PINK, YELLOW, GREEN, GREEN_WHITE, RED, WHITE, ORANGE, BROWN, BLACK, VIOLET, PURPLE and then use GPC color code list to broaden color Code	If colour is described for this product in any regulation, then it is mandatory. It is commodity dependent. Use the code from the code list managed by IFPS. http://www.ifpsglobal.com/Identification/IFPS-Color-Code-List

M/O GDS	M/O F&V GS1 in Eu	Industry Commodity Required Attribute	GS1 Navigator, GDSN Attribute	GS1 Navigator, GDSN Definition	Implementation notes
			Indication		
			Class		
O	O	Post Harvest Treatment Chemical Code	<p>postHarvestTreatmentChemicalCode</p> <p>Fast Track</p>	<p>Specifies if the fruit or vegetable has been treated or not post harvesting with a chemical or wax.</p> <p>GS1 Navigator, GDSN definition</p>	<p>It the item is treated, then it is mandatory to provide this information for certain commodities.</p> <p>Use the following code list: CHEMICALLY_TREATED_AFTER_HARVESTING - fruit or vegetable has been treated chemically after harvesting e.g., Treated with a Chemical Preservative NOT_TREATED_AFTER_HARVESTING - fruit or vegetable has been not been treated chemically or waxed after harvesting WAXED - fruit or vegetable has had a layer of wax applied after harvesting</p>
O	O	Post Process Trade Item Treatment Physical Code	<p>postProcessTradeItemTreatmentPhysicalCode</p> <p>Fast Track</p>	<p>Produce has gone some physical process whether altered or other physical processes after harvesting.</p> <p>GS1 Navigator, GDSN definition</p>	<p>It the item has undergone a physical treatment, it is mandatory to provide this information for certain commodities.</p> <p>Use the following code list: WASHED - produced has been cleaned by washing TRIMMED - produced has been cut or removal of parts of item, CROWN_REMOVED - product has had the plant part of itself removed e.g. the top of a pineapple PACKED_IN_ICE - produce has been packed in ice SPLIT - Produce has been cut/split into sections STEM_REMOVED - Stem of produced has been removed e.g. cherry or Broccoli LEAFLESS - produce all leaves removed e.g. celery, radish</p>
O	O	Cooking Type of Potatoes - (available in GPC only)	N/A	<p>GPC definition: Indicates, with reference to the product branding, labelling or packaging, the descriptive term that is used by the manufacturer that specifies the cooking characteristics of potatoes. For culinary purposes, varieties are often described in terms of their waxiness</p>	<p>The attribute is mandatory when describing potatoes. The attribute is part of the GPC.</p> <p>The Brick for the potatoes is: 10006104 Attributes for the potato brick (10006104): Cooking Type Of Potatoes(20002849) Country/Zone of Origin(20000743) Growing Method(20002739) Type Of Potato(20002770)</p>

M/O GDS	M/O F&V GS1 in Eu	Industry Commodity Required Attribute	GS1 Navigator, GDSN Attribute	GS1 Navigator, GDSN Definition	Implementation notes
			Indication		
			Class		
O	O	Produce Seed Presence Type Code	<p>produceSeedPresenceTypeCode</p> <p>Fast Track</p>	<p>Specifies the amount of seeds for fresh fruits and vegetables e.g. for watermelons, citrus fruits.</p>	<p>It is recommended for some commodities like: watermelon, clementine, grape...</p> <p>Code values:</p> <p>SEEDLESS – Definition: Item contains No mature Seeds or potentially a few errant seeds. The determination of this is made by the supplier and is subject to target market regulations or trade organisation guidelines.</p> <p>UNIDENTIFIED – Definition: Quantity or presence of seeds not determined</p> <p>SEEDS – Item contains the normal amount of mature seeds that are typical for this trade item. The determination of this is made by the supplier and is subject to target market regulations or trade organisation guidelines.</p> <p>ALMOST_SEEDLESS – Item contains significantly less than normal mature seeds for this particular variety. Some mature seeds will exist in trade item. The determination of this is made by the supplier and is subject to target market regulations or trade organisation guidelines.</p>
O	M	Genus	<p>OrganismClassification/Genus</p> <p>OrganismClassificationModule</p>	<p>GS1 Navigator, GDSN definition</p>	
O	D	Species	<p>OrganismClassification/Species</p> <p>OrganismClassificationModule</p>	<p>GS1 Navigator, GDSN definition</p>	<p>If the specie exists for a specific Genus, then the specie is mandatory.</p>

M/O GDS	M/O F&V GS1 in Eu	Industry Commodity Required Attribute	GS1 Navigator, GDSN Attribute	GS1 Navigator, GDSN Definition	Implementation notes
			Indication		
			Class		
O	N	Information Provider of Trade Item Additional Identification Type	PartyInRole/AdditionalTradeItemIdentification additionalTradeItemIdentificationTypeCode TradeItem	GS1 Navigator, GDSN definition	
O	N	Information Provider of Trade Item Additional Identification Value	PartyInRole/AdditionalTradeItemIdentification additionalTradeItemIdentification TradeItem	GS1 Navigator, GDSN definition	
O	D	Returnable Package Deposit Code	PackageDeposit/returnablePackageDepositIdentification PackagingInformationModule	GS1 Navigator, GDSN definition	It is mandatory if the item is delivered in a returnable package. GRAI ² of the returnable item. (explain what the GRAI is)
O	O	Returnable Package Deposit Amount	PackageDeposit/returnablePackageDepositAmount PackagingInformationModule	GS1 Navigator, GDSN definition	
O	O	Returnable Package Deposit Currency	PackageDeposit/returnablePackageDepositAmount PackagingInformationModule	GS1 Navigator, GDSN definition	It is mandatory if the Returnable Package Amount is detailed.
O	O	Trade Item Marketing Message	MarketingInformation/tradeItemMarketingMessage MarketingInformationModule	GS1 Navigator, GDSN definition	To detail premium attributes of the item. Examples: with leaves in citrus fruits, laid in layers in apples/mangos ...

C.4 Managing Equivalent Trade items in the Auction/Broker Scenario

The GTIN of a product that can be substituted for the trade item, due to supplier-defined functional equivalence to the trade item. This situation may occur in the auction/broker scenario, when GTINs to be delivered can change upon availability. Display Type Code

M/O GDSN	M/O GS1 in EU F&V	Industry Core Attribute	GS1 Navigator, GDSN Attribute	GS1 Navigator, GDSN Definition	Implementation notes GS1 in Europe
O	O	Equivalent Trade Items	referencedTradeItemTypeCode TradeItem ReferenceTradeItem	GS1 Navigator, GDSN definition	Can be repeated to accommodate different GTINs.

² For additional information on the GRAI, refer to the following:
http://www.gs1.org/sites/default/files/docs/idkeys/GS1_GRAI_Executive_Summary.pdf

C.5 Global Product Classification

The [GS1 Global Product Classification \(GPC\)](#) standard helps global trading partners to group products in the same way, everywhere in the world. The resulting common business language is clear and instantly understandable.

The building block of GPC is a product code known as a brick. GPC bricks define categories of similar products. Using the GPC brick as part of GDSN ensures the correct recognition of the product category across the extended supply chain, from seller to buyer. Bricks can be further characterised by Brick Attributes.

Example (See [Use Case #2](#)):

Picture	Industry Attribute Name	Value
	gtin	614141234561
	growingMethodCode	Conventional
	countryOfOrigin	ES
	functionalName	Watermelon
	gradeCode	II
	gradeCodeAgency	UNECE
	InnerFleshColorCode	Yellow

The equivalent in the GPC of the trade item is the following:

Segment	Food/Beverage/Tobacco (50000000)		
Family	Vegetables (Non Leaf) - Unprepared/Unprocessed (Fresh) (50260000)		
Class	Cucurbits — Inedible Peel (50260900)		
Brick	Watermelons (10006037)		
Attributes and Values of the Attributes			
Color of Flesh of Watermelon (20002802)	Country/Zone of Origin (20000743)	Growing Method (20002739)	Quality (UNECE Standard) (20002737)
Yellow (30002652)	Spain (30006788)	Conventional (30014685)	Class II (30014609)

For more information, see [GPC Standards](#).

C.6 Use Cases



Use Case examples below are meant to provide guidance when completing the attribute sheet. Not all attributes will need to be filled in for each trade item. Organisations need to determine which best fits their product(s).



- **Note:** [Use Case #1](#) and [Use Case #2](#), show all attributes. For these examples, only information pertaining to the product example has been filled in the rest are blank. In Use Case Example #3, 4, and 5, attributes that do not pertain to the product example were removed. For these examples, only attributes that are different from [Use Case #1](#) and [Use Case #2](#) are shown. Some of the attributes are in **Red** with a number next to it. This indicates further information pertaining to this attribute is below the chart.
- **Note:** The field length for UOM is a minimum of 1, maximum of 3. Currently, most values for UOM are a length of 2 (mm, cm, lb., etc.); however, the code value table "UN_Recommendation_20" has been modified to increase the value to a length of 3. As

standards are updated with the newly revised table, the length of the UOM value will increase to 3.

C.6.1 Use Case #1

Pre-packed Fixed Weight Consumer Trade Package with GTIN encoded in the barcode (EAN/UPC)

		
Industry Attribute Name	Example for Consumer Unit	Example for Case
globalTradeItemNumber	3535689284566	13535689284563
brandName	Tommy	Tommy
produceVarietyType	Campari	Campari
growingMethodCode	Conventional	Conventional
tradeItemCountryOfOrigin	Netherlands	Netherlands
functionalName	Tomatoes	Tomatoes
gradeCode	Extra	Extra
packagingTypeCode	Clam Shell	KTB (Knockdown Tote Bin/RPC)
quantityOfNextLowerLevelTradeItem	Consumer units are blank	10
netContent & UoM		5kilos
descriptiveSize	0	0
commercialType	Mini Roma	Mini Roma
height & UoM	5cm	400mm
width & UoM	6cm	300mm
depth & UoM	25cm	150mm
grossWeight & UoM		3.35kilos
Color	Red	Red
InnerFleshColorCode		
PostHarvestTreatmentChemicalCode		
PostProcessTradeItemTreatmentPhysicalCode		
cookingType		
produceSeedPresencesTypeCode		
TradeItemMarketingMessage	Burgundy Type	Burgundy Type
Genus	Solanum	Solanum
Species	Lycopersicum	Lycopersicum
gradeCodeAgency	Check code list for UNECE or FAO or EU	Check code list for UNECE or FAO or EU
gradeCodeListIdentification		
tradeItemFormDescription	Round	Round
tradeItemDescription	Tommy Cherry Tomatoes on trusses 200gm in clam shell	Tommy Cherry Tomatoes on trusses 10 x 200gm in clam shell - EPS 156
tradeItemUnitDescriptor	Base Unit or Each	Case

		
netWeight & UoM	200gm	2 kilos
quantityOfLayerPerPallet		14
quantityOfTradeItemsPerPalletLayer		10
effectiveDate	2-Dec-12	2-Dec-12
additionalTradeItemIdentificationType		
additionalTradeItemIdentificationValue		
brandOwner (GLN)	3535689290000	3535689290000
AdditionalBrandOwnerIdentificationType		
AdditionalBrandOwnerIdentificationValue		
nameOfBrandOwner	National Fruit	National Fruit
informationProviderOfTradeItem (GLN)	3535689290000	3535689290000
AdditionalInformationproviderOfTradeItemIdentificationType		
AdditionalInformationproviderOfTradeItemIdentificationValue		
nameOfInformationprovider		
nameOfManufacturer	Gardener Tommy	Gardener Tommy
manufacturer(GLN)	3535689290000	3535689290000
IsTradeItemAnOrderableUnit	No	Yes
IsTradeItemAVariableUnit	No	No
IsTradeItemABaseUnit	Yes	No
IsTradeItemAConsumerUnit	Yes	No
IsTradeItemADispatchUnit	No	Yes
IsTradeItemAnInvoiceUnit	No	Yes
IsPackagingMarkedReturnable	No	Yes
IsNonSoldTradeItemReturnable	No	No
IsTradeItemMarkedAsRecyclable	Yes	Yes
quantityOfCompleteLayersContainedInATradeItem		
quantityOfTradeItemsContainedInAComplete Layer		
quantityOfTradeItemsPerPallet	1400	140
startAvailabilityDateTime	2-Dec-12	2-Dec-12
lastChangeDateTime	10-Oct-12	10-Oct-12
descriptionShort	Tommy Roma 200gm	Tommy Roma 10 x 200gm
additionalTradeItemDescription		
classificationCategoryCode	Cherry Tomato 10006162	Cherry Tomato 10006162
IngredientSequence		
IngredientName		
IngredientStatement		
packagingMaterialCode	Plastic	Plastic
Returnable Package Deposit Code		8714548154003
Returnable Package Deposit Amount		3,86
Returnable Package Deposit Currency		Euro

displayTypeCode		
MaturityMethodAtTimeofSale		
organicTradeItemCode		
organicClaimAgency		
Target Market Country Code	372	372

Other examples could include bagged apples or bagged oranges:

Consumer Unit	Consumer Unit

C.6.2 Use Case #2

Loose / Bulk Unpacked, No Branded displayed on label of the Trade Item, Packed and Traded by Weight with a GS1 EAN/UPC or GS1 DataBar barcode (GTIN)

Industry Attribute Name	Example for Consumer Unit	Example for Bin
globalTradeItemNumber <input type="checkbox"/>	614141234561	10614141234568
brandName	Unbranded	Unbranded
produceVarietyType	Watermelon	Watermelon
growingMethodCode	Conventional	Conventional
tradeItemCountryOfOrigin	Spain	Spain
functionalName	Watermelon	Watermelon
gradeCode	II	II
gradeCodeAgency	UNECE	UNECE
packagingTypeCode	UNP (Unpacked)	Bin
quantityOfNextLowerLevelTradeItem <input type="checkbox"/>		48



Industry Attribute Name	Example for Consumer Unit	Example for Bin
netContent & UoM		240 kilos
descriptiveSize □	Medium	Medium
commercialType		
height & UoM □	12cm	1.05 meters
width & UoM □	12cm	1.0 meters
depth & UoM □	12cm	1.2 meters
grossWeight & UoM □	5 kilos	290 kilos
Color	Green	Green <i>(color is not related to the Bin but to the product)</i>
InnerFleshColorCode	Yellow	Yellow
PostHarvestTreatmentChemicalCode		
PostProcessTradeItemTreatmentPhysicalCode		
cookingType		
produceSeedPresencesTypeCode	Seedless	Seedless
TradeItemMarketingMessage		
Genus	Citrullus	Citrullus
Species	Lanatus	Lanatus
tradeItemFormDescription		
tradeItemDescription	Round Green Watermelon	Round Green Watermelon
tradeItemUnitDescriptor	Ea (Base unit or each)	Bin
netWeight & UoM	5 kilo	240 kilos
quantityOfLayerPerPallet		1
quantityOfTradeItemsPerPalletLayer		1
effectiveDate	15-Dec-12	15-Dec-12
additionalTradeItemIdentificationType	PLU	
additionalTradeItemIdentificationValue	4341	
brandOwner (GLN)	0614141100002	0614141100002
AdditionalBrandOwnerIdentificationType □	DUNS	DUNS
AdditionalBrandOwnerIdentificationValue □	1234567	1234568
nameOfBrandOwner		
informationProviderOfTradeItem(GLN)	0614141100002	0614141100002
AdditionalInformationproviderOfTradeItemIdentificationType □	DUNS	DUNS
AdditionalInformationproviderOfTradeItemIdentificationValue □	1234567	1234568
nameOfInformationprovider	Bill's Watermelon's	Bill's Watermelon's
nameOfManufacturer	Bill's Watermelon's	Bill's Watermelon's
manufacturer(GLN)	Insert Bill's GLN from 44	Insert Bill's GLN from 44

Industry Attribute Name	Example for Consumer Unit	Example for Bin
IsTradeItemAnOrderableUnit	No	Yes
IsTradeItemAVariableUnit	Yes	No
IsTradeItemABaseUnit	Yes	No
IsTradeItemAConsumerUnit	Yes	No
IsTradeItemADispatchUnit	No	Yes
IsTradeItemAnInvoiceUnit	No	Yes
IsPackagingMarkedReturnable	No	Yes
IsNonSoldTradeItemReturnable	No	No
IsTradeItemMarkedAsRecyclable	No	No
quantityOfCompleteLayersContainedInATradeItem		1
quantityOfTradeItemsContainedInACompleteLayer		1
quantityOfTradeItemsPerPallet		1
startAvailabilityDateTime	15-Dec-12	15-Dec-12
lastChangeDateTime	10-Oct-12	10-Oct-12
descriptionShort	Bill's Seedless Watermelons	Bill's Seedless Watermelons
additionalTradeItemDescription		
classificationCategoryCode	10006037 - watermelons	10006037 - watermelons
We need add the attributes		
IngredientSequence		
IngredientName		
IngredientStatement <input type="checkbox"/>		
packagingMaterialCode		97 (Triple Wall Corrugated Board)
Returnable Package Deposit Code		
Returnable Package Deposit Amount		
Returnable Package Deposit Currency		
displayTypeCode		
MaturityMethodAtTimeofSale		
organicTradeItemCode		
organicClaimAgency		
Target Market Country Code	372	372

1. Even though the product is Unbranded, it has an EAN or UPC barcode with a GTIN encoded. The GTIN is assigned by the brand owner, in this example Bill's Watermelon's
2. This is an average quantity which will vary when picked. Although quantity may vary, a number is needed. (**Note:** A new attribute may be added to indicate whether a) net quantity or b) count of next lower level of the trade item is primarily used)
3. Dependent on the market this may be a number size code
4. In this example, even though watermelons are round, estimated numbers need to be filled in

5. This is an average weight
6. This should be a GLN. If not a GLN, choose the value that best describes the identification type you're using for brand owner, in this example DUNS. This value should correlate with the number entered in AdditionalBrandOwnerIdentificationValue, e.g. DUNS
7. This is the actual number or value to the AdditionalBrandOwnerIdentificationValue, e.g. DUNS.
8. Choose the value that best describes the identification type you're using for the information provider; this value should correlate with the number entered in AdditionalInformationproviderOfTradeItemIdentificationValue, e.g. DUNS
9. This is the actual number relating to the information provider of the trade item, e.g. DUNS #
10. This attribute provides additional information such as a warning: may contain peanuts

Other examples could include: Cantaloupes or Pumpkins

Cantaloupe Each	Case of Cantaloupe	Bin of Pumpkins
		

C.6.3 Use Case #3

Pre-packed Fixed Weight Mixed Consumer Trade Package with GS1 EAN/UPC barcode (GTIN)

This is Use Case example is similar to Use Case #1 except this example is for mixed consumer products. All attributes that were similar to Use Case #1 have been removed; attributes that are different remain. The key difference is the Ingredient Sequence and Ingredient Name, since it is a mixed product this needs to be identified using these attributes. The GTIN is different since it is a different product.

		
Industry Attribute Name	Example for Consumer	Example for Case
globalTradeItemNumber	3535689298006	13535689298003
brandName	Klaus	Klaus
growingMethodCode	Organic	Organic
produceVarietyType	Thompson seedless / Palieri	Thompson seedless / Palieri
IngredientSequence	1,2	1,2
IngredientName	Red, Green Table Grapes	Red,Green Table Grapes

Other examples: mixed peppers, bagged mixed greens/salads, bagged oranges & apples:

Consumer package of mixed peppers



C.6.4 Use Case #4

Private Label Trade Item Sold by Weight with a GS1 EAN/UPC barcode (GTIN)



This example is similar to [Use Case #2](#) except in this example the Watermelons are Private Label. Again, all attributes were removed that were similar to [Use Case #2](#) and those that are different remain.

The Key differences are:

- The Brand Name is Jim’s Tasty Watermelons
- The watermelons are farmed by Bill’s Watermelons
- John’s Cooperative is the provider of the information for the New Item Listing.

This is shown through the following attributes: Brand Name, Name of Manufacturer and Name of Information Provider.

This scenario is of a Cooperative (John’s) where the farmer Bill’s) sells his product to John’s Cooperative and John’s Cooperative sells the product to multiple trading partners. In this case, they are labelling the product for a retailer (the brand owner) with the retailers’ GTIN.

		
Industry Attribute Name	Example for Consumer Unit	Example for Bin
globalTradeItemNumber	3536789378926	13536789378923
informationProviderOfTradeItem(GLN)	3534437200001	3534437200001
nameOfInformationProvider	John's Cooperative	John's Cooperative
AdditionalInformationproviderOfTradeItemIdentificationType	DUNS	DUNS
AdditionalInformationproviderOfTradeItemIdentificationValue	45678901	45678901
descriptionShort	Jim's Tasty Watermelon's (Private Label)	Jim's Tasty Watermelon's (Private Label)
manufacturer(GLN)	3538653100008	3538653100008
nameOfManufacturer	Bill's Watermelon's	Bill's Watermelon's
brandName	Jim's Tasty Watermelons (Private Label)	Jim's Tasty Watermelons (Private Label)
brandOwner (GLN)	3536789100008	3536789100008
nameOfBrandOwner	Jim's Supermarket	Jim's Supermarket
AdditionalBrandOwnerIdentificationType	DUNS	DUNS
AdditionalBrandOwnerIdentificationValue	2345678	2345678

C.6.5 Use Case #5

Loose Branded Trade Item, Packed and Traded by Weight with a GS1 DataBar barcode (GTIN)

This example is similar to [Use Case #2](#) except in this example the Watermelons are branded with Bill's Watermelons. In this example, Bill's provides all information since Bill's farm's, sells and provides all information to the trading partner for the New Item Listing. (Only the attributes which are different from [Use Case #2](#) are shown.)

- Note:** For illustration, below is an apple with a GS1 DataBar Stacked Omnidirectional barcode. Along with the GS1 DataBar barcode on the sticker, there is a human readable PLU (Price Look Up) Number. These PLU's are assigned and administered by the IFPS (International Federation of Produce Standards).



Industry Attribute Name	Example for Consumer Unit	Example for Bin
globalTrade Item Number	614141234561	10614141234568
informationProviderOfTradeItem(GLN)	0614141100002	0614141100002
nameOfInformationprovider	Bill's Watermelon's	Bill's Watermelon's
AdditionalInformationproviderOfTradeItemIdentificationType	DUNS	DUNS
AdditionalInformationproviderOfTradeItemIdentificationValue	1234567	1234568
manufacturer(GLN)	0614141100002	0614141100002
nameOfManufacturer	Bill's Watermelon's	Bill's Watermelon's
brandName	Bill's Watermelons	Bill's Watermelons
brandOwner (GLN)	0614141100002	0614141100002
nameOfBrandOwner	Bill's Watermelon's	Bill's Watermelon's
AdditionalBrandOwnerIdentificationType	DUNS	DUNS
AdditionalBrandOwnerIdentificationValue	1234567	1234567
additionalTradeItemIdentificationType ○	PLU	
additionalTradeItemIdentificationValue ○	4341	

C.6.6 Use Case #6

Loose / Bulk Unpacked Trade Item Traded by Trade Item with minimum weight No Label on the Produce



Industry Attribute Name	No Consumer Unit	Example for Case
globalTradeItemNumber		4311527003099
IsTradeItemABaseUnit		Yes
effectiveDate		21-Nov-12
informationProviderOfTradeItem(GLN)		4000000100003
nameOfInformationprovider		Vegi Cooperative
AdditionalInformationproviderOfTradeItemIdentificationType		
AdditionalInformationproviderOfTradeItemIdentificationValue		
Target Market Country Code		276
lastChangeDateTime		21-Nov-12
startAvailabilityDateTime		1-Jan-13
quantityOfNextLowerLevelTradeItem		
descriptionShort		Yellow Cherry Tomatoes
IsTradeItemADispatchUnit		Yes
IsTradeItemAnInvoiceUnit		Yes
IsTradeItemAnOrderableUnit		Yes
IsTradeItemAConsumerUnit		No
manufacturer(GLN)		4000000100003
nameOfManufacturer		Vegi Cooperative
netContent & UoM		
netWeight & UoM		3 kg
brandName		Unbranded
brandOwner (GLN)		
nameOfBrandOwner		
AdditionalBrandOwnerIdentificationType		
AdditionalBrandOwnerIdentificationValue		
TradeItemMarketingMessage		
additionalTradeItemDescription		
functionalName		Cherry tomato
classificationCategoryCode		10006162 - Cherry tomato round
IsNonSoldTradeItemReturnable		No







Industry Attribute Name	No Consumer Unit	Example for Case
IsTradelItemAVariableUnit		No
tradelItemCountryOfOrigin		Spain
organicTradelItemCode		5
growingMethodCode		Conventional
organicClaimAgency		
Color		Yellow
descriptiveSize		
additionalTradelItemIdentificationType		
additionalTradelItemIdentificationValue		
gradeCode		
gradeCodeAgency		
tradelItemFormDescription		
tradelItemDescription		
produceVarietyType		
genus		Solanum
species		lycopersicum
commercialType		Cherrytomatoes
MaturityMethodAtTimeofSale		
InnerFleshColorCode		
tradelItemUnitDescriptor		Case
PostHarvestTreatmentChemicalCode		
produceSeedPresencesTypeCode		
cookingType		
PostProcessTradelItemTreatmentPhysicalCode		
packagingTypeCode		Box
height & UoM		16cm
depth & UoM		30cm
width & UoM		40cm
grossWeight & UoM		3.5 kilo
IsPackagingMarkedReturnable		No
displayTypeCode		
IsTradelItemMarkedAsRecyclable		No
packagingMaterialCode		95
Returnable Package Deposit Code		
Returnable Package Deposit Amount		
Returnable Package Deposit Currency		
quantityOfTradelItemsPerPalletLayer		8
quantityOfTradelItemsPerPallet		128
quantityOfLayerPerPallet		16
quantityOfCompleteLayersContainedInATradelItem		
quantityOfTradelItemsContainedInACompleteLayer		
IngredientSequence		





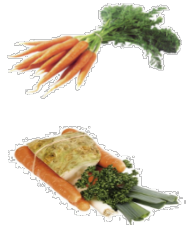

Industry Attribute Name	No Consumer Unit	Example for Case
IngredientName		
IngredientStatement		

Other example: Radishes













C.7 Packaging Type Codes





Packaging	Picture	packaging TypeCode	packagingType Description	GDSN Description	Packaging Material Code	Packaging Feature Code
Bundle		MPG	Bundle	Bundle	-	-
Cup		CU	Cup	A small bowl shaped container for beverages, often with a handle.	PLASTIC_OTH ER	-
Bucket		BJ	Bucket	A container, usually cylindrical, can be equipped with a lid and a handle. (e.g., a pail made of metal, plastic, or other appropriate material).	PLASTIC_OTH ER	-
Wrapped in Plastic		WRP	Wrapped in Plastic	Wrapped in Plastic	PLASTIC_OTH ER	-
Flowpack		WRP	Flowpack	The process of enclosing all or part of an item with layers of flexible wrapping material (e.g., for an individually packed ice cream). Does not include items that are shrink-wrapped or vacuum-packed.	PLASTIC_OTH ER	-

Packaging	Picture	packaging TypeCode	packagingType Description	GDSN Description	Packaging Material Code	Packaging Feature Code
Hamper		BK	Hamper	Hamper	PLASTIC_OTHER CORRUGATED_BOARD_OTHER WOOD_OTHER WOOD_PARTICLE_BOARD	HANDLE
Net		NT	Net	A container of meshwork material made from threads or strips twisted or woven to form a regular pattern with spaces between the threads that is used for holding, carrying, trapping, or confining something.	PLASTIC_OTHER	
Bag		BG	Bag	A preformed, flexible container, generally enclosed on all but one side, which forms an opening that may or may not be sealed after filling.	PLASTIC_OTHER	
Net with banderole		BG	Net with banderole	A preformed, flexible container, generally enclosed on all but one side, which forms an opening that may or may not be sealed after filling.	PLASTIC_OTHER COMPOSITE	LABEL
Big Box		BG	Big Box	A preformed, flexible container, generally enclosed on all but one side, which forms an opening that may or may not be sealed after filling.	PLASTIC_OTHER	-
Carrying bag		PUG	Carrying bag	A preformed, flexible container, generally enclosed on all but one side, which forms an opening that may or may not be sealed after filling.	PLASTIC_OTHER PAPER_OTHER	HANDLE

Packaging	Picture	packaging TypeCode	packagingType Description	GDSN Description	Packaging Material Code	Packaging Feature Code
Carrying package		BG	Carrying package	A preformed, flexible container, generally enclosed on all but one side, which forms an opening that may or may not be sealed after filling.	PLASTIC_OTHER PAPER_OTHER	HANDLE
Punnet		CT	Punnet	Punnet	PAPER_OTHER	-
Clamshell		CMS	Clamshell	Clamshell	PLASTIC_OTHER	-
Plastic-wrapped Tray		PU and SW	Plastic-wrapped Tray	Plastic-Wrapped Tray	PLASTIC_OTHER	WRAP
Tray with flowpack		PU	Tray with flowpack	A shallow container, which may or may not have a cover, used for displaying or carrying items.	PLASTIC_OTHER	
Basket with net		BK	Basket with net	A semi rigid container usually opened at the top traditionally used for gathering, shipping and marketing agricultural products.	PLASTIC_OTHER	WRAP

Packaging	Picture	packaging TypeCode	packagingType Description	GDSN Description	Packaging Material Code	Packaging Feature Code
Sack		ANT	Net	A container of meshwork material made from threads or strips twisted or woven to form a regular pattern with spaces between the threads that is used for holding, carrying, trapping, or confining something	PLASTIC_OTHER	WICKER_OUTER_CONTAINER
Pot		PT	Pot	A rigid container made of glass, stone, earthenware, plastic or other appropriate material with a large opening, which is used to store products, (e.g., jams, cosmetics).	PLASTIC_OTHER FIBRE_BURLAP	BASE
Open sleeve with product inside		SY	Open sleeve with product inside	A rigid container made of glass, stone, earthenware, plastic or other appropriate material with a large opening, which is used to store products, (e.g., jams, cosmetics).	PLASTIC_OTHER CERAMIC	-
Multipack		MPG	Multipack	A bundle of products held together for ease of carriage by the consumer. A multipack is always a consumer unit.	PLASTIC_OTHER PAPER_OTHER	-
Pouch		PO	Pouch	A preformed, flexible container, generally enclosed with a gusset seal at the bottom of the pack can be shaped/arranged to allow the pack to stand on shelf.	PLASTIC_OTHER COMPOSITE	-
Banderole		SY	Sleeve	A non-rigid container made of paper, cardboard or plastic that is open-ended and is slid over the contents for protection or presentation.	PLASTIC_OTHER	-
Unpacked		NE	Unpacked	The item is provided without packaging.	PAPER_OTHER	LABEL

Packaging	Picture	packaging TypeCode	packagingType Description	GDSN Description	Packaging Material Code	Packaging Feature Code
Reusable Crate		CR	Reusable Crate	A non-specific term usually referring to a rigid three-dimensional container with semi-closed faces that enclose its contents for shipment or storage. Crates could have an open or closed top and may have internal dividers. Even though some crates might be reused or become resealed. They could also be disposable depending on the product hierarchy.	-	-
Crate		CR	Crate	A non-specific term usually referring to a rigid three-dimensional container with semi-closed faces that enclose its contents for shipment or storage. Crates could have an open or closed top and may have internal dividers. Even though some crates might be reused or become resealed they could also be disposable depending on the product hierarchy.	PAPER_OTHER	LABEL
Crate (cardboard)		Carton	Crate (cardboard)	A non-specific term for a re-closable container used mostly for perishable foods (e.g. eggs, fruit).	CORRUGATED_BOARD_OTHER WOOD_OTHER WOOD_PARTICLE_BOARD	-
Carton		CT	Carton	A non-specific term for a re-closable container used mostly for perishable foods (e.g. eggs, fruit).	CORRUGATED_BOARD_OTHER	-

Packaging	Picture	packaging TypeCode	packagingType Description	GDSN Description	Packaging Material Code	Packaging Feature Code
Display		PUG	Sale Display	Packaging of the product (or products) is currently not on the list. Use this code when no suitable options are available	PLASTIC_OTHER CORRUGATED_BOARD_OTHER WOOD_OTHER	BASE
Large Crate		PB	Large Crate	A three-dimensional container which either has a pallet platform permanently attached at its base or alternatively requires a platform for its handling and storage as due to its constitution it cannot be handled without it. The characteristics of the platform should be specified using the pallet type code list.	WOOD_OTHER	-
Dinamic Shipper		PB	Dinamic Shipper	A three-dimensional container which either has a pallet platform permanently attached at its base or alternatively requires a platform for its handling and storage as due to its constitution it cannot be handled without it. The characteristics of the platform should be specified using the pallet type code list.	PLASTIC_OTHER	-
Big Maxi Crate		PB	Big Maxi Crate	A three-dimensional container which either has a pallet platform permanently attached at its base or alternatively requires a platform for its handling and storage as due to its constitution it cannot be handled without it. The characteristics of the platform should be specified using the pallet type code list.	PLASTIC_OTHER	-

Packaging	Picture	packaging TypeCode	packagingType Description	GDSN Description	Packaging Material Code	Packaging Feature Code
Cardboard Box		PB	Cardboard Box	A three-dimensional container which either has a pallet platform permanently attached at its base or alternatively requires a platform for its handling and storage as due to its constitution it cannot be handled without it. The characteristics of the platform should be specified using the pallet type code list.	CORRUGATED_BOARD_OTHER	-
Green Box		PB	Green Box	A three-dimensional container which either has a pallet platform permanently attached at its base or alternatively requires a platform for its handling and storage as due to its constitution it cannot be handled without it. The characteristics of the platform should be specified using the pallet type code list.	-	-
Pallet ISO 1		PX	Pallet ISO 1	Pallet ISO 1: Flat pallet with dimensions of 1200 x 800 mm as defined in ISO 6780.	WOOD_OTHER	-
				PalletTypeCode=11	WOOD_OTHER	-
Pallet ISO 2		PX	Pallet ISO 2	Pallet ISO 2: Flat pallet with dimensions of 1200 x 1000 mm as defined in ISO 6780.	WOOD_OTHER	-
				PalletTypeCode=12	WOOD_OTHER	-
Pallet ISO 0		PX	Pallet ISO 0	Pallet ISO 0 - 1/2 EURO Pallet: Half size flat pallet with dimensions of 800 x 600	WOOD_OTHER	-
				PalletTypeCode=10	WOOD_OTHER	-
CHEP Pallet 80 X 120 cm		PX	CHEP Pallet 80 X 120 cm	CHEP Pallet 80 X 120 cm	WOOD_OTHER	-
				PalletTypeCode=23	WOOD_OTHER	-
CHEP Pallet 80 X 60 cm		PX	CHEP Pallet 80 X 60 cm		WOOD_OTHER	-
				PalletTypeCode=	WOOD_OTHER	-
				There is no code	WOOD_OTHER	-

Packaging	Picture	packaging TypeCode	packagingType Description	GDSN Description	Packaging Material Code	Packaging Feature Code
CHEP Pallet 40 X 60 cm		PX	CHEP Pallet 40 X 60 cm	CHEP Pallet 40 X 60 cm	PLASTIC_OTH ER	-

C.8 IFPS Color Code List

Example of the IFPS code list per March 2014.

Color Code	Color Description
BLACK	Black
BLUE	Blue
BLUE_BLACK	Blue/Black
BROWN	Brown
CREAMY_YELLOW	Creamy yellow
DARK_GREEN	Dark-green
GINGER_GOLD	Ginger Gold
GOLDEN	Golden
GREEN	Green
GREEN_WHITE	Green-white
GREY	Grey
GREY_WHITE	Grey-white
MULTI-COLORED	Multi-colored
ORANGE	Orange
ORANGE_YELLOW	Orange-yellow
PEARL	Pearl
PINK	Pink
PURPLE	Purple
PURPLE_WHITE	Purple-white
RED	Red
RED_BLACK	Red/Black
RED_WHITE	Red-white
ROUGE_SALAMBO	Rouge Salambo (Red)
RUBY_RED_PINK	Ruby Red/Pink
VIOLET	Violet
WHITE	White
WHITE_GREEN	White/Green
YELLOW	Yellow
YELLOW_BROWN	Yellow/Brown
YELLOWISH	Yellowish